



# YAMAHA SUZUKI HONDA TOHATSU SELVA

FUERABORDA • OUTBOARD • FUORIBORDO • HORS-BORD

2021  
2022







# YAMAHA SUZUKI HONDA TOHATSU SELVA

FUERABORDA • OUTBOARD • FUORIBORDO • HORS-BORD

2021  
2022



[www.recambiosmarinos.es](http://www.recambiosmarinos.es)

## IMPORTANTE

LOS PRODUCTOS QUE APARECEN EN NUESTROS CATALOGOS SON VÁLIDOS Y COMPATIBLES CON LOS MOTORES Y TRANSMISIONES DE LAS MARCAS ORIGINALES QUE APARECEN EN CADA SECCIÓN. EN ALGUNOS CASOS TAMBIÉN SUMINISTRAMOS RECAMBIOS ORIGINALES. ESTA INFORMACIÓN APARECE CON LA REFERENCIA EN EL MOMENTO DE CONFIRMAR EL PEDIDO POR NUESTRA WEB. LA IMÁGENES AQUÍ CONTENIDAS PUEDEN NO CORRESPONDER CON TOTAL PRECISIÓN AL PRODUCTO SUMINISTRADO. RECAMBIOS MARINOS, S.L.U. SE RESERVA EL DERECHO DE ANULAR O CAMBIAR PRODUCTOS SIN PREVIO AVISO.

## IMPORTANT

THE PRODUCTS THAT APPEAR IN OUR CATALOGS ARE VALID AND COMPATIBLE WITH THE MOTORS AND TRANSMISSIONS OF THE ORIGINAL BRANDS THAT APPEAR IN EACH SECTION. IN SOME CASES WE ALSO SUPPLIED ORIGINAL SPARE PARTS. THIS INFORMATION APPEARS WITH THE REFERENCE AT THE TIME OF CONFIRMING THE ORDER BY OUR WEB. IMAGES CONTAINED HERE MAY NOT CORRESPOND WITH TOTAL ACCURACY TO THE PRODUCT SUPPLIED. RECAMBIOS MARINOS, S.L.U. RESERVES THE RIGHT TO CANCEL OR CHANGE PRODUCTS WITHOUT PRIOR NOTICE.

## IMPORTANTE

I PRODOTTI CHE COMPAIONO NEI NOSTRI CATALOGHI SONO VALIDI E COMPATIBILI CON I MOTORI E LE TRASMISSIONI DEI MARCHI ORIGINALI CHE APPAIONO IN OGNI SEZIONE. IN ALCUNI CASI ABBIAMO FORNITO ANCHE RICAMBI ORIGINALI. QUESTA INFORMAZIONE RISULTA CON IL RIFERIMENTO AL MOMENTO DELLA CONFERMA DELL'ORDINE DA PARTE DEL NOSTRO WEB. LE IMMAGINI QUI CONTENUTE POTREBBERO NON CORRISPONDERE ESATTAMENTE AL PRODOTTO FORNITO. RECAMBIOS MARINOS, S.L.U., SI RISERVA IL DIRITTO DI CANCELLARE O MODIFICARE I PRODOTTI SENZA PREAVVISO.

## IMPORTANT

LES PRODUITS QUI FIGURENT DANS NOS CATALOGUES SONT VALIDES ET COMPATIBLES AVEC LES MOTEURS ET LES TRANSMISSIONS DES MARQUES ORIGINALES QUI SONT PRESENTES DANS CHAQUE SECTION. DANS CERTAINS CAS NOUS FOURNISSONS EGALEMENT DES PIECES DE RECHANGE ORIGINALES. CETTE INFORMATION EST MENTIONNEE AVEC LA REFERENCE SUR NOTRE SITE WEB. LES IMAGES CONTENUES DANS CE DOCUMENT PEUVENT NE PAS CORRESPONDRE AVEC UNE PRECISION TOTALE AU PRODUIT FOURNI. RECAMBIOS MARINOS SLU SE RESERVE LE DROIT D'ANNULER OU DE MODIFIER DES PRODUITS SANS PREAVIS.

• **YAMAHA** 59  
REF --> R.O. / OEM 406

• **SUZUKI** 435  
REF --> R.O. / OEM 533

• **HONDA** 543  
REF --> R.O. / OEM 583

• **TOHATSU** 587  
REF --> R.O. / OEM 630

• **SELVA** 635  
REF --> R.O. / OEM 643

ÍNDICE accesorios	Accessories Table of contents	INDICE accessori	INDEX accessoires	
TX MARINE	TX MARINE	TX MARINE	TX MARINE	<b>4</b>
SOPORTES	STANDS	SUPPORTI	SUPPORTS	<b>8</b>
DIRECCIÓN MECÁNICA	STEERING SYSTEM	TIMONERIA MECCANICA	DIRECTION MÉCANIQUE	<b>12</b>
DIRECCIÓN HIDRÁULICA	HYDRAULICS STEERING SYSTEM	TIMONERIA IDRAULICA	DIRECTION HYDRAULIQUE	<b>14</b>
MANDOS UNIVERSALES Y ACCESORIOS	UNIVERSAL CONTROLS AND ACCESSORIES	CONTROLLI UNIVERSALI E ACCESSORI	COMMANDES UNIVERSELLES ET ACCESSORIES	<b>17</b>
SISTEMA DE GOBIERNO Y ACCESORIOS DE INSTALACIÓN	STEERING SYSTEM ET INSTALLATION ACCESSORIES	SISTEMA DI GUIDA E ACCESSORI DIREZIONE	SYSTÈME DE DIRECTION ET ACCESSORIES D'INSTALLATION	<b>20</b>
CABLES MANDOS	CONTROL CABLES	CAVI COMANDO	CÂBLES DE COMMANDE	<b>25</b>
SISTEMA DE COMBUSTIBLE	FUEL SYSTEM	SISTEMA DI COMBUSTIBILE	SYSTÈME DE CARBURANT	<b>27</b>
FILTROS DE COMBUSTIBLE	FUEL FILTERS	FILTRO BENZINA	FILTRES À CARBURAT	<b>29</b>
SISTEMA ELÉCTRICO	ELECTRIC SYSTEM	SISTEMA ELETTRICO	SYSTÈME ÉLECTRIQUE	<b>32</b>
LUBRICANTES Y PINTURAS	LUBRICANTS ET PAINTS	LUBRIFICANTI E PITTURE	LUBRIFIANTS ET PEINTURES	<b>36</b>
ACCESORIOS Y HERRAMIENTAS DE INSTALACIÓN	ACCESSORIES AND INSTALLATION TOOLS	ACCESSORI E ATTREZZI ISTALLAZIONE	ACCESSOIRES ET OUTILS D'INSTALLATION	<b>45</b>
ESTABILIZADORES, ELEVADORES Y SEGURIDAD	HYDROFOIL STABILIZER AND SECURITY	STABILIZATORI, ASCENSORI E SICUREZZA	STABILISATEURS, POWER TRIM-LIFT ET SÉCURITÉ	<b>54</b>



## AXONE NEMO

### La primera diagnosis Smart en el mundo

Axone Nemo es un potente tablet diseñado para asegurar al mecánico un óptimo uso, tanto en el entorno de taller, como en las intervenciones en el exterior.

Permite efectuar operaciones de diagnosis a gran velocidad. El chasis de magnesio le proporciona una mayor robustez y rigidez ante los golpes, muy ligero con gran capacidad de disipación de la temperatura interna.

El software operativo IDC5 destaca todas sus características, además del "touch gesture" para alcanzar en poco tiempo las funciones deseadas.

### The first Smart diagnosis in the world

Axone Nemo is a powerful tablet designed to ensure the mechanic optimal use, both in the workshop environment, as interventions abroad.

It allows to carry out diagnosis operations at high speed. The magnesium chassis provides greater robustness and rigidity against shock, very light with great capacity to dissipate the internal temperature.

The IDC5 operating software highlights all its features, in addition to the "touch gesture" to reach the desired functions in a short time.

### La prima diagnosi Smart nel mondo

Axone Nemo è un potente tablet creato per assicurare al meccanico un ottimo uso, sia nelle officine sia negli interventi all'esterno.

Permette di effettuare operazioni di diagnosi a gran velocità. La scocca in magnesio gli dona una maggior robustezza contro i colpi, molto leggero.

Il software operativo IDC5 evidenzia tutte le sue caratteristiche, come il "touch gesture" per eseguire in poco tempo le funzioni desiderate.

### Le premier outil de diagnostic intelligent au monde

Axone Nemo est une tablette puissante conçue pour assurer une utilisation mécanique optimale, aussi bien dans un atelier que lors des interventions à l'extérieur.

Il permet d'effectuer des opérations de diagnostic à grande vitesse. Le châssis en magnésium offre une plus grande robustesse contre les chocs, très léger avec une grande capacité à dissiper la température interne. Le logiciel IDC5 met en évidence toutes ses fonctionnalités.

12" (2160 x 1440)  
 Intel Quad Core N3160  
 8 GB RAM  
 250 GB  
 WIFI double channel  
 Bluetooth 4.0 Low Energy  
 2 camera x 5 Megapixels

## SOFTWARE IDC5

IDC5 es la última evolución de TEXA, gracias a la reescritura del código se incrementa la velocidad de trabajo, lo que garantiza una entrada de comunicación con la centralita casi inmediata. La nueva función "Esquemas eléctricos interactivos" permite consultar los esquemas eléctricos aprovechando las animaciones de los dispositivos implicados y generando un mapa interactivo con flujos de señales entrada o salida de centralitas.

IDC5 is the latest evolution of TEXA, thanks to the rewriting of the code the working speed is increased, which guarantees a communication input with the control unit almost immediately. The new function "Interactive electrical diagrams" allows consulting the electrical diagrams taking advantage of the animations of the devices involved and generating an interactive map with flows of signals input or output of control units.

IDC5 è l'ultima evoluzione di TEXA, grazie ai nuovi aggiornamenti, si incrementa la velocità di lavoro, che garantisce la comunicazione quasi immediata con l'unità di controllo. La nuova funzione "Diagrammi interattivi elettronici" permettono di consultare i diagrammi elettronici con l'animazione dei led generando una mappa interattiva con un flusso di segnali in entrata e in uscita della centralina.

IDC5 est la dernière évolution du célèbre logiciel TEXA, grâce à une importante réécriture du programme, la rapidité est encore augmentée, garantissant une entrée en communication presque immédiate avec les calculateurs. La nouvelle fonctionnalité appelée "Schémas Electriques Interactif" est très intéressante car elle permet de consulter les schémas électriques en exploitant les animations des dispositifs concernés et en générant une cartographie interactive avec les flux de signaux d'entrée ou de sortie des calculateurs.



Ref.				
RECAxONEMEMO	Axone Nemo	Axone Nemo	Axone Nemo	Axone Nemo
RECD06591	Navigator TXB Evolution	Navigator TXB Evolution	Navigator TXB Evolution	Navigator TXB Evolution
RECD127X0	Axone Nemo + Navigator TXB Marine	Axone Nemo + Navigator TXB	Axone Nemo + Navigator TXB	Axone Nemo + Navigator TXB
RECZ06590PC	Navigator TXB + PC	Navigator TXB + Labtop	Navigator TXB + PC	Navigator TXB + Pc portable
REC3901775	Kit maleta para guardar cables de interface	Hand case for harnesses	Kit per cavi intergaccia	Valise pour ranger les câbles d'interface
RECAGA00M1	Contrato de actualización software (y renovación anual).	Software contract and annual renovation	Contratto software (e rinnovo annuale).	Contrat de mise à jour logicielle (et renouvellement annuel).

**TEXA**

## NAVIGATOR TXB EVOLUTION & AXONE NEMO / PC



SRAM 16Mb  
MEMORY NAND Flash 8 GB  
BLUETOOTH

### NAVIGATOR TXB EVOLUTION

La evolución de la diagnosis, diseñado y desarrollado específicamente para el ambiente Marino.

Las características del hardware lo compatibilizan con todos los protocolos actualmente existentes, su conector CPC de 16 polos integrados, permite el uso de todos los cables de diagnosis. Es compatible con AXONE NEMO y PC. Gracias a la tecnología Bluetooth el técnico podrá realizar una cómoda diagnosis sin cables de por medio, incluso desde el pantalán.

Extremadamente potente, permite al mecánico una gestión fácil de los archivos de mapa. Los estándares CAN soportados incluyen la posibilidad de gestión CAN single wire y un CAN controller más para la diagnosis sobre más redes.

Permite la grabación de la sesión de diagnosis en modalidad "pruebas dinámicas", es decir con la embarcación en movimiento, para localizar averías específicas que no se podrían verificar en el amarre. La interfaz reconstruye una panorámica completa de la situación en la que la anomalía se ha verificado, proporcionando importantes elementos de análisis para identificar las causas de la avería.

The evolution of the diagnosis, designed and developed specifically for the marine environment.

The characteristics of the hardware make it compatible with all currently existing protocols, its integrated 16-pole CPC connector, allows the use of all diagnostic cables. It is compatible with AXONE NEMO and PC. Thanks to Bluetooth technology, the technician can make a comfortable diagnosis without wires, even from the jetty.

Extremely powerful, they allow the mechanic to easily manage the map files. The CAN standards supported include the possibility of CAN single wire management and a further CAN controller for the diagnosis of more networks.

It allows the recording of the diagnosis session in "dynamic tests" mode, that is to say with the boat in motion, to locate specific faults that could not be verified in the mooring. The interface reconstructs a complete panorama of the situation in which the anomaly has been verified, providing important elements of analysis to identify the causes of the failure.

L'evoluzione della diagnosi, disegnata e sviluppata specificamente per l'ambiente marino.

Le caratteristiche hardware lo rendono compatibile con tutti i protocolli attualmente esistenti, il suo connettore CPC 16 poli integrato consente l'utilizzo di tutti i cavi diagnostici. È compatibile con AXONE NEMO e PC. Grazie alla tecnologia Bluetooth il tecnico potrà realizzare una diagnosi senza cavi in mezzo, anche dal molo.

Estremamente potente, permette al meccanico una gestione facile degli archivi della mappa. Gli standard CAN supportati offrono la possibilità di gestire: CAN single wire e un altro CAN controller per eseguire le diagnosi su più reti.

Permette la registrazione di una sessione di diagnosi in modalità "prova dinamica", ovvero con l'imbarcazione in movimento, per constatare avarie specifiche che non si possono verificare in officina. La sua interfaccia permette di ricostruire una panorámica completa della situazione in cui l'anomalia si è verificata, fornendo gli elementi per identificare le eventuali avarie.

L'évolution du diagnostic, dessiner et développer spécialement pour l'environnement marin

Les caractéristiques du matériel le rendent compatible avec tous les protocoles existants, son connecteur CPC 16 pôles intégré permet l'utilisation de tous les câbles de diagnostic. Il est compatible avec Axone Nemo et Pc. Grâce à la technologie Bluetooth, le technicien peut effectuer un diagnostic sans fil, même depuis le quai. Extrêmement puissant, il permet au mécanicien de gérer facilement les fichiers des cartes. Les normes CAN prises en charge incluent la possibilité d'une gestion CAN à fil unique et un autre contrôleur CAN pour le diagnostic en réseaux. Il permet l'enregistrement de la séance de diagnostic en mode «test dynamique» c'est à dire avec le bateau en mouvement pour localiser des défauts spécifiques non vérifiables en atelier. L'interface reconstruit un panorama complet de la situation dans laquelle l'anomalie a été constatée, fournissant des éléments d'analyse importants pour identifier les causes de la panne.

Consulte la lista actualizada de aplicaciones en:

See the updated list of applications in:

Vedi l'elenco aggiornato delle applicazioni in:

Consultez la liste mise à jour des applications sur:

[www.texaiberica.com/cobertura-diagnosis](http://www.texaiberica.com/cobertura-diagnosis)

<b>MOTORES INTRABORDA</b> <b>INBOARD ENGINES</b> <b>MOTORI ENTORBORDO</b> <b>MOTEURS IN-BORD</b>	
CATERPILLAR	3196, 3176, 3126B, 3508B, 3508C, C12, C12 Acert, C18 Acert Tier 2, C32 Acert IMO II, C32 Acert Tier 2, C32 Acert Tier 2 HP, 3512 B HD, C3512B, 3512C HD, 3512C, 3516B HD, 32 Acert Tier 2 H.P. Recreational, C32 Acert Tier 3, C7, C7 Acert, C9 Acert., 3516B, 3516C HD, 3516C, C15 Acert, C6.6 Acert
CRUSADER	5.0, 5.7, 6.0, 8.1 MPI & HO MPI QSD2.0-115 / 130 / 150 / 170, QSD2.8-270 / 320 / 350, QSB5.9 / 6.7, QSC8.3, QSK19, QSL9, QSM11 (Sistema Inyección Bosch   System injection Bosch   Sistema Iniezione Bosch   Système d'injection Bosch ) Comon Rail
CUMMINS / MW	
FIAT	C13, C78, C87, GE CURSOR 250E, 350E, 400E, N40, N60, N67, S30
FNM	HPEP, HPE 80-300 HP
HYUNDAI SEASALL	D150P/S, D170J/P/S, S220P/S, S250J/P/S, U125J/P/S
ILMOR	5.7L, 6.0L, 6.2L, MV-8
INDMAR	5.7, 6.0, 8.1, Steyr 256 Diesel
KOHLER	
LOMBARDINI Marine	LDW 194 JMT, LDW 240 JMT
MAN	D2868, V8-1000, V8-1200 350, 377, 454, 496, 496MAG, 3.0L, 4.3L, 5.0L, 5.7L, 6.2L, 7.4L, 8.1L, 8.2L, TBI, MPI, Black Scorpion, Vazer, Mandos SmartCraft, D2.8D-Tronic
MERCURISER	VM D-Tronic, VM (no D-Tronic), MD2.0-115/130/150/170, MD2.8-270/320/350, TDI3.0-230/260, TDI4.2
MERCURISER Diesel	
MERCURY Racing Inbord	SCI, EFI, QC4V, 500EFI, 520, 525EFI, 540, 565, 575, 600, 850, Scorpion 377
MTU	MDEC C2
PCM MARINE Engines	5.0L, 5.7L, 6.0L, 8.1L
PERKINS	1106C-E6OTA 6.0L
SEA-DOO	Speedster, Challenger, Utopia, Islandia, Wake, Wake Speedster, Sportster
SISU AGCO	44 CTIM-2V, 49/66/74/84 CTIM-4V
STEYR MOTORS	MO306H43WJ, MO54NA33, MO84K32, MO94K33, MO114K33, MO126M28, MO144M38, MO156K25, MO164M40, MO166M28, MO174V40, MO196K35, MO236K42, MO256H45, MO256H43, MO286H43 SE126E25, SE156E26, SE196E35, SE236E40, SE236S36 SE266, SE286, SE306J38
VM MOTORI	2.8L, 4.2L D-Tronic, MD704, MD706, MR504LB
VOLKSWAGEN Marine	SDI, TDI
VOLVO PENTA	KAD, EDG, EGC, EVC, GXI, OSI, GI, GSI, OSXI, IPS, TAMD 4BY2-150 / 180, 6BY2-220 / 260 (Sistema Inyección Bosch   System injection Bosch   Sistema Iniezione Bosch   Système d'injection Bosch ) 4BY3-150/180, 4JH, 6BY3-220/260, 6LY3, 8LV-320/350/370

<b>MOTORES FUERABORDA</b> <b>OUTBOARD ENGINES</b> <b>MOTORI FUORIBORDO</b> <b>MOTEURS HORS-BORD</b>	
EVINRUDE	(90 - 250 Ficht Ram) E-Tec 25 - 300 HP, DFI
HONDA Marine	BF 40-250 HP
JOHNSON	4 Stroke
MARINER	4 Stroke, OptiMax, Verado, DFI, EFI
MERCURY	4 Stroke, OptiMax, Verado, DFI, EFI
MERCURY Racing	OPTIMAX, DSI, VERADO 400R
PARSUN	40 EFI
SELVA Marine	4 S troke EFI
SUZUKI Marine	DF 40 -300 HP
TOHATSU	MFS, BFW, BFT
YAMAHA Marine	F, T, Z 30 - 350 HP

<b>MOTOS DE AGUA</b> <b>PWC</b> <b>MOTO D'ACQUA</b> <b>SCOOTER DES MERS</b>	
HONDA Marine	Aquatrax
KAWASAKI Marine	STX, Ultra.
SEA-DOO	GTI, GTX, RXP, RXT, GTR, GTS, GTX-S, Spark, Wake Pro, Wake
YAMAHA Marine	Waverunner FX, FZR, FZS, GP, VX

**SIN CABLES DE INTERFACE**  
**WITHOUT INTERFACE CABLE**  
**SENZA CAVI INTERFACE**  
**SANS CABLES D'INTERFACE**

		<b>CABLE WIRE CAVI CÂBLE</b>
<b>REC3902417</b>	OBD, FNM Marine, VOLKSWAGEN, HYUNDAI	AM08
<b>REC3902659</b>	Marine FPT	AM11
<b>REC3904277</b>	Marine CUMMINS, MERCURISER Diesel, VM (not D-Tronic), KOHLER	AM24A
<b>REC3905159</b>	Marine VOLVO EGC 05/05>05/07	AM26
<b>REC3905286</b>	Marine MTU-MDEC	AM28
<b>REC3905397</b>	Marine CATERPILLAR, PERKINS	AM29
<b>REC3906219</b>	Marine TOHATSU	AM30
<b>REC3906891</b>	Marine MAN	AM31
<b>REC3905015</b>	Personal Water Craft KAWASAKI cable kit	



Conector redondo  
Round connector  
Connettore rotondo  
Connecteur rond

REC3905015



## INTERFACE AM01

Ref. AM01

REC3902358



CABLE  
WIRE  
CAVI  
CÂBLE

REC3902407	Marine HONDA / TOHATSU, PGM (FI)	AM02
REC3902247	Marine 2 pin MERCURY, MERCUISER	AM04
REC3902250	Marine 4 vie MERCURY, MERCUISER	AM05
REC3902413	Marine YAMAHA / SELVA	AM06
REC3902414	Marine 6 pin VOLVO PENTA	AM07
REC3902467	Marine VOLVO KAD - TAMD	AM09
REC3902864	Marine STEYR	AM12
REC3902865	Marine EVINRUDE	AM13
REC3902907	Marine VOLVO, MERCUISER (gasolina   fuel   benzina   essence), MEFI-4, 4B,3,2,1, CRUSADER	AM14
REC3902931	Marine YANMAR	AM15
REC3903560	Marine SUZUKI	AM22
REC3905265	Marine MERCUISER / VM D-Tronic	AM27
REC3908405	PARSUNS	3151/ AP54



## INTERFACE AM01CAN

Ref. AM01CAN

REC3903008



CABLE  
WIRE  
CAVI  
CÂBLE

REC3902960	Marine VOLVO, MERCUISER (gasolina   fuel   benzina   essence), MEFI-5 / EGC, ILMOR, CRUSADER, ILMOR, INDMAR, PCM (MEFI-5/EGC UBD-Msocket)	AM16
REC3903502	Marine VOLVO, EGC-EV	AM18
REC3904778	Marine MERCURY, MARINER, CUMMINS 2010+, MANDOS MCM, SMARTCRAFT	AM25
REC3907103	Marine STEYR with CAN Line protocol	AM32
REC3907642	YANMAR MARINE CAN CABLE	AM33



## KIT DIAGNOSIS Y REPROGRAMACIÓN DE LLAVE CABLE KIT FOR DIAGNOSIS AND KEY REPROGRAMMING KIT PER LA DIAGNOSI E RIPROGRAMMAZIONE DI CHIAVE KIT DE DIAGNOSTIC ET REPROGRAMATION DE CLÉ

CABLE  
WIRE  
CAVI  
CÂBLE

REC3906015 BRP Group

3151/AP43



## PUNTAS DE DERIVACIÓN REFERRAL POINTS PUNTA DI DERIVAZIONE PONTS DE DÉRIVATION

CABLE  
WIRE  
CAVI  
CÂBLE

REC3904048 AM10



Puede utilizarse con interface AM01 o AM01CAN dependiendo de la marca.

It can be used with AM01 or AM01CAN interface depending on the brand.

Può essere utilizzato con l'interfaccia AM01 o AM01CAN in base alla marca.

Peut être utilisé avec l'interface AM01 ou AM01CAN selon la marque.

## SOPORTES

## STANDS

## SUPPORTI

## SUPPORTS

### SOPORTES DESCARGA DE EMBARCACIONES

**RECH10**  
Para cargar o descargar embarcaciones de los remolques o cuna. Los remolques pueden entrar y salir de entre los gatos hidráulicos libremente, facilitando su tarea. Levantan embarcaciones de hasta 18 toneladas. Su recorrido de elevación es de 51 cm. Equipado con válvula de bloqueo que permite mantener el barco indefinidamente en la posición deseada. Puede actuar sobre tierra, grava, asfalto o cemento, tanto en la tienda, como en el varadero o exposición.

### BOAT HANDLING JACKS & STANDS

**RECH10**  
Work station for bottom repair & cleaning. Trailer rolls in out past jacks, allowing you to take boats on or off trailers easily. Jacks have an auto lock allowing boats to be left on indefinitely. Can be used on dirt, gravel, black top or cement. Can be used anywhere! Shop, yard, showroom. Lifts boats up to 40,000 lbs.

### SUPPORTI SCARICO IMBARCAZIONI

**RECH10**  
Per caricare o scaricare imbarcazioni da rimorchi o sostegni. I rimorchi possono entrare e uscire tra i crik idraulici liberamente, facilitando il compito. Solleva imbarcazioni fino a 18 tonnellate. Escursione max di 51 cm. Fornito di valvola di blocco che permette di mantenere la barca nella posizione desiderata per diverso tempi. Può essere usato su terra, ghiaia, asfalto o cemento, come in negozio o in esposizione.

### SUPPORTS DE DÉCHARGE DE BATEAU

**RECH10**  
Pour charger ou décharger des bateaux de remorques ou de berceaux. Les remorques peuvent entrer et sortir librement entre les vérins hydrauliques, ce qui facilite leur tâche. Ils lèvent des navires jusqu'à 18 tonnes. Sa course d'élévation est de 51 cm. Équipé d'une valve de blocage qui permet au navire d'être maintenu indéfiniment dans la position souhaitée. Il peut agir sur terre, gravier, asphalte ou ciment, aussi bien en magasin qu'en hangar à bateaux ou en exposition.

REF	INCLUYE	INCLUDED	INCLOSO	COMPREND
RECH10	Soportes hidráulicos	Jacks	Supporti idraulici	Supports hydrauliques x 4
	Soportes	Straight arms	Supporti	Supports x 4
	Soportes inclinados 25 cm	10" drop arms	Supporti inclinati 25 cm	Supports inclinés de 25 cm x 4
	Soportes asiento barco	4" x 18" contact pads	Supporti appoggi barche	Supports de siège de bateau x 4
RECH10-1/4	Soporte hidráulico	Jack	Supporto idraulico	Support hydraulique 1
	Soporte	Straight arm	Supporto	Support 1
	Soporte inclinados 25 cm	10" drop arms	Supporto inclinato 25 cm	Support incliné de 25 cm 1
	Soporte asiento barco	4" x 18" contact pad	Supporto appoggio barche	Support de siège de bateau 1

**RECMAR®**



REF					
REC12	Soporte plano std.	Straight support standard	Braccia piatto standard	Support plat standard	83,8 - 132 cm
	1ª posición	1st pin hole	1ª posizione	1ère position	900 kg
	2ª posición	2nd pin hole	2ª posizione	2ème position	1.800 kg
	3ª posición	3rd pin hole	3ª posizione	3ème position	3.600 kg
	4ª posición	4th pin hole	4ª posizione	4ème position	4.500 kg
REC15	Soporte inclinado	Drop arm	Braccia	Support incliné	28 cm = 10"
REC16	Soporte inclinado	Drop arm	Braccia	Support incliné	51 cm = 20"
REC17	Suplemento	Single riser extension	Suplementi	Supplement	12,5 cm = 5"
REC18	Suplemento	Single riser extension	Suplementi	Supplement	25 cm = 10"
REC19	Soporte con goma	Large pad	Braccia contatto	Support	6.800 kg +
REC20	Soporte con goma	Large pad	Braccia contatto	Support	- 6.800 kg 45.7 cm = 18"

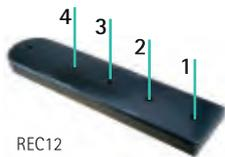

## RECAMBIOS

## SPARES

## RICAMBIO

## REPLACEMENT

REF	<b>RECMAR®</b>			
RECNSCYL	Pistón	Piston	Pistone	Vérin
REF	<b>YARDA&amp;M</b>			
YARSLKTN	Kit reparación	Repair kit	Kit riparazione	Kit de réparation
YARJAT	Rueda	Wheel	Ruota	Roue
YARNSTVALVE	Llave de recambio	Spare T key	Chiave di ricambio	Clé de rechange



YARSLKTN



RECNSCYL



YARNSTVALVE

SOPORTES PARA EMBARCACIONES	BOAT STANDS	SUPPORTI PER IMBARCAZIONI	BERS ROULANT POUR BATEAU
<p>REF</p> <p>RECED36</p> <p>1.500 kg</p>			
<p>REF</p> <p>RECED36C</p>			

SOPORTES PARA COLAS	STANDS FOR STERN DRIVES	SUPPORTI PER PIEDI	SUPPORTS D'EMBASES
<p><b>RECJO6HD</b></p> <p>Carro con gato hidráulico para la instalación de todo tipo de colas. Permite desmontar o montar colas, una sola persona. Especialmente útil en embarcaciones con plataforma integrada. Construido con brazos extra largos de sujeción y base con 4 ruedas neumáticas. Gran capacidad de elevación para colas de peso extra. También en colas de doble hélice. Varias regulaciones.</p>	<p><b>RECJO6HD</b></p> <p>Stern drive installer. Works in all makes and models. Allows one man to remove and install stern drives. Especially helpful on boats with integrated swim platforms. Built with extra long clamping arms and wheel base, plus heavyduty lifting capacity for those extra heavy drives. Also works great on dual prop drives. Unique low cost shop tool. 4 air tires allow for rugged yard use.</p>	<p><b>RECJO6HD</b></p> <p>Carro con crik idraulico per l'installazione di tutti i tipi di piedi. Permette ad una persona di smontare o montare i piedi da solo. Specialmente utile nelle imbarcazioni con piattaforma integrata. Costruito con larghi bracci di fissaggio e una base con 4 ruote pneumatiche. Grande capacità di sollevamento per piedi con peso extra. Anche per piedi con doppia elica. Varie regolazioni.</p>	<p><b>RECJO6HD</b></p> <p>Chariot avec vérin hydraulique pour l'installation de tous types d'embase. Il permet à une seule personne de démonter ou de monter des pieds. Particulièrement utile dans les bateaux avec plate-forme intégrée. Construit avec des bras de support extra longs et une base avec 4 roues pneumatiques. Grande capacité de levage pour des embases de poids important. Egalement en arbre double hélice.</p>
<p>REF</p> <p>RECJO6HD</p>			

RECAMBIOS	SPARES	RICAMBIO	REPLACEMENT	
REF				
RECKO CYL	Pistón	Piston	Pistone	Vérin
RECKRW	Rueda completa	Hydraulic jack RE-Wheel	Ruota completa	Roue complète
RECKFW	Rueda hidráulica	Hydraulic jack FT-Wheel	Ruota idraulica	Roue
RECJO10	Suplemento 25 cm	Suplement 10"	Supplemento 25 cm	Supplément de 25 cm
RECHANDLEJO6HD	Maneta	Handle	Maniglia	Poignée
RECSRINGJO6HD	Muelle	Spring	Molla	Ressort



RECKRW



RECKFW



RECHANDLEJO6HD



RECSRINGJO6HD



RECKO CYL



RECJO10

<p><b>YARSR5</b> Soporte para 5 colas. Mantiene el taller limpio y organizado. Protege las colas de golpes y daños.</p>	<p><b>YARSR5</b> Holds 5 stern drives. Keeps shop looking neat and clean. Protects drives from being cratched and damaged.</p>	<p><b>YARSR5</b> Supporto per 5 piedi. Mantiene l'officina pulita e organizzata. Protegge i piedi dai colpi e dai danni.</p>	<p><b>YARSR5</b> Prise en charge de 5 embases. Maintient l'atelier propre et organisé. Protège les pieds d'embase des chocs et des dommages.</p>
<p>REF</p> <p><b>YARSR5</b></p> <p><b>YARDARM</b></p>			
<p>REF</p> <p><b>YARSRC</b></p>			

<p><b>RECWS3</b> Soporte trabajo reparación todo tipo de colas.</p>	<p><b>RECWS3</b> Work station. Holds all kind of drives.</p>	<p><b>RECWS3</b> Supporto lavoro per riparare tutti i tipi di piedi.</p>	<p><b>RECWS3</b> Support pour les travaux de réparation de tous types d'embase.</p>
<p>REF</p> <p><b>RECWS3</b></p>			

SOPORTES PARA MOTORES	STANDS FOR ENGINES	SUPPORTI PER MOTORI	SUPPORTS MOTEUR
<p>Soporte de trabajo giratorio 360° con ruedas. Para todo tipo de motores; GM, FORD, VOLVO. Ideal para reparaciones completas.</p>	<p>Allow engine to be rotated 36 0°. Adjustable mounting plate will accommodate all engine types.</p>	<p>Carrello supporto motore, permette il movimento per 360° utile per lavorazioni in coppa. Fornito di ruote piene, può montare tutti i blocchi GM, FORD, VOLVO.</p>	<p>Support de travail rotatif à 360° avec roues. Pour tous types de moteurs; GM, FORD, VOLVO.</p>
<p>REF</p> <p><b>RECTOOL1</b></p>			

**YARES2**  
Soporte trabajo giratorio 360° con ruedas. Para todo tipo de motores: GM, FORD, VOLVO.  
Ideal para reparaciones completas. Se le pueden adaptar los soportes referencias YARCHA para GM y YARFHA para FORD y probar motores en funcionamiento.

**YARES2**  
360° rotating work support with wheels. For all types of engines: GM, FORD, VOLVO.  
Ideal for complete repairs. You can adapt the YARCHA reference supports for GM and YARFHA for FORD and test running engines.

**YARES2**  
Supporto lavoro girevole 360° con ruote. Per tutti i tipi di motori: GM, FORD, VOLVO.  
Ideale per riparazioni complete. Si possono adattare i supporti di riferimento YARCHA per GM e YARFHA per FORD e provare i motori in funzione.

**YARES2**  
Support de travail rotatif à 360° avec roues. Pour tous types de moteurs : GM, FORD, VOLVO.  
Idéal pour des réparations complètes. Vous pouvez adapter les supports de référence YARCHA pour GM et YARFHA pour FORD et tester les moteurs en cours d'exécution.

REF	
YARES2	GM, FORD, VOLVO
YARFHA	Kit FORD
YARCHA	Kit GM

**CARROS PORTAMOTOR**

Soporte portamotor con ruedas, para fueraborda. Con soporte para depósito de combustible y sandow de fijación. Fabricado en acero zincado y tablero marino de 43 cm. Diámetro ruedas: 15 cm

**OUTBOARD MOTOR CARRIER**

Manufactured in galvanized steel pipe and wooden board 43 cm. With tank holder and fixing strap. Diameter wheels: 15 cm.

**CARRELLO PORTA MOTORE**

Supporto porta motore con ruote, per fuoribordo. Con supporto per serbatoio carburante. In acciaio zincato e bordo marino da 43 cm. Diametro ruote: 15 cm

**CHARIOT MOTEUR**

Chariot-moteur avec roues, pour hors-bord. Avec support pour réservoir de carburant et fixation sandow. Fabriqué en acier galvanisé et planche marine de 43 cm. Diamètre de roue: 15 cm

Ref	KG	KG	
GS73122	12 kg	50 kg	90 cm

Soporte portamotor con ruedas, para fueraborda. Con soporte para depósito de combustible y sandow de fijación. Fabricado en acero zincado y tablero marino de 45 cm. Diámetro ruedas: 36 cm

Manufactured in galvanized steel pipe and wooden board 45 cm. With tank holder and fixing strap. Diameter wheels: 36 cm.

Supporto porta motore con ruote, per fuoribordo. Con supporto per serbatoio carburante. In acciaio zincato e bordo marino da 45 cm. Diametro ruote: 36 cm

Chariot-moteur avec roues, pour hors-bord. Avec support pour réservoir de carburant et fixation sandow. Fabriqué en acier galvanisé et panneau marin de 45 cm. Diamètre de roue: 36 cm

Ref	KG	KG	
GS73119	12 kg	80 kg	95 cm

**SOPORTE EXPOSITOR**

Soporte portamotor con ruedas, para fueraborda. Plegable. Fabricado en acero zincado y tablero marino de 43 cm.

**OUTBOARD STAND**

Folding display for outboards. Manufactured in galvanized steel pipe and wooden board of 43 cm.

**SUPPORTO ESPOSITORE**

Supporto per motori fuoribordo. Pieghevole. In acciaio zincato e bordo marino da 43 cm.

**PRÉSENTOIR**

Chariot-moteur sans roues, pour hors-bord. Pliable. Fabriqué en acier galvanisé et planche marine de 43 cm.

Ref	KG	KG	
GS73120	6 kg	40 kg	90 cm

## DIRECCIÓN MECÁNICA

## STEERING SYSTEM

## TIMONERIA MECCANICA

## DIRECTION MÉCANIQUE

### CAJA DE DIRECCIÓN AJUSTABLE ZTS

Con mecanismo antirretorno. Elimina el «feedback» de la hélice. N° vueltas babor-estribor: 3,8. Para utilizar con cables 3000 SS. Reemplaza Teleflex-Morse® NFB Safe-T II, NFB 4.2, T73BRFC

### ZTS ROTARY SINGLE HELM

Zero torque steering rotary helm. Eliminates prop feedback load. Precise response of 3.8 turns lock-to-lock. For use with the steering cables 3000 SS. Replaces Teleflex-Morse® NFB Safe-T II, NFB 4.2, T73BRFC

### TIMONERIA ZTS

Timoneria con meccanismo anti-ritorno. Elimina il feedback delle eliche. N° giri destra e sinistra: 3,8. Da utilizzare con cavi: 3000 SS. Rimpiazza TeleflexMorse®NFB Safe-T II, NFB 4.2, T73BRFC

### BOÎTIER DE DIRECTION ZTS

Avec mécanisme anti-retour. Élimine le "retour" de l'hélice. Nombre de tours bâbord-tribord: 3.8. Utilisation avec les câbles 3000 SS. Remplace Teleflex-Morse® NFB Safe-T II, NFB 4.2, T73BRFC

REF				
PRE500010	Caja de dirección	Helm	Timoneria	Boitier de direction
PRE500012	Ménsula de montaje 90°	Bezel kit 90°	Coprizzo 90°	Support incliné 90°
PRE500014	Ménsula de montaje 20°	Bezel kit 20°	Coprizzo 20°	Support incliné 20°



PRE500012



PRE500014



PRE500010

Caja de dirección con sistema de ángulo ajustable hasta 40°. Se acomoda la postura de conducción más idónea para el piloto.

Tilt rotary steering system to use with the steering cables 3000 SS. With full 40 degree range of motion.

Timoneria con sistema di angolo fino a 40°. Si può impostare la posizione più idonea di guida per il pilota.

Boîtier de direction avec système d'angle réglable jusqu'à 40°. Permet d'obtenir la position de conduite la plus appropriée pour le pilote.

REF	
PRE500007	ZTS
PRE370987	3000



PRE500007



PRE370987

### KIT LT

### KIT LT

### KIT LT

### KIT LT

Compuesto por 1 caja operadora, 1 cable de dirección según las medidas indicadas y un bisel de montaje de 90°. Radio mínimo curvatura del cable 360°. Carrera del cable 230 mm con 2,5 vueltas de volante

Rotary steering system: Helm, Steering cable and 90° bezel. Travel 230 mm.

Composto da una timoneria, 1 cavo timoneria secondo le dimensioni indicate e una piastra da 90°. Raggio minimo curvatura del cavo 360°. Corsa cavo 230mm con 2,5 giri del volante.

Composé d'un boîtier de commande, d'un câble de direction selon les mesures indiquées et d'un support incliné à 90°. Course du câble 230 mm avec 2,5 tours de volant

REF	Scale	Boat	HP
PRE208005	5' / 1,50 m	5,5 m	55 hp
PRE208006	6' / 1,80 m		
PRE208007	7' / 2,10 m		
PRE208008	8' / 2,45 m		
PRE208009	9' / 2,75 m		
PRE208010	10' / 3,05 m		

REF	Scale	Boat	HP
PRE208011	11' / 3,35 m	5,5 m	55 hp
PRE208012	12' / 3,65 m		
PRE208013	13' / 3,95 m		
PRE208014	14' / 4,25 m		
PRE208015	15' / 4,60 m		
PRE208016	16' / 4,90 m		



steerflex



KIT 3000 SS	KIT 3000 SS	KIT 3000 SS	KIT 3000 SS
<p>Compuesto por 1 caja operadora, 1 cable de dirección fabricado en acero inox según medidas indicadas y un bisel de montaje de 90°.</p> <p>Para embarcaciones con un esfuerzo máximo de 140 kg en el punto de unión. Puede montarse en cualquier posición con movimientos de 90°.</p> <p>Radio mínimo curvatura del cable 200 mm. Carrera del cable 230 mm con 3,6 vueltas de volante</p> <p>Reemplaza Teleflex-Morse® Safe-T QC, Safe-T, Uflex T71FC</p>	<p>Rotary steering system: Helm, Stainless Steel Cable and 90° Bezel.</p> <p>Stainless steel inner cable with spring stainless steel enclosure coil.</p> <p>Maximum working load: 300 lb at the tiller arm.</p> <p>Three turns lock to lock. Travel 230 mm.</p> <p>Replaces Teleflex-Morse® Safe-T QC, Safe-T, Uflex T71FC</p>	<p>Composto da una timoneria, 1 cavo timoneria in acciaio inox, secondo le misure richieste e una piastra di montaggio di 90°.</p> <p>Per imbarcazioni con uno sforzo massimo di 140kg nel punto di unione.</p> <p>Si può montare in qualunque posizione con un movimento di 90°. Raggio minimo curvatura 200mm.</p> <p>Corsa del cavo 230mm con 3,6 giri del volante.</p> <p>Rimpiazza Teleflex-Morse® Safe-T QC, Safe-T, Uflex T71FC</p>	<p>Composé de 1 boîtier de commande, 1 câble de direction en acier inoxydable selon les mesures indiquées et un support incliné à 90°.</p> <p>Pour les bateaux avec un effort maximum de 140 kg au point de jonction.</p> <p>Course du câbles 230 mm avec 3,6 tours de volant</p> <p>Remplace Teleflex-Morse® Safe-T QC, Safe-T, Uflex T71FC</p>

REF		
PRE315008	8' / 2,45 m	8 m
PRE315009	9' / 2,75 m	
PRE315010	10' / 3,05 m	
PRE315011	11' / 3,35 m	
PRE315012	12' / 3,65 m	
PRE315013	13' / 3,95 m	
PRE315014	14' / 4,25 m	

REF		
PRE315015	15' / 4,60 m	8 m
PRE315016	16' / 4,90 m	
PRE315017	17' / 5,20 m	
PRE315018	18' / 5,50 m	
PRE315019	19' / 5,80 m	
PRE315020	20' / 6,10 m	



CABLES DE DIRECCIÓN LT	LT STEERING CABLE	CAVO DI TIMONERIA LT	CÂBLES DE DIRECTION LT																												
<table border="1"> <thead> <tr> <th>REF</th> <th></th> </tr> </thead> <tbody> <tr><td>PRE250005</td><td>5' / 1,50 m</td></tr> <tr><td>PRE250006</td><td>6' / 1,80 m</td></tr> <tr><td>PRE250007</td><td>7' / 2,10 m</td></tr> <tr><td>PRE250008</td><td>8' / 2,45 m</td></tr> <tr><td>PRE250009</td><td>9' / 2,75 m</td></tr> <tr><td>PRE250010</td><td>10' / 3,05 m</td></tr> </tbody> </table>	REF		PRE250005	5' / 1,50 m	PRE250006	6' / 1,80 m	PRE250007	7' / 2,10 m	PRE250008	8' / 2,45 m	PRE250009	9' / 2,75 m	PRE250010	10' / 3,05 m	<table border="1"> <thead> <tr> <th>REF</th> <th></th> </tr> </thead> <tbody> <tr><td>PRE250011</td><td>11' / 3,35 m</td></tr> <tr><td>PRE250012</td><td>12' / 3,65 m</td></tr> <tr><td>PRE250013</td><td>13' / 3,95 m</td></tr> <tr><td>PRE250014</td><td>14' / 4,25 m</td></tr> <tr><td>PRE250015</td><td>15' / 4,60 m</td></tr> <tr><td>PRE250016</td><td>16' / 4,90 m</td></tr> </tbody> </table>	REF		PRE250011	11' / 3,35 m	PRE250012	12' / 3,65 m	PRE250013	13' / 3,95 m	PRE250014	14' / 4,25 m	PRE250015	15' / 4,60 m	PRE250016	16' / 4,90 m		
REF																															
PRE250005	5' / 1,50 m																														
PRE250006	6' / 1,80 m																														
PRE250007	7' / 2,10 m																														
PRE250008	8' / 2,45 m																														
PRE250009	9' / 2,75 m																														
PRE250010	10' / 3,05 m																														
REF																															
PRE250011	11' / 3,35 m																														
PRE250012	12' / 3,65 m																														
PRE250013	13' / 3,95 m																														
PRE250014	14' / 4,25 m																														
PRE250015	15' / 4,60 m																														
PRE250016	16' / 4,90 m																														

CABLES DE DIRECCIÓN 3000 SS DE ACERO INOX	STEERING CABLE 3000 SS STAINLESS STEEL	CAVO TIMONERIA 3000 SS ACCIAIO INOX	CÂBLES DE DIRECTION 3000 SS ACIER INOXYDABLE																																										
<table border="1"> <thead> <tr> <th>REF</th> <th></th> </tr> </thead> <tbody> <tr><td>PRE550008</td><td>8' / 2,45 m</td></tr> <tr><td>PRE550009</td><td>9' / 2,75 m</td></tr> <tr><td>PRE550010</td><td>10' / 3,05 m</td></tr> <tr><td>PRE550011</td><td>11' / 3,35 m</td></tr> <tr><td>PRE550012</td><td>12' / 3,65 m</td></tr> <tr><td>PRE550013</td><td>13' / 3,95 m</td></tr> <tr><td>PRE550014</td><td>14' / 4,25 m</td></tr> <tr><td>PRE550015</td><td>15' / 4,60 m</td></tr> <tr><td>PRE550016</td><td>16' / 4,90 m</td></tr> <tr><td>PRE550017</td><td>17' / 5,20 m</td></tr> </tbody> </table>	REF		PRE550008	8' / 2,45 m	PRE550009	9' / 2,75 m	PRE550010	10' / 3,05 m	PRE550011	11' / 3,35 m	PRE550012	12' / 3,65 m	PRE550013	13' / 3,95 m	PRE550014	14' / 4,25 m	PRE550015	15' / 4,60 m	PRE550016	16' / 4,90 m	PRE550017	17' / 5,20 m	<table border="1"> <thead> <tr> <th>REF</th> <th></th> </tr> </thead> <tbody> <tr><td>PRE550018</td><td>18' / 5,50 m</td></tr> <tr><td>PRE550019</td><td>19' / 5,80 m</td></tr> <tr><td>PRE550020</td><td>20' / 6,10 m</td></tr> <tr><td>PRE550021</td><td>21' / 6,40 m</td></tr> <tr><td>PRE550022</td><td>22' / 6,70 m</td></tr> <tr><td>PRE550023</td><td>23' / 7,00 m</td></tr> <tr><td>PRE550024</td><td>24' / 7,30 m</td></tr> <tr><td>PRE550025</td><td>25' / 7,60 m</td></tr> <tr><td>PRE550026</td><td>26' / 7,90 m</td></tr> </tbody> </table>	REF		PRE550018	18' / 5,50 m	PRE550019	19' / 5,80 m	PRE550020	20' / 6,10 m	PRE550021	21' / 6,40 m	PRE550022	22' / 6,70 m	PRE550023	23' / 7,00 m	PRE550024	24' / 7,30 m	PRE550025	25' / 7,60 m	PRE550026	26' / 7,90 m		
REF																																													
PRE550008	8' / 2,45 m																																												
PRE550009	9' / 2,75 m																																												
PRE550010	10' / 3,05 m																																												
PRE550011	11' / 3,35 m																																												
PRE550012	12' / 3,65 m																																												
PRE550013	13' / 3,95 m																																												
PRE550014	14' / 4,25 m																																												
PRE550015	15' / 4,60 m																																												
PRE550016	16' / 4,90 m																																												
PRE550017	17' / 5,20 m																																												
REF																																													
PRE550018	18' / 5,50 m																																												
PRE550019	19' / 5,80 m																																												
PRE550020	20' / 6,10 m																																												
PRE550021	21' / 6,40 m																																												
PRE550022	22' / 6,70 m																																												
PRE550023	23' / 7,00 m																																												
PRE550024	24' / 7,30 m																																												
PRE550025	25' / 7,60 m																																												
PRE550026	26' / 7,90 m																																												

CABLES DE DIRECCIÓN MEGA-UR	MEGA-UR STEERING CABLE	CAVO TIMONERIA MEGA-UR	CÂBLES DE DIRECTION MEGA-UR																																
<p>Reemplaza   Replace   Rimpiazzano   Remplace:                  Ultraflex T71FC, T72FC, T73NR FC, T81FC, T82FC, T83NR FC.                  Teleflex Safe-T QC, NFB 4.2, NFB Safe-T II</p>																																			
<table border="1"> <thead> <tr> <th>REF</th> <th></th> </tr> </thead> <tbody> <tr><td>PRE509007</td><td>7' / 2,14 m</td></tr> <tr><td>PRE509008</td><td>8' / 2,45 m</td></tr> <tr><td>PRE509009</td><td>9' / 2,75 m</td></tr> <tr><td>PRE509010</td><td>10' / 3,05 m</td></tr> <tr><td>PRE509011</td><td>11' / 3,35 m</td></tr> <tr><td>PRE509012</td><td>12' / 3,65 m</td></tr> <tr><td>PRE509013</td><td>13' / 3,95 m</td></tr> </tbody> </table>	REF		PRE509007	7' / 2,14 m	PRE509008	8' / 2,45 m	PRE509009	9' / 2,75 m	PRE509010	10' / 3,05 m	PRE509011	11' / 3,35 m	PRE509012	12' / 3,65 m	PRE509013	13' / 3,95 m	<table border="1"> <thead> <tr> <th>REF</th> <th></th> </tr> </thead> <tbody> <tr><td>PRE509014</td><td>14' / 4,25 m</td></tr> <tr><td>PRE509015</td><td>15' / 4,60 m</td></tr> <tr><td>PRE509016</td><td>16' / 4,90 m</td></tr> <tr><td>PRE509017</td><td>17' / 5,20 m</td></tr> <tr><td>PRE509018</td><td>18' / 5,50 m</td></tr> <tr><td>PRE509019</td><td>19' / 5,80 m</td></tr> <tr><td>PRE509020</td><td>20' / 6,10 m</td></tr> </tbody> </table>	REF		PRE509014	14' / 4,25 m	PRE509015	15' / 4,60 m	PRE509016	16' / 4,90 m	PRE509017	17' / 5,20 m	PRE509018	18' / 5,50 m	PRE509019	19' / 5,80 m	PRE509020	20' / 6,10 m		
REF																																			
PRE509007	7' / 2,14 m																																		
PRE509008	8' / 2,45 m																																		
PRE509009	9' / 2,75 m																																		
PRE509010	10' / 3,05 m																																		
PRE509011	11' / 3,35 m																																		
PRE509012	12' / 3,65 m																																		
PRE509013	13' / 3,95 m																																		
REF																																			
PRE509014	14' / 4,25 m																																		
PRE509015	15' / 4,60 m																																		
PRE509016	16' / 4,90 m																																		
PRE509017	17' / 5,20 m																																		
PRE509018	18' / 5,50 m																																		
PRE509019	19' / 5,80 m																																		
PRE509020	20' / 6,10 m																																		

ACCESORIOS DIRECCIÓN MECÁNICA	ACCESSORIES FOR STEERING SYSTEM	ACCESSORI PER TIMONERIA MECCANICA	ACCESSOIRES POUR DIRECTION MÉCANIQUE
REF			
PRE370618	Cardan de unión del cable de dirección al motor. Swivel joint for steering cables.	Per unire cavi timoneria al motore.	Union cardan du câble de direction au moteur.
PRE370046	Soporte para cable de dirección. Para montaje en el espejo de popa Bracket kit for inboard transom steering mount.	Supporto per cavi timoneria. Per il montaggio nello specchio di poppa.	Support pour câble de direction. Pour montage sur le tableau AR
PRE370613	Soporte para cable de dirección. Para montaje estanco en los laterales de la embarcación. Regulable. Bracket kit for inboard side splashwell steering mount.	Supporto per cavi timoneria. Montaggio della flangia ai lati dell'imbarcazione. Regolabile.	Support pour câble de direction. Pour un montage étanche sur les côtés du bateau. Réglable.
PRE370619	Rótula para unión rápida del cable de dirección al motor. Ball joint for steering cables.	Giunto per unire i cavi timoneria al motore.	Rotule pour une connexion rapide du câble de direction au moteur.
PRE370621	Barra de reenvío para conexión de los cables de dirección. Fabricada en acero inox. Reforzada. Link arm for outboards steering.	Barra di direzione per collegare i cavi. In acciaio inox. Rinforzata.	Barre de renvoi pour connecter les câbles de direction. Fabriqué en acier inoxydable. Renforcé



PRE370618



PRE370046



PRE370619



PRE370613



PRE370621

DIRECCIÓN HIDRÁULICA	HYDRAULICS STEERING SYSTEM	TIMONERIA IDRAULICA	DIRECTION HYDRAULIQUE
----------------------	----------------------------	---------------------	-----------------------

FUERABORDAS 150 HP	OUTBOARDS 150 HP	FUORIBORDO 150 HP	HORS-BORD 150 HP
--------------------	------------------	-------------------	------------------

Bomba de aluminio, con válvula antirretorno incorporada. Cilindro de aluminio y acero inox. con purgadores. Se suministra completa con racors, tubo flexible de rilsan y 2L de aceite hidráulico	Helm pump made in aluminum, with non-return valve incorporated. Cylinder in aluminum and stainless steel, with breather valves. Completed with racors, rilsan tubing and 2L hydraulic oil.	Corpo pompa in alluminio, con valvola anti-ritorno incorporata. Cilindro in alluminio e acciaio inox, con spurgo. Si vende completa di raccordi, tubo flessibile e 2 l di olio idraulico.	Pompe en aluminium, avec clapet anti-retour intégré. Vérin en aluminium et acier inoxydable. Livré complet avec raccords, tube flexible et 2L d'huile hydraulique
--------------------------------------------------------------------------------------------------------------------------------------------------------------------------------------------------	--------------------------------------------------------------------------------------------------------------------------------------------------------------------------------------------	-------------------------------------------------------------------------------------------------------------------------------------------------------------------------------------------	-------------------------------------------------------------------------------------------------------------------------------------------------------------------

				TX4200K 150 HP	TX6400K 300 HP
Modelo bomba	Pump model	Modelo pompa	Modèle de pompe	BayStar	SeaStar
Capacidad bomba	helm volume	Cap. Pompa	Capacité de la pompe	23 cm <sup>3</sup>	27,8 cm <sup>3</sup>
Modelo cilindro	Cylinder model	Mod. Cilindro	Modèle de vérin	HC4645H	HC5345H
Capacidad cilindro	Cylinder volume	Cap. Cilindro	Cylindrée	105 cm <sup>3</sup>	139 cm <sup>3</sup>
Carrera del pistón	Cylinder travel	Corsa pistone	Course du vérin	206 mm	206 mm
Nº vueltas babor-estribor	Turns lock to lock	Nº giri a destra e sinistra	No. tourne bâbord-tribord	5	5
Manguera con racors	Hose with racors	Tubo con raccordo	Tuyau avec raccords	2 x 6 m	2 x 7 m
Velocidad máxima	Max. speed	Velocità max	Vitesse maximale	50 kn	65 kn

**BayStar**  
TX4200K



**SeaStar**  
TX6400K





### TUBOS HIDRÁULICOS PARA TX6400K

### HYDRAULIC HOSES FOR TX6400K

### TUBI IDRAULICI PER TX6400K

### TUYAUX HYDRAULIQUES POUR TX6400K

2 Tubos con racors montados

Pair of hydraulic hoses with racors

2 tubi con raccordi montati

2 tuyaux avec raccords montés

REF		
TXMP5126	26' / 8 m	2

*Seastar*



### KITS

### KIT

### KITS

### KITS

Bomba de aluminio, con válvula anti-retorno y sobrepresión. Cilindro de aluminio y acero inoxidable, con purgadores. Se suministra completa con racors de latón cromado, tubo flexible de rilsan y aceite hidráulico.

Helm pump made in aluminum, with a non-return and pressure relief valves. Cylinder in aluminum and stainless steel, with breather valves. Completed with racors, rilsan tubing and hydraulic oil.

Corpo pompa in alluminio con valvola anti-ritorno e sovrappresione. Cilindro in alluminio e acciaio inox, con spurgo. Si vende completa di raccordi in ottone cromato, tubo flessibile e olio idraulico.

Pompe en aluminium, avec soupape de refoulement et de surpression. Vérin en aluminium et acier inoxydable. Livré complet avec raccords en laiton chromé, tuyau flexible et huile hydraulique.

				GS41062 80 hp	GS41065 150 hp	GS41066 300 hp	GS41059 350 hp
Modelo bomba	Pump model	Modello pompa	Modèle de pompe	GM3-MRA	GMO-MRA	GM2-MRA01	GM2-MRA01
Capacidad bomba	helm volume	Cap. Pompa	Capacité de la pompe	14 cm <sup>3</sup>	17 cm <sup>3</sup>	27 cm <sup>3</sup>	27 cm <sup>3</sup>
Modelo cilindro	Cylinder model	Mod. Cilindro	Modèle de vérin	MC90B	MC150BR	MC300A	MC350A
Capacidad cilindro	Cylinder volume	Cap. Cilindro	Cylindrée	75 cm <sup>3</sup>	83 cm <sup>3</sup>	130 cm <sup>3</sup>	140 cm <sup>3</sup>
Carrera del pistón	Cylinder travel	Corsa pistone	Course du vérin	206 mm	200 mm	198 mm	198 mm
Nº vueltas babor-estribor	Turns lock to lock	Nº giri destra e sinistra	No. tours bâbord-tribord	5,2	4,9	4,9	5,2
Manguera con racors	Hose with racors	Tubo con raccordo	Tuyau avec raccords	2 x 5 m	2 x 6 m	2 x 7 m	2 x 7,5 m
Ø Tubo	Tube Ø	Ø Tubo	Ø Tuyau	6,3 mm = 1/4"	6,3 mm = 1/4"	7,94 mm = 5/16"	7,94 mm = 5/16"



GS41062



GS41065



GS41066



GS41059



**KITS DIRECCIÓN HIDRAULICA PARA COLAS**    **HYDRAULIC STEERING FOR STERN-DRIVE KITS**    **KIT TIMONERIA IDRAULICA PER PIEDI**    **DIRECTION HYDRAULIQUE POUR EMBASE**

Bomba de aluminio estampado en caliente.  
Eje de acero inox AISI 316.  
Rotor a 7 pistones fabricado en acero.  
Cilindro de aluminio y acero inox.  
Se suministra completa con racors, 2 x 7,5 m tubo flexible de rilsan y 2 L de aceite hidráulico.

Helm pump made in aluminum with hot pressing processing (not casting).  
Shaft made of stainless steel AISI 316.  
7 pistons rotor made in steel.  
Cylinder in aluminum and stainless steel, with breather valves.  
Completed with racors, rilsan tubing and 2 L hydraulic oil.

Corpo pompa in alluminio con stampaggio a fusione.  
Asse in acciaio inox AISI316.  
Cilindro a 7 pistoni fabbricato in acciaio.  
Cilindro in alluminio e acciaio inox.  
Si vende completo di raccordi, 2x7,5 m di tubo flessibile e 2 l di olio idraulico.

Pompe en aluminium estampé à chaud.  
Arbre en acier inoxydable AISI 316.  
Rotor à 7 pistons en acier.  
Vérin en aluminium et acier inoxydable.  
Livré complet avec raccords, 2 tuyaux flexibles de 7,5 m et 2 litres d'huile hydraulique.

SERVO-ASISTIDA	POWER ASSISTED	SERVOASSISTITO	ASSISTÉE	GS41053
Denominación	Model	Modello	Dénomination	GF150ET
Modelo bomba	Pump model	Modello pompa	Modèle de pompe	GM2-MRA01
Capacidad bomba	helm volume	Cap. pompa	Capacité de la pompe	27 cm <sup>3</sup>
Modelo cilindro	Cylinder model	Mod. cilindro	Modèle de vérin	MC150
Capacidad cilindro	Cylinder volume	Cap. pompa	Cylindrée	88cm <sup>3</sup>
Carrera del pistón	Cylinder travel	Corsa pistone	Course du vérin	200 mm
Peso bomba	Helm weight	Peso pompa	Poids de la pompe	3 kg
Nº vueltas babor-estribor	Turns lock to lock	Nº giri destra e sinistra	No. tours bâbord-tribord	3,4
Ø Tubo	Tube Ø	Ø Tubo	Ø Tuyau	7,94 mm / 5/16"
Longitud tubo	Tube length	Lungh. tubo	Longueur tuyau	2 x 7,5 m



SIN SERVO	NON POWER ASSISTED	SERVOASSISTITO	ASSISTÉE	GS41054
Denominación	Model	Modello	Dénomination	GF300BET
Modelo bomba	Pump model	Modello pompa	Modèle de pompe	GM2-MRA03
Capacidad bomba	helm volume	Cap. pompa	Capacité de la pompe	32 cm <sup>3</sup>
Modelo cilindro	Cylinder model	Mod. cilindro	Modèle de vérin	MC300BET
Capacidad cilindro	Cylinder volume	Cap. cilindro	Cylindrée	146 cm <sup>3</sup>
Carrera del pistón	Cylinder travel	Corsa pistone	Course du vérin	200 mm
Peso bomba	Helm weight	Peso pompa	Poids de la pompe	3,7 kg
Nº vueltas babor-estribor	Turns lock to lock	Nº giri destra e sinistra	No. tours bâbord-tribord	4,6
Ø Tubo	Tube Ø	Ø Tubo	Ø Tuyau	7,94 mm / 5/16"
Longitud tubo	Tube length	Lungh. tubo	Longueur tuyau	2 x 7,5 m



**ACCESORIOS DIRECCIÓN HIDRAULICA**    **ACCESSORIES FOR HYDRAULIC STEERING SYSTEM**    **ACCESSORI PER TIMONERIA IDRAULICA**    **ACCESSOIRES POUR DIRECTION HYDRAULIQUE**

REF	R.O. OEM				(mm)	
GS41080		Barra de dirección para conexión de los cables de dirección. Acero inox.	Link arm for outboards steerings. Stainless steel.	Barra di rinvio per la connessione dei cavi timoneria. Fabbricata in acciaio inox.	Barre de renvoi pour connecter les câbles de direction. Acier inoxydable.	320 - 340
GS41082		Barra de dirección con conexión rápida para conexión de los cables de dirección. Acero inox.	Link arm quick connection for outboards steerings. Stainless steel.	Barra di rinvio con connessione rapida per la connessione dei cavi timoneria. Fabbricata in acciaio inox.	Barre de renvoi avec connexion rapide pour connecter les câbles de direction. Acier inoxydable.	330 - 370
GS41083		Barra de unión para el acople de dos motores	Universal tie bar for two engines	Barra di unione per accoppiamento di due motori.	Barre d'accouplement pour deux moteurs	850
GS41084	6E5-61301-01 6E5-61301-00	Barra de unión con conexión a rótula para el acople de dos motores fueraborda hasta 300 hp. Acero inox. Aisi 316.	Universal tie bar with spherical joint for two engines up to 300 hp. Made in stainless steel.	Barra di unione con snfo sferico per due motori fuoribordo fino a 300hp. In acciaio inox aisi316	Kit barre d'accouplement à rotule pour deux moteurs hors-bord jusqu'à 300 ch. Acier inoxydable. Aisi 316.	640 - 780



**BOMBA**    **PUMP**    **POMPA**    **POMPE**

REF	R.O. OEM
GS41070	GM3-MRA
GS41071	GM0-MRA
GS41072	GM2-MRA01
GS41073	GM2-MRA03



CILINDRO	CYLINDER	CILINDRO	VERIN										
<table border="1"> <thead> <tr> <th>REF</th> <th>R.O. OEM</th> </tr> </thead> <tbody> <tr> <td>GS41077</td> <td>MC350HD</td> </tr> <tr> <td>GS41060</td> <td>MC90B</td> </tr> <tr> <td>GS41063</td> <td>MC150BR</td> </tr> <tr> <td>GS41089</td> <td>MC300A</td> </tr> </tbody> </table>	REF	R.O. OEM	GS41077	MC350HD	GS41060	MC90B	GS41063	MC150BR	GS41089	MC300A			
REF	R.O. OEM												
GS41077	MC350HD												
GS41060	MC90B												
GS41063	MC150BR												
GS41089	MC300A												

CONECTORES	CONNECTORS	PIASTRA CONNESSIONE	CONNECTEURS												
<table border="1"> <thead> <tr> <th>REF</th> <th></th> <th></th> </tr> </thead> <tbody> <tr> <td>GS41067</td> <td>Honda 115-130</td> <td>1</td> </tr> <tr> <td>GS41068</td> <td>Yamaha 40-50-60-70 HP Honda 115-130 HP</td> <td>1</td> </tr> <tr> <td>GS41069</td> <td>Mercury Optimax 115 Mercury 150 EFI</td> <td>1</td> </tr> </tbody> </table>	REF			GS41067	Honda 115-130	1	GS41068	Yamaha 40-50-60-70 HP Honda 115-130 HP	1	GS41069	Mercury Optimax 115 Mercury 150 EFI	1			
REF															
GS41067	Honda 115-130	1													
GS41068	Yamaha 40-50-60-70 HP Honda 115-130 HP	1													
GS41069	Mercury Optimax 115 Mercury 150 EFI	1													
	GS41069	GS41067	GS41068												

ACEITE PARA DIRECCIÓN HIDRÁULICA	OIL FOR HYDRAULIC STEERING SYSTEM	OLIO PER TIMONERIA IDRAULICA	HUILE POUR DIRECTION HYDRAULIQUE				
<table border="1"> <thead> <tr> <th>REF</th> <th></th> </tr> </thead> <tbody> <tr> <td>GS41074</td> <td>1 L</td> </tr> </tbody> </table>	REF		GS41074	1 L			
REF							
GS41074	1 L						

MANDOS UNIVERSALES Y ACCESORIOS	UNIVERSAL CONTROLS AND ACCESSORIES	CONTROLLI UNIVERSALI E ACCESSORI	COMMANDES UNIVERSELLES ET ACCESSOIRES
---------------------------------	------------------------------------	----------------------------------	---------------------------------------

MANDO ELECTRÓNICO	ELECTRONIC CONTROL	SCATOLA DI COMANDO	COMMANDE ÉLECTRONIQUE
-------------------	--------------------	--------------------	-----------------------

Reemplaza y mejora el funcionamiento de los mandos mecánicos tradicionales, permitiendo un control más preciso y suave de las maniobras. Se suministran en kits completos con todos los componentes para sustituir de modo sencillo los mandos tradicionales, listos para instalar y operar. Sistema de conexión CANbus. Alimentación estandar 12V (24V Bajo demanda).

- Hasta 6 puestos de control.
- Sincronización de r.p.m. en ambos motores.
- Posibilidad de aumentar y reducir las revoluciones del motor mediante ligeras pulsaciones de los botones de control.
- Puede incorporar mandos de control remoto mediante conexión «CANbus».
- Memoria de diagnósticos de avisos y alarmas.

Easily upgrade the traditional boat mechanical controls. Gives finger tip, precise control of your engines shift and throttle functions. Supplied in complete kits with all components required and ready to install. Latest CANbus technology for easy installation and set up. 12V Standard power (24V on demand).

- Can be connected up to 6 control heads.
- Auto synchronization r.p.m.
- Possibility of throttle in «BUMP» mode.
- Can incorporate Handheld Remote Controls.
- Memory of diagnostics checks of warning and alarms.



Sostituisce e migliora la scatola di comando tradizionale, permettendo un controllo più preciso delle manovre. Si vende in kit completo con tutti i componenti richiesti per sostituire in modo semplice la scatola di comando tradizionale. Tecnologia CANbus, Alimentazione standard 12V (24V on demand).

- Fino a 6 postazioni di controllo
- Auto sincronizzazione r.p.m.
- Possibilità di diminuire e aumentare i giri del motore, tramite un pulsante di controllo.
- Si può incorporare comandi di controllo remoto tramite la connessione CANbus
  - Memoria diagnostica di avviso e allarme.

Elle remplace et améliore le fonctionnement des commandes mécaniques traditionnelles, permettant un contrôle plus précis et plus fluide des manœuvres. Ils sont fournis en kits complets avec tous les composants pour remplacer facilement les commandes traditionnelles, prêts à installer et à utiliser. Système de connexion CANbus. Alimentation standard 12V (24V sur demande).

- Jusqu'à 6 points de contrôle peuvent être connectés.
- Synchronisation de r.p.m. dans les deux moteurs.
- Possibilité d'augmenter et de réduire les tours du moteur en appuyant légèrement sur les boutons de commande.
- Vous pouvez intégrer des commandes de télécommande via une connexion «CANbus».
- Mémoire de diagnostic des avertissements et alarmes.

KITS	KITS	KIT	KITS	
<b>1 MOTOR INTERIOR 1 ESTACIÓN</b>	<b>1 INBOARD ENGINE 1 STATION</b>	<b>1 MOTORE ENTROBORDO 1 STAZIONE</b>	<b>1 MOTEUR IN-BORD 1 STATION</b>	<b>GLE1M1EI</b>
Actuador SA2	Actuator SA2	1 attuatore SA2	Actionneur SA2	1
Mando 1 palanca - 2 pulsadores	Single Control Head - 2-buttons	Telecomando 1 leva - 2 pulsanti	1 commande à levier - 2 boutons	1
Cable comunicación mando-actuador 12 m	Station comm. cable 40ft.	Cavo comunicazione comando-attuatore 12m	Câble de communication commande-actionneur 12 m	1
Resistencia terminal BUS	Terminating resistor	Resistenza terminale BUS	Résistance de borne BUS	2
Cable alimentación DC - actuador 9 m.	Harness DC power-actuador 30ft.	Cavo alimentazione DC- attuatore 9m	Câble d'alimentation CC - actionneur 9 m.	1
Cable Start Interlock 9 m	Harness Start Interlock 30ft	Cablaggio start e blocco 9m	Câble de verrouillage de démarrage 9 m	1
Cable encendido «jumper»	Harness Ignition enable jumper	Cablaggio accensione	Câble d'allumage de cavalier	1
Cable encendido 9 m	Harness Ignition 40ft.	Cablaggio accensione	Câble sur 9 m	1
<b>KIT 2ª ESTACIÓN 1 MOTOR INTERIOR</b>	<b>KIT 2ND STATION 1 ENGINE INBOARD</b>	<b>KIT 2ª STAZIONE 1 MOTORE ENTROBORDO</b>	<b>KIT DE 2E STATION 1 MOTEUR IN-BORD</b>	<b>GLE1M2EI</b>
Mando 1 palanca - 2 pulsadores	Single Control Head - 2-buttons	Telecomando- 1 leva- 2 pulsanti	1 commande à levier - 2 boutons	1
Cable comunicación mando-actuador 12 m	Station comm. cable 40ft.	Cavo cablaggio comando-attuatore 12m.	Câble de communication commande-actionneur 12 m	1

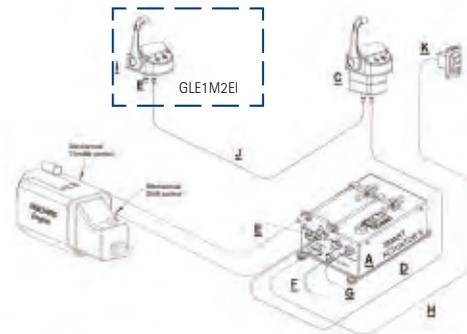

<b>2 MOTORES INTERIORES 1 ESTACIÓN</b>	<b>2 INBOARD ENGINES 1 STATION</b>	<b>2 MOTORI ENTROBORDO 1 STAZIONE</b>	<b>2 MOTEURS IN-BORD 1 STATION</b>	<b>GLE2M1EI</b>
Actuador SA2	Actuator SA2	Attuatore SA2	Actionneur SA2	2
Mando 2 palanca - 2 pulsadores	Twin Control Head - 2-buttons	Telecomando 2 leve- 2 pulsanti	2 commandes à levier - 2 boutons poussoirs	1
Cable comunicación mando-actuador 12 m	Station comm. cable 40ft.	Cavo cablaggio comando-attuatore 12m	Câble de communication commande-actionneur 12 m	1
Cable comunicación actuador-actuador 6 m	Station comm. cable 20ft.	Cavo cablaggio comando-attuatore 6m	Câble de communication actionneur-actionneur 6 m	1
Resistencia terminal BUS	Terminating resistor	Resistenza terminale BUS	Résistance de borne BUS	2
Cable alimentación DC - actuador 9 m.	Harness DC power-actuador 30ft.	Cavo alimentazione BUS-attuatore 9m	Câble d'alimentation CC - actionneur 9 m.	2
Cable Start Interlock 9 m	Harness Start Interlock 30ft	Cablaggio start e blocco 9m	Câble de verrouillage de démarrage 9 m	2
Cable encendido «jumper»	Harness Ignition enable jumper	Cablaggio accensione	Câble d'allumage de cavalier	1
Cable actuador sensor tacómetro	Harness Act. enable tach sender.	Cavo attuatore sensore tachimetro	Câble d'actionneur de capteur de tachymètre	1
Cable encendido 12 m	Harness Ignition 40ft.	Cavo accensione 12m	Câble sur 12 m	1
<b>KIT 2ª ESTACIÓN 2 MOTORES INTERIOR</b>	<b>KIT 2ND STATION 2 ENGINE INBOARD</b>	<b>KIT 2ª STAZIONE 2 MOTORI ENTROBORDO</b>	<b>KIT DE 2E STATION 2 MOTEURS IN-BORD</b>	<b>GLE2M2EI</b>
Mando 2 palanca - 2 pulsadores	Twin Control Head - 2-buttons	Telecomando 2 leve-2 pulsanti	2 commandes à levier - 2 boutons poussoirs	1
Cable comunicación mando-actuador 12 m	Station comm. cable 40ft.	Cavo cablaggio comando-attuatore 12m	Câble de communication commande-actionneur 12 m	1

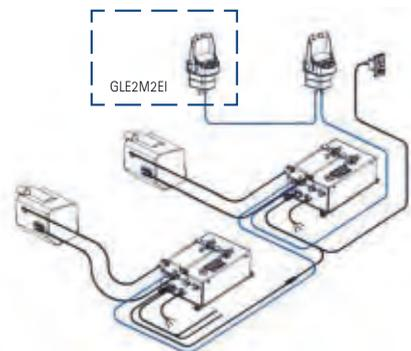

1 MOTOR INTRA/FUERABORDA O FUERABORDA 1 ESTACIÓN + TRIM	1 ENGINE I/O - OUTBOARD 1 STATION + TRIM	1 MOTORE ENTRO/FUORIBORDO O FUORIBORDO 1 STAZIONE + TRIM	1 MOTEUR IN-BORD OU HORS-BORD 1 STATION + GARNITURE	GLE1M1EC
Actuador SA2	Actuator SA2	Attuatore SA2	Actionneur SA2	1
Mando 1 palanca - 6 pulsadores	Single Control Head - 6-buttons	Telecomando 1 leva- 6 pulsanti	1 commande à levier - 6 boutons	1
Cable comunicación mando-actuador 12 m	Station comm. cable 40ft.	Cavo cablaggio comando-attuatore 12m	Câble de communication commande-actionneur 12 m	1
Resistencia terminal BUS	Terminating resistor	Resistenza terminale BUS	Résistance de borne BUS	2
Cable alimentación DC - actuador 9 m.	Harness DC power-actuator 30ft.	Cavo alimentazione DC- attuatore 9m	Câble d'alimentation CC - actionneur 9 m.	1
Cable Trim/Encendido/Start interlock	Harness Trim/Ignition/Start Interlock	Cavo trim/accensione/start e blocco	Câble de verrouillage Trim / On / Start	1

KIT 2ª ESTACIÓN 1 MOTOR INTRA/FUERABORDA O FUERABORDA 2 ESTACIONES + TRIM	KIT 2ND STATION 1 ENG. I/O - OUTBOARD 2 STATIONS + TRIM	KIT 2° STAZIONE 1 MOTORE ENTRO/FUORIBORDO O FUORIBORDO 2 STAZIONE + TRIM	KIT DE 2E STATION 1 MOTEUR IN-BORD OU HORS-BORD 2 STATIONS + GARNITURE	GLE1M2EC
Mando 1 palanca - 6 pulsadores	Single Control Head - 6-buttons	Telecomando 1 leva- 6 pulsanti	1 commande à levier - 6 boutons	1
Cable comunicación mando-actuador 12 m	Station comm. cable 40ft.	Cavo cablaggio comando-attuatore 12m	Câble de communication commande-actionneur 12 m	1

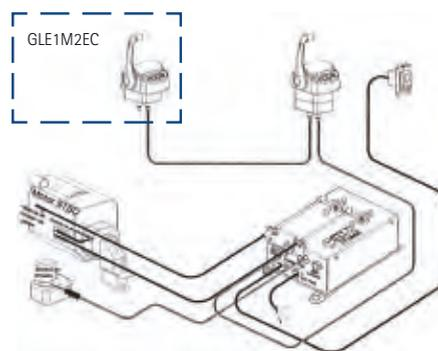

2 MOTORES INTRA/FUERABORDA O FUERABORDA 1 ESTACIÓN + TRIM	2 INBOARD ENGINES 1 STATION	1 MOTORE ENTRO/FUORIBORDO O FUORIBORDO 1 STAZIONE + TRIM	2 MOTEURS IN-BORD OU HORS-BORD 1 STATION + GARNITURE	GLE2M1EC
Actuador SA2	Actuator SA2	Attuatore SA2	Actionneur SA2	2
Mando 2 palancas - 6 pulsadores	Twin Control Head - 6-buttons	Telecomando 2 leve- 6 pulsanti	Contrôle 2 leviers - 6 boutons	1
Cable comunicación mando-actuador 12 m	Station comm. cable 40ft.	Cavo cablaggio comando-attuatore 12m	Câble de communication commande-actionneur 12 m	1
Cable comunicación actuador-actuador 6 m	Station comm. cable 20ft.	Cavo cablaggio comando- attuatore 6m	Câble de communication actionneur-actionneur 6 m	1
Resistencia terminal BUS	Terminating resistor	Resistenza terminale BUS	Résistance de borne BUS	2
Cable alimentación DC - actuador 9 m.	Harness DC power-actuator 30ft.	Cavo alimentazione DC- actuatore 9m	Câble d'alimentation CC - actionneur 9 m.	2
Cable Encendido/Tacómetro babor.	Harness Ignition/Tach sender port	Cavo accensione/ tachimetro sinistra	Tachymètre pour câble d'alimentation / port.	1
Cable Tacómetro esribor.	Harness Tach sender starboard.	Cavo tachimetro destra	Câble tachymètre tachymétrique.	1
Cables Trim / Start Interlock.	Harness Trim / Start Interlock.	Cavo trim/ start e blocco	Trim / Start Interlock cables.	2

KIT 2ª ESTACION 2 MOTORES INTRA/FUERABORDA O FUERABORDA 2 ESTACIONES + TRIM	KIT 2ND STATION 2 ENGINE I/O - OUTBOARD 2 STATIONS + TRIM	KIT 2° STAZIONE 2 MOTORE ENTRO/FUORIBORDO O FUORIBORDO 2 STAZIONE + TRIM	KIT DE 2E STATION 2 MOTEURS IN-BORD OU HORS-BORDRES 2 STATIONS + GARNITURE	GLE2M2EC
Mando 2 palanca - 6 pulsadores	Twin Control Head - 6-buttons	Telecomando 2 leve- 6 pulsanti	2 commandes à levier - 6 boutons	1
Cable comunicación mando-actuador 12 m	Station comm. cable 40ft.	Cavo cablaggio comando-attuatore 12m	Câble de communication commande-actionneur 12 m	1

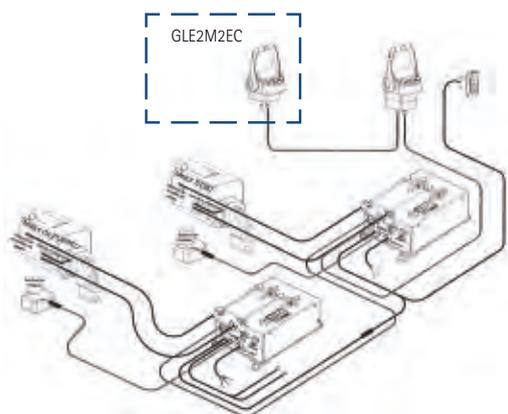

## SISTEMA DE GOBIERNO Y ACCESORIOS DE INSTALACIÓN

## STEERING SYSTEM & INSTALATION ACCESSORIES

## SISTEMA DI GUIDA E ACCESSORI DIREZIONE

## SYSTÈME DE DIRECTION ET ACCESSOIRES D'INSTALLATION

### MANGUERA DE PROTECCION

Manguera de protección para los cables de dirección, mando, etc. desde la salida del casco hasta el motor, presentando un sólo núcleo limpio y ordenado.  
Color gris.

### PROTECTIVE CABLE SYSTEM

This system gives a good protection to the service cables of outboard engines against dirt and corrosion. Available in two diameters, complete with fittings in black colour. Hose in grey colour.

### TUBO DI PROTEZIONE

Tubo di protezione per cavi di timoneria, comando etc. dall'uscita dello scafo fino al motore, per tenere i cavi ordinati. Colore grigio.

### GAINE DE PROTECTION

Gaine de protection pour les câbles de direction, de commande, etc. de la sortie de coque au moteur, présentant un seul fourreau propre et bien rangé. Gris.

REF			Ø INT (mm)		
GS41164	Kit	80 cm	50	1	
GS41165		80 cm	32	1	
GS41160	Terminal casco Hull end fitting		50	1	
GS41166	Terminale scafo Terminal coque		32	1	
GS41161	Manguera Hose	15 m	50		15 m
GS41167	Tube Gaine	15 m	32		15 m
GS41162	Terminal motor Engine end fitting		50	1	
GS41168	Terminale motore Terminal moteur		32	1	



### ARO PROTECTOR

Protección de los cables de control y dirección. Vinilo marino resistente a los rayos U.V., gasolina y aceites. Se ajusta alrededor de los cables.

### CABLE BOOTS

Finishes and protects pass thru hole for wires and cables. Rugged marine vinyl. Resists UV, gasoline and oil. Cable tie snugs around wires and cables.

### CUFFIA PASSACAVO

Protezione di cavi di controllo e di comando. Vinile marino resistente a raggi UV, benzina e oli. Si adatta attorno ai cavi.

### ANNEAU DE PROTECTION

Protection des câbles de commande et de direction. Vinyle marin résistant aux rayons UV, à l'essence et aux huiles. Il s'adapte autour des fils.

REF	PARA AGUJERO FOR HOLE PER FORI POUR TROU	
THCB-2	2"	1
THCB-1	3"	1
THCB-4	4 1/2"	1
THCB-2W	2"	1
THCB-1W	3"	1
THCB-4W	4 1/2"	1



Protección de los cables de control y dirección. Fabricado en plástico cromado.

Finishes and protects pass thru hole for wires and cables. Chrome plated plastic.

Protezione cavi di controllo e di comando. Fabbriato in plastica cromata.

Protection des câbles de commande et de direction. Fabriqué en plastique chromé.

REF	
THRF-1CP	1



### PROTECTOR ESPEJO

Fabricada en aluminio. Con soporte para terminal del cable de dirección.

### PROTECTION PLATE

Aluminum transom plate complete with support and tube for steering cable.

### PIASTRA SALVA POPPA

Fabbriata in alluminio. Con supporto per i cavi di timoneria.

### PLAQUE DE PROTECTION

Fabrique en aluminium Avec support pour de câble de direction.

REF		
GS73132	280 x 115 (mm)	1



Fabricada en plástico semirígido. Color blanco. Made in plastic. White. In plastica semirigida. Colore bianco. Fabriqué en plastique. Couleur blanche.

REF	(mm)	
GS73133	430 x 350	1



**GOLDENSHIP**

Fabricada en plástico semirígido. Made in plastic. In plastica semirigida. Fabriqué en plastique.

REF	(mm)	
GS73130	225 x 85	1
GS73131	270 x 100	1



**GOLDENSHIP**

Fabricada en polipropileno resistente a los rayos UV. Color blanco. Made in solid UV resistant polypropilene. Colour white. Fabbricata in polipropileno resistente ai raggi UV. Colore bianco. Fabriqué en polypropylène résistant aux UV. Couleur blanche.

REF	A (mm)	B (mm)	C (mm)	GRUESO THICKNESS SPESSORE EPAISSEUR (mm)	
OCE100133	390	350	330	8	1
OCE100134	390	350	330	15	1



**OCEANSOUTH**

**CONTRAPLACA TRANSOM**    **TRANSOM SUPPORT PLATE**    **CONTROPIASTRA**    **CONTRE-PLAQUE**

Reparte el esfuerzo de los tornillos de sujeción del motor. Fabricado en aluminio de alta calidad, de 10mm de espesor. Distributes stress of engine bolts. Manufactured in high quality cast aluminum. All plates 3/8". Contropiastra. Fabbricata in alluminio di alta qualità, di 10mm di spessore. Répartissez l'effort des boulons de fixation du moteur. Fabriqué en aluminium de haute qualité, épaisseur 10 mm.

REF		A	B	C
THTSP-1	Para tornillos superiores For top bolts Per viti superiori Pour vis supérieures	15"	2"	13"
THTSP-2	Para tornillos inferiores For lower bolts Per viti inferiori Pour vis inférieures	12"	2"	10"



**MARINE**

**TUERCA DE ENGRASE**    **STEERING GUARD**    **DADO LUBRIFICANTE**    **ÉCROU DE GRAISSAGE**

Tuerca engrasadora para todos los cables de dirección. Sella el cable evitando el agua y la corrosión. Steering guard to be installed in all cable and side mounted hydraulic steering systems to lubricate clean and seal the systems. Made of stainless steel. Dado lubrificante per tutti i cavi di timoneria. Chiude il cavo evitando l'acqua e la corrosione. Écrou de graissage pour tous les câbles de direction. Scellez le câble en évitant l'eau et la corrosion.

REF		
GS41170	7/8"	1



**GOLDENSHIP**

MANDO MECÁNICO

MECHANICAL CONTROL

SCATOLA MECCANICHE

CONTRÔLE MÉCANIQUE

TELEFLEX «XTREME»



new

Cambios mínimos en el esquema de montaje o anidamiento de cables desde Osprey o SL-3.  
Impulsiones de popa e interiores. La palanca de doble función controla el acelerador y el cambio de un motor. Enclavamiento neutro y protección de arranque en marcha (estándar) para controles de montaje lateral. TRIM/TILT opcional en el mango. Función de calentamiento del motor neutro (estándar). Interruptor de apagado de emergencia del motor para controles de montaje lateral. Acepta todos los tipos de cable OEM y 3300 / 33C. Cumple / excede todos los estándares aplicables.

Minimal changes to mounting scheme or cable nesting from Osprey or SL-3. Dual function lever controls both throttle and shift of one engine. Neutral interlock and start-in-gear protection (standard) for side mount controls. Optional TRIM / TILT in the handle. Neutral engine warm-up feature (standard). Standard lanyard-style cut-off switch for emergency engine shut down for side mount controls. Accepts every type of OEM and 3300/33C type cable. Meets/exceeds all applicable standards.

Modifiche minime dello schema di assemblaggio o di nidificazione dei cavi da Osprey o SL-3. Azionamenti di popa e interni. La leva a doppia funzione controlla l'acceleratore e il cambio di un motore. Interblocco neutro e protezione marcia in marcia (standard) per comandi di montaggio laterali. TRIM / TILT opzionale sul manico. Funzione di riscaldamento del motore neutro (standard). Interruttore di arresto di emergenza del motore per comandi di montaggio laterali. Accetta tutti i tipi di cavi OEM e 3300 / 33C. Soddisfa / supera tutti gli standard applicabili.

Modifications minimes dans le schéma d'assemblage des câbles d'Osprey ou SL-3. Commandes latérales ou sur console. Le levier à double fonction contrôle l'accélérateur et l'inversion de marche. Verrouillage neutre et protection de démarrage (standard) pour les commandes à montage latéral. TRIM / TILT en option sur la poignée. Fonction de chauffage neutre du moteur (standard). Interrupteur d'arrêt d'urgence du moteur pour commandes à montage latéral. Accepte tous les types de câbles OEM et 3300 / 33C. Répond / dépasse toutes les normes applicables.

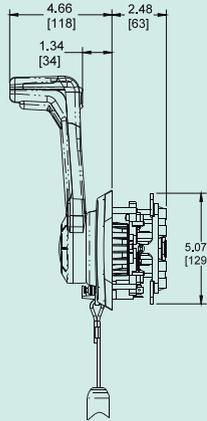

REF	LATERAL CENTRAL NEGRO	SIDE CENTER BLACK	LATERALE CENTRALE NERO	LATERAL NOIR
TXCH8850P	Interlock Hombre al agua	Interlock Stoper, hang rope assy	Interlock Stacco aut. d'emergencia	Verrouillage Coupe circuit
TXCH8852P	Interlock Hombre al agua Trim/Tilt	Interlock Stoper, hang rope assy Trim/Tilt switch	Interlock Stacco aut. d'emergencia Trim/Tilt switch	Verrouillage Coupe circuit Trim / Tilt

REF	LATERAL NEGRO	SIDE BLACK	LATERALE NERO	LATERAL NOIR
TXCH8550P	Interlock Hombre al agua	Interlock Stoper, hang rope assy	Interlock Stacco aut. d'emergencia	Verrouillage Coupe circuit
TXCH8552P	Interlock Hombre al agua Trim/Tilt	Interlock Trim/Tilt switch Stoper, hang rope assy	Interlock Trim/Tilt switch Stacco aut. d'emergencia	Verrouillage Coupe circuit Trim/Tilt
TXCH8553P	Interlock	Interlock	Interlock	Verrouillage
TXCH8555P	Interlock Trim/Tilt	Interlock Trim/Tilt switch	Interlock Trim/Tilt switch	Verrouillage Trim/Tilt

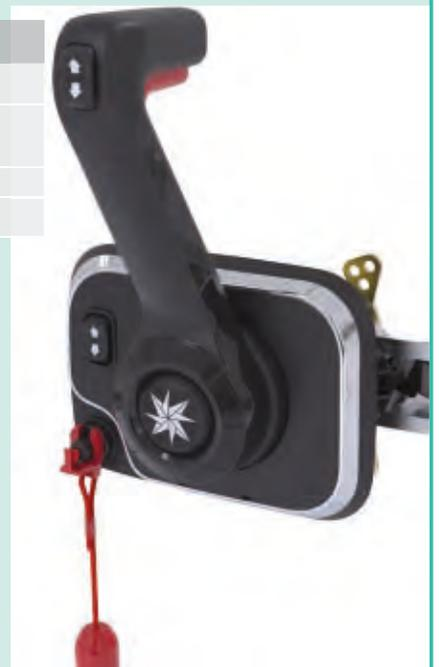
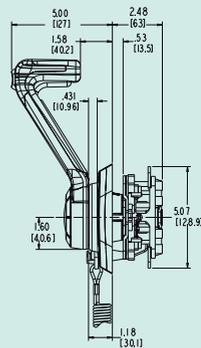
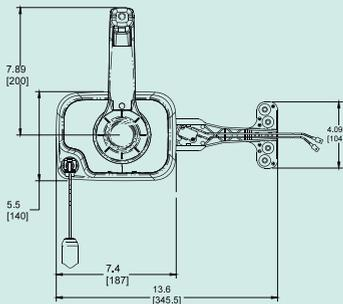



REF	CONSOLA NEGRO	CONSOLE BLACK	CONSOLLE NERO	CONSOLE NOIR
TXCHX8640P	Estándar	Standard	Standard	Standard
TXCHX8642P	Trim/Tilt	Trim/Tilt switch	Trim/Tilt switch	Trim/Tilt

REF	CONSOLA CROMADO	CONSOLE CHROME	CONSOLLE CROMATO	CONSOLE CHROME
TXCHX8650P	Interlock	Interlock	Interlock	Verrouillage
TXCHX8652P	Interlock Trim/Tilt	Interlock Trim/Tilt switch	Interlock Trim/Tilt switch	Trim/Tilt

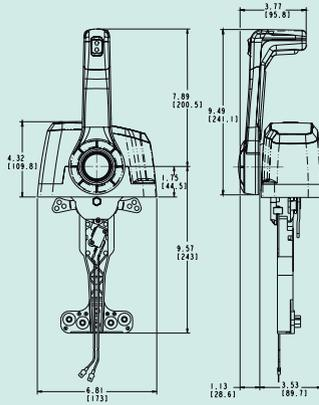

new

REF	CONSOLA DOBLE NEGRO	DOUBLE CONSOLE BLACK	CONSOLLE DOPPIO NERO	DOUBLE CONSOLE NOIR
TXCHX8740P	Estándar	Standard	Standard	Standard
TXCHX8742P	Trim/Tilt	Trim/Tilt switch	Trim/Tilt switch	Trim/Tilt

REF	CONSOLA DOBLE CROMADO	DOUBLE CONSOLE CHROME	CONSOLLE DOPPIO CROMATO	DOUBLE CONSOLE CHROME
TXCHX8240P	Estándar	Standard	Standard	Standard
TXCHX8242P	Trim/Tilt	Trim/Tilt switch	Trim/Tilt switch	Trim/Tilt

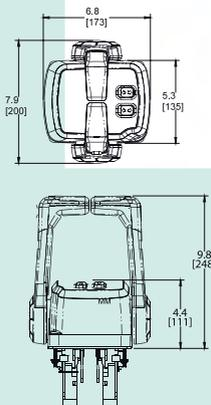
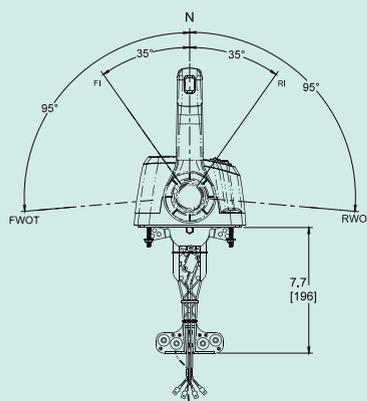

SOLUCIONES DE INSTALACIÓN • INTALATION SOLUTIONS • SOLUZIONI INSTALLAZIONE • SOLUTIONS D'INSTALLATIONS

**MANDO LATERAL SIDE CONTROL MANETTA LATERALE COMMANDE LATÉRALE**

Doble función (acelerador y cambio).  
Montaje lateral empotrado.  
Apropiado para embarcaciones a vela.  
Botón aceleración en punto muerto. Protección de arranque en punto muerto.  
**Utiliza 2 cables 33-C y 3300C.**

Single Lever Dual action side mount control designed for sail boats. Single lever throttle/gear control.  
Neutral safety switch option (prevents starting in gear).  
**Uses 33-C and 3300C cables.**

Doppia funzione (acceleratore e cambio).  
Montaggio laterale ad incasso. Ideale per imbarcazioni a vela.  
Pulsante acceleratore nel folle. Protezione di accensione nel folle.  
**Utilizza 2 cavi 33C e 3300C.**

Double fonction (accélérateur et inverseur).  
Montage latéral encastré. Convient aux voiliers.  
Bouton d'accélération au point mort. Protection démarrage au point mort.  
**Il utilise 2 câbles 33-C et 3300C.**



REF  
TX172103



Fabricado en plástico Hostafon y palancas de aluminio anodizado, independientes para acelerador y cambio.  
Con kit de adaptadores para cables 33C y 3300S, OMC, Mercury, Mariner y Suzuki.

Manufactured in Hostafon with levers in light alloy aluminum. Can be installed in both sides. With adaptors for 33C & 3300S, OMC, Mercury, Mariner and Suzuki.

Fabbricato in plastica. Manette in alluminio anodizzato, indipendenti per acceleratore e cambio.  
Con kit di adattatori per cavi 33C e 3300S, OMC, Mercury, Mariner e Suzuki

Fabriqu  en plastique et leviers en aluminium anodis , ind pendants pour l'acc l rateur et l'inverseur.  
Avec kit adaptateur pour câbles 33C et 3300S, OMC, Mercury, Mariner et Suzuki.

REF  
GS40001 114 x 228 mm



Palanca con doble función (acelerador y cambio).  
Para motores intraborda e intra-fueraborda.  
Montaje lateral superpuesto.  
**Utiliza cables 33-C y 3300S**

Dual function, single lever control.  
For virtually all stern drive, outboard and inboard engines.  
Push button for neutral engine warm-up.  
**For 33-C & 3300S cables**

Leva con doppia funzione (acceleratore e cambio).  
Per motori entro-bordo e entro-fuoribordo.  
Montaggio laterale.  
**Utilizza cavi 33-C e 3300S.**

Levier   double fonction (acc l rateur et inverseur).  
Pour moteurs in-bord et hors-bord.  
Montage lat ral.  
**Utilise des câbles 33-C et 3300S**

REF  
GS40015 YMD-RCBOX-00-10 (6C-50H)

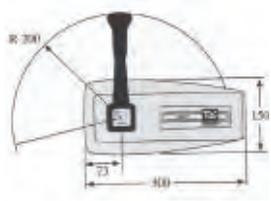

**MANDO CONSOLA CONSOLE CONTROL MANETTA CONSOLLE BOITIER DE CONSOLE**

Palanca de función única. (1 acelerador + 1 inversor).  
Para trabajos pesados.  
Con freno en la palanca de acelerador.  
Carcasa y palancas cromada de fundición.  
Con interruptor de protección de arranque en punto muerto.  
**Utiliza cables 33-C y 3300C**

Chrome plated heavy duty single function control for clutch and throttle.  
With twisting brake on throttle handle.  
**Uses 33-C and 3300C cables.**

Leva con unica funzione (1 acceleratore + 1 invertitore).  
Corpo e leve in acciaio cromato.  
Con interruttore di protezione di partenza nel folle.  
**Utilizza cavi 33C e 3300C.**

Levier   fonction unique. (1 acc l rateur + 1 inverseur).  
Pour les travaux lourds.  
Avec frein sur le levier d'acc l rateur.  
Leviers en fonte et fonte chrom e.  
Interrupteur de d marrage au point mort.  
**Utilise des câbles 33-C et 3300C**

REF  
PRE36468

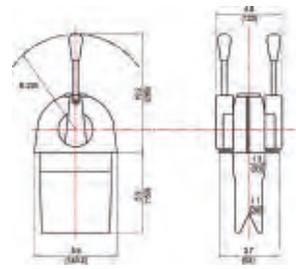

Palanca con doble función (acelerador y cambio). Para 1 ó 2 motores. Carcasa cromada de fundición. Interruptor de protección de arranque en punto muerto. Aceleración en punto muerto por desplazamiento exterior de la palanca. Utiliza 2 ó 4 cables 33-C y 3300C.

Chrome plated control for dual function by lever (clutch and throttle). Handle pulls out to operate neutral throttle. Neutral safety switch to ensure engine only starts when in neutral. Uses 33-C y 3300C cables.

Leve con doppia funzione (acceleratore e cambio). Per 1 o 2 motori. Struttura cromata. Interruttore di protezione di accensione nel Folle. Acceleratore nel Folle per il distanziamento esterno dalla leva. Utilizza 2 o 4 cavi 33-C e 3300C

Levier à double fonction (accélérateur et inverseur). Pour 1 ou 2 moteurs. Boîtier en fonte chromée. Interrupteur de démarrage au point mort. Accélération au point mort entrant le levier vers l'extérieur. Utilisez 2 ou 4 câbles 33-C et 3300C.



REF	PALANCA HANDLE LEVA LEVIER	MOTOR ENGINE MOTORI MOTEURS
PRE308601	1	1
PRE308602	2	2

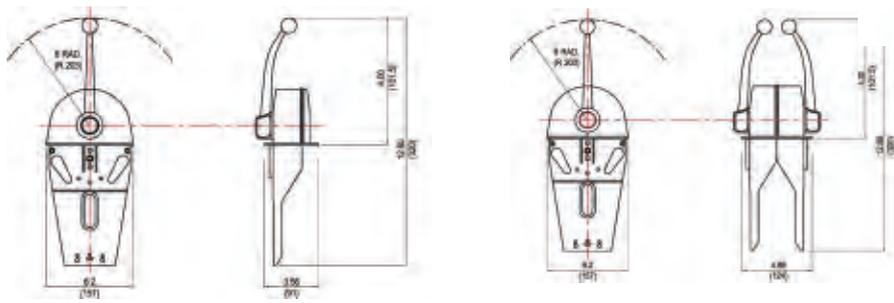

**DIFERENCIAL DOBLE PUENTE**

Utiliza cables 33-C y 3300S. Conecta los cables de dos mandos de modo que el motor pueda ser accionado independientemente desde los dos mandos.

**DUAL STATION TRANSFER UNIT**

Uses cables type 33-C & 3300S. Connects the cables of two stations to one engine. 1 unit for throttle, 1 unit for clutch.

**DIFFERENZIALE DOPPIA STAZIONE**

Utilizza cavi 33C e 3300S. Connette i cavi di due comandi in modo che il motore si possa azionare indipendentemente dalle manette.

**DIFFÉRENTIEL DOUBLE**

Utilise des câbles 33-C et 3300S. Connecte deux câbles de commande pour que le moteur puisse fonctionner indépendamment des deux commandes.

REF
GS40010

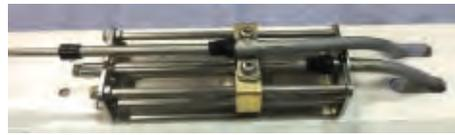

**CABLES DE MANDO CONTROL CABLES**

**CAVI COMANDO**

**CÂBLES DE COMMANDE**

**3300S**

Con doble funda para mejor eficiencia de trabajo. Recorrido trabajo: 76 mm. Rosca 10-32"

Double coating for maximum efficiency. Travel 3". Threaded 10-32"

Con doppia guaina per una miglior efficienza di lavoro. Estensione: 76 mm. Filetto 10.32"

Avec une double gaine pour une meilleure efficacité. Course: 76 mm. Fil 10-32"

REF	
PRE6300S05	5' / 1,50 m
PRE6300S06	6' / 1,80 m
PRE6300S07	7' / 2,10 m
PRE6300S08	8' / 2,45 m
PRE6300S09	9' / 2,75 m
PRE6300S10	10' / 3,05 m
PRE6300S11	11' / 3,35 m
PRE6300S12	12' / 3,65 m
PRE6300S13	13' / 3,95 m
PRE6300S14	14' / 4,25 m
PRE6300S15	15' / 4,60 m
PRE6300S16	16' / 4,90 m
PRE6300S17	17' / 5,20 m
PRE6300S18	18' / 5,50 m
PRE6300S19	19' / 5,80 m
PRE6300S20	20' / 6,10 m
PRE6300S21	21' / 6,40 m

REF	
PRE6300S22	22' / 6,70 m
PRE6300S23	23' / 7,00 m
PRE6300S24	24' / 7,30 m
PRE6300S25	25' / 7,60 m
PRE6300S26	26' / 7,90 m
PRE6300S27	27' / 8,25 m
PRE6300S28	28' / 8,55 m
PRE6300S29	29' / 8,85 m
PRE6300S30	30' / 9,15 m
PRE6300S31	31' / 9,50 m
PRE6300S32	32' / 9,75 m
PRE6300S33	33' / 10,00 m
PRE6300S34	34' / 10,35 m
PRE6300S35	35' / 10,65 m
PRE6300S36	36' / 11,00 m
PRE6300S38	38' / 11,50 m
PRE6300S40	40' / 12,10 m

REF	
PRE6300S42	42' / 12,70 m
PRE6300S44	44' / 13,30 m
PRE6300S46	46' / 14,00 m
PRE6300S48	48' / 14,50 m
PRE6300S50	50' / 15,00 m

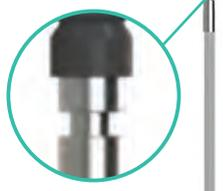

### 3300C

Recorrido trabajo: 76 mm.  
Rosca 10-32"

Travel 3"  
Threaded 10-32"

Estensione: 76 mm  
Filetto 10-32"

Course: 76 mm.  
Fil 10-32"

REF	RO	
PRE3300C05	YMM-21005-C8-00	5' / 1,50 m
PRE3300C06	YMM-21006-C8-00	6' / 1,80 m
PRE3300C07	YMM-21007-C8-00	7' / 2,10 m
PRE3300C08	YMM-21008-C8-00	8' / 2,45 m
PRE3300C09	YMM-21009-C8-00	9' / 2,75 m
PRE3300C10	YMM-21010-C8-00	10' / 3,05 m
PRE3300C11	YMM-21011-C8-00	11' / 3,35 m
PRE3300C12	YMM-21012-C8-00	12' / 3,65 m
PRE3300C13	YMM-21013-C8-00	13' / 3,95 m
PRE3300C14	YMM-21014-C8-00	14' / 4,25 m
PRE3300C15	YMM-21015-C8-00	15' / 4,60 m
PRE3300C16	YMM-21016-C8-00	16' / 4,90 m
PRE3300C17	YMM-21017-C8-00	17' / 5,20 m
PRE3300C18	YMM-21018-C8-00	18' / 5,50 m
PRE3300C19	YMM-21019-C8-00	19' / 5,80 m
PRE3300C20	YMM-21020-C8-00	20' / 6,10 m
PRE3300C21	YMM-21021-C8-00	21' / 6,40 m
PRE3300C22	YMM-21022-C8-00	22' / 6,70 m
PRE3300C23	YMM-21023-C8-00	23' / 7,00 m
PRE3300C24	YMM-21024-C8-00	24' / 7,30 m

REF	RO	
PRE3300C25	YMM-21025-C8-00	25' / 7,60 m
PRE3300C26	YMM-21026-C8-00	26' / 7,90 m
PRE3300C27	YMM-21027-C8-00	27' / 8,25 m
PRE3300C28	YMM-21028-C8-00	28' / 8,55 m
PRE3300C29	YMM-21029-C8-00	29' / 8,85 m
PRE3300C30	YMM-21030-C8-00	30' / 9,15 m
PRE3300C31		31' / 9,50 m
PRE3300C32		32' / 9,75 m
PRE3300C33		33' / 10,00 m
PRE3300C34		34' / 10,35 m
PRE3300C35		35' / 10,65 m
PRE3300C36		36' / 11,00 m
PRE3300C38		38' / 11,50 m
PRE3300C40		40' / 12,10 m
PRE3300C42		42' / 12,70 m
PRE3300C44		44' / 13,30 m
PRE3300C46		46' / 14,00 m
PRE3300C48		48' / 14,50 m
PRE3300C50		50' / 15,00 m

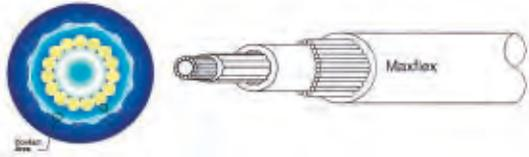

maxflex



### 4300C

Para trabajos pesados.  
Recorrido trabajo: 76 mm.  
Rosca 1/4-28"

Heavy Duty.  
Travel 3"  
Threaded 1/4-28"

Per lavori pesanti  
Estensione 7,6cm  
Filetto 1/4-28"

Pour les travaux lourds.  
Course: 76 mm.  
Filetage 1/4-28"

REF	
PRE6500C05	5' / 1,50 m
PRE6500C06	6' / 1,80 m
PRE6500C07	7' / 2,10 m
PRE6500C08	8' / 2,45 m
PRE6500C09	9' / 2,75 m
PRE6500C10	10' / 3,05 m
PRE6500C12	12' / 3,65 m
PRE6500C14	14' / 4,25 m
PRE6500C16	16' / 4,90 m
PRE6500C18	18' / 5,50 m
PRE6500C19	19' / 5,80 m
PRE6500C21	21' / 6,40 m
PRE6500C23	23' / 7,00 m

REF	
PRE6500C25	25' / 7,60 m
PRE6500C27	27' / 8,25 m
PRE6500C29	29' / 8,85 m
PRE6500C31	31' / 9,50 m
PRE6500C33	33' / 10,00 m
PRE6500C35	35' / 10,65 m
PRE6500C37	37' / 11,28 m
PRE6500C39	39' / 11,89 m
PRE6500C41	41' / 12,56 m
PRE6500C43	43' / 13,11 m
PRE6500C45	45' / 13,71 m
PRE6500C47	47' / 14,33 m



maxflex

PINNACLE

### CABLES DE STOP

### UTILITY CABLE

### CAVO DI STOP

### TIRETTES D'ARRÊT

REF	
PRE31507	7' / 2,10 m
PRE31508	8' / 2,45 m
PRE31509	9' / 2,75 m
PRE31510	10' / 3,05 m
PRE31511	11' / 3,35 m

REF	
PRE31512	12' / 3,65 m
PRE31513	13' / 3,95 m
PRE31514	14' / 4,25 m
PRE31515	15' / 4,60 m
PRE31516	16' / 4,90 m



maxflex

**ACCESORIOS PARA CABLES DE MANDO**

**ACCESSORIES FOR CONTROL CABLES**

**ACCESSORI CAVI COMANDI**

**ACCESSOIRES POUR CÂBLES DE COMMANDE**

REF					
PRE331125	Horquilla	Fork	Forcella	Chappe	1
PRE31799	Rótula	Ball joint	Snodo	Rotule	1
PRE308650	Pivote	Pivot	Perno	Pivot	1
PRE332010	Abrazadera	Clamp	Ferma cavo	Collier	1
PRE331538	Platina	Shim	Piastrina	Platine	1
PRE331980	Terminal ojo	Terminale eye	Terminale cavo	Terminal	1
PRE336174	Fijador 1 cable	Stop collar 1	Fissatore 1 cavo	Fixateur de câble	1
PRE215154	Fijador 2 cable	Stop collar 2	Fissatore 2 cavi	Fixateur 2 câbles	1
PRE31916	Tirador SD para cable de paro y otros usos	SD control. Handle for throttle, choke, stop, etc.	Tirante SD	Poignée SD pour câble d'arrêt et autres utilisations	1
PRE31917	Soporte angular para tirador SD	Mounting bracket for SD control	Supporto per tirante SD	Support angulaire pour SD shooter	1



**SISTEMA DE COMBUSTIBLE**

**FUEL SYSTEM**

**SISTEMA DI COMBUSTIBILE**

**SYSTÈME DE CARBURANT**

**CONECTOR TANQUE DE COMBUSTIBLE**

**TANK CONNECTOR**

**ATTACCO PER SERBATOIO**

**CONNECTEUR POUR RÉSERVOIR DE CARBURANT**

REF	R.O. OEM		
GS31025	MERCURY/MARINER	1/4" NPT	1
GS31073	YAMAHA		1
GS31083	772681 JOHNSON/EVINRUDE		1
GS31081	MERCURY/MARINER		1

REF	R.O. OEM		
GS31022	MERCURY/MARINER STANDAR		1
GS31023	MERCURY/MARINER NEW		1
GS31020	YAMAHA	1/4" NPT	1
GS31021	JOHNSON/EVINRUDE	1/4" NPT	1



**CONECTOR DOBLE**

**DOUBLE CONNECTOR**

**CONNETTORE DOPPIO**

**DOUBLE CONNECTEUR**

REF			
GS31091	OMC	8 mm	1
GS31092	YAMAHA	8 mm	1
GS31093	MERCURY/MARINER	8 mm	1



SOLUCIONES DE INSTALACIÓN • INTALATION SOLUTIONS • SOLUZIONI INSTALLAZIONE • SOLUTIONS D'INSTALLATIONS

**CODO DEPÓSITO DE LATÓN**      **TANK ELBOW IN BRASS**      **GOMITO SERBATOIO**      **COUDE EN LAITON**

REF		
GS31068	1/4" NPT	1

**GOLDENSHIP**  
MADE IN THE USA



**CONECTOR T**      **T CONNECTOR**      **CONNETTORE "T"**      **CONNECTEUR T**

Para conectar dos motores a un sólo depósito, o viceversa.

Fabricado en latón.  
Made in machined brass.

Per collegare due motori a un singolo serbatoio o viceversa.

Pour connecter deux moteurs à un seul réservoir, ou vice versa.

REF		
GS31069	1/4" NPT	1

**GOLDENSHIP**  
MADE IN THE USA



**PASAMAMPAROS**      **THRU HULL**      **PASSA SCAFO**      **PASSE CLOISONS**

Para atravesar mamparos de hasta 12 mm.  
Fabricado en latón.

For bulkhead up to 12 mm.  
Made in machined brass.

Per attraversare paratie fino a 12 mm.  
Fabricato in ottone.

Pour traverser des cloisons jusqu'à 12 mm.  
En laiton.

REF		
GS31064	3/8"	1

**GOLDENSHIP**  
MADE IN THE USA



**VÁLVULA ANTIRETORNO**      **NON-RETURN VALVE**      **VALVOLA ANTI-RITORNO**      **CLAPET ANTI-RETOUR**

Válvula antiretorno para líneas de combustible y ventilación.

In-Line non-return valve for fuel pipes.

Valvola anti-ritorno per linee di combustibile e ventilazione.

Clapet anti-retour pour les conduites de carburant et de ventilation.

REF		
GS31003	8 mm	1
GS31004	10 mm	1
GS31005	12 mm	1



**GOLDENSHIP**

**VÁLVULA DE COMBUSTIBLE**      **FUEL VALVE**      **VALVOLA CARBURANTE**      **VANNE POUR CARBURANT**

Válvula manual a 3 vías, para combustible. Fabricada en latón pulido. Montaje mediante soporte con 2 agujeros. Para conectar 2 depósitos a un solo motor.

Three ways fuel valve. Made in brass, with 2 holes flange. To connect 2 tanks to one single feeding pipe.

Valvola manuale a 3 uscite, per carburante. Fabricata in ottone. Fissare mediante supporto con 2 fori. Per collegare 2 serbatoi a un solo motore.

Vanne manuelle 3 voies, pour carburant. Fabriqué en laiton poli. Montage par support à 2 trous pour connecter 2 réservoirs à un seul moteur.

REF			
GS31010	1/4"	10 mm	1
GS31011	3/8"	10-13 mm	1



REF			
GS30111	1/4"	10 mm	1
GS30112	3/8"	12 mm	1



**GOLDENSHIP**

Válvula manual a 2 vías, para combustible. Fabricada en latón pulido.

Two ways fuel valve. Made in brass.

Valvola manuale a 2 uscite, per carburante. Fabricata in ottone.

Vanne manuelle 2 voies, pour carburant. Fabriqué en laiton poli.

REF			
GS31006	1/4" NPT	1/4" NPT	1



**GOLDENSHIP**

Válvula manual para combustible.  
Fabricada en latón cromado con racors.  
Puede montarse en línea o  
desmontando el soporte, incorporarla  
directamente al depósito.

Manual and remote fuel valve. Made in  
chrome plated brass.  
Can be mounted in line with hose or  
directly on gasoline tanks.

Valvola manuale per carburante.  
Fabricata in ottone cromato con  
raccordo. Si può montare in linea o  
smontando il supporto, incorporarla  
direttamente al serbatoio.

Vanne manuelle pour le carburant.  
Fabriqué en laiton chromé avec  
raccords.  
Elle peut être montée en ligne ou  
en l'intégrant directement dans le  
réservoir sans son support.

REF			
GS31012	1/4"	10 mm	1



### ELECTROVÁVULA DE COMBUSTIBLE

### FUEL ELECTRO-VALVE

### ELETTRORVALVOLA CARBURANTE

### ÉLECTROVANNE POUR CARBURANT

Incluye conexiones para mangueras  
flexibles y para tubo de cobre.  
Accionamiento a 12V y manual.  
CE 94/25 (EN28846) y R.I.Na.DIP  
61697

Fuel cut off electrovalve 12V with  
manual cock. Includes racors for  
flexible hose and cooper tube.  
CE 94/25 (EN28846) et R.I.Na.DIP  
61697

Incluye raccordi per tubo flessibile e per  
tubi di rame.  
Avviamento a 12V e manuale.  
CE 94/25 (EN28846) e R.I.Na.DIP  
61697

Comprend des connexions pour  
tuyaux flexibles et tube en cuivre.  
Entraînement 12V et manuel.  
CE 94/25 (EN28846) et R.I.Na.DIP  
61697

REF					
GS31013	12V	100l/h	1/4"	8-10 mm	1



### FILTROS DE COMBUSTIBLE

### FUEL FILTERS

### FILTRO BENZINA

### FILTRES À CARBURANT

#### FILTRO PARA MONTAJE EN LINEA

#### IN-LINE FILTER

#### FILTRO PER MONTARE IN LINEA

#### FILTRE POUR MONTAGE EN LIGNE

REF		
GS31185	6-8 mm	1
GS31186	6-8 mm	1



GS31185



GS31186

REF		
REC35-80365M	6 mm	2-8 HP (2 T/ Strokes) 8-15 HP (4 T/ Strokes)



REF			
GS31001	50 l/h	6-8 mm	1
GS31002	150 l/h	8-10 mm	1

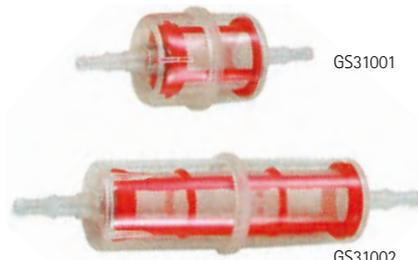

GS31001

GS31002

REF	R.O. OEM		
PAF4-05000300	35-16248	6 mm	4-9.8 HP (2 T/ Strokes) 4-25 HP (4 T/ Strokes)



REF			
REC40145	1/4"		
REC40155	5/16"		
REC40165	3/8"		
REC40135	5/16"	3/8"	



De metal y cristal. Montaje  
en línea.  
Racors para mangueras de  
6-8-10 mm.

In-line.  
Clear body permits visual  
inspection.  
Racors 6-8-10 mm.

Di metallo e cristallo.  
Montare in linea.  
Raccordi per tubi da  
6-8-10 mm.

En métal et verre.  
Montage en ligne  
Raccors pour tuyaux  
6-8-10 mm.

REF		
GS30435	6, 8, 10 mm	1



**FILTRO COMBUSTIBLE  
SEPARADOR DE AGUA**

**WATER SEPARATING FUEL  
FILTER**

**FILTRO SEPARATORE  
ACQUA-BENZINA**

**FILTRE À CARBURANT  
SÉPARATEUR D'EAU**

REF	MICRAS MICRON	
REC24942	10	4-7/16"
REC35-802893Q01	10	4-7/16"
REC855686	28	4-7/16"
REC35-802893Q	25	3-3/4"
RACPFF5510	10	4-7/16"

**RACOR**



RACPFF5510



REC24942    REC35-802893Q01    REC855686    REC35-802893Q

Filtro original.    OEM filter.    Filtro benzina originale.    Filtre d'origine

REF	MICRAS MICRON	
RM35-802893Q	10	3-3/4"



**FILTRO CON BRACKET**  
Bracket de Aluminio.  
Con 2 tapones de bronce y 1 tubo de extensión.

**OEM FILTER WITH BRACKET**  
Cast Aluminium Bracket.  
With 2 brass plugs & 1 extension tube.

**FILTRO BENZINA CON SUPPORTO**  
Supporto in alluminio.  
Con 2 tappi di bronzo e 1 tubo di estensione.

**FILTRE AVEC SUPPORT**  
Support en aluminium  
Avec 2 bouchons en bronze et 1 tube d'extension.



REF	MICRAS MICRON		
REC24950	25	1/4"	50 GPH
REC24952	10	1/4"	50 GPH

**FILTRO DECANTADOR  
GASOLINA**

**COMPLETE FUEL FILTER**

**FILTRO DECANTATORE  
BENZINA**

**FILTRE DÉCANTEUR POUR  
ESSENCE**

Filtro de combustible con braket.

Complete fuel filter with braket.

Filtro combustibile con supporto.

Filtre à carburant avec support.

REF		
RAC23299-10	RAC23289-10	130 HP (4 T/ Strokes)

**RACOR**



REF	OEM		MICRAS MICRON		
REC90794-46866	907-94469-05	REC90794-46868	10	117 l/h	175 hp



**LLAVE PARA FILTRO  
FILTER KEY  
CHIAVE DA FILTRO  
CLE A FILTRE**

REF
RECYS-225-15



Consultar filtros específicos para una marca en su catálogo.  
Consult specific filters for a brand in his catalog.  
Consulta i filtri specifici per un marchio nel suo catalogo.  
Consulter les filtres spécifique à une marque dans votre catalogue.





**FILTRO DECANTADOR GASOLINA**      **COMPLETE FUEL FILTER**      **FILTRO DECANTATORE BENZINA**      **FILTRE DÉCANTEUR POUR ESSENCE**

**RACOR.**



	RAC120R-RAC-01	RAC320R-RAC-01	RAC320R-INOX-01	RAC320R-RAC-02
<b>FLUJO MÁXIMO</b> MAX. FLOW FLUSSO MASSIMO FLUX MASSIMALE	114 l/h 30 gph	340 l/h 60 gph	340 l/h 60 gph	340 l/h 60 gph
<b>ELEMENTO</b> ELEMENT ELEMENTO ELEMENT	RACS3240	RACS3213	RACS3213	RACS3220UL
<b>CAZOLETA TRANSPARENTE</b> (sólo se recomienda para fueraborda.) CLEAR BOWL (Just for outboards) VASCHETTA TRASPARENTE (Solo nei fuoribordo.) CAZOLETA TRANSPARENTE (Uniquement recommandé pour le hors-bord.)	✓	✓	✓	✗
<b>ROSCAS CENTRALES</b> CENTRAL THREADS FILETTO CENTRALE FILS CENTRAUX	M18 x 1.5	1 1/4"	1 1/4"	1 1/4"
<b>TAMAÑO ROSCA CABEZA</b> HEAD PORT SIZE DIMENSIONE VITE TESTA TAILLE DU FIL DE TÊTE	1/4-18 NPTF	1/4-18 NPTF	1/4-18 NPTF	1/4-18 NPTF
<b>ALTURA X Ø</b> HEIGHT X Ø ALTEZZA X Ø HAUTEUR X Ø	166 x 81 x 81 mm	238 x 102 x 102 mm	238 x 102 x 102 mm	238 x 102 x 102 mm
<b>PESO</b> WEIGHT PESO POIDS	0,5 kg	0,9 kg	0,9 kg	0,9 kg
<b>CAIDA DE PRESIÓN</b> PRESSURE DROP CADUTA DI PRESSIONE CHUTE DE PRESSION	0.15 PSI 0.01 bar	0.61 PSI 0.04 bar	0.61 PSI 0.04 bar	0.61 PSI 0.04 bar
<b>PRESIÓN MÁXIMA</b> MAX. PRESSURE PRESSIONE MASSIMA PRESSION MAXIMALE	7 PSI 0.05 bar	7 PSI 0.05 bar	7 PSI 0.05 bar	7 PSI 0.05 bar
<b>DESMONTAJE CARTUCHO-CAZOLETA</b> ELEMENT REMOVAL UNDERBOWL RIMOZIONE DELLA CARTUCCIA DEMONTAGE DE LA CARTOUCHE	25,4 mm 1"	25,4 mm 1"	25,4 mm 1"	25,4 mm 1"
<b>TEMPERATURA DE TRABAJO</b> OPERATING TEMPERATURE TEMPERATURA DI LAVORO TEMPERATURE DE TRAVAIL	-40°C +124°C			

ELEMENTOS DE RECAMBIO		ELEMENT	ELEMENTI DI RICAMBIO	CARTOUCHE DE RECHANGE
REF	R.OM. OEM	FILTRO FILTER FILTRO FILTRE		
RACS3240		RAC120R-RAC-01	LENS3240	RACS3240
LENS3240			LENS3227	RACS3227
RACS3227	YMM-2E227-00	Yamaha-Suzuki	LENS3214	RACS3214
LENS3227				
RACS3213		RAC320R-RAC-01		
LENS3213		RAC320R-RAC-01 INOX		
		RAC320R-RAC-03		
RACS3214		Johnson & Evinrude		
RACS3228UL		RAC320R-RAC-02, con/with/con/avec bracket RACOR		RACS3228UL

RÁCORES		RACORS	RACCORDI	RACCORDS
Para   for   per   pour: RAC120R-RAC-01, RAC320R-RAC-01, RAC320R-RAC-02				
REF		90°	0°	
GS31065	1/4" NPT	3/8"		1
GS31066	1/4" NPT		5/16"	2
GS31067	1/4" NPT		3/8"	2



SISTEMA ELÉCTRICO ELECTRIC SYSTEM SISTEMA ELETTRICO SYSTÈME ÉLECTRIQUE

FUSIBLE ATC		MARINE FUSES ATC	FUSIBILE ATC	FUSIBLE ATC
Ref				
		(mm)		
GS11501	3 A	19 x 19	3 A	19 x 19
GS11502	4 A	19 x 19	5 A	19 x 19
GS11503	10 A	19 x 19	7,5 A	19 x 19
GS11504	15 A	19 x 19	10 A	19 x 19
GS11505	20 A	19 x 19	15 A	19 x 19
GS11506	30 A	19 x 19	20 A	19 x 19
		5	25 A	19 x 19
			30 A	19 x 19
			40 A	19 x 19



Con LED indicador de fundido. With illuminated LED when blown. Con indicatore LED. Avec indicateur LED.



FUSIBLE ATM		MARINE FUSES ATM	FUSIBILE ATM	FUSIBLE ATM
Ref				
		(mm)		
AM603905	5 A	11 x 16		
AM603910	10 A	11 x 16		
AM603915	15 A	11 x 16		
AM603920	20 A	11 x 16		
AM603930	30 A	11 x 16		



FUSIBLE MAXI		FUSES MAXI	FUSIBILE MAXI	FUSIBLE MAXI
Contactos estañados para resistir a la corrosión. Tin plated connector blades for corrosion resistance. Connettori stagni per resistere alla corrosione. Contacts étamés pour résister à la corrosion.				
Ref				
BS5138	30 A	1		
BS5139	40 A	1		
BS5140	50 A	1		
BS5141	60 A	1		
BS5142	70 A	1		
BS5143	80 A	1		

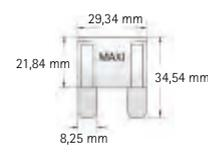

**DESCONECTOR DE SEGURIDAD**

Interruptor de encendido para motores. Aísla los circuitos en unidades dobles para prevenir el retorno al alternador.

**IGNITION KILL SWITCHES**

Emergency and stop switch. Isolates circuits on dual units to prevent feedback.

**INTERRUTTORE DI STOP**

Interruttore di accensione per motori. Isola i circuiti in doppie unità per prevenire il ritorno all'alternatore.

**INTERRUPTEUR DE SECURITE**

Contacteur d'allumage pour moteurs. Isolez les circuits en unités doubles pour empêcher le retour à l'alternateur.

REF					
THKS-1	Un fueraborda	Single outboard	Un fuoribordo	Un hors-bord	1
THKS-2	Un intraborda	Single I/O	Un entrobordeo	Un inboard	1
THKS-12	Dos fuerabordas	Dual outboard	Due fuoribordo	Deux hors-bord	1
THKS-22	Dos intrabordas	Dual I/O	Due entrobordeo	Deux inboard	1
THL-4	Cuerda recambio	Spare lanyard	Corda ricambio	Corde de rechange	1



REF	RO OEM		
REC87-823609A17	87-823609A17	Mercury / Mariner	1
REC37800-93954	37800-9354 37800-9353	Suzuki	1



REC87-823609A17



REC37800-9354

Interruptor de encendido para todo tipo de motores fueraborda o intraborda.

Emergency and stop switch for inboard or outboards.

Interruttore di accensione per tutti i tipi di motori entrobordeo e fuoribordo.

Contacteur d'allumage pour tous types de moteurs hors-bord ou in-bord.

REF					
REC40970	Conjunto completo	Complete kit	Kit completo	Ensemble complet	1
REC40990	Cuerda tirador recambio	Spare	Corda tirante ricambio	Corde de rechange	1
GS11290	Conjunto completo	Complete kit	Kit completo	Ensemble complet	1
GS11291	Cuerda recambio	Spare lanyard	Corda ricambio	Corde de rechange	1
GS11292	Kit	Kit	Kit	kit	1



REC40970- REC40990



GS11290



GS11292



GS11291

REF	RO OEM		
REC37830-89E03	37830-84E03	Suzuki	1
REC37820-92E03	37820-92E00	Suzuki	1
REC69W-82575-00	69W-82575-0	Yamaha / Mariner	1
REC688-82575-01	688-82575-01	Yamaha / Mariner	1
REC200		Mercury / Mariner	1
REC369-0682-0	369-0682-00	Tohatsu	1



REC69W-82575-00



REC688-82575-01



REC37830-89E03

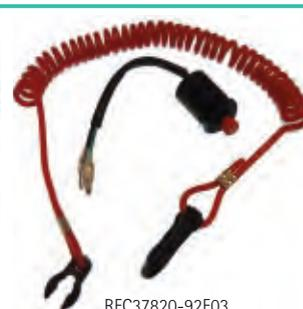

REC37820-92E03



REC369-0682-0



REC200

KITS LLAVES		KILL SWITCHES KEYS	KIT CHIAVI	KITS DE CLÉS
REF				
GS11294	Johnson / Evinrude OMC Mercury Yamaha Honda Suzuki Tohatsu	1		

LLAVE DE ARRANQUE		IGNITION STARTER SWITCHES	CHIAVE DI AVVIAMENTO	CONTACTEUR À CLÉ
3 posiciones con retroceso, Off-Contacto-Arranque (Choke). Poliester anticorrosión.		3 positions, Off-Run-Start. Magneto.	3 posizioni con ritorno: Off-Contatto-Avviamento. Poliester anticorrosione.	3 positions, Off-Contact-Start (Choke). Polyester anti-corrosion.
REF	PANELES PANELS PANNELLI PANNEAUX	TERMINALES TERMINALS TERMINALI BORNES	POSICIONES POSITIONS POSIZIONE POSITIONS	
MP39200	28 mm	3	3	1

3 posiciones con retroceso, Off-Contacto-Arranque. Poliester anticorrosión.		3 positions, Off-Run-Start. Conventional	3 posizioni con ritorno: Off-Contatto-Avviamento. Poliester anticorrosione.	3 positions, Off-Contact-Start. Polyester anti-corrosion.
REF	RO OEM	TERMINALES TERMINALS TERMINALI BORNES	POSICIONES POSITIONS POSIZIONE POSITIONS	
MP39760	393301 508180	5 + 1	3	1

3 posiciones con retroceso, Off-Contacto-Arranque (Choke). Poliester anticorrosión. Para fuerabordas Mercury y Mariner.		3 positions, Off-Run-Start. Magneto	3 posizioni con ritorno: Off-Contatto-Avviamento. Poliester anticorrosione. Per fuoribordo Mercury e Mariner.	3 positions, Off-Contact-Start (Choke). Polyester anti-corrosion. Pour les moteurs hors-bord Mercury et Mariner.
REF	RO OEM	TERMINALES TERMINALS TERMINALI BORNES	POSICIONES POSITIONS POSIZIONE POSITIONS	
MP41070	MC 87-17009A2, 87-17009A5	6	3	1

3 posiciones con retroceso, Off-Contacto-Arranque (Choke). Poliester anticorrosión. Para fuerabordas Mercury y Mariner.		3 positions, Off-Run-Start. Magneto.	3 posizioni con ritorno: Off-Contatto-Avviamento. Poliester anticorrosione. Per fuoribordo Mercury e Mariner.	3 positions, Off-Contact-Start (Choke). Polyester anti-corrosion. Pour les moteurs hors-bord Mercury et Mariner.
REF	RO OEM	TERMINALES TERMINALS TERMINALI BORNES	POSICIONES POSITIONS POSIZIONE POSITIONS	
MP41000	MC 87-88107	6	3	1

3 posiciones con retroceso, Off-Contacto-Arranque. Poliester anticorrosión. Montadas por Bayliner y SeaRay (1990+).		3 positions, Off-Run-Start. Conventional.	Chiave di avviamento a 3 posizioni con ritorno: Off-Contatto-Avviamento. Poliester anticorrosione. Montato da Bayliner e SeaRay dall'anno 1990.	3 positions, Off-Contact-Start. Polyester anti-corrosion. Assemblé par Bayliner et SeaRay (1990+).
REF	PANELES PANELS PANNELLI PANNEAUX	TERMINALES TERMINALS TERMINALI BORNES	POSICIONES POSITIONS POSIZIONE POSITIONS	
MP41030	15 mm	3	3	1

3 posiciones con retroceso, Off-Contacto-Arranque. Fabricada en latón con frontal cromado. Chrome plated brass face nut and brass back-up nut.		3 positions with return, Off-Ignition-Start.	3 posizioni con ritorno Off-Contatto-Avviamento. In ottone con frontale cromato.	3 positions, Off-Contact-Start. Fabriqué en laiton avec façade chromée. Ecrou frontal en laiton chromé et écrou d'appui en laiton.
REF	PANELES PANELS PANNELLI PANNEAUX	TERMINALES TERMINALS TERMINALI BORNES	POSICIONES POSITIONS POSIZIONE POSITIONS	
GS11150	28 mm	3, 15A 12V	3	1



Fabricada en latón con frontal protector de goma. 3 posiciones con retroceso, Off-Contacto-Arranque.

Made in brass with rubber cap protector. 3 positions with return, Off-Ignition-Start.

Prodotta in ottone con parte frontale in gomma, 3 posizioni con ritorno, Off-Contatto-Avviamiento.

En laiton avec façade de protection en caoutchouc. 3 positions: Off-Contact-Start.

REF	TERMINALES TERMINALS TERMINALI BORNES	POSICIONES POSITIONS POSIZIONE POSITIONS	
GS11151	3	3	1
GS11154	4	3	1



Plástico con frontal protector de goma. 3 posiciones con retroceso, Off-Contacto-Arranque.

Made in plastic with rubber cap protector. 3 positions with return, Off-Ignition-Start.

In plastica con parte frontale in gomma 3 posizioni con ritorno, Off-Contatto-Avviamiento.

Plastique avec façade de protection en caoutchouc. 3 positions: Off, contact et démarrage.

REF	TERMINALES TERMINALS TERMINALI BORNES	POSICIONES POSITIONS POSIZIONE POSITIONS	
GS11152	3	3	1
GS11153	5	3	1



Plástico. 4 posiciones con retroceso, Accesorios-Off-Contacto-Arranque.

Made in plastic with rubber cap protector. 4 positions with return, Acc-Off-Ignition-Start.

Prodotta in plastica. 4 posizioni con ritorno, Blower-Off-Contatto-Avviamiento.

Plastique 4 positions avec recul, Accessoires-Off-Contact-Start.

REF	PANELES PANELS PANNELLI PANNEAUX	TERMINALES TERMINALS TERMINALI BORNES	POSICIONES POSITIONS POSIZIONE POSITIONS	
GS11155	15 mm = 5/8"	7	4	1
GS11156	6 mm = 1/4"	7	4	1



Fabricada en plástico. 3 posiciones con retroceso, Off-Contacto-Arranque (Starter).

Made in plastic. 3 positions with return, Off-Ignition-Start (Choke).

Prodotta in plastica. 3 posizioni con ritorno, Off-Contatto-Avviamiento (Starter).

En plastique. 3 positions avec recul, démarreur sans contact.

REF	PANELES PANELS PANNELLI PANNEAUX	TERMINALES TERMINALS TERMINALI BORNES	POSICIONES POSITIONS POSIZIONE POSITIONS	
GS11158	15 mm = 5/8"	6	3	1
GS11157	6 mm = 1/4"	6	3	1



Fabricada en plástico. Con cables incluidos. 3 posiciones con retroceso, Off-Contacto-Arranque (Starter).

Made in plastic. 3 positions with return, Off-Ignition-Start (Choke). With wires included.

Prodotta in plastica. Con cavi inclusi. 3 posizioni con ritorno, Off-Contatto-Avviamiento (Starter).

En plastique. Avec câbles inclus. 3 positions avec recul, démarreur sans contact.

REF	TERMINALES TERMINALS TERMINALI BORNES	POSICIONES POSITIONS POSIZIONE POSITIONS	
GS11159	6	3	1



LUBRICANTES Y PINTURAS

LUBRICANTS & PAINTS

LUBRIFICANTI E PITTURE

LUBRIFIANTS ET PEINTURES

PINTURA EN SPRAY

SPRAY PAINT

PITTURE SPRAY

PEINTURE EN SPRAY

Sprays de pintura con los colores originales para retoque de los motores fueraborda, interiores, intra-fueraborda y colas fueraborda más usuales. Capacidad: 400ml.

Spray paints with the original colors for maintenance and painting inboards and outboard marine engine as well as stern-drives units. Bottle: 400ml.

Vernice spray con i colori originali per ritocchi dei motori fuoribordo, entro-bordo, entro-fuoribordo e i piedi. Capacità: 400ml.

Peinture en aérosol aux couleurs originales pour la retouche des moteurs hors-bord, in-bord et les embases les plus courantes. Capacité: 400 ml

REF	COLOR	COLOUR	COLORE	COULEUR
GS90019	Barniz transparente	Clear Varnish	Vernice trasparente	Vernis transparent
PS110410	Evinrude Azul (1989)	Blue (1989)	Blu (1989)	Bleu (1989)
GS90037	Evinrude Azul XP	Blue XP	Blu XP	XP bleu
PS111139	Honda Gris Beige (1991)	Grey (1991)	Grigio-Beige (1991)	Gris Beige (1991)
GS90038	Honda Gris metalizado	Grey Metal	Grigio metallizzato	Gris métallisé
GS90023	Honda Plata met.	Silver Metal	Argento metallizzato	Argent métallisé
GS90030	Johnson Blanco (1972-90) - (1993+)	White (1972-90) - (1993+)	Bianco (1972-90) - (1993+)	Blanc (1972-90) - (1993+)
GS90026	Johnson Blanco (1981-83)	White (1981-83)	Bianco (1981-83)	Blanc (1981-83)
GS90039	Johnson Plata metalizado	Silver Metal	Argento metallizzato	Argent métallisé
GS90040	Mariner Gris	Grey	Grigio	Gris
GS90002	Mercury Negro	Black	Nero	Noir
GS90049	Parsun Negro	Black	Nero	Noir
GS90032	Suzuki Plateado (1983-89)	Silver (1983-89)	Argento (1983-89)	Argent (1983-89)
GS90025	Suzuki Gris metalizado	Grey Metal	Grigio metallizzato	Gris métallisé
GS90042	Suzuki Negro metalizado	Black Metal	Nero Metallizzato	Noir métallisé
GS90024	Tohatsu Gris Metal (1991)	Grey Metal (1991)	Grigio Metallizzato (1991)	Gris métallisé (1991)
GS90027	Tohatsu Azul Cobalto (1988-90)	Blue Cobalt (1988-90)	Blu Cobalto (1988-90)	Bleu cobalt (1988-90)
GS90043	Tohatsu Azul	Blue	Blu	Bleu
PS114694	Yamaha Azul Metal (1974)	Blue Metal (1974)	Blu Metallizzato (1974)	Bleu métal (1974)
GS90021	Yamaha Azul (1984+)	Blue (1984+)	Blu (1984+)	Bleu (1984+)
GS90020	Yamaha Azul Origen	Blue Origin	Blue Origen	Bleu Origine
GS90022	Yamaha Gris Metal (1994)	Grey Metal (1994)	Grigio Metallizzato (1994)	Gris métallisé (1994)
PS110485	Yamaha Gris Capot (1994)	Grey Capot (1994)	Grigio Capot (1994)	Gris capot (1994)



GOLDENSHIP

PROTECTOR DE MOTOR

ENGINE PROTECTOR

PROTETTORE MOTORE

PROTECTION DU MOTEUR

Producto a base de aceites y grasas que protege del óxido y la corrosión las superficies exteriores y partes eléctricas de los motores durante el invierno. Evita la formación de agarrotamientos debido a la presencia de salitre. Facilita el arranque eliminando los residuos de agua y humedad. Se elimina fácilmente.

Oil Et grease made, protects from rust Et corrosion external engine surface during winter storage. Removes salt deposit and loosens rusted parts. Easy to remove.

Prodotto a base di olio e grasso che protegge dall'ossidazione e dalla corrosione le superfici esterne e parti elettriche dei motori durante l'invernaggio. Evita la formazione dell'ossidazione dovuta alla presenza del salmastro. Facilita l'accensione eliminando i residui di acqua e umidità. Si elimina facilmente.

Produit à base d'huiles et de graisses qui protège les surfaces extérieures et les parties électriques des moteurs de la rouille et de la corrosion pendant l'hivernage. Il empêche la formation de crises dues à la présence de salpêtre. Il facilite le démarrage en éliminant les résidus d'eau et d'humidité. Il s'enlève facilement.



REF	
GS90090	500 ml

GOLDENSHIP

PROTECTOR DIELECTRICO

DIELECTRIC PROTECTOR

PROTETTORE DIELETRICO

PROTECTEUR DIÉLECTRIQUE

Protector dieléctrico antihumedad para uso marino. Protege de la humedad y oxidación todos las partes eléctricas y mecánicas de los motores marinos. Ideal para invernaje de motores y mantenimiento de temporada.

Prevents humidity and corrosion of all electric and mechanical parts in marine engines. Specially indicate for winter storages and maintenance in the season.

Protettore dielettrico anti-umidità per uso marino. Protegge dalla umidità e dall'ossidazione tutte le parti elettriche e meccaniche dei motori marini. Ideale per invernaggio dei motori e manutenzione di lunga durata.

Protecteur diélectrique anti-humidité pour usagé marin. Protège toutes les pièces électriques et mécaniques des moteurs marins contre l'humidité et l'oxydation. Idéal pour l'hivernage des moteurs et l'entretien saisonnier.



REF	
GS90092	400 ml

GOLDENSHIP

DESCALCIFICADOR DE MOTOR	DESCALING ENGINE FLUSH	DECALCIFICANTE MOTORE	DÉTARTRANT MOTEUR
<p>Limpiador para eliminar las incrustaciones, algas, y suciedad en los motores marinos. No daña las juntas ni impulsores de goma.</p>	<p>Removes scale, zebra mussels, general marine growth and vegetation rom all marine engines.</p>	<p>Pulitore per eliminare le incrostazioni, alghe, e sporcizia nei motori marini. Non danneggia guarnizioni e giranti in gomma.</p>	<p>Nettoyant pour éliminer le tartre, les algues et la saleté dans les moteurs marins. N'endommage pas les joints ou les turbines en caoutchouc.</p>
<p>REF STA92600</p> <p>3,8 L</p> 			

LIMPIADOR CARBURADOR Y STARTER	CARBURATOR & CHOKE CLEANER	PULITORE CARBURATORE	NETTOYANT CARBURATEUR
<p>Aerosol para motores de 2 y 4 tiempos. Para limpieza del carburador y de los componentes internos del motor. Asegura arranques fáciles y ralenti suave. Despega los aros de los pistones. Restablece la potencia del motor.</p>	<p>Spray for all 2 and 4 cycle engines. Marine motor de-carb. Dissolves gum, varnish dirt and carbon deposits. Restore power &amp; performance. Reduce fuel consumption.</p>	<p>Aerosol per motori di 2 e 4 tempi. Per la pulizia del carburatore e dei componenti interni del motore. Assicura partenze più facili e un minimo stabile. Lubrifica le fasce dei pistoni. Ristabilizza la potenza del motore.</p>	<p>Spray pour moteurs 2 et 4 temps. Pour nettoyer le carburateur et les composants internes du moteur. Assure des démarrages faciles et un ralenti en douceur. Décolle les segments du piston. Restaure la puissance du moteur.</p>
<p>REF GEGC15</p> <p>354 g</p> 			

ACEITE DE INVERNAJE	FOGGING OIL	OLIO INVERNAGGIO	FOGGING OIL
<p>Para inyectar en los carburadores de motores a 2 y 4 tiempos. Protege las paredes de los cilindros, aros de pistones y otras superficies de la cámara de combustión durante los periodos de invierno, facilitando el arranque del motor después de éste periodo.</p>	<p>Prevents corrosion when storing inboard or outboard engines for a extended period of time. Special formula makes starting engine after storage quick and easy.</p>	<p>Da inserire nei carburatori dei motori da 2 e 4 tempi. Protegge le pareti dei cilindri, le fasce dei pistoni e altre superfici della camera di combustione durante il periodo di invernaggio, facilitando la partenza del motore dopo questo periodo.</p>	<p>Pour injecter dans les carburateurs des moteurs 2 et 4 temps. Il protège les parois des cylindres, segments et autres surfaces de la chambre de combustion pendant les périodes d'hivernage, facilitant le démarrage du moteur après cette période.</p>
<p>REF STA84800 GE22001</p> <p>3,8 L 340 g</p>		<p>RECmar® GE22001</p>	 <p>STA84800</p>

ADITIVO GASOLINA	GASOLINE ADDITIVE	ADDITIVO BENZINA	ADDITIF ESSENCE
<p>Elimina y previene los problemas del etanol. Reduce todas las emisiones contaminantes. Estabiliza la química del combustible durante 1 año. Reduce el mantenimiento del sistema de combustible. Elimina la producción de carbonilla. Reduce el consumo de combustible.</p>	<p>Eliminates and prevents ethanol fuel problems. Reduces all emissions. Prevents fuel oxidation and stabilizes fuel chemistry for at least 1 year. Lower fuel system maintenance. Eliminates carbon build-up. Increases fuel economy.</p>	<p>Elimina e previene i problemi dell'etanolo. Riduce tutte le emissioni contaminanti. Stabilizza la chimica del combustibile durante 1 anno. Elimina la produzione di residui carboniosi. Riduce il consumo del combustibile.</p>	<p>Élimine et prévient les problèmes d'éthanol. Réduise toutes les émissions polluantes. Stabilise la chimie du carburant pendant 1 an. Réduit l'entretien du système de carburant. Élimine la production de charbon. Réduis la consommation de carburant.</p>
<p>REF STA93008 STA93016</p> <p>237 ml 473 ml</p> <p>PARA TRATAR HASTA TREAT UP TRATTARE FINO A POUR TRAITER JUSQU'À 475 L 950 L</p> 			

ESTABILIZADOR DE GASOLINA	FUEL STABILIZER	STABILIZZATORE BENZINA	STABILISATEUR D'ESSENCE												
<p>Elimina el agua, limpia los carburadores e inyectores. Contiene antioxidantes para prevenir el óxido y la corrosión. No requiere vaciar el depósito para el invierno y mantiene el combustible fresco para un rápido y fácil arranque.</p>	<p>Keeps fuel fresh and allows for easier starts after periods of storage. Removes water, cleans carburetors and fuel injectors. Contains antioxidant to prevent rust and corrosion.</p>	<p>Elimina l'acqua, pulisce i carburatori e iniettori. Contiene antiossidanti per prevenire l'ossidazione e la corrosione. Non è necessario svuotare il serbatoio per l'invernaggio e mantiene il carburante fresco per una rapida e facile partenza.</p>	<p>Élimine l'eau, nettoie les carburateurs et les injecteurs. Contient des antioxydants pour empêcher la rouille et la corrosion. Il ne nécessite pas de vider le réservoir pour l'hivernage et maintient le carburant frais pour un démarrage rapide et facile.</p>												
<p>PARA TRATAR HASTA TREAT UP TRATTARE FINO A POUR TRAITER JUSQU'À</p> <table border="1"> <thead> <tr> <th>REF</th> <th>475 ml</th> <th>150 L</th> <th>Gasolina   Gasoline   Benzina   Gasoline</th> </tr> </thead> <tbody> <tr> <td>GE22207</td> <td>475 ml</td> <td>150 L</td> <td>Gasolina   Gasoline   Benzina   Gasoline</td> </tr> <tr> <td>GE22254</td> <td>946 ml</td> <td>1.200 L</td> <td>Diesel</td> </tr> </tbody> </table>				REF	475 ml	150 L	Gasolina   Gasoline   Benzina   Gasoline	GE22207	475 ml	150 L	Gasolina   Gasoline   Benzina   Gasoline	GE22254	946 ml	1.200 L	Diesel
REF	475 ml	150 L	Gasolina   Gasoline   Benzina   Gasoline												
GE22207	475 ml	150 L	Gasolina   Gasoline   Benzina   Gasoline												
GE22254	946 ml	1.200 L	Diesel												
															
															
			<p>GE22207                      GE22254</p>												

LIMPIADOR DEPOSITOS	FUEL TANK CLEANER	PULITORE SERBATOIO	NETTOYANT RÉSERVOIR									
<p>Excepcionalmente efectivo en la limpieza de lodos y algas en depósitos de gasolina o diesel. Retrasa la formación de nuevas algas que puedan contaminar el combustible. Nuevo y revolucionario aditivo que reemplaza los costosos sistemas de limpieza de los depósitos de combustible.</p>	<p>Exceptionally effective at cleaning sludge and algae from gasoline and diesel tanks. Slows the recurrence of new algae that can contaminate fuel. A revolutionary new additive that replaces expensive fuel polishing and tank cleaning.</p>	<p>Eccezionale efficacia nella pulizia dal fango e alghe nel serbatoio benzina o diesel. Ritarda la formazione di nuove alghe che possono contaminare il combustibile. Nuovo e rivoluzionario additivo che rimpiazza i costosi sistemi di pulizia dei serbatoi del combustibile.</p>	<p>Exceptionnellement efficace pour nettoyer les boues et les algues dans les réservoirs d'essence ou de diesel. Il retarde la formation de nouvelles algues qui peuvent contaminer le carburant. Nouvel additif révolutionnaire qui remplace les systèmes coûteux de nettoyage des réservoirs de carburant.</p>									
<p>PARA TRATAR HASTA TREAT UP TRATTARE FINO A POUR TRAITER JUSQU'À</p> <table border="1"> <thead> <tr> <th>REF</th> <th>1,9 L</th> <th>950 L</th> </tr> </thead> <tbody> <tr> <td>STA93664</td> <td>1,9 L</td> <td>950 L</td> </tr> <tr> <td>STA93116</td> <td>473 ml</td> <td>1.900 L</td> </tr> </tbody> </table>				REF	1,9 L	950 L	STA93664	1,9 L	950 L	STA93116	473 ml	1.900 L
REF	1,9 L	950 L										
STA93664	1,9 L	950 L										
STA93116	473 ml	1.900 L										
												
												
			<p>STA93116                      STA93664</p>									

LUBRICANTE PARA 2 TIEMPOS	2 STROKE LUBRICANT	LUBRICANTE PER 2 TEMPI	HUILE 2 TEMPS TC-W3									
<p><b>2 STROKES TC-W3</b></p>												
<p>Especialmente formulado para motores marinos de 2 tiempos. Inhibidor de corrosión y herrumbre. Gran capacidad de limpieza de las partes internas del motor (pistón, bujías...), evita el pegado de segmentos y la formación de depósitos. Alta fluidez a bajas temperaturas.</p>	<p>Specially formulated for 2-stroke marine engines. Excellent anti-wear protection for the internal parts of the engine. When the engine is not in use, it effectively protects from corrosion and rust. Very effective in maintaining the internal parts of the engine (pistons, spark plugs, etc.) clean, avoiding piston rings from sticking and sediments accumulating.</p>	<p>Formulazione specificamente studiata per motori marino a 2 tempi. Eccellente protezione contro l'usura dei componenti interni del motore. Garantisce un'alta protezione contro la corrosione e la ruggine. Contribuisce a mantenere pulite le parti interne del motore (pistone, candela, ecc.), evita l'aderenza delle fasce del pistone e la formazione di depositi. Alta fluidità a basse temperature.</p>	<p>Spécialement conçu pour des moteurs 2 temps, Elle vous offre une excellente protection face à l'usure des éléments internes du moteur et une haute protection contre la corrosion et la rouille. Elle a une haute fluidité à basses températures. Notamment applicable dans des conditions climatiques très froides.</p>									
<p>QUALITY LEVELS NMMA TC-W3 (NMMA, National Marine Manufacturers Association)</p>												
<table border="1"> <thead> <tr> <th>REF</th> <th>1 L</th> <th>6</th> </tr> </thead> <tbody> <tr> <td>REC2TU6</td> <td>1 L</td> <td>6</td> </tr> <tr> <td>REC2TU3</td> <td>5 L</td> <td>3</td> </tr> </tbody> </table>				REF	1 L	6	REC2TU6	1 L	6	REC2TU3	5 L	3
REF	1 L	6										
REC2TU6	1 L	6										
REC2TU3	5 L	3										
												
												
<p style="text-align: right;"><b>new</b></p>												



### ACEITE MEZCLA 2 TIEMPOS

### 2 CYCLE OIL S

### OLIO MISCELA 2 TEMPI

### HUILE 2 TEMPS

REF	R.O. OEM			
RM92-858026QB1U6	92-858026QB1	1 L	6	PREMIUM PLUS
RM92-858027QB1U3	92-858027QB1	3,8 L	3	PREMIUM PLUS
RM92-858037QB1U3	92-858037QB1	3,8 L	3	OPTIMAX /DFI



RM92-858026QB1U6



RM92-858027QB1U3



RM92-858037QB1U3

### ACEITE MINERAL FUERABORDAS TC-W3

Utilize el TC-W3 para obtener mayor potencia en su motor. Provee de una mayor protección contra la carbonilla en los pistones, el resacamiento de los aros, el fallo de las bujías en el arranque y del óxido. Recomendado para los sistemas de inyección de aceite.

### 2-CYCLE OIL TC-W3

Formulated from ultra-clean base stock oil to provide superior protection against piston scuffing, bearing wear, spark plug fouling, pre-ignition and rust. This formulation has outstanding lubricity and miscibility for better mixing of fuel and oil, resulting in a cleaner running engine. Contains no phosphorus. Recommended for oil injection systems. Outboard motor Oil.

### OLIO MINERALE PER FUORIBORDO TC-W3

Utilizzare il TC-W3 per ottenere maggior potenza nel motore. Fornisce una maggiore protezione contro i residui di combustione nei pistoni, l'essiccazione delle fasce, il non funzionamento delle candele nell'accensione. Raccomandato per i sistemi di iniezione ad olio.

### HUILE MINÉRALE 2 TEMPS TC-W3

Utilisez la TC-W3 pour augmenter la puissance de votre moteur. Elle offre une meilleure protection contre le carbone dans les pistons, le séchage des segments, la défaillance des bougies d'allumage au démarrage et la rouille. Recommandé pour les systèmes d'injection d'huile.

REF	R.O. OEM			
LUB11591U12		1 L	12	
RM92-858021QB1U6	92-858021QB1	1 L	6	
RM92-858022QB1U3	92-858022QB1	3,8 L	3	
RM92-858023QB1U2	92-858023QB1	9,5 L	2	



LUB11591U12



RM92-858021QB1U6



RM92-858022QB1U3



RM92-858023QB1U2

### SAE 5W40

### ACEITE 100% SINTÉTICO

Lubricante marino 100% sintético. Excelente fluidez en frío, facilita el arranque y reduce los desgastes de motor. Evita el pegado de segmentos al dispersar lodos, barnices y otros productos de oxidación a altas temperaturas. Contiene inhibidores antiherrumbre y anticorrosión.

### 100% SYNTHETIC OIL

100% synthetic lubricant designed for all types of 4T petrol engines. Good fluidity in cold temperatures facilitates performance and reduces engine wear. It avoids piston rings from sticking by clearing dirt, varnish and other oil oxidation deposits when subject to high temperatures. Contains effective anti-rust and anti-corrosion inhibitors that protect the engine in the marine environment.

### OLIO 100% SINTETICO

Lubrificante 100% sintetico pensato per motori a benzina 4T di ogni tipo. Buona fluidità a freddo, facilita la messa in moto e riduce l'usura del motore. Evita l'aderenza delle fasce del pistone, disperdendo fanghi, lacche e altri prodotti derivanti dall'ossidazione dell'olio ad alte temperature. Contiene efficaci inibitori antiruggine e anticorrosione, per proteggere il motore in ambiente marino.

### HUILE 100% SYNTHÉTIQUE

Lubrifiant 100% synthétique adapté à tout type de moteurs à essence 4T. Bonne fluidité à froid qui aide au démarrage et réduit la détérioration du moteur. Évite le collage des segments lors de la dispersion de boue dans le moteur, vernis et autres produits oxydant l'huile à haute température. Contient des inhibiteurs de corrosion et antirouille.

new

QUALITY LEVELS  
API SN/CF  
ACEA A3/B3/B4  
MB 229.3  
VW 502.00/505.00  
RN 710  
OPEL A&B  
JASO MA2



REF		
REC5W40U6	1 L	6
REC5W40U3	5 L	3



Especialmente desarrollado para motores de alto rendimiento. Las propiedades especiales de este aceite le permiten lubricar el motor incluso durante el arranque a baja temperatura. El aceite combate la acumulación de lodo y brinda una excelente protección contra el desgaste. Especialmente adecuado para motores que están sujetos a arranques y paradas frecuentes.

Specially developed for high performance engines. The special properties of this oil allow it to lubricate the engine even during low temperature starting. The oil combats sludge build-up and gives excellent protection against wear. Particularly suitable for engines that are subject to frequent starting and stopping.

Sviluppato appositamente per motori ad alte prestazioni. Le proprietà speciali di questo olio consentono di lubrificare il motore anche durante l'avviamento a bassa temperatura. L'olio combatte il fango accumulato e offre un'eccellente protezione contro l'usura. Particolarmente adatto per motori soggetti a frequenti avviamenti e arresti.

Spécialement développé pour les moteurs hautes performances. Les propriétés particulières de cette huile vous permettent de lubrifier le moteur même lors d'un démarrage à basse température. L'huile combat l'accumulation de boue et offre une excellente protection contre l'usure. Particulièrement adapté aux moteurs soumis à des démarrages et arrêts fréquents.

REF	R.O. OEM			API SM
REC21363429	21363429	1 L	6	
REC21363430	21363430	5 L	3	



REC21363429

REC21363430

**SAE 10W30  
SAE 10W40**

REF	R.O. OEM		
RM92-8M0086220U6	92-8M0086220	1 L	6
RM92-8M0086221U3	92-8M0086221	4 L	3



RM92-8M0086220U6

RM92-8M0086221U3

**ACEITE SINTÉTICO PREMIUM**

Lubricante marino reforzado con bases sintéticas, para motores gasolina 4T fueraborda e intraborda. Especificaciones NMMA FC-W. HTHS elevado, asegura viscosidad a elevadas temperaturas. Anticorrosivo con antioxidantes incorporados, elevadas propiedades antiespumantes.

**SYNTHETIC PREMIUM OIL**

Marine lubricant strengthened with a synthetic base, especially formulated for outboard and inboard 4T petrol engines, with NMMA FC-W specifications. With a high HTHS, it ensures great viscosity at high temperatures. Better anti-oxidant resistance. Improved anti-foaming properties.

**OLIO SINTETICO PREMIUM**

Lubrificante marino potenziato con basi sintetiche, specificamente formulato per motori a benzina 4T fuoribordo ed entroborio, a norma specifiche NMMA FC-W. Con indice HTHS più elevato, garantisce un'alta viscosità a temperatura elevata. Aumenta la protezione anticorrosione. Maggiore resistenza all'ossidazione. Proprietà antischiuma migliorate.

**HUILE SYNTHÉTIQUE PREMIUM**

Lubrifiant marin renforcée avec des bases synthétiques, pour les moteurs à essence 4T hors-bord et inboard avec des spécifications NMMA FC-W. Avec des HTHS supérieures, qui vous assure une haute viscosité à des températures élevées. Résistance antioxydante majeure. Propriétés anti-mousse améliorées.

QUALITY LEVELS:  
NMMA FC-31015T  
(NMMA, National Marine Manufacturers Association)  
API SJ/SG

REF		
REC10W30U6	1 L	6
REC10W30U3	5 L	3

QUALITY LEVELS  
NMMA FC-11815R  
(NMMA, National Marine Manufacturers Association)  
API SJ/SG

REF		
REC10W40U6	1 L	6
REC10W40U3	5 L	3

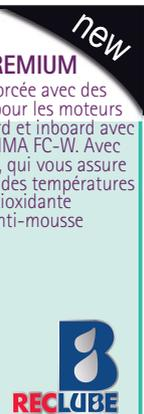

SAE 15W40

MULTIGRADE HIGH PERFORMANCE

Lubricante multigrado marino, superior al nivel SHPD, especialmente formulado para motores marinos turboalimentados. Contiene inhibidores de corrosión, oxidación, herrumbre y antiespumantes. Capacidad detergente, reduce los depósitos en válvulas y pistones. Excelentes cualidades dispersantes antilodos.

Marine multigrade oil, exceeds the SHPD performance level, especially formulated to meet the demanding requirements of 4-stroke diesel turbocharged engine manufacturers in the marine environment. Contains effective corrosion, oxidation, rust and foam inhibitors. Excellent detergent effect that reduces sediments in valves and pistons. Very good dispersion qualities that prevent sludge in cold temperatures.

Olio marino multigrado, con prestazioni oltre il livello SHPD, specificamente formulato per soddisfare le particolari esigenze dei motori diesel a 4 tempi turboalimentati in ambiente marino. Contiene efficaci inibitori contro corrosione, ossidazione, ruggini e formazione di schiuma. Eccellente capacità detergente, riduce i depositi in valvole e pistoni. Ottime qualità disperdenti che impediscono la formazione di fanghi a freddo.

Huile multigrade marine, dépasse les niveaux de performances SHPD, spécialement conçu pour les moteurs diesel 4T avec turbo. Contient des inhibiteurs contre la corrosion, l'oxydation, antirouille et anti-mousse. Evite les dommages dans les chemises, habituel sur les moteurs suralimentés de haute puissance. Haute qualité dispersante pour empêcher l'apparition de boue dans le moteur.



QUALITY LEVELS  
API CI-4/SL  
ACEA E7  
Caterpillar ECF-1<sup>a</sup>  
Cummins CES 20071/72/76/77/78  
MACK EO-M+  
MAN M3275  
MB 228.3  
MTU Level 2  
Renault RLD/RLD-2  
Volvo VDS-2 VDS-3

REF		
REC15W40U3	5 L	3



ACEITE MINERALES VDS-3

VDS-3 cubre los requisitos más estrictos sobre la limpieza del pistón en comparación con VDS-2, lo que garantiza la durabilidad y fiabilidad de los motores. La alta calidad del aceite VDS-3 permite un aumento en los intervalos de drenaje. Para motores diesel y de gasolina (ver manuales de los operadores).

VDS-3 MINERAL GEAR OILS

VDS-3 covers even more stringent requirements on piston cleanliness and bore polish compared to VDS-2, ensuring the durability and reliability of the engines. The high quality of VDS-3 oil allows in certain cases an increase in drain intervals. Fits both diesel and gas engines (check operators manuals).

OLIO MINERALE VDS-3

VDS-3 copre requisiti ancora più stringenti sulla pulizia del pistone e sulla lucidatura del foro rispetto a VDS-2, garantendo la durata e l'affidabilità dei motori. L'alta qualità dell'olio VDS-3 consente un aumento degli intervalli di scarico. Adatto sia ai motori diesel che a quelli a gas (consultare i manuali degli operatori).

HUILE MINÉRALE VDS-3

Le VDS-3 couvre les exigences les plus strictes en matière de nettoyage des pistons par rapport au VDS-2, ce qui garantit la durabilité et la fiabilité des moteurs. La haute qualité de l'huile VDS-3 permet une augmentation des intervalles de vidange. Pour les moteurs diesel et essence (voir les manuels d'utilisation).

REF	R.O. OEM		
REC22479638	22479638	1 L	API CI-4
REC22479642	22479642	5 L	ACEA E5



REC22479638

REC22479642

ACEITE MOTORES DIESEL

DIESEL ENGINES OIL

OLIO MOTORE DIESEL

HUILE MOTEUR DIESEL

REF	R.O. OEM		
RM92-8M0096794U3	92-8M0096794	3,8 L	3



SAE 25W40

ACEITE SEMISINTÉTICO 4T

Lubricante semisintético para motores con cargas y RPM elevadas. Excelentes inhibidores de corrosión, oxidación y desgaste. Buenas propiedades de arranque en frío, antiespumantes incorporados.



4 STROKES SEMI-SYNTHETIC OIL

Semi-synthetic oil for 4-stroke engines suitable for engines with high RPM and heavy loads. Lubrication of all engine components, great anti-corrosion, anti-oxidation and anti-wear properties. Good performance in cold conditions. Keeps the engine clean and increases protection against corrosion in saline water environments.

QUALITY LEVELS  
NMMA FC13101T  
(NMMA, National Marine Manufacturers Association)  
API SJ/SG

REF		
REC25W40U3	5 L	3

OLIO SEMISINTETICO 4 TEMPI

Olio semisintetico per motori a 4 tempi, adatto a motori con elevati RPM e carichi pesanti. Lubrificazione di tutti i componenti del motore, elevate proprietà anticorrosione, antiossidazione e antiusura. Buone proprietà di avvio a freddo.

HUILE SEMI-SYNTHÉTIQUE 4T

Huile semi-synthétique pour des moteurs 4T adapté aux moteurs avec des hauts RPM. Grande capacité anti-corrosion, anti-oxdation et contre l'usure. Propriétés adéquates pour un démarrage à froid. Elle maintient la propreté du moteur et augmente la protection face à la corrosion du à l'environnement salin.



ACEITE SINTÉTICO PARA MOTORES VERADO

REF	R.O. OEM		
RM92-8M0086227U3	92-8M0086227	4 L	3

SYNTHETIC OIL FOR VERADO ENGINES

OLIO SINTETICO PER MOTORI VERADO

HUILE SYNTHÉTIQUE POUR VERADO



ACEITE MOTORES GASOLINA

REF	R.O. OEM		
RM92-8M0086224U3	92-8M0086224	3,8 L	3

GASOLINE ENGINES OIL

OLIO MOTORE BENZINA

HUILE MOTEUR ESSENCE



ACEITE SINTÉTICO TRASMISIONES

Aceite sintético de altas prestaciones. Para colas de transmisión mecánica.

REF	R.O. OEM		
RM92-858064QB1U6	92-858064QB1	1 L	6
RM92-858065QB1U2	92-858065QB1	9,5 L	2

SYNTHETIC DRIVES OIL

High performance synthetic Lower Unit Gear Lube for mechanical drives.

OLIO SINTETICO PER TRASMISSIONE

Olio sintetico di alte prestazioni. Per piedi poppieri a trasmissione meccanica.

HUILE SYNTHÉTIQUE POUR EMBASES

Huile synthétique haute performance. Pour les embases mécanique.

RM92-858064QB1U6



RM92-858065QB1U2



new

Lubricante marino para transmisiones de motores intraborda y fueraborda de los principales fabricantes, que requieren aceites con una calidad API GL 5. Consulte el manual de usuario antes de elegir el lubricante.

GL-5 synthetic oil of the highest quality for marine drives and IPS Oil recommended for the transmission of inboard and outboard engines of the main manufacturers that require API GL 5 quality oils. Read the user manual before choosing a lubricant.

Olio sintetico GL-5 di altissima qualità per s-drive, trasmissioni IPS e riduttori. Olio consigliato per trasmissioni entro bordo e fuoribordo dai principali produttori che richiedono oli di qualità API GL 5. Consultare il manuale d'uso prima di scegliere il lubrificante.

Huile Synthétique recommandé par les principaux fabricants conçu pour des transmissions de moteur inboard et hors-bord qui précisent d'une qualité API GL 5. N'hésitez pas à consulter le manuel d'utilisation avant de choisir votre lubrifiant



QUALITY LEVELS  
API GL-5

REF		
REC80W90U6	1 L	6
REC80W90U3	5 L	3



ACEITES SINTÉTICOS

Aceite sintético de alta calidad. Para colas de transmisión mecánica. Especialmente indicados para los motores de gran cilindrada o de uso frecuente. Reduce el grado de fricción y calentamiento. No se mezcla con el agua. No anula las garantías de los fabricantes.

SYNTHETIC OILS

Lower Unit Gear Lube for mechanical drives. A synthetic gear lube that protects high-performance lower units in extreme operating conditions. Highly recommended for all engines over 100 hp. Will not avoid manufacturers' warranties.

OLIO SINTETICO

Olio sintetico di alta qualità. Per trasmissione meccanica. Indicato specialmente per motori di grande cilindrata o di uso frequente. Riduce il grado di attrito e riscaldamento. Non si mescola con l'acqua. Non annulla la garanzia del produttore.

HUILES SYNTHÉTIQUES

Huile synthétique de haute qualité. Pour les embases mécanique. Particulièrement adapté pour les moteurs de grande cylindrée ou à usage fréquent. Réduit le degré de friction et d'échauffement. Elle ne se mélange pas à l'eau. N'annule pas les garanties du fabricant.

REF		
LUB11564U12	1 L	12
LUB11565	19 L	1



LUB11564U12

LUB11565

ACEITE MINERALES

Para colas de transmisión mecánica. Especialmente indicados para los motores de gran cilindrada o de uso frecuente. Fabricado con aditivos especiales para proveer una máxima durabilidad e inhibidores de la corrosión para una mayor protección contra el óxido y la corrosión.

MINERAL GEAR OILS

Lower Unit Gear Lube for mechanical drives. Lower Unit Gear Lube. Ideal for modern outboard and stern drive lower units. Will not avoid manufacturers' warranties.

OLIO MINERALE

Per piedi poppieri a trasmissione meccanica. Indicato specialmente per motori di grande cilindrata o di uso frequente. Fabricato con additivi speciali per fornire una massima durata e impedire la corrosione per una maggiore protezione contro l'ossidazione e la corrosione.

HUILE MINÉRALE

Pour les embases mécanique. Particulièrement adapté pour les moteurs de grande cylindrée ou à usage fréquent. Fabriqué avec des additifs spéciaux pour offrir une durabilité maximale et des inhibiteurs de corrosion pour une meilleure protection contre la rouille et la corrosion.

REF			
LUB11540U12	280 g	12	
LUB11552U12	1 L	12	
LUB11546		19 L	1



LUB11540U12

LUB11552U12

LUB11546

**KIT ACEITE COLAS**

Kit para cambiar el aceite mineral de las colas OMC, Volvo, Mercruiser, Mercury y Mariner.

REF	Image	Weight
LUB11101		385 g



**LOWER UNIT LUBE KIT**

Includes 2 tubes of high-viscosity lower unit gear lube. For OMC, Volvo, Mercruiser, Mercury & Mariner drives.

**KIT OLIO PIEDI**

Kit per cambiare l'olio minerale dei piedi poppieri OMC, Volvo, Mercruiser, Mercury e Mariner.

**KIT D'HUILE D'EMBASE**

Kit pour changer l'huile minérale des embases OMC, Volvo, Mercruiser, Mercury et Mariner etc...



**GRASA MARINA. INSOLUBLE AL AGUA**

Grasa marina semisintética con base de litio-calcio, de cuerpo espeso y color azul. 100% insoluble al agua, especialmente formulada para todo tipo de aplicaciones náuticas incluso prensaestopas y hélices plegables, gracias a la buena adhesión al metal.

REF	Image	Weight	Quantity
REGREU1		5 kg	1
REGREU12		400 g	12



**MARINE GREASE. NON-WATER-SOLUBLE**

Semi-synthetic marine grease with a lithium and calcium base, thick and blue. 100% non-water-soluble, especially formulated for all nautical uses, including cable glands and foldable propellers, thanks to good adherence to metal.

**GRASSO MARINO. INSOLUBILE IN ACQUA**

Grasso marino semisintetico a base di litio-calcio, di aspetto denso e di colore azzurro. 100% insolubile in acqua, specificamente formulato per applicazioni nautiche di tutti i tipi, compresi premistoppa ed eliche pieghevoli, grazie all'alta aderenza ai metalli.

**GRAISSE MARINE INSOLUBLE A L'EAU**

Graisse marine semi-synthétique à base de lithium-calcium, épais et bleu. 100% insoluble avec l'eau, spécialement conçu pour tout type d'application nautiques, même pour des presse-étoupes et les hélices pliables grâce à sa propriété d'adhésion au métal.



new



Lubricante insoluble al agua, ideal para aplicaciones marinas. Excelente protección contra fricciones, óxido y corrosión.

Special calcium sulfonate complex, water insoluble formula ideal for marine applications. Provides excellent corrosion protection under severe conditions caused by salt water and air.

Lubrificante insolubile all'acqua, ideale per applicazioni marine. Eccellente protezione contro l'attrito, l'ossido e la corrosione.

Lubrifiant insoluble dans l'eau, idéal pour les applications marines. Excellente protection contre le frottement, la rouille et la corrosion.

REF	Image	Weight	Image	Quantity
LUB11400		85g		4
LUB11402		400 g		1
LUB11406		280 g		1
LUB11407		13,5 kg		1
LUB11404		450 g		1



LUB11400



LUB11402



LUB11406



LUB11407



LUB11404

GRASA DE LITIO	LITHIUM GREASE	GRASSO AL LITIO	GRAISSE AU LITHIUM
----------------	----------------	-----------------	--------------------

Grasa de litio con Teflón. Color blanco.

Heavy duty white lithium grease with Teflon.

Grasso al litio con Teflón. Colore bianco.

Graisse au lithium avec téflon. Couleur blanche.

REF  
LUB11363 350 ml



ACEITE TRIM / TILT	POWER TRIM & TILT FLUID	OLIO TRIM / TILT	HUILE DE TRIM/TILT
--------------------	-------------------------	------------------	--------------------

Proporciona la viscosidad y lubricación necesaria para asegurar el perfecto funcionamiento de la bomba alargando la vida de los retenes y juntas.

Formulated to provide viscosity and lubricity necessary to ensure proper pump performance and seal life.

Fornisce la viscosità e la lubrificazione necessaria per assicurare il perfetto funzionamento della pompa allungando la vita delle guarnizioni.

Elle fournit la viscosité et la lubrification nécessaires pour assurer le fonctionnement parfait de la pompe, prolonge la durée de vie des joints, joints.

REF  
LUB11578U12 280 g 12



ACCESORIOS Y HERRAMIENTAS DE INSTALACIÓN	ACCESSORIES AND INSTALATION TOOLS	ACCESSORI E ATTREZZI ISTALAZIONE	ACCESSOIRES ET OUTILS D'INSTALLATION
------------------------------------------	-----------------------------------	----------------------------------	--------------------------------------

**KIT PISTOLA + GRASA**

**MIDGET GREASE GUN KIT**

**KIT PISTOLA + GRASSO**

**KIT PISTOLET + GRAISSE**

Kit compuesto de una pistola pequeña y muy versátil que permite la salida del tubo conector frontal o superior. Presión máxima 300 k/cm<sup>2</sup>. Incluye un bloqueador para mantener el cartucho en posición y tubo de salida de 14 cm. Admite cartuchos de 3 onzas (85 g) o grasa a granel.

Marine corrosion control lubrication kit. Small, versatile gun allows for front or top pipe placement. Barrel takes 3 oz grease cartridge or can be bulk loaded. Develops up to 4,500 psi.

Kit composto da una pistola piccola e molto versatile che permette l'uscita del grasso dal tubo frontale o superiore. Pressione massima 300 k/cm<sup>2</sup>. Include un blocco per tenere la cartuccia in posizione, il tubo è da 14 cm. Utilizza cartuccia da 85 gr o grasso sfuso.

Kit composé d'un petit pistolet très polyvalent qui permet la sortie du tube de connexion avant ou supérieur. Pression maximale 300 k / cm<sup>2</sup>. Il comprend un bloqueur pour maintenir la cartouche en position et un tube de sortie de 14 cm. Prend en charge des cartouches de 3 oz (85 g) ou de la graisse en vrac.

REF  
RECT30190



BOMBA DEPÓSITO	GREASECASE FILLER	POMPA OLIO	POMPE DE REMPLISSAGE															
Para llenado de colas. Con válvula de ventilación para evitar derrames.	With check valve venting system to avoid overflow	Per mettere l'olio nei piedi poppier. Con valvola di sfianto per evitare fuoriuscite.	Pour le remplissage des embases. Avec valve de ventilation pour éviter les déversements.															
<table border="1"> <thead> <tr> <th>REF</th> <th>Bomba depósito</th> <th>Greasecase filler</th> <th>Pompa olio</th> <th>Pompe de remplissage</th> </tr> </thead> <tbody> <tr> <td>REC55133GF</td> <td>Adaptador métrico (excepto Suzuki)</td> <td>Metric adaptor (excl. Suzuki)</td> <td>Adattatore metrico (eccetto Suzuki)</td> <td>Adaptateur métrique (sauf Suzuki)</td> </tr> <tr> <td>REC55133S</td> <td>Adaptador para Suzuki</td> <td>Adaptor for Suzuki</td> <td>Adattatore per Suzuki</td> <td>Adaptateur Suzuki</td> </tr> </tbody> </table>				REF	Bomba depósito	Greasecase filler	Pompa olio	Pompe de remplissage	REC55133GF	Adaptador métrico (excepto Suzuki)	Metric adaptor (excl. Suzuki)	Adattatore metrico (eccetto Suzuki)	Adaptateur métrique (sauf Suzuki)	REC55133S	Adaptador para Suzuki	Adaptor for Suzuki	Adattatore per Suzuki	Adaptateur Suzuki
REF	Bomba depósito	Greasecase filler	Pompa olio	Pompe de remplissage														
REC55133GF	Adaptador métrico (excepto Suzuki)	Metric adaptor (excl. Suzuki)	Adattatore metrico (eccetto Suzuki)	Adaptateur métrique (sauf Suzuki)														
REC55133S	Adaptador para Suzuki	Adaptor for Suzuki	Adattatore per Suzuki	Adaptateur Suzuki														

PISTOLA DE GRASA	LEVER GREASE GUN	PISTOLE GRASSO	POMPE A GRAISSE															
Incluye manguera curvada y conector standard. Ideal para engrasar crucetas, cables de dirección, cañas de motor fuerborda, piñones y cualquier otra parte del motor que precise engrase. Con visor para reserva. Se recarga sin necesidad de tubo.	Standard Lever grease gun. Includes curved pipe and std coupler. Ideal for greasing spreaders, steering wires, rods outboard engine, gear bearing and other parts of the engine that needs greasing. With Viewer for reservation. Will reload without tube.	Include tubo flessibile curvo e connettore standard. Ideale per ingrassare cavi dello sterzo, barre del motore fuorbordo, ingranaggi e qualsiasi altra parte del motore che abbia bisogno di lubrificazione. Con visora per la prenotazione. Si ricarica senza tubo.	Comprend un tuyau incurvé et un connecteur standard. Idéal pour graisser les traverses, les câbles de direction, les tiges de moteur entraîné, les pignons et toute autre partie du moteur qui a besoin d'être graissée. Avec viseur pour réservation. Il se recharge sans tube.															
<table border="1"> <thead> <tr> <th>REF</th> <th>600 cc</th> <th>16000 psi</th> </tr> </thead> <tbody> <tr> <td>RECT30201</td> <td>Manguera 30 cm</td> <td></td> </tr> <tr> <td>LUB10212</td> <td>Hose 30 cm</td> <td></td> </tr> <tr> <td></td> <td>Tubo 30 cm</td> <td></td> </tr> <tr> <td></td> <td>Tuyau 30 cm</td> <td></td> </tr> </tbody> </table>		REF	600 cc	16000 psi	RECT30201	Manguera 30 cm		LUB10212	Hose 30 cm			Tubo 30 cm			Tuyau 30 cm			
REF	600 cc	16000 psi																
RECT30201	Manguera 30 cm																	
LUB10212	Hose 30 cm																	
	Tubo 30 cm																	
	Tuyau 30 cm																	

Pistola para tubos de grasa. Incluye manguera flexible de 14 cm y adaptador standard.	All purpose gun operates handy, squeeze tubes. Includes 2-11/16" pipe and plastic push-type coupler.	Pistola per tubi di grasso. Include tubo flessibile da 14 cm e adattatore standard.	Pistolet pour tubes de graisse. Comprend un tuyau flexible de 14 cm et un adaptateur standard.		
<table border="1"> <thead> <tr> <th>REF</th> </tr> </thead> <tbody> <tr> <td>LUB30197</td> </tr> </tbody> </table>	REF	LUB30197			
REF					
LUB30197					

PISTOLA DE ACEITE	BOTTLE GREASE PUMP	PISTOLA OLIO	POMPE POUR HUILE		
Pistola para acoplar en los envases de botella de 1 litro de LUB11552 y LUB11564. Se suministra con kit de adaptación con válvula anti-retorno.	Lower unit quart pump. Complete with metal threaded filler fitting.	Pistola da accoppiare a bottiglie da 1 L LUB11552 e LUB11564. Si vende con kit di accoppiamento con valvola anti-ritorno.	Pompe pour les bidons de 1 litre de LUB11552 et LUB11564. Livré avec kit d'adaptation avec clapet anti-retour.		
<table border="1"> <thead> <tr> <th>REF</th> </tr> </thead> <tbody> <tr> <td>REC55005</td> </tr> </tbody> </table>	REF	REC55005			
REF					
REC55005					



**KI ENGRASADORES METRICOS**

**METRIC GREASE FITTINGS**

**KIT LUBRIFICATORI METRICI**

**KIT GRAISSEURS METRIQUES**

REF	0°	45°	90°	
LUB11957	4	2	2	M6x1

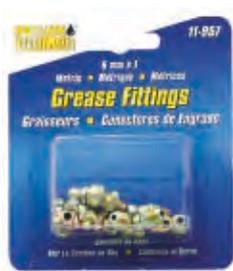

REF	90°	
RECT11958	4	M6x1



**OREJERAS REDONDAS**

**MOTOR FLUSHER ROUND**

**CUFFIE LAVAGGIO ROTONDE**

**OREILLES RONDES**

Tomas de agua para refrigeración de motores fueraborda y colas intra-fueraborda.

For use on most outboards and inboard/outboards engines with side water inlets.

Cuffie lavaggio per motori entro-fuoribordo e fuoribordo.

Sorties d'eau pour le refroidissement du moteur hors-bord et in-bord.



REF	
GS30350	1



USO PROFESIONAL  
PROFESSIONAL  
USO PROFESSIONALE  
USAGE PROFESSIONNEL

REF	
GS30351	1



**OREJERAS CUADRADAS**

**MOTOR FLUSHER SQUARE**

**CUFFIE LAVAGGIO QUADRATE**

**OREILLES CARRÉES**

Tomas de agua para refrigeración de motores fueraborda y colas intra-fueraborda.

For use on most outboards and inboard/outboards engines with side water inlets.

Cuffie lavaggio per motori entro-fuoribordo e fuoribordo.

Sorties d'eau pour le refroidissement du moteur hors-bord et in-bord.



REF	
GS30352	1



USO PROFESIONAL  
PROFESSIONAL  
USO PROFESSIONALE  
USAGE PROFESSIONNEL

REF	
GS30353	1



**EXTRACTOR IMPULSORES**

**IMPELLER REMOVAL**

**ESTRATTORE GIRANTE**

**EXTRACTEUR DE TURBINE**

Extractor para impulsores flexibles de bombas, motores fueraborda e interiores.

Flexible impeller removal tool, suitable for all marine flexible impellers of water pumps, outboard and inboard engines.

Estrattore per giranti di pompe di motori fuoribordo e entrobordo.

Extracteur pour turbines flexibles, moteurs hors-bord et in-bord.

REF	
GS20198	∅ 65 mm 2-1/2"
GS20199	∅ 77 - 127 mm ∅ 3" - 5"



**EXTRACTOR COJINETES Y HÉLICES**

Extractor de cojinetes y hélices, con patas. Para todos los cojinetes Mercruiser y la mayoría de las hélices.

REF  
REC90095

**PROP AND BEARING PULLER**

Prop and bearing carrier puller. Capacity: 5 Tons (Min). For Mercruiser All Style Bearing Carrier and Most Props.

**ESTRATTORE CUSCINETTI E ELICHE**

Estrattore cuscinetti e eliche. Per tutti i cuscinetti Mercruiser e la maggior parte delle eliche.



Para hélices y cojinetes antiguos  
For prop and old style bearing carrier.  
Per eliche e cuscinetti vecchi.  
Pour hélices et roulements anciens



Para cojinetes modernos  
For new style bearing carrier.  
Per cuscinetti moderni.  
Pour roulements modernes

**EXTRACTEUR DE ROULEMENT ET D'HELICE**

Extracteur de roulements et hélices. Pour tous les roulements Mercruiser et la plupart des hélices.



**FONENDOSCOPIO**

Instrumento de precisión, resistente a golpes, detecta fácilmente ruidos en motores, cojinetes y otras partes móviles. Incluye varilla de test, trompeta y auriculares.

REF  
REC91-00003

**SPARK GAP TESTER**

Sensitive, shockproof instrument, easily locates noises in engines bearings and other moving parts. Includes aluminium alloy probe / needle, surgical PVC, rubber trumpet and plastic earphones.

**FONENDOSCOPIO**

Strumento di precisione, resistente a colpi, rileva facilmente rumori nel motore, nei cuscinetti e altre parti mobili. Include la tromba e gli auricolari.

**PHONENDOSCOPE**

Instrument de précision, résistant aux chocs, détecte facilement le bruit dans les moteurs, roulements et autres pièces mobiles. Comprend une tige d'essai, une trompette et des écouteurs.



**EXTRACTOR PIÑONES Y COJINETES**

REF	PIÑONES BEARINGS PIGNONE PIGNON
REC91-00001	30-50 mm / 1 1/4" ~ 2 1/4"
REC91-00002	50-75 mm / 2 1/4" ~ 3 1/2"
REC91-37241	75-105 mm / 3" ~ 4 1/2"

**UNIVERSAL PULLER PLATE**

**ESTRATTORE PIGNONE E CUSCINETTI**

**EXTRACTEUR DE PIGNON ET PALIER**



**LLAVE DINAMOMÉTRICA**

Con escala en: 20-150 pie/lb y 33.9 - 210 N.m  
Incrementos cada 1 pie/lb y 1,4 N.m  
Dado de conexión: 1/2"

REF  
CRA944595 518 x 35 x 40 mm

**TORQUE WRENCH**

Scale in: 20-150 ft.-lbs. 33.9 - 210 N.m  
Increases each 1 ft.-lbs. & 1,4 N.m  
1/2" drive.

**CHIAVE DINAMOMETRICA**

Con scala da: 20-150 piedi/lb e 33.9 - 210 N.m  
Incremento di 1 pie/lb e 1,4 N.m  
Dado attacco: 1/2"

**CLÉ DYNAMOMÉTRIQUE**

Avec échelle à: 20-150 pieds/livres et 33.9 - 210 N.m  
Incréments tous les 1 pied/livre et 1,4 N.m  
Embout de connexion: 1/2"



**LLAVE FRENO VOLANTE PARA FUERABORDAS**

REF  
REC5515100

**FLYWHEEL HOLDER PER OUTBOARDS**

**CHIAVE FRENO VOLANTE PER FUORIBORDO**

**CLÉ FREIN DE VOLANT POUR HORS-BORD**



CHISPÓMETRO	SPARK GAP TESTER	SCINTILLOMETRO	CONTRÔLEUR D'ALLUMAGE						
Se puede comprobar la chispa con el motor en funcionamiento.	Good for checking spark on running engine.	Si può provare la scintilla con il motore in funzione.	L'étincelle peut être vérifiée avec le moteur en marche.						
<table border="1"> <thead> <tr> <th>REF</th> <th>CYL</th> </tr> </thead> <tbody> <tr> <td>REC5119766</td> <td>8</td> </tr> <tr> <td>REC004</td> <td>1</td> </tr> </tbody> </table>	REF	CYL	REC5119766	8	REC004	1	 <p>REC5119766</p>	 <p>REC004</p>	
REF	CYL								
REC5119766	8								
REC004	1								

KIT EXTRACTOR DE POLEAS	PULLER TOOL KIT	KIT ESTRATTORE PULEGGE	KIT EXTRACTEUR DE POULIE		
Extractor de polea contrapesos. Contiene 5 juegos de tornillos de diferentes medidas.	Harmonic ballancer puller. 5 sets of screws are provided.	Estrattore di pulegge. Contiene 5 kit di viti di differenti misure.	Extracteur de poulie. Il contient 5 jeux de vis de différentes tailles.		
<table border="1"> <thead> <tr> <th>REF</th> </tr> </thead> <tbody> <tr> <td>SSP4600</td> </tr> </tbody> </table>	REF	SSP4600			
REF					
SSP4600					

<p>Kit para extraer e instalar poleas. Para uso en todos los motores Ford, GM y Chrysler. También puede utilizarse para volantes de dirección y poleas en general. Esfuerzo máximo recomendado: 20 kg.</p>	<p>Harmonic ballancer puller and installation tool kit. Use on all Ford, GM &amp; Chrysler engines. Heavy duty tool. Can also be used for steering wheels and pulleys</p>	<p>Kit per estrarre e installare pulegge in tutti i motori Ford, GM e Chrysler. Si può utilizzare per volani di direzione e pulegge in generale. Carico massimo: 20 kg.</p>	<p>Kit pour extraire et installer les poulies. A utiliser sur tous les moteurs Ford, GM et Chrysler. Il peut également être utilisé pour les volants et les poulies en général. Effort maximal recommandé: 20 kg.</p>		
<table border="1"> <thead> <tr> <th>REF</th> </tr> </thead> <tbody> <tr> <td>SSPHBP100K</td> </tr> </tbody> </table>	REF	SSPHBP100K			
REF					
SSPHBP100K					

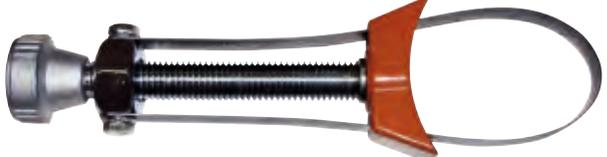
EXTRACTOR FILTROS	OIL FILTER WRENCH	ESTRATTORE FILTRI	CLÉ À FILTRE				
<table border="1"> <thead> <tr> <th>REF</th> <th>PARA FILTROS FILTERS PER FILTRI POUR FILTRES</th> </tr> </thead> <tbody> <tr> <td>REC70720</td> <td>65 - 110 mm</td> </tr> </tbody> </table>	REF	PARA FILTROS FILTERS PER FILTRI POUR FILTRES	REC70720	65 - 110 mm			
REF	PARA FILTROS FILTERS PER FILTRI POUR FILTRES						
REC70720	65 - 110 mm						

KIT LLAVE HÉLICE	PROP WRENCH KIT	KIT CHIAVE ELICHA	KIT CLÉ À HÉLICE						
<table border="1"> <thead> <tr> <th>REF</th> <th>R.O. OEM</th> <th></th> </tr> </thead> <tbody> <tr> <td>REC91-859046Q4</td> <td>MC 91-859046Q4 HONDA 89-89206-ZW7-000AH</td> <td>Mercury Mariner Force V4 &amp; V6 Mercuriser Honda BF75-BF130</td> </tr> </tbody> </table>	REF	R.O. OEM		REC91-859046Q4	MC 91-859046Q4 HONDA 89-89206-ZW7-000AH	Mercury Mariner Force V4 & V6 Mercuriser Honda BF75-BF130			
REF	R.O. OEM								
REC91-859046Q4	MC 91-859046Q4 HONDA 89-89206-ZW7-000AH	Mercury Mariner Force V4 & V6 Mercuriser Honda BF75-BF130							



HERRAMIENTA AROS-PISTONES	RING COMPRESOR KIT	KIT FASCE-PISTONI	OUTIL SEGMENTS ET PISTONS
<p>Kit herramientas para la instalación de aros y pistones. Incluye 6 bandas de 7 a 11 cm.</p> <p>REF SSP4213</p>	<p>Ring compressor kit for pistons. Includes 6 band 2-7/8" - 4-3/8"</p>	<p>Kit per montare le fasce dei pistoni. Include 6 bande da 7 a 11 cm.</p>	<p>Kit d'outils pour l'installation des segments et pistons. Il comprend 6 colliers de 7 à 11 cm.</p>
			

REF	PARA AROS Y PISTONES RING COMPRESOR PISTONS PER FASCE E PISTONI POUR SEGMENTS ET PISTONS	
SSP4206	127 mm Ø / 2-1/8" - 5" Ø	
SSP4207	178 mm Ø / 3-1/2" - 7" Ø	

KIT ALARGADOR CABLE BUJIAS	EXTENSION WIRES	KIT PROLUNGA CAVI CANDELE	KIT EXTENSION DE FAISCEAU DE BOUGIE									
<table border="1"> <thead> <tr> <th>REF</th> <th></th> <th></th> </tr> </thead> <tbody> <tr> <td>REC5119902</td> <td>18 cm</td> <td>4</td> </tr> <tr> <td>REC5119903</td> <td>60 cm</td> <td>4</td> </tr> </tbody> </table>	REF			REC5119902	18 cm	4	REC5119903	60 cm	4			
REF												
REC5119902	18 cm	4										
REC5119903	60 cm	4										
												
	REC5119902	REC5119903										

PULIDORA DE CILINDROS	ENGINE CYLINDER HONE	PULITRICE CILINDRI	RODOIR DE CYLINDRE
<p>Para pulir los cilindros de los bloques. Garantizada de por vida.</p> <p>REF CRA904633</p>	<p>Quickly removes the glaze from engine cylinder walls before installing new piston rings. Lifetime warranty.</p>	<p>Per pulire i cilindri dei blocchi. Garantita a vita.</p>	<p>Poli les cylindres des blocs moteur. Garanti à vie.</p>
			
<p>KIT DE 3 PIEDRAS PARA RECAMBIO DE LA PULIDORA 3 PIECES SPARE PART FOR HONE KIT DA 3 SPAZZOLE DI RICAMBIO PER LA PULITRICE KIT DE 3 PIERRES DE REMPLACEMENT POUR LE RODOIR</p> <p>REF CRA946331</p>			

VACUÓMETRO DOBLE FUNCIÓN	PRESSURE / VACUUM TESTER	VACUOMETRO DOPPIA FUNZIONE	VACUOMÈTRE DOUBLE FONCTION
Presión y vacío. Ideal para comprobar las colas.	Combination unit that does pressure and vacuum testing in one units. Recommended to test drives.	Pressione e sottovuoto. Ideale per il controllo dei piedi.	Pression et vide. Idéal pour vérifier les embases.
<p>REF</p> <p>REC55134</p>			

COMPRESÍMETRO	COMPRESSION TESTER KIT	MANOMETRO	COMPRESSIOMÈTRE
Para motores gasolina con bases GM o Ford.	For gas engines with GM or Ford base.	Per motori benzina con base GM e Ford.	Pour les moteurs à essence bases GM ou Ford.
<p>REF</p> <p>CRA902171</p>			

PISTOLA PUESTA A PUNTO	TIMING LIGHT	PISTOLA MESSA A PUNTO	LAMPE STROBOSCOPIQUE
Con regulador de avance.	0-60 advance scale.	Con regolatore avanzamento.	Avec régulateur d'avance.
<p>REF</p> <p>CRA921023</p>			

INTERRUPTOR ARRANQUE	REMOTE STARTER	INTERRUTTORE AVVIAMENTO	INTERRUPTEUR DE DÉMARRAGE A DISTANCE
<p>REF</p> <p>CRA902175</p> 			

### MULTITESTER DIGITAL

Multímetro ecológico autorango con símbolos de función en pantalla, energía mediante generador manual incorporado, también puede funcionar con batería. Incorpora manivela plegable para cargar el multímetro, 20 segundos de manivela generan suficiente carga para trabajar 10 min (sin batería).  
Equipo recomendado para mantenimiento del sector náutico.  
Multímetro digital de 3 5/6 dig. (6000)  
Medidas de tensión CC / CA  
Medidas de corriente CC / CA  
Medidas de resistencia / continuidad  
Medidas de capacidades / frecuencias  
Medidas / Prueba de diodos  
Detecta tensión AC o DC automáticamente  
Retención de lectura Hold  
Selección de rango: auto y manual  
Función de autoapagado (3min)  
Pantalla grande 46x45mm

### DIGITAL MULTITESTER

Ecological autoranging multimeter with function panel on screen, hand power generator, it can also run on battery. Includes folding crank to charge the meter, 20-second crank generate enough charge to work 10 min (without battery).  
Recommended equipment for maintenance, nautical sector.  
Digital Multimeter 3 5/6 Digit. (6000)  
Measures voltage DC / AC  
Measures DC / AC current  
Measures resistance / continuity  
Measures capacity / frequency  
Measures / Diode Test  
Detects AC or DC voltage automatically  
Hold reading retention  
Range Selection: auto and manual  
Auto Off function (3min)  
Large display 46x45mm

### MULTITESTER DIGITALE

Multitester ecologico con simboli di funzione nello schermo, energia mediante generatore manuale incorporato, funziona anche con batteria.  
Manovella piegabile incorporata, per ricaricare il multitester, 20 secondi di manovella. In genere per lavorare è sufficiente caricarlo per 10 minuti senza batteria.  
Strumento raccomandato per utilizzo nel settore nautico.  
Multitester digitale 3 5/6 dig. (6000)  
Misure di tensione CC / CA  
Misure di corrente CC / CA  
Misure di resistenza / continuità  
Misure di capacità / frequenza  
Misure / Prova di diodi  
Rileva la tensione AC o DC automaticamente  
Ritenzione di lettura Hold  
Selezione di gamma: auto e manuale  
Accensione automatica (3min)  
Display grande 46x45mm

### MULTIMÈTRE DIGITAL

Multimètre écologique avec symboles de fonction sur l'écran, alimentation au moyen d'un générateur manuel intégré, il peut également fonctionner avec une batterie. Il intègre une manivelle pliante pour charger le multimètre, 20 secondes de manivelle génèrent suffisamment de charge pour fonctionner 10 min (sans batterie).  
Matériel recommandé pour la maintenance, secteur nautique.  
Multimètre digital 3 5/6 chiffres. (6000)  
Mesures de tension DC / AC  
Mesures de courant DC / AC  
Mesures de résistance / continuité  
Mesures de capacité / fréquence  
Mesures / Test de diode  
Détecte automatiquement la tension alternative ou continue  
Maintien la rétention de lecture  
Sélection de gamme: automatique et manuelle  
Fonction d'arrêt automatique (3min)  
Grand écran 46x45mm



REF  
TEC145

### VACUÓMETRO SINCRONIZADOR

Vacuómetro, sincronizador de admisión, analizador dinámico de fugas y tacómetro. Impermeable e insumergible con una funda especial.  
Posee mayor estabilidad que los indicadores analógicos o que cualquier otro sistema. Se autorregula a los cambios de presión barométrica.  
Alimentación con corriente continua de 12 V, se puede utilizar con cualquier batería de embarcación o vehículo o con un adaptador de entrada a la red (230V/12V).  
Indicadores LED de batería descargada y de alimentación no adecuada.  
Contiene: Cable y pinzas por alimentación 12V, tubos de santoprene de conexión, 2 juegos de adaptadores flexi-rígidos, caja de almacenaje.

### VACUUMMATE ALLWEATHER

Vacuomate allweather, 4 x carb/throttle valve.  
Shock resistant composite-moulded polyurethane and polycarbonate casing for maximum strength and resilience.  
Self-calibrates for barometric changes.  
Solid state sensors are drop proof. It has internal rechargeable 1,5Ah 7,2V NiMH batteries providing up to 6 hours autonomy. Battery power is conserved by auto-switch-off 5 minutes after last being used and LEDs use full power only when measurements are taken.  
Kit includes custom travel case, battery cord-set, T-connector & 2 full sets of unique flexi-rigid.

### VACUOMETRO

Vacuometro, sincronizzatore d'aspirazione, analizzatore dinamico di fughe e tachimetro.  
Impermeabile e immergibile con una custodia speciale.  
Possiede maggiore sensibilità degli indicatori analogici o con altri sistemi.  
Si autoregola al cambio di pressione barometrica.  
Alimentazione con corrente continua da 12 V, si può utilizzare con qualsiasi batteria per imbarcazioni, veicoli e con un adattatore di entrata da 230V/12V.  
Indicatore LED di batteria scarica e di alimentazione non corretta. Contiene: Cavi e pinze per alimentazione 12V, tubi di santoprene di connesione, 2 adattatori flexi-rigidi, scatola per conservare l'attrezzo.

### VACUOMETRE SYNCHRONISEUR

VacuomMate affiche la pression d'admission individuelle de 4 carburateurs séparés (ou boîtier papillons à injection de carburant). Imperméable et insumersible avec une housse spéciale.  
Il a une plus grande stabilité que les indicateurs analogiques ou tout autre système. Il autorégule les changements de pression barométrique.  
Alimentation 12 V DC, utilisable avec n'importe quelle batterie de bateau ou de véhicule ou avec un adaptateur secteur (230V/12V).  
Indicateurs LED de batterie déchargée et de puissance insuffisante.  
Contient: câble d'alimentation 12V et pinces, tubes de connexion, 2 jeux d'adaptateurs flexi-rigides, boîte de rangement.



REF  
TCMVRM5

### PINZA AMPERIMÉTRICA

Tenaza autorango y multifunción para AC y DC.  
Diámetro maxilar: 30 mm  
Display de 3 3/4 dígitos. Máx. 3999.  
Realiza medidas en: AC/DC: 40A/400A  
Precisión: +/- (1,9% + 5 d. en AC)  
Ancho de banda: 50Hz - 500Hz (AC)  
Resolución: AC/DC 10mA. 100mV.  
Resistencia: 400 Ohms.

### AMPERIC NIPPER

Iron autoranging and multifunction for AC and DC.  
Jaw diameter: 30 mm  
Display of 3 3/4 digit. Max. 3999.  
Measurements in: AC/DC current: 40A/400A  
Precision: +/- (1,9% + 5 d. en AC)  
Precision: +/- (2,5% + 10 d. en DC)  
Bandwidth: 50 Hz - 500 Hz (AC)  
Resolution: AC/DC 10mA. 100mV.  
Resistance: 400 Ohms.

### PINZA AMPEROMETRICA

Pinza multifunzione per AC e DC.  
Diámetro max: 30 mm.  
Display da 3 3/4 digitale. Máx. 3999.  
Può realizzare misurazioni in:  
Corrente AC/DC: 40A/400A.  
Precisione: +/- (1,9% + 5 d. en AC)  
Precisione: +/- (2,5% + 10 d. en DC)  
Banda larga: 50Hz - 500Hz (AC)  
Risoluzione: AC/DC 10mA. 100mV.  
Resistenza: 400 Ohms.

### PINCE AMPÈREMÉTRIQUE

Pince ampèremétrique multifonction pour AC et DC.  
Diamètre maxi: 30 mm  
Affichage de 3 3/4 chiffres. Max. 3999  
Effectue des mesures en: AC / DC: 40A / 400A  
Précision: +/- (1,9% + 5 jours en CA)  
Précision: +/- (2,5% + 10 d. En DC)  
Bande passante: 50 Hz - 500 Hz (AC)  
Résolution: AC / DC 10mA. 100mV  
Résistance: 400 Ohms



REF  
TEC218

TERMÓMETRO MULTIFUNCIONAL	INFRARED THERMOMETER	TERMOMETRO MULTIFUNZIONALE	THERMOMÈTRE MULTIFONCTIONNEL
<p>Termómetro multifunción digital, por rayos infrarrojos. Emisividad fija: 0,95 Rango: -20°C + 320°C. Lectura en grados centígrados y farenheit. Precisión +/- 2%. Resolución: 1°C Distancia óptima de medida: de 6 a 60 cm. Retención de la última lectura. Autoapagado.</p>	<p>Multifunction digital infrared thermometer. Fixed emissivity: 0.95 range: - 20 °C + 320 °C. Reading in Celsius and Fahrenheit. Precision +/-2%. Resolution: 1°C Distancia optimal measurement: 6 to 60 cm. Retention of the last reading. Auto Off function.</p>	<p>Termometro multifunzione digitale, a infrarrossi. Misurazione: 0,95 Rango: -20°C + 320°C. Lettura in gradi centigradi e farenheit. Precisione +/- 2%. Risoluzione: 1°C Distanza ottimale di misurazione: da 6 a 60 cm. Memoria dell'ultima lettura. Autospegnimento.</p>	<p>Thermomètre multifonction numérique, par rayons infrarouges. Mesure fixe: 0,95 Plage: -20°C + 320°C. Lecture en degrés Celsius et farenheit. Précision +/- 2%. Résolution: 1°C Distance de mesure optimale: de 6 à 60 cm. Conservation de la dernière lecture. Arrêt automatique</p>



REF  
TECDT8580

ESTABILIZADORES, ELEVADORES Y SEGURIDAD	HYDROFOIL STABILIZER AND SECURITY	STABILIZZATORI, ASCENSORI E SICUREZZA	STABILISATEURS, POWER TRIM-LIFT ET SÉCURITÉ
<p><b>ALETAS ESTABILIZADORAS</b></p> <p>Aletas para acoplar a la placa de cavitación de los motores fueraborda y colas intra-fueraborda. Se obtiene el planeo en menor tiempo. Elimina la cavitación. Mejora la sustentación. Permite mayor estabilidad y ahorro de combustible.</p>	<p><b>HYDROFOIL STABILIZER</b></p> <p>Gives outboards and sterndrives a performance boost. Wipes out cavitation. On plane in less time. Saves fuel. Delivers true stabilization.</p>	<p><b>ALETTE</b></p> <p>Alette da installare nei motori fuoribordo o nei piedi entro-fuoribordo. Planata in minor tempo. Elimina la cavitazione. Migliora la stabilità e riduce il consumo del carburante.</p>	<p><b>HYDROFOIL</b></p> <p>Hydrofoil à fixer sur la plaque de cavitation des moteurs hors-bord et les embases. Le déjaugage met moins de temps. Élimine la cavitation. Permet une plus grande stabilité et économise de carburant.</p>

REF		(cm)
SRXPIJR	2,5 HP - 40 HP	18,50
SRXPI	40 HP +	18,50



SRXPIJR



SRXPI



SRXPI

<p>Diseño de montaje SIN AGUJEROS.</p>	<p>NO-DRILL mounting design.</p>	<p>Montaggio senza fori.</p>	<p>Conception de montage SANS TROUS.</p>
----------------------------------------	----------------------------------	------------------------------	------------------------------------------

REF		(cm)
SRSF	40 HP - 300 HP	18,50









Diseño de montaje SIN AGUJEROS  
Perfil hidrodinámico pulido  
Empuje mejorado  
Canalización del chorro de agua

NO-DRILL mounting design.  
Sleeker hydrodynamic profile.  
Captive Prop-Wash Resulting In  
Improved Thrust  
Fastest Hole Shot

Montaggio senza fori.  
Profilo idrodinamico.  
Spinta migliorata.  
Canalizzazione del getto dell'acqua.

Conception de montage SANS TROUS  
Profil hydrodynamique poli  
Poussée améliorée  
Canalisation par jet d'eau

REF		 (cm)
SRXRIIUR.	2,5 HP - 75 HP	18,50
SRXRIII	75 HP +	18,50



REF		 (cm)
SRPRO1	40 HP - 300 HP	19,55

## POWER TRIM-LIFT

Soporte con kit de Power Trim y Tilt.  
Fabricado en extrusión de aluminio con tornillos de acero inox.  
El motor electro-hidráulico de 3500kg de empuje se encuentra dentro de un contenedor para una mayor protección.

Electric hydraulic Tilt & Trim with a rated thrust of 7800 lbs.  
Made with extruded aluminum and stainless steel fasteners.

Supporto con kit Power Trim e Tilt.  
Fabricato in alluminio con viti in acciaio inox.  
Il motore elettroidraulico ha una spinta da 3500kg e si trova all'interno di un contenitore per una maggior protezione.

Prise en charge avec le kit Power Trim et Tilt.  
Fabriqué en aluminium extrudé avec des vis en acier inoxydable.  
Le moteur de poussée électro-hydraulique de 3500 kg est à l'intérieur d'un boîtier pour une protection supplémentaire.

				CMC13002Q	CMC13001Q
Fuerabordas	Outboards	Fuoribordo	Hors-bord	-130 HP	-130 HP
Recorrido Trim	Trim travel	Escursione Trim	Angle de Trim	20°	20°
Recorrido Tilt	Tilt travel	Escursione Tilt	Angle de Tilt	90°	90°
Alimentación	Operation	Alimentazione	Alimentation	12 V	12 V
Reloj indicador	Lift gauge	Indicatore trim	Indicateur de trim		✓
Separación del espejo	Set-Back from transom	Specchio di poppa	Recul de traverse	152 mm 6"	152 mm 6"



Soporte con kit de Power Trim y Tilt.  
Fabricado en extrusión de aluminio con tornillos de acero inox.  
El motor electro-hidráulico de 3500 kg de empuje se encuentra dentro de un contenedor para una mayor protección.

Electric hydraulic Tilt & Trim with a rated thrust of 7800 lbs.  
Made with extruded aluminum and stainless steel fasteners.

Supporto con kit Power Trim e Tilt.  
Fabricato in alluminio con viti in acciaio inox.  
Il motore elettroidraulico ha una spinta di 3500kg e si trova all'interno di un contenitore per una maggior protezione.

Prise en charge avec le kit Power Trim et Tilt.  
Fabriqué aluminium extrudé avec des vis en acier inoxydable.  
Le moteur électro-hydraulique à une poussée de 3500 kg il est à l'intérieur d'un boîtier pour une protection supplémentaire.

				CMC52100D
Fuerabordas	Outboards	Fuoribordo	Hors-bord	-35 HP
Recorrido Trim	Trim Travel	Escursione Trim	Angle de Trim	84°
Alimentación	Operation	Alimentazione	Alimentation	12 V
Separación del espejo	Set-Back from transom	Specchio di poppa	Recul de traverse	140 mm 5 1/2"



**POWER LIFT**

Soporte con kit elevador vertical.  
Fabricado en extrusión de aluminio con tornillos de acero inox.  
El motor electro-hidráulico de 3500 kg de empuje se encuentra dentro de un contenedor para una mayor protección. Tornillos de 3/4" de acero inoxidable, con tuercas de aleación de aluminio y bronce resistentes a los choques y corrosión.

Electric hydraulic power lift transom jack with a rated thrust of 7800 lbs.  
Made of 1/2" 6061 T6 alloy aluminum extrusions and stainless steel fasteners.  
Totally waterproof electro-hydraulic power lift transom jack with a rated thrust of 7800 lbs.

Supporto con kit elevatore verticale.  
Fabricato in alluminio con viti in acciaio inox.  
Il motore elettroidraulico ha una spinta da 3500kg e si trova all'interno di un contenitore per una maggior protezione. Viti da 3/4" in acciaio inox, con dadi in alluminio e bronzo resistenti alla corrosione.

Support avec kit de levage vertical.  
Fabriqué en aluminium extrudé avec des vis en acier inoxydable.  
Le moteur électro-hydraulique à poussée de 3500 kg est à l'intérieur d'un boîtier pour une protection supplémentaire. Vis 3/4" en acier inoxydable, avec écrous en alliage d'aluminium et de bronze résistant aux chocs et à la corrosion.

				CMC65001Q
Fuerabordas	Outboards	Fuoribordo	Hors-bord	V6
Recorrido vertical	Vertical travel	Lavoro verticale	Relevage vertical	125 mm / 5"
Alimentación	Operation	Alimentazione	Alimentation	12V
Dimensiones	Dimensions	Dimensioni	Les dimensions	460 x 420 mm 18 <sup>1/8"</sup> x 16 <sup>1/2"</sup>
Reloj indicador	Lift gauge	Indicatore trim	Indicateur de Trim	✓
Separación del espejo	Set-Back from transom	Specchio di poppa	Recul de traverse	140 mm / 5 <sup>1/2"</sup>



				CMC61001Q
Reloj indicador	Lift gauge	Indicatore trim	Indicateur de Trim	✓
Separación del espejo	Set-Back from transom	Specchio di poppa	Recul de traverse	254 mm / 10"



**V-8  
300 HP**

				CMC65501
Fuerabordas	Outboards	Fuoribordo	Hors-bord	V8 300HP
Reloj indicador	Lift gauge	Indicatore trim	Indicateur de Trim	✓
Separación del espejo	Set-Back from transom	Specchio di poppa	Recul de traverse	140 mm 5-1/2"



Soporte con kit elevador vertical.  
Fabricado en extrusión de aluminio con tornillos de acero inox. de 3/4".

Electric hydraulic power lift transom jack. Made with extruded aluminum and stainless steel fasteners. Totally waterproof.

Supporto con kit elevatore verticale.  
Fabricato in alluminio con viti in acciaio inox da 3/4".

Support avec kit de levage vertical.  
Fabriqué en aluminium extrudé avec des vis en acier inoxydable. 3/4".

				THAHJM-4DP
Fuerabordas	Outboards	Fuoribordo	Hors-bord	75 HP
Recorrido vertical	Vertical travel	Lavoro verticale	Relevage vertical	127 mm / 5"
Alimentación	Operation	Alimentazione	Alimentation	12 V
Reloj indicador	Lift gauge	Indicatore trim	Indicateur de Trim	✓
Separación del espejo	Set-Back from transom	Specchio di poppa	Recul de traverse	37 x 30 cm 14 <sup>5/8"</sup> x 11 <sup>1/2"</sup>



ADAPTADORES. POWER TRIM-LIFT	BACK SPACERS. POWER TRIM-LIFT	ADATTATORI. POWER TRIM-LIFT	ADAPTATEURS POWER TRIM-LIFT
Par de cuñas de 2º inclinación para espejo de popa.	Pair of 2 degrees wedge for the transom.	Piastre per lo specchio di poppa inclinate di 2°	Paire de cales avec 2ème inclinaison pour tableau arrière.
REF CMC20122Q			

Kit de adaptadores para la instalación de motores con palomillas.	Adaptors kit for motors mounted with transom clamps.	Kit per l'installazione di motori con chiusura con galletti.	Kit d'adaptateur pour l'installation du moteur.
REF CMC13022Q			

ADAPTADORES. POWER LIFT	BACK SPACERS. POWER LIFT	ADATTATORI. POWER LIFT	ADAPTATEURS POWER LIFT
Kit de adaptadores para motores de 75 HP.	Clampon motor adapter 75 HP.	Kit adattatori per motori 75 HP	Kit adaptateur pour moteurs 75 CV.
REF THAHJM-CMADP			

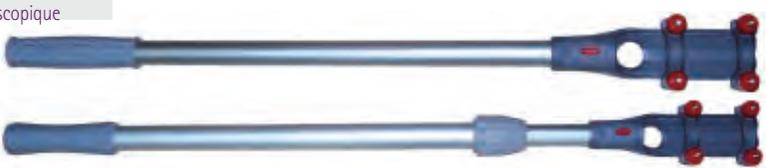
ALARGO BARRA FUERABORDA	EXTENSION HANDLE OUTBOARD	PROLUNGA PER FUORIBORDO	RALLONGE DE BARRE FRANCHE POUR HB
Prolongador de caña con pulsador de paro, para motores fueraborda. Fabricado en aluminio anodizado y maneta de plástico.	With push-button to switch-off the engine. Made of anodized aluminum and plastic handle.	Prolunga per fuoribordo, fabbricato in alluminio anodizzato e impugnatura in plastica.	Rallonge de barre franche avec bouton d'arrêt, pour moteurs hors-bord. Fabriqué en aluminium anodisé et poignée en plastique.
REF GS73135 70 Fijo   Fixed   Fisso   Fixe GS73136 60 - 100 Telescópico   Telescopic   Telescopico   Télescopique			
			

PROTECTOR DE HÉLICES	PROPELLER PROTECTOR	PROTETTORI ELICHE	PROTECTION D'HÉLICE
Mejora el control direccional y aumentando la eficiencia de la hélice. Fabricado en polipropileno de alto impacto. NOTA: Todos los motores «Big Foot» y de arrastre requieren la medida superior. Velocidad Máx: 30 nudos	Manufactured in high impact polypropylene. Better control in directional force. Increase the propeller efficiency. NOTE: All hp's with «Big Foot» and High Thrust applications require next size up. Max. Speed: 30 knots	Migliora il controllo direzionale e aumentando l'efficienza delle eliche. Prodotto in polipropilene di alta qualità. NOTA: Tutti i motori «Big Foot» a alta spinta richiedono la referenza superiore. Velocità Mas.: 30 nodi	Améliore le contrôle directionnel et augmente l'efficacité de l'hélice. Fabriqué en polypropylène résistant aux chocs. REMARQUE: Tous les moteurs "Big Foot" et à forte poussée nécessitent la taille supérieure. Vitesse maximale: 30 nœuds
REF REC5-9.8 REC9.9-20 REC25-35 REC40-65 REC70-100 REC110-230			
	5 - 9 HP 9" 9.9 - 20 HP 9" 25 - 35 HP 11" 40 - 65 HP 13" 70 - 100 HP 14" 110 - 230 HP 16"		
			

**ANTI-ROBO**

Para motores fueraborda. Fabricado en acero inox. de 3 mm con candado de latón con 2 llaves.

**ANTI THEFT**

Manufactured in 3 mm stainless steel pipe. Provided with a padlock in brass with 2 keys.

**ANTI-FURTO**

Per motori fuoribordo. Prodotto in acciaio inox da 3 mm con lucchetto in ottone con 2 chiavi.

**ANTIVOL**

Pour les moteurs hors-bord. Fabriqué en acier inoxydable, 3 mm avec serrure en laiton livrée avec 2 clés.

REF	
GS73138	240 mm
GS73139	320 mm



**ARNÉS FUERABORDA**

Confeccionado con cincha sintética. Una sola medida se ajusta para fuerabordas de 2 a 15 HP.

**HOISTING HARNESS**

Outboard hoisting harness. One size works on virtually all 2 to 15 HP outboards.

**IMBRAGATURA FUORIBORDO**

Confezionato con cinghia sintetica. Una sola misura, si regola per i fuoribordo da 2 a 15 HP.

**HARNAIS HORS-BORD**

Fabriqué dans une sangle synthétique. Une seule taille à ajustée pour les moteurs hors-bord de 2 à 15 CV.

REF
GS73069



**FUNDAS PARA FUERABORDA**

Para motores fueraborda de 2 y 4 tiempos. Confeccionadas en tejido de poliéster de 320 g/m2. Impermeabilizado, transpirable. Costuras reforzadas. Color gris claro.

**OUTBOARD COVERS**

For outboard engines 2 Et 4 stoke. Manufactured in 320 gsm polyester canvas. Weather proof, breathable. Reinforced top stitched seams. Grey color.

**COPERTURA FUORIBORDO**

Per motori fuoribordo di 2 e 4 tempi. Confezionato in tessuto di poliesterre da 320 g/m². Impermeabile, traspirante. Cuciture rinforzate. Colore grigio chiaro.

**HOUSES POUR HORS-BORD**

Pour moteurs hors-bord 2 et 4 temps. Fabriqué en tissu polyester 320g/m2. Imperméable, respirant. Coutures renforcées. Couleur gris clair.

REF		A	B	C
OCEMA0741	-15 hp	32 cm	27 cm	50 cm
OCEMA0742	15-30 hp	40 cm	30 cm	56 cm
OCEMA0743	30-60 hp	49 cm	36 cm	62 cm
OCEMA0744	60-100 hp	53 cm	40 cm	68 cm
OCEMA0745	100-150 hp	58 cm	46 cm	74 cm
OCEMA0746	175-250 hp	60 cm	50 cm	82 cm

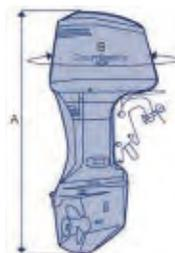

REF		A	B
OCEMA0751	- 6 hp	98 cm	126 cm
OCEMA0752	8 - 15 hp	110 cm	140 cm
OCEMA0753	15 - 20 hp	125 cm	150 cm
OCEMA0754	20 - 30 hp	137 cm	165 cm
OCEMA0755	30 - 60 hp	144 cm	180 cm
OCEMA0756	60 - 100 hp	170 cm	200 cm
OCEMA0757	115 - 150 hp	190 cm	226 cm
OCEMA0758	175 - 250 hp	197 cm	248 cm



# YAMAHA

ES

<b>GUÍA MANTENIMIENTO COLAS Y Y KITS</b>	<b>64</b>	<b>CDI Y CAJAS NEGRAS</b>	<b>117</b>	<b>INTERRUPTOR PANEL SIMPLE (704)</b>	<b>128</b>
<b>SISTEMA DE ALIMENTACIÓN Y FILTRACIÓN</b>	<b>74</b>	<b>DESCONECTORES DE SEGURIDAD</b>	<b>120</b>	<b>INTERRUPTOR POWER TRIM (703)</b>	<b>127</b>
<b>ACEITE</b>	<b>84</b>	<b>KITS</b>	<b>121</b>	<b>MANDO ACELERADOR</b>	<b>134</b>
<b>ACELERADOR</b>	<b>101</b>	<b>LLAVES DE ARRANQUE</b>	<b>113</b>	<b>MANETAS Y FIJACIONES</b>	<b>134</b>
VARILLA DE ACELERADOR	101	LLAVE DOBLE INSTALACIÓN	113	<b>MANDOS DE CONTROL</b>	<b>126</b>
<b>BOMBA DE COMBUSTIBLE EN LÍNEA</b>	<b>74</b>	LLAVE CON CHOQUE	114	CONECTORES DE CABLES	127
ABRAZADERA PARA MANGUERA	75	LLAVE PARA MANDO POPERO	114	MANDO LATERAL <small>PUSH TO TOPEN</small>	126
ADAPTADOR LÍNEA DE COMBUSTIBLE	75	MONTAJE EN MANDO DE CONTROL	113	MANDO LATERAL	127
BOMBA DE COMBUSTIBLE	74	MONTAJE EN PANEL	113	MANDO PARA CONSOLA	127
LÍNEA DE COMBUSTIBLE	74	<b>MOTORES DE ARRANQUE</b>	<b>110</b>	<b>SILENBLOCK</b>	<b>135</b>
MANGUERA DE COMBUSTIBLE	74	CABLE DE MOTOR DE ARRANQUE A BATERÍA	112	<b>SISTEMA DE REFRIGERACIÓN</b>	<b>136</b>
MUELLE TUBO COMBUSTIBLE	75	MUELLE DE ARRANQUE	112	<b>ÁNODOS</b>	<b>158</b>
<b>BOMBA DE COMBUSTIBLE</b>	<b>85</b>	PLATO Y PLACA DE ARRANQUE MANUAL	113	ÁNODO CANADA METAL	158
BOMBA DE COMBUSTIBLE ELÉCTRICA	86	TIRADOR DE ARRANQUE	113	ÁNODO TECNOSEAL	163
BOMBA DE COMBUSTIBLE MECÁNICA	85	TRINQUETE TRACCIÓN PLATO	112	GUÍA DE ÁNODOS	169
JUNTAS VST	88	<b>REGULADORES Y RECTIFICADORES</b>	<b>116</b>	KITS DE ÁNODOS CANADA METAL	162
MEMBRANAS Y JUNTAS	87	<b>SENSORES</b>	<b>102</b>	KITS DE ÁNODOS TECNOSEAL	168
REGULADORES DE PRESIÓN COMBUSTIBLE	89	SENSOR ACCELERACIÓN TS	103	TAPA DE ÁNODO (66M)	168
<b>BOMBA DE INYECCIÓN DE ACEITE</b>	<b>84</b>	SENSOR DE OXÍGENO	103	<b>BOMBA DE AGUA</b>	<b>147</b>
<b>CARBURADOR</b>	<b>91</b>	SENSOR MAP	102	CUERPO BOMBA DE AGUA	147
AGUJA CARBURADOR	98	SENSOR PRESIÓN DE ACEITE	103	GUÍA BOMBAS DE AGUA 4T	154
BOYAS	100	SENSOR TEMPERATURA DEL AGUA	103	GUÍA BOMBAS DE AGUA 2T	155
CARBURADOR COMPLETO	91	SENSOR TPS	102	GUÍA KITS DE BOMBA DE AGUA	153
CONECTOR DE CARBURADOR	100	<b>SOLENOIDE RELÉ</b>	<b>114</b>	KITS DE REPARACIÓN BOMBA DE AGUA	150
ELEMENTO FILTRO DEL CARBURADOR	101	<b>STARTOR</b>	<b>121</b>	TAPA DE LA BOMBA	148
GUÍA CARBURADORES	93	<b>TRIM, TILT &amp; POWER TRIM</b>	<b>122</b>	<b>GUÍA DE IMPULSORES</b>	<b>143</b>
JUNTAS CARBURADORES	94	EXTRACTOR TAPONES DE TRIM	125	KITS DE JUNTAS	144
KITS CARBURADORES	95	DESPIECE PISTÓN TRIM	125	<b>LÍQUIDO INHIBIDOR DE LA CORROSIÓN</b>	<b>136</b>
KIT 3 CARBURADORES	92	INSTALACIÓN ELÉCTRICA	122	<b>TERMOSTATO</b>	<b>136</b>
PASADOR DE BOYA	99	INTERRUPTOR POWER TRIM	122	CUBIERTAS TERMOSTATO	139
TORNILLOS CARBURADOR	98	POWER TRIM COMPLETO	124	GUÍA TERMOSTATO	137
VÁLVULA DE LÁMINAS	99	TRIM COMPLETO BIDIRECCIONAL	122	JUNTAS TAPA DE REFRIGERACIÓN	140
<b>COMPONENTES TANQUE Y CONECTORES</b>	<b>75</b>	<b>VOLANTE DE MOTOR</b>	<b>109</b>	JUNTAS TERMOSTATO	138
CONECTOR DE DEPÓSITO	76	ELÉCTRICO	109	NIPLE	139
FILTRO	76	SIN DIENTES (MANUAL)	109	RESORTE	139
LLAVE DE CIERRE DE DEPÓSITO	76	<b>SISTEMA DE GOBIERNO</b>	<b>126</b>	TERMOSTATO	136
MEDIDOR DE COMBUSTIBLE	76	<b>ARNÉS</b>	<b>128</b>	VÁLVULA ANTIPRESIÓN DE TERMOSTATO	139
PASAMAMPAROS	77	ARNÉS COMPLETO (703)	128	<b>PARTES DEL MOTOR</b>	<b>170</b>
RESORTE DE SEGURIDAD PARA TAPÓN	75	EXTENSIÓN DE ARNÉS (703/704)	128	<b>CIGÜEÑAL 4 TIEMPOS</b>	<b>219</b>
TAPÓN CON RESPIRADERO	75	<b>BRACKET</b>	<b>131</b>	GUÍA CIGÜEÑAL COMPLETO	219
TAPÓN	75	BRACKET BABOR	131	<b>CIGÜEÑAL 2 TIEMPOS</b>	<b>256</b>
<b>FILTRO DE ACEITE</b>	<b>83</b>	BRACKET ESTRIBOR	131	GUÍA BIELAS	260
GUÍA FILTROS DE ACEITE	83	CIRCLIP	132	GUÍA CIGÜEÑAL COMPLETO	256
<b>FILTRO DE COMBUSTIBLE Y ELEMENTOS</b>	<b>77</b>	CONECTOR	132	GUÍA PARTES DE CIGÜEÑAL	256
BRACKET	77	EJE CONECTOR ACELERADOR	132	GUÍA RODAMIENTOS DE MOTOR	257
FILTRO DECANTADOR DE COMBUSTIBLE COMPLETO CON VASO TRASPARENTE	78	ENGRASADOR INOX 316 M6	133	<b>DESPIECE MOTOR DE 4 TIEMPOS</b>	<b>170</b>
FILTRO COMBUSTIBLE MONTAJE EN LÍNEA	80	SOPORTE BARRA DE DIRECCIÓN	131	F2.5	170
FILTRO COMBUSTIBLE SEPARADOR AGUA	77	SOPORTE GIRATORIO	131	F4	174
GUÍA FILTROS DE COMBUSTIBLE	81	SOPORTE INFERIOR	132	F5 • F6	178
GUÍA FILTROS VST	82	RETÉN INFERIOR DEL BRACKET	132	F8	181
FILTRO VST	82	VARILLA DE BASCULACIÓN	132	F9.9	180
LLAVES PARA FILTRO	79	<b>BUJES</b>	<b>133</b>	F13.5 • F15	182
RACOR DE LATÓN	79	<b>COLLAR</b>	<b>133</b>	F20 • F25	190
<b>INYECTORES</b>	<b>89</b>	<b>COMPONENTES 703</b>	<b>129</b>	F30 • F40	196
GUÍA INYECTORES Y SENSORES	90	CABLE DE ACELERADOR	129	F50 • F60	202
INYECTOR	89	CABLES DE CONTROL	130	F70	204
<b>SISTEMA ELÉCTRICO</b>	<b>102</b>	ESPACIADOR	129	F80 • F100 • F115	208
<b>BOBINAS</b>	<b>104</b>	MANETA ACELERADOR	131	F150	210
BOBINA DE CARGA	106	PALANCA ACELERADOR	130	F200 • F225 • F250	212
BOBINA DE IGNICIÓN	104	PLACA CERRADURA SELECTOR	130	F300 • F350	214
BOBINA DE LUZ	104	RUEDA ACCELERACION	130	<b>DESPIECE MOTOR DE 2 TIEMPOS</b>	<b>220</b>
BOBINA DE PULSACIÓN	107	VARILLA DE ENLACE	130	2	220
BOBINA DE T.C.I.	106	<b>EJE DE CAMBIO</b>	<b>134</b>	4 • 5	221
BUJÍAS	108	<b>INTERRUPTORES PARA MANDOS</b>	<b>127</b>	6 • 8	222
		INTERRUPTOR PANEL COMPLETO O DOBLE ESTACIÓN	128	9.9 • 13.5 • 15	226
				25 • 30	228

40	232
48 • 55	238
50 • 60 • 70	240
75 • 85	242
100 • 115 • 130 • 140	244
150 • 175 • 200 • 225	246
<b>GUÍA CORREAS DE DISTRIBUCIÓN</b>	<b>267</b>
<b>JUNTAS DE MOTOR 4 TIEMPOS</b>	<b>215</b>
JUNTAS BASE DE MOTOR	217
JUNTAS DE CULATA	215
KIT JUNTAS DE CULATA	216
GUÍA JUNTAS DE MOTOR	218
<b>JUNTAS DE MOTOR 2 TIEMPOS</b>	<b>248</b>
JUNTAS BASE DE MOTOR	252
JUNTAS DE CULATA	248
JUNTAS DE CULATÍN	255
GUÍA JUNTAS DE MOTOR	254
KITS JUNTAS DE CULATA	249
<b>PISTONES 4 TIEMPOS</b>	<b>219</b>
KITS DE PISTONES	219
<b>PISTONES 2 TIEMPOS</b>	<b>262</b>
GUÍA DE PISTONES Y SEGMENTOS	266
KIT DE PISTONES	262
<b>SISTEMA DE ESCAPE Y ADMISIÓN</b>	<b>268</b>
<b>SISTEMA DE ADMISIÓN</b>	<b>273</b>
JUNTAS DEL SISTEMA DE ADMISIÓN	273
<b>SISTEMA DE ESCAPE</b>	<b>268</b>
JUNTAS DE COLECTOR Y CARTER	270
JUNTAS DE SISTEMA DE ESCAPE	268
<b>UNIDADES DE TRANSMISIÓN</b>	<b>277</b>
<b>COLA COMPLETA</b>	<b>277</b>
COLAS DE 4 TIEMPOS	277
COLAS DE 2 TIEMPOS	279
<b>DESPIECE COLAS 4 TIEMPOS</b>	<b>282</b>
F2.5	282
F4	284
F5	286
F6 • F8 • F9.9	288
F13.5 • F15	290
F20 • F25	292
F30 • F40	298
F50 • F60	306
F70	314
F80 • F100	318
F115 • F130	322
F150 • F175 • F200	326
F225	330
F250 • F300	334
F350	340
<b>DESPIECE COLAS 2 TIEMPOS</b>	<b>342</b>
2	342
4 • 5	344
6 • 8	346
9.9	348
13.5 • 15	350
20 • 25 • 30	352
40 • 50	358
55	368
75 • 85	370
80 • 90	372
115 • 130	374
V6	378
225 • 250	382
VZ200 • VZ205 • VZ250 • VZ300	386
<b>GUÍA PIEZAS COLA</b>	<b>387</b>
<b>GUÍA RODAMIENTOS</b>	<b>393</b>
<b>SISTEMA DE PROPULSIÓN</b>	<b>401</b>
<b>HÉLICES ALUMINIO E INOXIDABLE DE 3 Y 4 PALAS</b>	<b>401</b>
GUÍA HÉLICES CON NÚCLEO INTEGRADO	402
GUÍA DE RECAMBIOS DE HÉLICE	405
HÉLICES PARA NÚCLEO INTERCAMBIABLE	404
NÚCLEO INTERCAMBIABLE	405
REF --> RO	406
RO --> REF	420

## EN

<b>DRIVES MAINTENANCE GUIDE &amp; KITS</b>	<b>64</b>	CONTROL BOX	113
<b>FUEL &amp; FILTRATION SYSTEM</b>	<b>74</b>	DASH MOUNT	113
<b>ACCELERATOR</b>	<b>101</b>	DUAL ENGINE APPLICATION	113
VARILLA DE ACELERADOR	101	KEY FOR STERN CONTROL	114
<b>CARBURATOR</b>	<b>91</b>	PUSH T. CHOKE	114
ACCELEROGRAPH CONTROL	100	<b>REGULATOR AND RECTIFIERS</b>	<b>116</b>
BOLT SCREW	98	<b>SENSORS</b>	<b>102</b>
CARBURETOR GASKETS	94	MAP SENSOR	102
CARBURETOR KITS	95	OXYGEN SENSOR	103
ELEMENT FILTER (CARB INLET)	101	TPS SENDER	102
FLOATS	100	SENSOR	103
FULL CARBURATOR	91	SENSOR, OIL PRESSURE	103
GUIDE CARBURETORS	93	SENSOR, WATER TEMPERATURE	103
KIT 3 CARBURETORS	92	<b>SOLENOID RELAY</b>	<b>114</b>
NEEDLE VALVE	98	<b>STARTERS</b>	<b>110</b>
PIN FLOAT	99	CONNECTION LINE, POWER	112
VALVE OF SHEETS	99	PAWL, DRIVE	112
<b>FUEL FILTERS AND ELEMENTS</b>	<b>77</b>	PLATE & DRUM, DRIVE	113
BRACKET	77	STARTER HANDLE ASSY	113
COMPLET FUEL FILTER, TRANSPARENT BOWL	78	STEERING SPRING	112
FUEL FILTER GUIDE	82	<b>STARTOR</b>	<b>121</b>
FUEL FILTER GUIDE VST	81	<b>TRIM, TILT &amp; POWER TRIM</b>	<b>122</b>
FILTER KEY	79	COMPLETE POWER TRIM ASSEMBLY	124
IN-LINE FUEL FILTER	80	COMPLETE TRIM ASSEMBLY	122
RACOR MADE IN BRASS	79	PARTI PISTONE TRIM	125
VST FILTER	82	POWER TRIM SWITCH	122
WATER SEPARATING FUEL FILTER	77	TRIM PLUGS EXTRACTOR	125
<b>FUEL PUMP</b>	<b>85</b>	WIRING HARNESS	122
DIAPHRAGMS & GASKETS	87	<b>STEERING SYSTEM</b>	<b>126</b>
FUEL PUMP ELECTRIC	86	<b>ARNES</b>	<b>128</b>
FUEL PUMP MECHANICAL	85	ARNES ASSY (703)	128
FUEL REGULATOR	89	ARNES EXTENSION (703/704)	128
VST GASKETS	88	<b>BRACKET</b>	<b>131</b>
<b>FUEL PUMP IN LINE</b>	<b>74</b>	BOLT, CLAMP BRACKET	131
CLAMP SMALL	75	BRACKET OIL SEAL	132
COUPLER	75	BRACKET ROTARY	131
FUEL HOSE	74	CIRCLIP	132
FUEL LINE ASSEMBLY	74	CONNECTOR	132
FUEL PUMP	74	LEFT BRACKET ASSY	131
SPRING, FUEL PIPE	75	OILER M6	133
<b>FUEL TANK COMPONENTS &amp; CONNECTORS</b>	<b>75</b>	RIGHT BRACKET ASSY	131
FILTER	76	SHELL, MOUNT DAMPER	132
KNOB OIL SWITCH	76	THROTTLE SHAFT CONNECTOR	132
OLEOMETER ASSY	76	TILT ROD	132
PLUG	75	<b>BUSHINGS</b>	<b>133</b>
PLUG WITH BREATHER	75	<b>COMPONENTS 703</b>	<b>129</b>
TANK CONNECTOR	76	BLOCK CONTROL HANDLE	130
THRU HULL	77	CONTROL CABLES	130
SPRING, PREVENT DESQUAMATING	75	LEVER THROTTLE	130
<b>INJEKTOR</b>	<b>89</b>	LINK ROD ASSY	130
GUIDE INJECTORS & SENDERS	90	PLATE CONTROL BOX	129
INJEKTOR	89	THROTTLE CABLE	129
<b>OIL</b>	<b>84</b>	THROTTLE HANDLE INCHING	129
<b>OIL FILTER</b>	<b>83</b>	<b>ENGINE CONTROLS</b>	<b>126</b>
OIL FILTER GUIDE	83	CABLE CONNECTOR	127
<b>OIL INJECTION PUMP</b>	<b>84</b>	CONSOLE CONTROL	127
<b>ELECTRIC SYSTEM</b>	<b>102</b>	SIDE CONTROL PUSH TO OPEN	126
CDI & POWER PACK	117	SIDE CONTROL	127
<b>COILS</b>	<b>104</b>	HANDLE GEAR SHIFT ASSY	134
COIL LIGHTING	104	SILENBLOCK	135
CHARGE COIL	106	<b>STARTER HANDLE &amp; FIXINGS</b>	<b>134</b>
IGNITION COIL	104	<b>STEERING HANDLE ASSY</b>	<b>134</b>
PULSER COIL	107	<b>SWITCHES FOR ENGINE CONTROLS</b>	<b>127</b>
SPARK	108	PANEL TWIN STATION	128
T.C.I. COIL	106	POWER TRIM SWITCH (703)	127
<b>CUT OFF SWITCHES</b>	<b>120</b>	SWITCH (704)	128
KIT	121	<b>WASHER, BELOW</b>	<b>133</b>
<b>FLYWHELL</b>	<b>109</b>	<b>COOLING SYSTEM</b>	<b>136</b>
ELECTRIC	109	<b>ANODES</b>	<b>158</b>
WITHOUT TOOTH	109	ANODES APPLICATION	169
<b>IGNITION STARTER SWITCH</b>	<b>113</b>	ANODES CANADA METAL	158

ANODES KIT CANADA METAL	162	GUIDE PISTON & RING	266	GUIDA MANUTENZIONE E KIT	64
ANODES KIT TECNOSEAL	168	PISTON KITS	262	<b>SISTEMA DI ALIMENTAZIONE E FILTRAZIONE</b>	74
ANODES TECNOSEAL	163	<b>EXHAUST &amp; INTAKE SYSTEM</b>	268	ACCELERATORE	101
COVER ANODE (66M)	168	<b>EXHAUST SYSTEM</b>	268	ASTA ACCELERATORE	101
<b>GASKETS KIT</b>	144	EXHAUST GASKETS	268	<b>CARBURATORE</b>	91
<b>IMPELLER GUIDE</b>	143	GASKET, UPPERCASING, OIL PAN, MANIFOLD	270	CARBURATORE COMPLETO	91
<b>SALT OFF</b>	136	<b>INTAKE SYSTEM</b>	273	CONTROLLO DELL'ACCELEROGRAFO	100
<b>THERMOSTAT</b>	136	GASKETS INTAKE	273	FILTRO CARBURATORE	101
GASKET, EXHAUST INNER COVER	140	<b>UNIT DRIVES &amp; COMPONENTS</b>	277	GALLEGGIANTE	100
NIPPLE	139	<b>COMPLETE GEARCASE ASSY</b>	277	GUARNIZIONI CARBURATORI	94
SPRING	139	4 STROKES GEARCASE	277	GUIDA CARBURATORI	93
THERMOSTAT	136	2 STROKES GEARCASE	279	KIT CARBURATORI	95
THERMOSTAT COVER	139	<b>GEAR CASE PARTS 4 STROKES</b>	282	KIT 3 CARBURATORI	92
THERMOSTAT GASKETS	138	F2.5	282	SPILLO CONICO CARBURATORE	98
THERMOSTAT GUIDE	137	F4	284	SPINOTTO GALLEGGIANTE	99
THERMOSTAT, PRESSURE VALVE	139	F5	286	VALVOLA	99
<b>WATER PUMP</b>	147	F6 • F8 • F9.9	288	VITE CARBURATORE	98
GUIDE WATER PUMP 4 STROKES	154	F13.5 • F15	290	<b>COMPONENTI SERBATOIO E CONETTORI</b>	75
GUIDE WATER PUMP 2 STROKES	155	F20 • F25	292	ATTACCO SERBATOIO	76
GUIDE WATER PUMP SERVICE KITS	153	F30 • F40	298	CHIAVE DE DEPOSITO BLOCCO	76
HOUSING, WATER PUMP	147	F50 • F60	306	FILTRO	76
WATER PUMP, COVER	148	F70	314	MISURATORE DI CARBURANTE	76
WATER PUMP SERVICE KITS	150	F80 • F100	318	MOLLA SICURTÀ PER TAPPO	75
<b>ENGINE PARTS</b>	170	F115 • F130	322	PASSASCAFO	77
<b>CRANKSHAFT 4 STROKES</b>	219	F150 • F175 • F200	326	SPINA CON RESPIRO	75
GUIDE CRANKSHAFT ASSY	219	F225	330	TAPPO	75
<b>CRANKSHAFT 2 STROKES</b>	256	F250 • F300	334	<b>FILTRI BENZINA E RACCORDI</b>	77
GUIDE CONNECTING ROD	260	F350	340	CHIAVE DA FILTRO	79
GUIDE CRANKSHAFT ASSY	256	<b>GEARCASE PARTS 2 STROKES</b>	342	FILTRO BENZINA PER MONTARE IN LINEA	80
GUIDE CRANKSHAFT PARTS	256	2	342	FILTRO DI DECANTAZIONE BENZINA	78
GUIDE ENGINE BEARING	257	4 • 5	344	COMPLETO CON VASCHETTA TRASPARENTE	78
<b>ENGINE GASKET 4 STROKES</b>	215	6 • 8	346	FILTRO SEPARATORE ACQUA-BENZINA	77
ENGINE GASKET GUIDE	218	9.9	348	FILTRO VST	82
CYLINDER GASKET	217	13.5 • 15	350	GUIDA FILTRO BENZINA	81
CYLINDER HEAD GASKET	215	20 • 25 • 30	352	GUIDA FILTRO BENZINA VST	82
CYLINDER HEAD GASKET KIT	216	40 • 50	358	RACCORDO IN OTTONE	79
<b>ENGINE GASKET 2 STROKES</b>	248	55	368	SUPPORTO	77
ENGINE GASKET GUIDE	254	75 • 85	370	<b>FILTRO OLIO</b>	83
CYLINDER GASKET	252	80 • 90	372	GUIDA FILTRO OLIO	83
CYLINDER HEAD GASKET	248	115 • 130	374	<b>INIETTORE</b>	89
CYLINDER HEAD GASKET KIT	249	V6	378	GUIDA INIETTORI E SENSORI	90
GASKET, HEAD COVER	255	225 • 250	382	INIETTORE	89
<b>ENGINE PARTS 4 STROKES</b>	170	VZ200 • VZ205 • VZ250 • VZ300	386	<b>OLIO</b>	84
F2.5	170	<b>STERN DRIVE BEARING APPLICATION</b>	393	<b>POMPA BENZINA IN LINEA</b>	74
F4	174	<b>STERN DRIVE COMPONENTS GUIDE</b>	387	ADATTATORE	75
F5 • F6	178	<b>PROPULSION SYSTEM</b>	401	FASCETTE	75
F8	181	<b>3 &amp; 4 BLADE ALUMINIUM &amp; SS PROPELLERS</b>	401	MOLLA TUBO COMBUSTIBILE	75
F9.9	180	INTERCHANGEABLE HUB	405	POMPA BENZINA	74
F13.5 • F15	182	PROPELLERS APPLICATION WITH RUBBER HUB	402	TUBO BENZINA	74
F20 • F25	190	PROPELLERS FOR INTERCHANGEABLE HUB	404	TUBO CARBURANTE	74
F30 • F40	196	PROPELLER SPARE PARTS	405	<b>POMPA BENZINA</b>	85
F50 • F60	202	<b>REF --&gt; OEM</b>	406	GUARNIZIONE VST	88
F70	204	<b>OEM --&gt; REF</b>	420	MEMBRANA E GUARNIZIONI	87
F80 • F100 • F115	208			POMPA BENZINA ELETTRICA	86
F150	210			POMPA BENZINA MECCANICA	85
F200 • F225 • F250	212			REGOLATORE BENZINA	89
F300 • F350	214			<b>POMPA INIEZIONE BENZINA</b>	84
<b>ENGINE PARTS 2 STROKES</b>	220			<b>SISTEMA ELETTRICO</b>	102
2	220			<b>BOBINE</b>	104
4 • 5	221			BOBINE ACCENSIONE	107
6 • 8	222			BOBINA AVVIAMENTO	104
9.9 • 13.5 • 15	226			BOBINA DI CARICA	106
25 • 30	228			BOBINA LUCE	104
40	232			BOBINE T.C.I.	106
48 • 55	238			CANDELE	108
50 • 60 • 70	240			<b>CDI E CENTRALINA</b>	117
75 • 85	242			<b>CHIAVETTA DI SICUREZZA</b>	120
100 • 115 • 130 • 140	244			KIT	121
150 • 175 • 200 • 225	246			<b>CHIAVI DI ACCENSIONE</b>	113
<b>GUIDE TIMING BELT</b>	267			CHIAVE CON CONTATTO	114
<b>PISTONS 4 STROKES</b>	219			CHIAVE DOPPIA INSTALLAZIONE	113
PISTON KITS	219			CHIAVE PER COMANDO A GUIDA	114
<b>PISTON 2 STROKES</b>	262			MONTAGGIO NEL PANNELLO	113
				MONTAGGIO NEL TELECOMANDO	113
				<b>MOTORINI AVVIAMENTO</b>	110
				CAVO MOTORE DI AVVIAMENTO A BATTERIA	112
				CRICCHETTO TRAZIONE PLATTO	112
				MANIGLIA AVVIAMENTO	113
				MOLLA AVVIAMENTO	112
				PLACCA E PLATTO DI AVVIAMENTO MANUALE	113
				<b>REGOLATORI E RADDRIZZATORI</b>	116





<b>FILTRE À ESSENCE ET CARTOUCHE DE RECHANGE</b>	77	ETRIER DROIT	131	F150	210
CLÉ À FILTRE	79	ETRIER GAUCHE	131	F200 • F225 • F250	212
FILTRE À ESSENCE	77	CONNECTEUR	132	F300 • F350	214
FILTRE À ESSENCE EN LIGNE	80	GRAISSEUR M6 INOX 316	133	<b>PIECES MOTEUR 2 TEMPS</b>	220
FILTRE SÉPARATEUR D'ESSENCE	78	JOINT INFÉRIEUR DU SUPPORT	132	2	220
FILTRE VST	82	SUPPORT SILENT BLOCK	132	4 • 5	221
GUIDE FILTRE À ESSENCE	81	SUPPORT TOURNANT	131	6 • 8	222
GUIDE FILTRES VST	82	TUBE SUPPORT CABLE DE DIRECTION	131	9.9 • 13.5 • 15	226
RACCORD EN LAITON	79	TIGE DE CONNEXION ACCELERATEUR	132	25 • 30	228
TÊTE DE FILTRE À ESSENCE	77	<b>CALLE</b>	133	40	232
<b>FILTRE À HUILE</b>	83	COMMANDE D'INVERSION	134	48 • 55	238
GUIDE FILTRE A HUILE	83	<b>COMPOSANT (703)</b>	129	50 • 60 • 70	240
<b>HUILES</b>	84	BARRE D'ACCOUPLLEMENT COMPLETE	130	75 • 85	242
<b>INJECTEURS</b>	89	CÂBLE D'ACCELERATEUR	129	100 • 115 • 130 • 140	244
GUIDE INJECTEURS ET SONDÉS	90	CÂBLES DE COMMANDE	130	150 • 175 • 200 • 225	246
INJECTEUR	89	CALE POIGNEE DE CONTRÔLE	130	<b>PISTONS DE 2 TEMPS</b>	262
<b>POIRE À CARBURANT</b>	74	LEVIER DE COMMANDE	131	KIT DE PISTONS	262
COLLIER	75	PLAQUE BOITIER DE COMMANDE	129	GUIDE PISTONS ET SEGMENTS	266
POIRE À CARBURANT	74	POIGNEE DE PAPILLON	129	<b>PISTONS DE 4 TEMPS</b>	219
RACCORD COUPLEUR	75	ROUE D'ACCELERATEUR	130	KIT PISTON	219
RESSORT, TUYAU DE CARBURANT	75	<b>FAISCEAU ELECTRIQUE</b>	128	<b>VILEBREQUIN DE 4 TEMPS</b>	219
TUYAU CARBURANT	75	FAISCEAU ELECTRIQUE BOITIER CDE (703)	128	GUIDE VILEBREQUIN COMPLET	219
<b>POMPE À ESSENCE</b>	85	RALLONGE FAISCEAU (703/704)	128	<b>VILEBREQUIN DE 2 TEMPS</b>	256
POMPE À ESSENCE ELECTRIQUE	86	<b>INTERRUPTEUR DE CONTRÔLE</b>	127	GUIDE DE BIELLES	260
POMPE À ESSENCE MECANIQUE	85	BOITIER DE DEMARRAGE 2 MOTEURS	128	GUIDE PARTS DE VILEBREQUIN	256
JOINTS VST	88	COMMUTATEUR DE TRIM (703)	127	GUIDE ROULEMENTS DE MOTEUR	257
MEMBRANES ET JOINTS	87	TABLEAU DE COMMANDE SIMPLE (704)	128	GUIDE VILEBREQUIN COMPLET	256
REGULATEUR DE PRESSION D'ESSENCE	89	<b>POIGNEE DE DIRECTION</b>	134	<b>SYSTÈME D'ÉCHAPPEMENT ET SYSTÈME D'ADMISSION</b>	268
<b>POMPE D'INJECTION D'HUILE</b>	84	<b>POIGNEE LANCEUR ET DE SERRAGE</b>	134	<b>SYSTÈME D'ADMISSION</b>	273
		<b>SILENT BLOC</b>	135	JOINTS D'ADMISSION	273
<b>SYSTÈME ÉLECTRIQUE</b>	102	<b>SYSTÈME DE REFROIDISSEMENT</b>	136	<b>SYSTÈME D'ÉCHAPPEMENT</b>	268
<b>BOBINES</b>	104	<b>ANODES</b>	158	JOINTS D'ÉCHAPPEMENT	268
BOBINE D'ALLUMAGE	104	ANODE CANADA METAL	158	JOINTS DE COLLECTEUR ET CARTER D'HUILE	270
BOBINE D'ÉCLAIRAGE	104	ANODE TECNOSEAL	163	<b>EMBASES ET PIECES</b>	277
BOBINE DE CHARGE	106	COUVERCLE DU ANODE (66M)	168	<b>EMBASE COMPLETE</b>	277
BOBINE PULSEUR	107	GUIDE DES ANODES	169	EMBASES DE MOTEUR 4T	277
BOBINE T.C.I.	106	KIT ANODES CANADA METAL	162	EMBASES DE MOTEUR 2T	279
BOUGIES	108	KIT ANODES TECNOSEAL	168	<b>PIECES D'EMBASES DE 4 TEMPS</b>	282
<b>CDI ET BOITIER ELECTRONIQUE</b>	117	<b>GUIDE TURBINES</b>	143	F2.5	282
<b>CONTACTEUR A CLÉ</b>	113	<b>KITS JOINTS</b>	144	F4	284
AVEC STARTER	114	<b>POMPE D'EAU</b>	147	F5	286
CONTACTEUR A CLÉ COMPLET	114	CORPS DE POMPE À EAU	147	F6 • F8 • F9.9	288
MONTAGE POUR BOITIER DE COMMANDE	113	GUIDE KITS POMPES À EAU	153	F13.5 • F15	290
MONTAGE POUR TABLEAU DE BORD	113	GUIDE POMPE À EAU 4T	154	F20 • F25	292
POUR INSTALLATION DOUBLE	113	GUIDE POMPE À EAU 2T	155	F30 • F40	298
<b>CAPTEURS</b>	102	GUIDE POMPE À EAU	150	F50 • F60	306
CAPTEUR D'ACCELERATEUR TS	103	KIT REPARATION DE POMPE À EAU	148	F70	314
CAPTEUR DE TEMPERATURE	103	PLAQUE DE POMPE À EAU	148	F80 • F100	318
CAPTEUR MAP	102	<b>THERMOSTAT</b>	136	F115 • F130	322
CAPTEUR TPS	102	COUVERCLE DE THERMOSTAT	139	F150 • F175 • F200	326
SONDE À OXYGENE	103	GUIDE DES THERMOSTATS	137	F225	330
SONDE DE PRESSION D'HUILE	103	GUIDE DES THERMOSTATS	137	F250 • F300	334
<b>COUPE CIRCUIT DE SECURITE</b>	120	JOINT DE PLAQUE DE REFROIDISSEMENT	140	F350	340
KITS	121	JOINTS DE THERMOSTAT	138	<b>PIECES D'EMBASES DE 2 TEMPS</b>	342
<b>DEMARREUR</b>	110	RESSORT	139	2	342
CABLE DE CONNEXION	112	SOUPAPE DE PRESSION DE THERMOSTAT	139	4 • 5	344
ENTRAÎNEMENT	112	TETINE	139	6 • 8	346
POIGNEE DE LANCEUR	113	THERMOSTAT	136	9.9	348
RESSORT DE LANCEUR	112	<b>SALT OFF</b>	136	13.5 • 15	350
TAMBOUR, POULIE	113	<b>PIECES MOTEUR</b>	170	20 • 25 • 30	352
<b>REGULATEURS ET RECTIFIEURS</b>	116	<b>GUIDE DES COURROIES DE DISTRIBUTION</b>	267	40 • 50	358
<b>SOLENOIDE RELAIS</b>	114	<b>JOINTS DE MOTEUR 4 TEMPS</b>	215	55	368
<b>STARTOR</b>	121	GUIDE JOINTS DE MOTEURS	218	75 • 85	370
<b>TRIM, TILT &amp; POWER TRIM</b>	122	JOINTS DE CULASSE	215	80 • 90	372
INTERRUPTEUR DE TRIM	122	JOINTS DE TÊTE MOTRICE	217	115 • 130	374
INSTALLATION ELECTRIQUE	122	KIT JOINTS DE CULASSE	216	V6	378
KIT EXTRACTEUR	125	<b>JOINTS DE MOTEUR 2 TEMPS</b>	248	225 • 250	382
MOTEUR DE TRIM	122	GUIDE JOINTS DE MOTEURS	254	VZ200 • VZ205 • VZ250 • VZ300	386
PIECES VERIN DE TRIM	125	JOINT DE CULASSE	248	<b>GUIDE PIECES D'EMBASE</b>	387
POWER TRIM COMPLET	124	JOINTS DE COUVRE CULASSE	255	<b>GUIDE ROULEMENTS D'EMBASE</b>	393
<b>VOLANT MOTEUR</b>	109	JOINTS DE TÊTE MOTRICE	252	<b>SYSTÈME DE PROPULSION</b>	401
ÉLECTRIQUE	109	KITS JOINT DE CULASSE	249	<b>HELICE ALUMINIUM ET INOX 3 ET 4 PALES</b>	401
MANUEL SANS DENT	109	<b>PIECES MOTEURS DE 4 TEMPS</b>	170	GUIDE DES HELICES ET MOYEUX	402
<b>SYSTÈME DE DIRECTION</b>	126	F2.5	170	GUIDE DES PIECES POUR HELICE	405
<b>BAGUES</b>	133	F4	174	HELICES AVEC MOYEU INTERCHANGEABLE	404
<b>BOITIER DE COMMANDE</b>	126	F5 • F6	178	MOYEU INTERCHANGEABLE	405
BOITIER LATERAL <small>PUSH TO OPEN</small>	126	F8	181	<b>REF --&gt; RO</b>	406
BOITIER LATERAL	127	F9.9	180	<b>RO --&gt; REF</b>	420
BOITIER POUR CONSOLE	127	F13.5 • F15	182		
EMBOUT DE CABLE	127	F20 • F25	190		
<b>BRACKET</b>	131	F30 • F40	196		
BARRE DE TILT	132	F50 • F60	202		
CIRCLIP	132	F70	204		
		F80 • F100 • F115	208		

GUÍA KITS  
MANTENIMIENTO

MAINTENANCE  
GUIDE & KITS

GUIDA  
MANUTENZIONE  
E KIT

GUIDE  
MAINTENANCE  
KITS

	KIT	REF							
	RECKITF2.5A	NGKBR6HS	BUJÍA	SPARK PLUG	CANDELE	BOUGIE	1		
		PAF4-04070003	ÁNODO	ANODE	ANODO	ANODE	1		
		PAF4-04000011	JUNTA	GASKET	GUARNIZIONE	JOINT	1		
		PAF4-04000006	JUNTA	GASKET	GUARNIZIONE	JOINT	1		
		PAF4-04120005	FILTRO COMBUSTIBLE	FUEL FILTER	FILTRO COMBUSTIBILE	FILTRE ESSENCE	1		
		REC90430-08020	JUNTA DESAGÜE	DRAIN GASKET	GUARNIZIONE DRENAGGIO	JOINT DE VIDANGE	x 2		
		PAF4-03000022	ÁNODO	ANODE	ANODO	ANODE	1		
		PAGB/T91-1.6X12	PIN BLOQUEADOR	COTTER PIN	COPPIGLIA	GOUPILLE	1		
		PAF2.6-03000013	PIN	PIN	PIN	PIN	1		
		PAF2.6-03000100	TURBINA	IMPELLER	GIRANTE	TURBINE	1		
		PAJASOF404-19-033	TÓRICA	O-RING	O-RING	JOINT TORIQUE	1		
			RECKITF2.5B	NGKCR6HSB	BUJÍA	SPARK PLUG	CANDELE	BOUGIE	1
				PAF4-04070003	ANODO	ANODE	ANODO	ANODE	1
PAF4-04000011	JUNTA			GASKET	GUARNIZIONE	JOINT	1		
PAF4-04000006	JUNTA			GASKET	GUARNIZIONE	JOINT	1		
PAF4-04120005	FILTRO COMBUSTIBLE			FUEL FILTER	FILTRO COMBUSTIBILE	FILTRE ESSENCE	1		
REC90430-08020	JUNTA DESAGÜE			DRAIN GASKET	GUARNIZIONE DRENAGGIO	JOINT DE VIDANGE	x 2		
PAF4-03000022	ÁNODO			ANODE	ANODO	ANODE	1		
PAGB/T91-1.6X12	PIN BLOQUEADOR			COTTER PIN	COPPIGLIA	GOUPILLE	1		
PAF2.6-03000013	PIN			PIN	PIN	PIN	1		
PAF2.6-03000100	TURBINA			IMPELLER	GIRANTE	TURBINE	1		
	RECKITF4A			NGKBR6HS	BUJÍA	SPARK PLUG	CANDELE	BOUGIE	1
				PAF4-04070003	ANODO	ANODE	ANODO	ANODE	1
				PAF4-04000011	JUNTA	GASKET	GUARNIZIONE	JOINT	1
		PAF4-03000018	JUNTA	GASKET	GUARNIZIONE	JOINT	1		
		PAF4-05000300	FILTRO COMBUSTIBLE	FUEL FILTER	FILTRO COMBUSTIBILE	FILTRE ESSENCE	1		
		REC90430-08020	JUNTA DESAGÜE	DRAIN GASKET	GUARNIZIONE DRENAGGIO	JOINT DE VIDANGE	x 2		
		PAF4-03000022	ÁNODO	ANODE	ANODO	ANODE	1		
		PAGB/T91-1.6X12	PIN BLOQUEADOR	COTTER PIN	SPINOTTO	PIN	1		
		PAF4-03000016	PIN	PIN	PIN	PIN	1		
		PAF4-03060000	TURBINA	IMPELLER	GIRANTE	TURBINE	1		
		PAF4-04000030	MUELLE DEL TUBO DE COMBUSTIBLE	CLAMP	MOLLA TUBO COMBUSTIBILE	COLLIER TUYAU DE CARBURANT	x 2		
		PAF4-04000006	JUNTA	GASKET	GUARNIZIONE	JOINT	1		
			RECKITF5A	NGKCR6HSB	BUJÍA	SPARK PLUG	CANDELE	BOUGIE	1
PAF4-04070003	ANODO			ANODE	ANODO	ANODE	1		
PAF4-04000011	JUNTA			GASKET	GUARNIZIONE	JOINT	1		
PAF4-03000018	JUNTA			GASKET	GUARNIZIONE	JOINT	1		
REC68T-24251-00	FILTRO COMBUSTIBLE			FUEL FILTER	FILTRO COMBUSTIBILE	FILTRE ESSENCE	1		
REC90430-08020	JUNTA DESAGÜE			DRAIN GASKET	GUARNIZIONE DRENAGGIO	JOINT DE VIDANGE	x 2		
PAF4-03000022	ÁNODO			ANODE	ANODO	ANODE	1		
PAGB/T91-1.6X12	PIN BLOQUEADOR			COTTER PIN	COPPIGLIA	GOUPILLE	1		
PAF4-03000016	PIN			PIN	PIN	PIN	1		
PAF4-03060000	TURBINA			IMPELLER	GIRANTE	TURBINE	1		
PAF4-04000030	MUELLE DEL TUBO DE COMBUSTIBLE			SPRING, FUEL PIPE	MOLLA TUBO COMBUSTIBILE	COLLIER TUYAU DE CARBURANT	x 2		
PAF4-04000006	JUNTA			GASKET	GUARNIZIONE	JOINT	1		
	RECKITF6A			NGKBR6HS-10	BUJÍA	SPARK PLUG	CANDELE	BOUGIE	x 2
		PAF4-04070003	ANODO	ANODE	ANODO	ANODO	1		
		PAJASOF40431-025	TÓRICA	O-RING	O-RING	JOINT TORIQUE	1		
		PAGB/T3452.1-13X2	TÓRICA	O-RING	O-RING	JOINT TORIQUE	1		
		REC68T-24251-00	FILTRO COMBUSTIBLE	FUEL FILTER	FILTRO COMBUSTIBILE	FILTRE ESSENCE	1		
		PAF4-04000030	MUELLE DEL TUBO DE COMBUSTIBLE	SPRING, FUEL PIPE	MOLLA TUBO COMBUSTIBILE	COLLIER TUYAU DE CARBURANT	x 2		
		REC09168-12017	ARANDELA	WHASER	RONDELLA	RONDELLE	1		
		CM68T-45251-00A	ANODO	ANODE	ANODO	ANODO	1		
		REC90430-08020	JUNTA DESAGÜE	DRAIN GASKET	GUARNIZIONE DRENAGGIO	JOINT DE VIDANGE	x 2		
		REC91490-30025	PIN BLOQUEADOR	COTTER PIN	COPPIGLIA	GOUPILLE	1		
		REC68T-W0078-00	KIT BOMBA DE AGUA	WATER PUMP REPAIR KIT	KIT POMPA DELL'ACQUA	KIT POMPE À EAU	1		
			RECKITF6C	NGKCR6HSB	BUJÍA	SPARK PLUG	CANDELE	BOUGIE	1
				PAF4-04000011	JUNTA	GASKET	GUARNIZIONE	JOINT	1
PAF4-04070003	ANODO			ANODE	ANODO	ANODO	1		
REC68T-24251-00	FILTRO COMBUSTIBLE			FUEL FILTER	FILTRO COMBUSTIBILE	FILTRE ESSENCE	1		
REC90430-08020	JUNTA DESAGÜE			DRAIN GASKET	GUARNIZIONE DRENAGGIO	JOINT DE VIDANGE	x 2		
CM6L5-45251-02A	ANODO			ANODE	ANODO	ANODO	1		
PAF4-04000006	JUNTA			GASKET	GUARNIZIONE	JOINT	1		
PAJASOF40431-025	TÓRICA			O-RING	O-RING	JOINT TORIQUE	1		
PAF4-03000018	JUNTA			GASKET	GUARNIZIONE	JOINT	1		
PAF4-03060000	TURBINA			IMPELLER	GIRANTE	TURBINE	1		
PAF4-03000016	PIN			PIN	PIN	PIN	1		
PAGB/T91-1.6X12	PIN BLOQUEADOR			COTTER PIN	COPPIGLIA	GOUPILLE	1		

	KIT	REF								
	RECKITFT8D	FT8 D/G (2001-14)	NGKBR6HS-10	BUJÍA	SPARK PLUG	CANDELE	BOUGIE	x 2		
		FT9.9G (2008-12)	PAF4-04070003	ANODO	ANODE	ANODO	ANODO	1		
		FT9.9J (2013 +)	PAJASOF40431-025	TÓRICA	O-RING	O-RING	O-RING	JOINT TORIQUE	1	
			PAGB/T3452.1-13X2	TÓRICA	O-RING	O-RING	O-RING	JOINT TORIQUE	1	
			REC68T-24251-00	FILTRO COMBUSTIBLE	FUEL FILTER	FUEL FILTER	FILTRO COMBUSTIBILE	FILTRE ESSENCE	1	
			PAF4-04000030	MUELLE DEL TUBO DE COMBUSTIBLE	SPRING, FUEL PIPE	MOLLA TUBO COMBUSTIBILE	MOLLA TUBO COMBUSTIBILE	COLLIER TUYAU DE CARBURANT	x 2	
			REC09168-12017	ARANDELA	WHASER	WHASER	RONDELLA	RONDELLE	1	
			CM68T-45251-00A	ANODO	ANODE	ANODE	ANODO	ANODO	1	
			REC90430-08020	JUNTA DESAGÜE	DRAIN GASKET	DRAIN GASKET	GUARNIZIONE DRENAGGIO	JOINT DE VIDANGE	x 2	
			REC91490-30025	PIN BLOQUEADOR	COTTER PIN	COTTER PIN	COPPIGLIA	GOUPILLE	1	
			CM61N-45251-01A	ANODO	ANODE	ANODE	ANODO	ANODO	1	
			REC68T-W0078-00	KIT BOMBA DE AGUA	WATER PUMP REPAIR KIT	WATER PUMP REPAIR KIT	KIT POMPA DELL'ACQUA	KIT POMPE À EAU	1	
			CM6E0-45251-11A	ANODO	ANODE	ANODE	ANODO	ANODO	1	
			RECKITF9.9C	F9.9C (1998-08)	REC5GH-13440-00	FILTRO DE ACEITE	OIL FILTER	FILTRO OLIO	FILTRE D'HUILE	1
				F15A (1998-07)	CM66M-11325-00A	ANODO	ANODE	ANODE	ANODE	1
	PAF15-07010009			ALOJAMIENTO DEL ANODO	SEAL ANODE	SEAL ANODE	ALLOGGIAMENTO ANODO	JOINT D'ANODE	1	
	CM15026A			ANODO	ANODE	ANODE	ANODO	ANODE	1	
	PAF15-07010018			JUNTA	GASKET	GASKET	GUARNIZIONE	JOINT	1	
	PAJASOF40431-025			TÓRICA	O-RING	O-RING	O-RING	JOINT TORIQUE	1	
	NGKDP6EA-9			BUJÍA	SPARK PLUG	SPARK PLUG	CANDELE	BOUGIE	x 2	
	REC61N-24563-10			FILTRO COMBUSTIBLE	FUEL FILTER	FUEL FILTER	FILTRO COMBUSTIBILE	FILTRE ESSENCE	1	
	PAGB/T3452.1-32.5X1.8			ARANDELA	WHASER	WHASER	RONDELLA	RONDELLE	1	
	PAF15-04000003			ARANDELA	WHASER	WHASER	RONDELLA	RONDELLE	1	
	REC90430-08020			JUNTA DESAGÜE	DRAIN GASKET	DRAIN GASKET	GUARNIZIONE DRENAGGIO	JOINT DE VIDANGE	x 2	
	CM61N-45251-01A			ANODO	ANODE	ANODE	ANODO	ANODO	1	
	TEN01136			ANODO	ANODE	ANODE	ANODO	ANODO	1	
	REC91490-30025			PIN BLOQUEADOR	COTTER PIN	COTTER PIN	COPPIGLIA	GOUPILLE	1	
	REC63V-W0078-01			KIT BOMBA DE AGUA	WATER PUMP REPAIR KIT	WATER PUMP REPAIR KIT	KIT POMPA DELL'ACQUA	KIT POMPE À EAU	1	
	CM6E0-45251-11A	ANODO	ANODE	ANODE	ANODO	ANODO	1			
	RECKITF15C	F15C (2007+)	CM6G8-11325-00A	ANODO	ANODE	ANODO	ANODO	x 3		
			PAF20-05000702	JUNTA	GASKET	GASKET	GUARNIZIONE	JOINT	1	
			PAGB/T3452.1-13X2	JUNTA	GASKET	GASKET	GUARNIZIONE	JOINT	1	
			REC5GH-13440-60	FILTRO DE ACEITE	OIL FILTER	OIL FILTER	FILTRO OLIO	FILTRE D'HUILE	1	
			PAJASOF40431-025	TÓRICA	O-RING	O-RING	O-RING	JOINT TORIQUE	1	
			NGKDP6EB-9	BUJÍA	SPARK PLUG	SPARK PLUG	CANDELE	BOUGIE	x 2	
			PAF15-07010018	JUNTA	GASKET	GASKET	GUARNIZIONE	JOINT	1	
			REC93210-32738	TÓRICA	O-RING	O-RING	O-RING	JOINT TORIQUE	1	
			CM6E0-45251-11A	ANODO	ANODE	ANODE	ANODO	ANODO	1	
			PAF15-04000003	JUNTA	GASKET	GASKET	GUARNIZIONE	JOINT	1	
			TEN01154AL	ANODO	ANODE	ANODE	ANODO	ANODO	1	
			REC91490-30025	PIN BLOQUEADOR	COTTER PIN	COTTER PIN	COPPIGLIA	GOUPILLE	1	
			REC90430-08020	JUNTA DESAGÜE	DRAIN GASKET	DRAIN GASKET	GUARNIZIONE DRENAGGIO	JOINT DE VIDANGE	x 2	
			REC6AH-W0078-00	KIT BOMBA DE AGUA	WATER PUMP REPAIR KIT	WATER PUMP REPAIR KIT	KIT POMPA DELL'ACQUA	KIT POMPE À EAU	1	
			REC61N-24563-10	FILTRO COMBUSTIBLE	FUEL FILTER	FUEL FILTER	FILTRO COMBUSTIBILE	FILTRE	1	
	RECKITF20A	F20A (1998-09)	REC5GH-13440-00	FILTRO DE ACEITE	OIL FILTER	FILTRO OLIO	FILTRE D'HUILE	1		
			CM62Y-11325-00A	ANODO	ANODE	ANODE	ANODE	x 2		
			PAF15-07010009	ALOJAMIENTO DEL ANODO	SEAL ANODE	SEAL ANODE	ALLOGGIAMENTO ANODO	JOINT D'ANODE	x 2	
			PAJASOF40431-025	TÓRICA	O-RING	O-RING	O-RING	JOINT TORIQUE	1	
			REC40145	FILTRO COMBUSTIBLE	FUEL FILTER	FUEL FILTER	FILTRO COMBUSTIBILE	FILTRE ESSENCE	1	
			PAF4-04000030	MUELLE DEL TUBO DE COMBUSTIBLE	SPRING, FUEL PIPE	MOLLA TUBO COMBUSTIBILE	MOLLA TUBO COMBUSTIBILE	COLLIER TUYAU DE CARBURANT	x 2	
			CM6E0-45251-11A	ANODO	ANODE	ANODE	ANODO	ANODO	1	
			PAF15-04000003	ARANDELA	WHASER	WHASER	RONDELLA	RONDELLE	1	
			CM61N-45251-01A	ANODO	ANODE	ANODE	ANODO	ANODO	1	
			REC90430-08020	JUNTA DESAGÜE	DRAIN GASKET	DRAIN GASKET	GUARNIZIONE DRENAGGIO	JOINT DE VIDANGE	x 2	
	RECKITF20B	F20B (2007+)	PAGB/T91-1.6X12	PIN BLOQUEADOR	COTTER PIN	COPPIGLIA	GOUPILLE	1		
			NGKDP6EA-9	BUJÍA	SPARK PLUG	SPARK PLUG	CANDELE	BOUGIE	x 2	
			REC61N-W0078-11	KIT BOMBA DE AGUA	WATER PUMP REPAIR KIT	WATER PUMP REPAIR KIT	KIT POMPA DELL'ACQUA	KIT POMPE À EAU	1	
			PAF4-04070003	ANODO	ANODE	ANODE	ANODO	ANODO	x 3	
			REC6AH-12411-00	TERMOSTATO	THERMOSTAT	THERMOSTAT	TERMOSTATO	THERMOSTAT	1	
	PAF20-05000702	JUNTA	GASKET	GASKET	GUARNIZIONE	JOINT	1			
	CM15026A	ANODO	ANODE	ANODE	ANODO	ANODO	1			
	REC5GH-13440-60	FILTRO DE ACEITE	OIL FILTER	OIL FILTER	FILTRO OLIO	FILTRE D'HUILE	1			
	NGKDP6EB-9	BUJÍA	SPARK PLUG	SPARK PLUG	CANDELE	BOUGIE	x 2			
	REC61N-24563-10	FILTRO COMBUSTIBLE	FUEL FILTER	FUEL FILTER	FILTRO COMBUSTIBILE	FILTRE ESSENCE	1			
	REC93210-32738	TÓRICA	O-RING	O-RING	O-RING	JOINT TORIQUE	1			
	PAF15-04000003	ARANDELA	WHASER	WHASER	RONDELLA	RONDELLE	1			
	REC90430-08020	JUNTA DESAGÜE	DRAIN GASKET	DRAIN GASKET	GUARNIZIONE DRENAGGIO	JOINT DE VIDANGE	x 2			
	TEN01154AL	ANODO	ANODE	ANODE	ANODO	ANODO	1			
	REC6AH-W0078-00	KIT BOMBA DE AGUA	WATER PUMP REPAIR KIT	WATER PUMP REPAIR KIT	KIT POMPA DELL'ACQUA	KIT POMPE À EAU	1			

	KIT	REF							
	RECKITF25A	REC5GH-13440-00	FILTRO DE ACEITE	OIL FILTER	FILTRO OLIO	FILTRE À HUILE	1		
		PAF15-07000031	TERMOSTATO	THERMOSTAT	TERMOSTATO	THERMOSTAT	1		
		PAF15-07010022	JUNTA	GASKET	GUARNIZIONE	JOINT	1		
		CM62Y-11325-00A	ANODO	ANODE	ANODO	ANODO	x 3		
		PAF15-07010009	ALOJAMIENTO DEL ANODO	SEAL ANODE	ALLOGGIAMENTO ANODO	JOINT D'ANODE	x 2		
		REC61N-24563-10	FILTRO COMBUSTIBLE	FUEL FILTER	FILTRO COMBUSTIBILE	FILTRE ESSENCE	1		
		REC93210-32738	TÓRICA	O-RING	O-RING	JOINT TORIQUE	1		
		NGKDPR6EA-9	BUJÍA	SPARK PLUG	CANDELE	BOUGIE	x 2		
		CM6E0-45251-11A	ANODO	ANODE	ANODO	ANODO	1		
		PAF15-04000003	ARANDELA	WHASER	RONDELLA	RONDELLE	1		
		CM61N-45251-01A	ANODO	ANODE	ANODO	ANODO	1		
		REC90430-08020	JUNTA DESAGÜE	DRAIN GASKET	GUARNIZIONE DRENAGGIO	JOINT DE VIDANGE	x 2		
		PAGB/T91-1.6X12	PIN BLOQUEADOR	COTTER PIN	COPPIGLIA	GOUPILLE	1		
		REC61N-W0078-11	KIT BOMBA DE AGUA	WATER PUMP REPAIR KIT	KIT POMPA DELL'ACQUA	KIT POMPE À EAU	1		
			RECKITFT25B	REC5GH-13440-00	FILTRO DE ACEITE	OIL FILTER	FILTRO OLIO	FILTRE À HUILE	1
				PAF15-07000031	TERMOSTATO	THERMOSTAT	TERMOSTATO	THERMOSTAT	1
PAF15-07010022	JUNTA			GASKET	GUARNIZIONE	JOINT	1		
CM62Y-11325-00A	ANODO			ANODE	ANODO	ANODO	x 3		
PAF15-07010009	ALOJAMIENTO DEL ANODO			SEAL ANODE	ALLOGGIAMENTO ANODO	JOINT D'ANODE	x 2		
REC61N-24563-10	FILTRO COMBUSTIBLE			FUEL FILTER	FILTRO COMBUSTIBILE	FILTRE ESSENCE	1		
REC93210-32738	TÓRICA			O-RING	O-RING	JOINT TORIQUE	1		
NGKDPR6EA-9	BUJÍA			SPARK PLUG	CANDELE	BOUGIE	x 2		
CM6E0-45251-11A	ANODO			ANODE	ANODO	ANODO	1		
PAF15-04000003	ARANDELA			WHASER	RONDELLA	RONDELLE	1		
CM67C-45371-00A	ANODO			ANODE	ANODO	ANODO	1		
REC90430-08020	JUNTA DESAGÜE			DRAIN GASKET	GUARNIZIONE DRENAGGIO	JOINT DE VIDANGE	x 2		
PAGB/T91-1.6X12	PIN BLOQUEADOR			COTTER PIN	COPPIGLIA	GOUPILLE	1		
REC66T-W0078-00	KIT BOMBA DE AGUA			WATER PUMP REPAIR KIT	KIT POMPA DELL'ACQUA	KIT POMPE À EAU	1		
CM67C-45251-00A	ANODO			ANODE	ANODO	ANODO	1		
	RECKITF25G			PAF4-04070003	ANODO	ANODE	ANODO	ANODE	x 4
		REC6FM-12411-00	TERMOSTATO	THERMOSTAT	TERMOSTATO	THERMOSTAT	1		
		REC5GH-13440-60	FILTRO ACEITE	OIL FILTER	FILTRO OLIO	FILTRE À HUILE	1		
		NGKDPR6EB-9	BUJÍA	SPARK PLUG	CANDELE	BOUGIE	x 2		
		REC6D8-WS24A-00	FILTRO COMBUSTIBLE	FUEL FILTER	FILTRO COMBUSTIBILE	FILTRE ESSENCE	1		
		PAGB/T3452.1-32.5X1.8	TÓRICA	O-RING	O-RING	JOINT TORIQUE	1		
		PAF4-04000006	ARANDELA	WHASER	RONDELLA	RONDELLE	1		
		PAF15-04000003	ARANDELA	WHASER	RONDELLA	RONDELLE	1		
		CM6E5-45251-00A	ANODO	ANODE	ANODO	ANODE	1		
		CM664-45371-01A	ANODO	ANODE	ANODO	ANODE	1		
		REC90430-08020	JUNTA DESAGÜE	DRAIN GASKET	GUARNIZIONE DRENAGGIO	JOINT DE VIDANGE	x 2		
		PAF25-04050004	GOMA SELLO DE AGUA	DAMPER WATER PIPE	AMMORTIZZATORE, TUBO DELL'ACQUA	MANCHON TUYAU D'EAU	1		
		REC6L2-44352-00	TURBINA	IMPELLER	GIRANTE	TURBINE	1		
		PAF25-04050003	TÓRICA	O-RING	O-RING	JOINT TORIQUE	1		
		PAGB/T91-1.6X12	PIN BLOQUEADOR	COTTER PIN	COPPIGLIA	GOUPILLE	1		
			RECKITF25D	PAF15-07000031	TERMOSTATO	THERMOSTAT	TERMOSTATO	THERMOSTAT	1
PAF15-07010022	JUNTA			GASKET	GUARNIZIONE	JOINT	1		
PAF4-04070003	ANODO			ANODE	ANODO	ANODE	1		
REC5GH-13440-60	FILTRO ACEITE			OIL FILTER	FILTRO OLIO	FILTRE À HUILE	1		
CM6BL-11325-00A	ANODO			ANODE	ANODO	ANODE	x 2		
NGKDPR6EB-9	BUJÍA			SPARK PLUG	CANDELE	BOUGIE	x 2		
REC61N-24563-10	FILTRO COMBUSTIBLE			FUEL FILTER	FILTRO COMBUSTIBILE	FILTRE ESSENCE	1		
PAGB/T3452.1-32.5X1.8	TÓRICA			O-RING	O-RING	JOINT TORIQUE	1		
CM62Y-11325-00A	ANODO			ANODE	ANODO	ANODE	1		
PAF15-04000003	ARANDELA			WHASER	RONDELLA	RONDELLE	1		
REC90430-08020	JUNTA DESAGÜE			DRAIN GASKET	GUARNIZIONE DRENAGGIO	JOINT DE VIDANGE	x 2		
CM61N-45251-01A	ANODO			ANODE	ANODO	ANODE	1		
REC61N-W0078-11	KIT BOMBA DE AGUA			WATER PUMP REPAIR KIT	KIT POMPA DELL'ACQUA	KIT POMPE À EAU	1		
PAGB/T91-1.6X12	PIN BLOQUEADOR			COTTER PIN	COPPIGLIA	GOUPILLE	1		
	RECKITFT25F			PAF15-07000031	TERMOSTATO	THERMOSTAT	TERMOSTATO	THERMOSTAT	1
				PAF15-07010022	JUNTA	GASKET	GUARNIZIONE	JOINT	1
		PAF4-04070003	ANODO	ANODE	ANODO	ANODE	1		
		REC5GH-13440-60	FILTRO ACEITE	OIL FILTER	FILTRO OLIO	FILTRE À HUILE	1		
		CM6BL-11325-00A	ANODO	ANODE	ANODO	ANODE	x 2		
		NGKDPR6EB-9	BUJÍA	SPARK PLUG	CANDELE	BOUGIE	x 2		
		REC61N-24563-10	FILTRO COMBUSTIBLE	FUEL FILTER	FILTRO COMBUSTIBILE	FILTRE ESSENCE	1		
		PAGB/T3452.1-32.5X1.8	TÓRICA	O-RING	O-RING	JOINT TORIQUE	1		
		CM6E0-45251-11A	ANODO	ANODE	ANODO	ANODE	1		
		CM62Y-11325-00A	ANODO	ANODE	ANODO	ANODE	1		
		PAF15-04000003	ARANDELA	WHASER	RONDELLA	RONDELLE	1		
		REC90430-08020	JUNTA DESAGÜE	DRAIN GASKET	GUARNIZIONE DRENAGGIO	JOINT DE VIDANGE	x 2		
		CM67C-45371-00A	ANODO	ANODE	ANODO	ANODE	1		
		PAGB/T91-1.6X12	PIN BLOQUEADOR	COTTER PIN	COPPIGLIA	GOUPILLE	1		
		CM67C-45251-00A	ANODO	ANODE	ANODO	ANODE	1		
		REC66T-W0078-00	KIT BOMBA DE AGUA	WATER PUMP REPAIR KIT	KIT POMPA DELL'ACQUA	KIT POMPE À EAU	1		

	KIT	REF							
	RECKITF30A	PAF15-07000031	TERMOSTATO	THERMOSTAT	TERMOSTATO	THERMOSTAT	1		
		PAF15-07010022	JUNTA	GASKET	GUARNIZIONE	JOINT	1		
		NGKDPR6EA-9	BUJÍA	SPARK PLUG	CANDELE	BOUGIE	x 3		
		REC5GH-13440-00	FILTRO ACEITE	OIL FILTER	FILTRO OLIO	FILTRE À HUILE	1		
		CM62Y-11325-00A	ANODO	ANODE	ANODO	ANODE	x 4		
		PAF15-07010009	ALOJAMIENTO DEL ANODO	SEAL ANODE	ALLOGGIAMENTO ANODO	JOINT D'ANODE	x 4		
		REC40145	FILTRO COMBUSTIBLE	FUEL FILTER	FILTRO COMBUSTIBILE	FILTRE ESSENCE	1		
		PAF4-04000030	MUELLE DEL TUBO DE COMBUSTIBLE	SPRING, FUEL PIPE	MOLLA TUBO COMBUSTIBILE	COLLIER TUYAU DE CARBURANT	x 2		
		CM688-45251-01A	ANODO	ANODE	ANODO	ANODE	1		
		PAF15-04000003	ARANDELA	WHASER	RONDELLA	RONDELLE	1		
		REC90430-08020	JUNTA DESAGÜE	DRAIN GASKET	GUARNIZIONE DRENAGGIO	JOINT DE VIDANGE	x 2		
		CM67C-45251-00A	ANODO	ANODE	ANODO	ANODE	1		
		CM67C-45371-00A	ANODO	ANODE	ANODO	ANODE	1		
		REC91490-30025	PIN BLOQUEADOR	COTTER PIN	COPPIGLIA	GOUPILLE	1		
		REC66T-W0078-00	KIT BOMBA DE AGUA	WATER PUMP REPAIR KIT	KIT POMPA DELL'ACQUA	KIT POMPE À EAU	1		
			RECKITF30B	PAF15-07000031	TERMOSTATO	THERMOSTAT	TERMOSTATO	THERMOSTAT	1
				PAF15-07010022	JUNTA	GASKET	GUARNIZIONE	JOINT	1
PAF4-04070003	ANODO			ANODE	ANODO	ANODE	x 4		
REC5GH-13440-60	FILTRO DE ACEITE			OIL FILTER	FILTRO OLIO	FILTRE À HUILE	1		
NGKDPR6EB-9	BUJÍA			SPARK PLUG	CANDELE	BOUGIE	x 3		
REC6BG-13915-00	FILTRO COMBUSTIBLE VST			FUEL FILTER VST	FILTRO COMBUSTIBILE VST	FILTRE ESSENCE VST	1		
REC6C5-24251-00	FILTRO COMBUSTIBLE			FUEL FILTER	FILTRO COMBUSTIBILE	FILTRE ESSENCE	1		
REC6D8-WS24A-00	FILTRO COMBUSTIBLE			FUEL FILTER	FILTRO COMBUSTIBILE	FILTRE ESSENCE	1		
PAGB/T3452.1-32.5X1.8	TÓRICA			O-RING	O-RING	JOINT TORIQUE	1		
CM6E0-45251-11A	ANODO			ANODE	ANODO	ANODE	1		
CM688-45251-01A	ANODO			ANODE	ANODO	ANODE	1		
CM62Y-11325-00A	ANODO			ANODE	ANODO	ANODE	1		
PAF15-04000003	ARANDELA			WHASER	RONDELLA	RONDELLE	1		
REC90430-08020	JUNTA DESAGÜE			DRAIN GASKET	GUARNIZIONE DRENAGGIO	JOINT DE VIDANGE	x 2		
CM67C-45371-00A	ANODO			ANODE	ANODO	ANODE	1		
CM67C-45251-00A	ANODO			ANODE	ANODO	ANODE	1		
REC6BG-W0078-00	KIT BOMBA DE AGUA			WATER PUMP REPAIR KIT	KIT POMPA DELL'ACQUA	KIT POMPE À EAU	1		
REC91490-30025	PIN BLOQUEADOR	COTTER PIN	SPINOTTO	PIN	1				
	RECKITF40B	PAF15-07000031	TERMOSTATO	THERMOSTAT	TERMOSTATO	THERMOSTAT	1		
		PAF15-07010022	JUNTA	GASKET	GUARNIZIONE	JOINT	1		
		REC3FV-13440-00	FILTRO DE ACEITE	OIL FILTER	FILTRO OLIO	FILTRE À HUILE	1		
		CM62Y-11325-00A	ANODO	ANODE	ANODO	ANODE	x 3		
		PAF15-07010009	ALOJAMIENTO DEL ANODO	SEAL ANODE	ALLOGGIAMENTO ANODO	JOINT D'ANODE	x 3		
		NGKDPR6EA-9	BUJÍA	SPARK PLUG	CANDELE	BOUGIE	x 3		
		REC40145	FILTRO COMBUSTIBLE	FUEL FILTER	FILTRO COMBUSTIBILE	FILTRE ESSENCE	1		
		PAF4-04000030	MUELLE DEL TUBO DE COMBUSTIBLE	SPRING, FUEL PIPE	MOLLA TUBO COMBUSTIBILE	COLLIER TUYAU DE CARBURANT	x 2		
		CM688-45251-01A	ANODO	ANODE	ANODO	ANODE	1		
		CM6E0-45251-11A	ANODO	ANODE	ANODO	ANODE	1		
		PAF15-04000003	ARANDELA	WHASER	RONDELLA	RONDELLE	1		
		REC90430-08020	JUNTA DESAGÜE	DRAIN GASKET	GUARNIZIONE DRENAGGIO	JOINT DE VIDANGE	x 2		
		CM67C-45371-00A	ANODO	ANODE	ANODO	ANODE	1		
		CM67C-45251-00A	ANODO	ANODE	ANODO	ANODE	1		
		REC91490-30025	PIN BLOQUEADOR	COTTER PIN	COPPIGLIA	GOUPILLE	1		
		REC66T-W0078-00	KIT BOMBA DE AGUA	WATER PUMP REPAIR KIT	KIT POMPA DELL'ACQUA	KIT POMPE À EAU	1		
			RECKITF50A	PAF15-07000031	TERMOSTATO	THERMOSTAT	TERMOSTATO	THERMOSTAT	1
PAF15-07010022	JUNTA			GASKET	GUARNIZIONE	JOINT	1		
PAF4-04070003	ANODO			ANODE	ANODO	ANODO	x 4		
REC5GH-13440-60	FILTRO DE ACEITE			OIL FILTER	FILTRO OLIO	FILTRE À HUILE	1		
NGKDPR6EB-9	BUJÍA			SPARK PLUG	CANDELE	BOUGIE	x 4		
REC6BG-13915-00	FILTRO COMBUSTIBLE VST			FUEL FILTER VST	FILTRO COMBUSTIBILE VST	FILTRE VST	1		
REC6C5-24251-00	FILTRO COMBUSTIBLE			FUEL FILTER	FILTRO COMBUSTIBILE	FILTRE ESSENCE	1		
REC6D8-WS24A-00	FILTRO COMBUSTIBLE			FUEL FILTER	FILTRO COMBUSTIBILE	FILTRE ESSENCE	1		
PAGB/T3452.1-32.5X1.8	TÓRICA			O-RING	O-RING	JOINT TORIQUE	1		
CM6E0-45251-11A	ANODO			ANODE	ANODO	ANODE	1		
CM688-45251-01A	ANODO			ANODE	ANODO	ANODE	1		
CM62Y-11325-00A	ANODO			ANODE	ANODO	ANODE	1		
PAF15-04000003	ARANDELA			WHASER	RONDELLA	RONDELLE	1		
REC90430-08020	JUNTA DESAGÜE			DRAIN GASKET	GUARNIZIONE DRENAGGIO	JOINT DE VIDANGE	x 2		
CM67C-45371-00A	ANODO			ANODE	ANODO	ANODE	1		
CM67C-45251-00A	ANODO			ANODE	ANODO	ANODE	1		
REC6BG-W0078-00	KIT BOMBA DE AGUA			WATER PUMP REPAIR KIT	KIT POMPA DELL'ACQUA	KIT POMPE À EAU	1		
REC91490-30025	PIN BLOQUEADOR	COTTER PIN	COPPIGLIA	GOUPILLE	1				

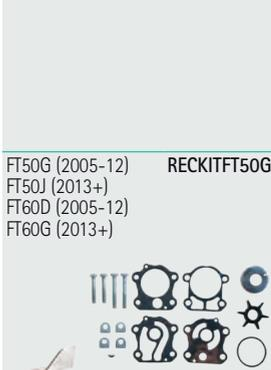
	KIT	REF					
	RECKITFT50B	PAF15-07000031	TERMOSTATO	THERMOSTAT	TERMOSTATO	THERMOSTAT	1
		PAF15-07010022	JUNTA	GASKET	GUARNIZIONE	JOINT	1
		REC5GH-13440-00	FILTRO DE ACEITE	OIL FILTER	FILTRO OLIO	FILTRE À HUILE	1
		CM62Y-11325-00A	ANODO	ANODE	ANODO	ANODE	x 5
		PAF15-07010009	ALOJAMIENTO DEL ANODO	SEAL ANODE	ALLOGGIAMENTO ANODO	JOINT D'ANODE	x 5
		NGKDP6EA-9	BUJÍA	SPARK PLUG	CANDELE	BOUGIE	x 4
		REC68V-24563-00	FILTRO COMBUSTIBLE	FUEL FILTER	FILTRO COMBUSTIBILE	FILTRE	1
		REC93210-32738	TÓRICA	O-RING	O-RING	JOINT TORIQUE	1
		CM6E0-45251-11A	ANODO	ANODE	ANODO	ANODE	x 3
		PAF15-04000003	ARANDELA	WHASER	RONDELLA	RONDELLE	1
		REC90430-08020	JUNTA DESAGÜE	DRAIN GASKET	GUARNIZIONE DRENAGGIO	JOINT DE VIDANGE	x 2
		CM67F-45371-00A	ANODO	ANODE	ANODO	ANODE	1
		REC91490-40030	PIN BLOQUEADOR	COTTER PIN	COPPIGLIA	GOUPILLE	1
		REC6H3-W0078-02	KIT BOMBA DE AGUA	WATER PUMP REPAIR KIT	KIT POMPA DELL'ACQUA	KIT POMPE À EAU	1
			RECKITFT50C	PAF15-07000031	TERMOSTATO	THERMOSTAT	TERMOSTATO
PAF15-07010022	JUNTA			GASKET	GUARNIZIONE	JOINT	1
CM62Y-11325-00A	ANODO			ANODE	ANODO	ANODE	x 5
PAF15-07010009	ALOJAMIENTO DEL ANODO			SEAL ANODE	ALLOGGIAMENTO ANODO	JOINT D'ANODE	x 5
NGKDP6EA-9	BUJÍA			SPARK PLUG	CANDELE	BOUGIE	x 4
REC5GH-13440-00	FILTRO DE ACEITE			OIL FILTER	FILTRO OLIO	FILTRE À HUILE	1
REC61N-24563-10	FILTRO COMBUSTIBLE			FUEL FILTER	FILTRO COMBUSTIBILE	FILTRE ESSENCE	1
PAGB/T3452.1-32.5X1.8	TÓRICA			O-RING	O-RING	JOINT TORIQUE	1
CM6E0-45251-11A	ANODO			ANODE	ANODO	ANODE	x 3
PAF15-04000003	ARANDELA			WHASER	RONDELLA	RONDELLE	1
REC90430-08020	JUNTA DESAGÜE			DRAIN GASKET	GUARNIZIONE DRENAGGIO	JOINT DE VIDANGE	x 2
CM67F-45371-00A	ANODO			ANODE	ANODO	ANODE	1
REC91490-40030	PIN BLOQUEADOR			COTTER PIN	COPPIGLIA	GOUPILLE	1
REC6H3-W0078-02	KIT BOMBA DE AGUA			WATER PUMP REPAIR KIT	KIT POMPA DELL'ACQUA	KIT POMPE À EAU	1
	RECKITF50F			PAF15-07000031	TERMOSTATO	THERMOSTAT	TERMOSTATO
		PAF15-07010022	JUNTA	GASKET	GUARNIZIONE	JOINT	1
		CM62Y-11325-00A	ANODO	ANODE	ANODO	ANODE	x 5
		PAF15-07010009	ALOJAMIENTO DEL ANODO	SEAL ANODE	ALLOGGIAMENTO ANODO	JOINT D'ANODE	x 5
		REC5GH-13440-00	FILTRO DE ACEITE	OIL FILTER	FILTRO OLIO	FILTRE À HUILE	1
		NGKDP6EB-9	BUJÍA	SPARK PLUG	CANDELE	BOUGIE	x 4
		REC6C5-13915-00	FILTRO COMBUSTIBLE VST	FUEL FILTER VST	FILTRO COMBUSTIBILE VST	FILTRE VST	1
		REC6C5-14984-00	TÓRICA VST	VST O-RING	O-RING VST	JOINT TORIQUE VST	1
		REC6C5-24251-00	FILTRO COMBUSTIBLE	FUEL FILTER	FILTRO COMBUSTIBILE	FILTRE ESSENCE	1
		REC68V-24563-00	FILTRO COMBUSTIBLE	FUEL FILTER	FILTRO COMBUSTIBILE	FILTRE ESSENCE	1
		REC93210-32738	TÓRICA	O-RING	O-RING	JOINT TORIQUE	1
		CM6E0-45251-11A	ANODO	ANODE	ANODO	ANODE	x 2
		CM688-45251-01A	ANODO	ANODE	ANODO	ANODE	1
		PAF15-04000003	ARANDELA	WHASER	RONDELLA	RONDELLE	1
		REC90430-08020	JUNTA DESAGÜE	DRAIN GASKET	GUARNIZIONE DRENAGGIO	JOINT DE VIDANGE	x 2
CM67C-45371-00A	ANODO	ANODE	ANODO	ANODE	1		
CM67C-45251-00A	ANODO	ANODE	ANODO	ANODE	1		
REC91490-30025	PIN BLOQUEADOR	COTTER PIN	COPPIGLIA	GOUPILLE	1		
REC63D-W0078-01	KIT BOMBA DE AGUA	WATER PUMP REPAIR KIT	KIT POMPA DELL'ACQUA	KIT POMPE À EAU	1		
	RECKITFT50G	PAF15-07000031	TERMOSTATO	THERMOSTAT	TERMOSTATO	THERMOSTAT	1
		PAF15-07010022	JUNTA	GASKET	GUARNIZIONE	JOINT	1
		REC5GH-13440-60	FILTRO DE ACEITE	OIL FILTER	FILTRO OLIO	FILTRE À HUILE	1
		CM62Y-11325-00A	ANODO	ANODE	ANODO	ANODE	1
		PAF15-07010009	ALOJAMIENTO DEL ANODO	SEAL ANODE	ALLOGGIAMENTO ANODO	JOINT D'ANODE	1
		NGKDP6EB-9	BUJÍA	SPARK PLUG	CANDELE	BOUGIE	x 4
		PAF4-04070003	ANODO	ANODE	ANODO	ANODE	x 4
		PAGB/T3452.1-13X2	TÓRICA	O-RING	O-RING	JOINT TORIQUE	x 4
		REC6C5-13915-00	FILTRO COMBUSTIBLE VST	FUEL FILTER VST	FILTRO COMBUSTIBILE VST	FILTRE ESSENCE VST	1
		REC6C5-14984-00	TÓRICA VST	VST O-RING	O-RING VST	JOINT TORIQUE VST	1
		REC6C5-24251-00	FILTRO COMBUSTIBLE	FUEL FILTER	FILTRO COMBUSTIBILE	FILTRE ESSENCE	1
		REC6D8-WS24A-00	FILTRO COMBUSTIBLE	FUEL FILTER	FILTRO COMBUSTIBILE	FILTRE ESSENCE	1
		PAGB/T3452.1-32.5X1.8	TÓRICA	O-RING	O-RING	JOINT TORIQUE	1
		CM6E0-45251-11A	ANODO	ANODE	ANODO	ANODE	x 3
		PAF15-04000003	ARANDELA	WHASER	RONDELLA	RONDELLE	1
REC90430-08020	JUNTA DESAGÜE	DRAIN GASKET	GUARNIZIONE DRENAGGIO	JOINT DE VIDANGE	x 2		
CM67F-45371-00A	ANODO	ANODE	ANODO	ANODE	1		
REC91490-40030	PIN BLOQUEADOR	COTTER PIN	COPPIGLIA	GOUPILLE	1		
REC6H3-W0078-02	KIT BOMBA DE AGUA	WATER PUMP REPAIR KIT	KIT POMPA DELL'ACQUA	KIT POMPE À EAU	1		

	KIT	REF								
F50H (2013+) F60A (2002-07) F60C (2005-12) F60F (2013+)		RECKITF60A	PAF15-07010009	ALOJAMIENTO DEL ANODO	SEAL ANODE	ALLOGGIAMENTO ANODO	JOINT D'ANODE	1		
		REC5GH-13440-60	FILTRO DE ACEITE	OIL FILTER	FILTRO OLIO	FILTRE À HUILE	1			
		PAF4-04070003	ANODO	ANODE	ANODO	ANODE	x 4			
		PAGB/T3452.1-13X2	TÓRICA	O-RING	O-RING	JOINT TORIQUE	x 4			
		NGKDPR6EB-9	BUJÍA	SPARK PLUG	CANDELE	BOUGIE	x 4			
		REC6C5-13915-00	FILTRO COMBUSTIBLE VST	FUEL FILTER VST	FILTRO COMBUSTIBILE VST	FILTRE VST	1			
		REC6C5-14984-00	TÓRICA VST	VST O-RING	O-RING VST	JOINT TORIQUE VST	1			
		REC6C5-24251-00	FILTRO COMBUSTIBLE	FUEL FILTER	FILTRO COMBUSTIBILE	FILTRE ESSENCE	1			
		REC6D8-WS24A-00	FILTRO COMBUSTIBLE	FUEL FILTER	FILTRO COMBUSTIBILE	FILTRE ESSENCE	1			
		REC93210-32738	TÓRICA	O-RING	O-RING	JOINT TORIQUE	1			
		CM6E0-45251-11A	ANODO	ANODE	ANODO	ANODE	x 4			
		CM688-45251-01A	ANODO	ANODE	ANODO	ANODE	1			
		PAF15-04000003	ARANDELA	WHASER	RONDELLA	RONDELLE	1			
		REC90430-08020	JUNTA DESAGÜE	DRAIN GASKET	GUARNIZIONE DRENAGGIO	JOINT DE VIDANGE	x 2			
		CM67C-45371-00A	ANODO	ANODE	ANODO	ANODE	1			
		CM67C-45251-00A	ANODO	ANODE	ANODO	ANODE	1			
REC91490-30025	PIN BLOQUEADOR	COTTER PIN	COPPIGLIA	GOUPILLE	1					
REC63D-W0078-01	KIT BOMBA DE AGUA	WATER PUMP REPAIR KIT	KIT POMPA DELL'ACQUA	KIT POMPE À EAU	1					
FT60B (2003-06)		RECKITF60B	PAF15-07000031	TERMOSTATO	THERMOSTAT	TERMOSTATO	THERMOSTAT	1		
		PAF15-07010022	JUNTA	GASKET	GUARNIZIONE	JOINT	1			
		CM62Y-11325-00A	ANODO	ANODE	ANODO	ANODE	x 5			
		PAF15-07010009	ALOJAMIENTO DEL ANODO	SEAL ANODE	ALLOGGIAMENTO ANODO	JOINT D'ANODE	x 5			
		REC5GH-13440-60	FILTRO DE ACEITE	OIL FILTER	FILTRO OLIO	FILTRE À HUILE	1			
		NGKDPR5EA-9	BUJÍA	SPARK PLUG	CANDELE	BOUGIE	x 4			
		REC61N-24563-10	FILTRO COMBUSTIBLE	FUEL FILTER	FILTRO COMBUSTIBILE	FILTRE ESSENCE	1			
		PAGB/T3452.1-32.5X1.8	TÓRICA	O-RING	O-RING	JOINT TORIQUE	1			
		CM6E0-45251-11A	ANODO	ANODE	ANODO	ANODE	x 3			
		PAF15-04000003	ARANDELA	WHASER	RONDELLA	RONDELLE	1			
		REC90430-08020	JUNTA DESAGÜE	DRAIN GASKET	GUARNIZIONE DRENAGGIO	JOINT DE VIDANGE	x 2			
		CM67F-45371-00A	ANODO	ANODE	ANODO	ANODE	1			
		REC91490-40030	PIN BLOQUEADOR	COTTER PIN	COPPIGLIA	GOUPILLE	1			
		REC6H3-W0078-02	KIT BOMBA DE AGUA	WATER PUMP REPAIR KIT	KIT POMPA DELL'ACQUA	KIT POMPE À EAU	1			
		F70A (2011+)		RECKITF70A	PAF15-07000031	TERMOSTATO	THERMOSTAT	TERMOSTATO	THERMOSTAT	1
				PAF15-07010022	JUNTA	GASKET	GUARNIZIONE	JOINT	1	
CM62Y-11325-00A	ANODO			ANODE	ANODO	ANODE	1			
REC5GH-13440-60	FILTRO DE ACEITE			OIL FILTER	FILTRO OLIO	FILTRE À HUILE	1			
PAF4-04070003	ANODO			ANODE	ANODO	ANODE	x 3			
PAGB/T3452.1-13X2	TÓRICA			O-RING	O-RING	JOINT TORIQUE	x 3			
NGKLR7E	BUJÍA			SPARK PLUG	CANDELE	BOUGIE	x 4			
REC6C5-13915-00	FILTRO COMBUSTIBLE VST			FUEL FILTER VST	FILTRO COMBUSTIBILE VST	FILTRE ESSENCE VST	1			
REC6C5-24251-00	FILTRO COMBUSTIBLE			FUEL FILTER	FILTRO COMBUSTIBILE	FILTRE ESSENCE	1			
REC6D8-WS24A-00	FILTRO COMBUSTIBLE			FUEL FILTER	FILTRO COMBUSTIBILE	FILTRE ESSENCE	1			
REC93210-32738	TÓRICA			O-RING	O-RING	JOINT TORIQUE	1			
CM6E0-45251-11A	ANODO			ANODE	ANODO	ANODE	x 3			
PAF15-04000003	ARANDELA			WHASER	RONDELLA	RONDELLE	1			
REC90430-08020	JUNTA DESAGÜE			DRAIN GASKET	GUARNIZIONE DRENAGGIO	JOINT DE VIDANGE	x 2			
CM67F-45371-00A	ANODO			ANODE	ANODO	ANODE	1			
REC91490-30025	PIN BLOQUEADOR			COTTER PIN	COPPIGLIA	GOUPILLE	1			
REC6CJ-W0078-00	KIT BOMBA DE AGUA	WATER PUMP REPAIR KIT	KIT POMPA DELL'ACQUA	KIT POMPE À EAU	1					
F80A (2000-07) F100A (1997-07)		RECKITF80A	CM68V-11325-01A	ANODO	ANODE	ANODO	ANODE	x 2		
		REC5GH-13440-00	FILTRO DE ACEITE	OIL FILTER	FILTRO OLIO	FILTRE À HUILE	1			
		REC67F-12411-01	TERMOSTATO	THERMOSTAT	TERMOSTATO	THERMOSTAT	1			
		NGKLR5A-11	BUJÍA	SPARK PLUG	CANDELE	BOUGIE	x 4			
		PAJASOF40431-025	TÓRICA	O-RING	O-RING	JOINT TORIQUE	1			
		REC61N-24563-10	FILTRO COMBUSTIBLE	FUEL FILTER	FILTRO COMBUSTIBILE	FILTRE ESSENCE	1			
		PAGB/T3452.1-32.5X1.8	TÓRICA	O-RING	O-RING	JOINT TORIQUE	1			
		CM6H1-45251-02A	ANODO	ANODE	ANODO	ANODE	1			
		PAF15-04000003	ARANDELA	WHASER	RONDELLA	RONDELLE	1			
		REC91490-40030	PIN BLOQUEADOR	COTTER PIN	COPPIGLIA	GOUPILLE	1			
		REC90430-08020	JUNTA DESAGÜE	DRAIN GASKET	GUARNIZIONE DRENAGGIO	JOINT DE VIDANGE	x 2			
		REC67F-W0078-00	KIT BOMBA DE AGUA	WATER PUMP REPAIR KIT	KIT POMPA DELL'ACQUA	KIT POMPE À EAU	1			

	KIT	REF					
	RECKITF80B	CM15026A	ANODO	ANODE	ANODO	ANODE	x 3
		CM67F-11325-01A	ANODO	ANODE	ANODO	ANODE	1
		REC5GH-13440-00	FILTRO DE ACEITE	OIL FILTER	FILTRO OLIO	FILTRE À HUILE	1
		CM67F-11325-01A	ANODO	ANODE	ANODO	ANODE	x 2
		PAJASOF40431-025	TÓRICA	O-RING	O-RING	JOINT TORIQUE	1
		REC67F-12411-01	TERMOSTATO	THERMOSTAT	TERMOSTATO	THERMOSTAT	1
		NGKLF5A-11	BUJÍA	SPARK PLUG	CANDELE	BOUGIE	x 4
		REC6C5-13915-00	FILTRO COMBUSTIBLE	FUEL FILTER	FILTRO COMBUSTIBILE	FILTRE ESSENCE	1
		REC6C5-24251-00	FILTRO COMBUSTIBLE	FUEL FILTER	FILTRO COMBUSTIBILE	FILTRE ESSENCE	1
		REC6D8-WS24A-00	FILTRO COMBUSTIBLE	FUEL FILTER	FILTRO COMBUSTIBILE	FILTRE ESSENCE	1
		PAGB/T3452.1-32.5X1.8	TÓRICA	O-RING	O-RING	JOINT TORIQUE	1
		CM6H1-45251-02A	ANODO	ANODE	ANODO	ANODE	1
		PAF15-04000003	ARANDELA	WHASER	RONDELLA	RONDELLE	1
		REC90430-08020	JUNTA DESAGÜE	DRAIN GASKET	GUARNIZIONE DRENAGGIO	JOINT DE VIDANGE	x 2
		CM67F-45371-00	ANODO	ANODE	ANODO	ANODE	1
		REC91490-40030	PIN BLOQUEADOR	COTTER PIN	COPPIGLIA	GOUPILLE	1
		REC67F-W0078-00	KIT BOMBA DE AGUA	WATER PUMP REPAIR KIT	KIT POMPA DELL'ACQUA	KIT POMPE À EAU	1
	RECKITF100D	CM15026A	ANODO	ANODE	ANODO	ANODE	x 3
		REC5GH-13440-00	FILTRO DE ACEITE	OIL FILTER	FILTRO OLIO	FILTRE À HUILE	1
		CM67F-11325-01A	ANODO	ANODE	ANODO	ANODE	x 3
		PAJASOF40431-025	TÓRICA	O-RING	O-RING	JOINT TORIQUE	1
		REC6D9-12411-00	TERMOSTATO	THERMOSTAT	TERMOSTATO	THERMOSTAT	1
		NGKLF5A-11	BUJÍA	SPARK PLUG	CANDELE	BOUGIE	x 4
		REC6C5-13915-00	FILTRO COMBUSTIBLE	FUEL FILTER	FILTRO COMBUSTIBILE	FILTRE ESSENCE	1
		REC6C5-24251-00	FILTRO COMBUSTIBLE	FUEL FILTER	FILTRO COMBUSTIBILE	FILTRE ESSENCE	1
		REC6D8-WS24A-00	FILTRO COMBUSTIBLE	FUEL FILTER	FILTRO COMBUSTIBILE	FILTRE ESSENCE	1
		PAGB/T3452.1-32.5X1.8	TÓRICA	O-RING	O-RING	JOINT TORIQUE	1
		CM6H1-45251-02A	ANODO	ANODE	ANODO	ANODE	1
		PAF15-04000003	ARANDELA	WHASER	RONDELLA	RONDELLE	1
		REC90430-08020	JUNTA DESAGÜE	DRAIN GASKET	GUARNIZIONE DRENAGGIO	JOINT DE VIDANGE	x 2
		CM67F-45371-00	ANODO	ANODE	ANODO	ANODE	1
		REC91490-40030	PIN BLOQUEADOR	COTTER PIN	SPINOTTO	PIN	1
		REC67F-W0078-00	KIT BOMBA DE AGUA	WATER PUMP REPAIR KIT	KIT POMPA DELL'ACQUA	KIT POMPE À EAU	1
			RECKITF100F	PAF4-04070003	ANODO	ANODE	ANODO
PAGB/T3452.1-13X2	TÓRICA			O-RING	O-RING	JOINT TORIQUE	x 4
CM63P-11325-01A	ANODO			ANODE	ANODO	ANODE	1
REC5GH-13440-00	FILTRO DE ACEITE			OIL FILTER	FILTRO OLIO	FILTRE À HUILE	1
REC6FP-12411-00	TERMOSTATO			THERMOSTAT	TERMOSTATO	THERMOSTAT	1
NGKLR6E-9N	BUJÍA			SPARK PLUG	CANDELE	BOUGIE	x 4
TENO1165	ANODO			ANODE	ANODO	ANODE	1
REC6C5-24251-00	FILTRO COMBUSTIBLE			FUEL FILTER	FILTRO COMBUSTIBILE	FILTRE ESSENCE	1
REC6D8-WS24A-00	FILTRO COMBUSTIBLE			FUEL FILTER	FILTRO COMBUSTIBILE	FILTRE ESSENCE	1
PAGB/T3452.1-32.5X1.8	TÓRICA			O-RING	O-RING	JOINT TORIQUE	1
CM6H1-45251-02A	ANODO			ANODE	ANODO	ANODE	1
PAF15-04000003	ARANDELA			WHASER	RONDELLA	RONDELLE	1
REC90430-08020	JUNTA DESAGÜE			DRAIN GASKET	GUARNIZIONE DRENAGGIO	JOINT DE VIDANGE	x 2
CM6E5-45371-01A	ANODO			ANODE	ANODO	ANODE	1
REC91490-40030	PIN BLOQUEADOR			COTTER PIN	COPPIGLIA	GOUPILLE	1
REC68V-W0078-00	KIT BOMBA DE AGUA			WATER PUMP REPAIR KIT	KIT POMPA DELL'ACQUA	KIT POMPE À EAU	1
	RECKITF115A			CM15026A	ANODO	ANODE	ANODO
		REC5GH-13440-00	FILTRO DE ACEITE	OIL FILTER	FILTRO OLIO	FILTRE À HUILE	1
		CM67F-11325-01A	ANODO	ANODE	ANODO	ANODE	x 3
		REC60V-12411-00	TERMOSTATO	THERMOSTAT	TERMOSTATO	THERMOSTAT	1
		NGKLF6A-11	BUJÍA	SPARK PLUG	CANDELE	BOUGIE	x 4
		REC6CB-24501-01	FILTRO COMBUSTIBLE	FUEL FILTER	FILTRO COMBUSTIBILE	FILTRE ESSENCE	1
		REC6CB-13016-00	TÓRICA	O-RING	O-RING	JOINT TORIQUE	1
		REC63P-13915-00	FILTRO COMBUSTIBLE	FUEL FILTER	FILTRO COMBUSTIBILE	FILTRE ESSENCE	1
		REC6CB-14984-00	TÓRICA	O-RING	O-RING	JOINT TORIQUE	1
		CM6G5-45251-01A	ANODO	ANODE	ANODO	ANODE	1
		REC6D8-WS24A-00	FILTRO COMBUSTIBLE	FUEL FILTER	FILTRO COMBUSTIBILE	FILTRE ESSENCE	1
		PAGB/T3452.1-32.5X1.8	TÓRICA	O-RING	O-RING	JOINT TORIQUE	1
		PAF15-04000003	ARANDELA	WHASER	RONDELLA	RONDELLE	1
		REC90430-08020	JUNTA DESAGÜE	DRAIN GASKET	GUARNIZIONE DRENAGGIO	JOINT DE VIDANGE	x 2
		CM6E5-45371-01A	ANODO	ANODE	ANODO	ANODE	1
		REC91490-40030	PIN BLOQUEADOR	COTTER PIN	COPPIGLIA	GOUPILLE	1
		REC68V-W0078-00	KIT BOMBA DE AGUA	WATER PUMP REPAIR KIT	KIT POMPA DELL'ACQUA	KIT POMPE À EAU	1



	KIT	REF								
	RECKITF115B	PAF4-04070003	ANODO	ANODE	ANODO	ANODE	x 3			
		F115B (2014+)	PAGB/T3452.1-13X2	TÓRICA	O-RING	O-RING	JOINT TORIQUE	x 3		
		F130A (2015+)	CM63P-11325-01A	ANODO	ANODE	ANODO	ANODE	1		
			REC5GH-13440-00	FILTRO DE ACEITE	OIL FILTER	FILTRO OLIO	FILTRE À HUILE	1		
			CM67F-11325-01A	ANODO	ANODE	ANODO	ANODE	1		
			NGKLR6E	BUJÍA	SPARK PLUG	CANDELE	BOUGIE	x 4		
			REC6CB-13016-00	TÓRICA	O-RING	O-RING	JOINT TORIQUE	1		
			REC63P-13915-00	FILTRO COMBUSTIBLE	FUEL FILTER	FILTRO COMBUSTIBILE	FILTRE ESSENCE	1		
			REC6CB-14984-00	TÓRICA	O-RING	O-RING	JOINT TORIQUE	1		
			REC6D8-WS24A-00	FILTRO COMBUSTIBLE	FUEL FILTER	FILTRO COMBUSTIBILE	FILTRE ESSENCE	1		
			PAGB/T3452.1-32.5X1.8	TÓRICA	O-RING	O-RING	JOINT TORIQUE	1		
			CM6H1-45251-02A	ANODO	ANODE	ANODO	ANODE	1		
			PAF15-04000003	ARANDELA	WHASER	RONDELLA	RONDELLE	1		
			REC90430-08020	JUNTA DESAGÜE	DRAIN GASKET	GUARNIZIONE DRENAGGIO	JOINT DE VIDANGE	x 2		
			CM6E5-45371-01A	ANODO	ANODE	ANODO	ANODE	1		
			REC91490-40030	PIN BLOQUEADOR	COTTER PIN	COPPIGLIA	GOUPILLE	1		
			REC68V-W0078-00	KIT BOMBA DE AGUA	WATER PUMP REPAIR KIT	KIT POMPA DELL'ACQUA	KIT POMPE À EAU	1		
			RECKITF150RR	CM63P-11325-11A	ANODO	ANODE	ANODO	ANODE	x 4	
				F150A (2003+)	CM63P-11325-01A	ANODO	ANODE	ANODO	ANODE	1
				F150B (2012+)	CM67F-11325-01A	ANODO	ANODE	ANODO	ANODE	x 3
F150D (2015+)	NGKLF5A-11			BUJÍA	SPARK PLUG	CANDELE	BOUGIE	x 4		
F150F (2015+)	CM68T-11325-00A			ANODO	ANODE	ANODO	ANODE	x 8		
REGULAR ROTATION	REC67F-12411-01			TERMOSTATO	THERMOSTAT	TERMOSTATO	THERMOSTAT	1		
	REC63P-12414-00			JUNTA	GASKET	GUARNIZIONE	JOINT	1		
	REC35-822626Q15			FILTRO DE ACEITE	OIL FILTER	FILTRO OLIO	FILTRE À HUILE	1		
	REC63P-14984-00			TÓRICA VST	VST O-RING	O-RING VST	JOINT TORIQUE VST	1		
	REC63P-13915-00			FILTRO COMBUSTIBLE	FUEL FILTER	FILTRO COMBUSTIBILE	FILTRE ESSENCE	1		
	REC65L-24563-00			FILTRO COMBUSTIBLE	FUEL FILTER	FILTRO COMBUSTIBILE	FILTRE ESSENCE	1		
	REC69J-24501-10			FILTRO COMBUSTIBLE	FUEL FILTER	FILTRO COMBUSTIBILE	FILTRE ESSENCE	1		
	REC6P3-WS24A-00			FILTRO COMBUSTIBLE	FUEL FILTER	FILTRO COMBUSTIBILE	FILTRE ESSENCE	1		
	REC6P3-24564-00			TÓRICA	O-RING	O-RING	JOINT TORIQUE	1		
	PAF15-04000003			ARANDELA	WHASER	RONDELLA	RONDELLE	1		
	REC90430-08020			JUNTA DESAGÜE	DRAIN GASKET	GUARNIZIONE DRENAGGIO	JOINT DE VIDANGE	x 2		
	REC61A-W0078-A1			KIT BOMBA DE AGUA	WATER PUMP REPAIR KIT	KIT POMPA DELL'ACQUA	KIT POMPE À EAU	1		
	REC91490-40030			PIN BLOQUEADOR	COTTER PIN	COPPIGLIA	GOUPILLE	1		
	CMY150KITA			KIT ÁNODOS	KIT ANODES	KIT ANODI	KIT ANODES	1		
	RECKITF150CR			TEN01165	ANODO	ANODE	ANODO	ANODE	1	
		F150A (2003+)	CM63P-11325-11A	ANODO	ANODE	ANODO	ANODE	x 4		
		F150B (2012+)	CM63P-11325-01A	ANODO	ANODE	ANODO	ANODE	1		
		F150D (2015+)	CM67F-11325-01A	ANODO	ANODE	ANODO	ANODE	x 3		
		F150F (2015+)	NGKLF5A-11	BUJÍA	SPARK PLUG	CANDELE	BOUGIE	x 4		
		COUNTER ROTATION	CM68T-11325-00A	ANODO	ANODE	ANODO	ANODE	x 8		
			REC67F-12411-01	TERMOSTATO	THERMOSTAT	TERMOSTATO	THERMOSTAT	1		
			REC63P-12414-00	JUNTA	GASKET	GUARNIZIONE	JOINT	1		
			REC35-822626Q15	FILTRO DE ACEITE	OIL FILTER	FILTRO OLIO	FILTRE À HUILE	1		
			REC63P-14984-00	TÓRICA VST	VST O-RING	O-RING VST	JOINT TORIQUE VST	1		
			REC63P-13915-00	FILTRO COMBUSTIBLE	FUEL FILTER	FILTRO COMBUSTIBILE	FILTRE ESSENCE	1		
			REC65L-24563-00	FILTRO COMBUSTIBLE	FUEL FILTER	FILTRO COMBUSTIBILE	FILTRE ESSENCE	1		
			REC69J-24501-10	FILTRO COMBUSTIBLE	FUEL FILTER	FILTRO COMBUSTIBILE	FILTRE ESSENCE	1		
			REC6P3-WS24A-00	FILTRO COMBUSTIBLE	FUEL FILTER	FILTRO COMBUSTIBILE	FILTRE ESSENCE	1		
			REC6P3-24564-00	TÓRICA	O-RING	O-RING	JOINT TORIQUE	1		
			PAF15-04000003	ARANDELA	WHASER	RONDELLA	RONDELLE	1		
			REC90430-08020	JUNTA DESAGÜE	DRAIN GASKET	GUARNIZIONE DRENAGGIO	JOINT DE VIDANGE	x 2		
			REC61A-W0078-A1	KIT BOMBA DE AGUA	WATER PUMP REPAIR KIT	KIT POMPA DELL'ACQUA	KIT POMPE À EAU	1		
			REC91490-40030	PIN BLOQUEADOR	COTTER PIN	COPPIGLIA	GOUPILLE	1		
			CMY150CRKITA	KIT ÁNODOS	KIT ANODES	KIT ANODI	KIT ANODES	1		

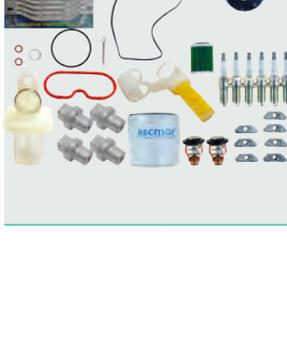

	KIT	REF								
	RECKITF150G	F150G (2017+)	CM67F-11325-01A	ANODO	ANODE	ANODO	ANODE	x 3		
		F175A (2014+)	CM15026A	ANODO	ANODE	ANODO	ANODE	x 2		
		F175C (2017+)	CM68T-11325-00A	ANODO	ANODE	ANODO	ANODE	x 2		
		F200F (2013+)	REC6DA-12411-01	TERMOSTATO	THERMOSTAT	TERMOSTATO	THERMOSTAT	1		
		F200G (2013+)	PAF15-04000003	ARANDELA	WHASER	RONDELLA	RONDELLE	1		
			REC35-822626Q15	FILTRO DE ACEITE	OIL FILTER	FILTRO OLIO	FILTRE À HUILE	1		
			REC6CB-24501-01	FILTRO COMBUSTIBLE	FUEL FILTER	FILTRO COMBUSTIBILE	FILTRE ESSENCE	1		
			REC6CB-13016-00	TÓRICA	O-RING	O-RING	JOINT TORIQUE	1		
			REC63P-13915-00	FILTRO COMBUSTIBLE	FUEL FILTER	FILTRO COMBUSTIBILE	FILTRE ESSENCE	1		
			REC6CB-14984-00	TÓRICA	O-RING	O-RING	JOINT TORIQUE	1		
			REC6P3-WS24A-00	FILTRO COMBUSTIBLE	FUEL FILTER	FILTRO COMBUSTIBILE	FILTRE ESSENCE	1		
			REC6P3-24564-00	TÓRICA	O-RING	O-RING	JOINT TORIQUE	1		
			CM6AW-45251-00A	ANODO	ANODE	ANODO	ANODE	1		
			REC90430-08020	JUNTA DESAGÜE	DRAIN GASKET	GUARNIZIONE DRENAGGIO	JOINT DE VIDANGE	x 2		
			CM6J9-45371-01A	ANODO	ANODE	ANODO	ANODE	1		
			NGKLF6A-11	BUJÍA	SPARK PLUG	CANDELE	BOUGIE	x 4		
			REC61A-W0078-A1	KIT BOMBA DE AGUA	WATER PUMP REPAIR KIT	KIT POMPA DELL'ACQUA	KIT POMPE À EAU	1		
	REC91490-40030	PIN BLOQUEADOR	COTTER PIN	COPPIGLIA	GOUPILLE	1				
	CM6K1-45371-02A	ANODO	ANODE	ANODO	ANODE	1				
	RECKITF200A	F200A (2002-07)	REC67F-12411-01	TERMOSTATO	THERMOSTAT	TERMOSTATO	THERMOSTAT	x 2		
		F225A (2002-07)	REC35-822626Q15	FILTRO DE ACEITE	OIL FILTER	FILTRO OLIO	FILTRE À HUILE	1		
			CM15026A	ANODO	ANODE	ANODO	ANODE	x 4		
			TEN01156	ANODO	ANODE	ANODO	ANODE	x 2		
			NGKLF5A-11	BUJÍA	SPARK PLUG	CANDELE	BOUGIE	x 6		
			CM67F-11325-01A	ÁNODO	ANODE	ANODO	ANODE	x 4		
			REC65L-24563-00	FILTRO COMBUSTIBLE	FUEL FILTER	FILTRO COMBUSTIBILE	FILTRE ESSENCE	1		
			REC68V-14984-00	TÓRICA VST	VST O-RING	O-RING VST	JOINT TORIQUE VST	1		
			REC68V-13915-00	FILTRO COMBUSTIBLE	FUEL FILTER	FILTRO COMBUSTIBILE	FILTRE ESSENCE	1		
			REC69J-24501-10	FILTRO COMBUSTIBLE	FUEL FILTER	FILTRO COMBUSTIBILE	FILTRE ESSENCE	1		
			REC6P3-WS24A-00	FILTRO COMBUSTIBLE	FUEL FILTER	FILTRO COMBUSTIBILE	FILTRE ESSENCE	1		
			REC6P3-24564-00	TÓRICA	O-RING	O-RING	JOINT TORIQUE	1		
			PAF15-04000003	ARANDELA	WHASER	RONDELLA	RONDELLE	1		
			CMY200250KITA	KIT ÁNODOS	KIT ANODES	KIT ANODI	KIT ANODES	1		
			REC90430-08020	JUNTA DESAGÜE	DRAIN GASKET	GUARNIZIONE DRENAGGIO	JOINT DE VIDANGE	x 2		
			REC91490-40030	PIN BLOQUEADOR	COTTER PIN	COPPIGLIA	GOUPILLE	1		
			REC61A-W0078-A1	KIT BOMBA DE AGUA	WATER PUMP REPAIR KIT	KIT POMPA DELL'ACQUA	KIT POMPE À EAU	1		
	RECKITF200C	F200C (2006-12)	CM15026A	ANODO	ANODE	ANODO	ANODE	x 6		
			REC67F-12411-01	TERMOSTATO	THERMOSTAT	TERMOSTATO	THERMOSTAT	x 2		
			REC35-822626Q15	FILTRO DE ACEITE	OIL FILTER	FILTRO OLIO	FILTRE À HUILE	1		
			TEN01156	ANODO	ANODE	ANODO	ANODE	x 2		
			NGKLF6A-11	BUJÍA	SPARK PLUG	CANDELE	BOUGIE	x 6		
			REC63P-13915-00	FILTRO COMBUSTIBLE	FUEL FILTER	FILTRO COMBUSTIBILE	FILTRE ESSENCE	1		
			REC6P2-14984-00	TÓRICA VST	VST O-RING	O-RING VST	JOINT TORIQUE VST	1		
			REC69J-24501-10	FILTRO COMBUSTIBLE	FUEL FILTER	FILTRO COMBUSTIBILE	FILTRE ESSENCE	1		
			REC6P3-WS24A-00	FILTRO COMBUSTIBLE	FUEL FILTER	FILTRO COMBUSTIBILE	FILTRE ESSENCE	1		
			REC6P3-24564-00	TÓRICA	O-RING	O-RING	JOINT TORIQUE	1		
			PAF15-04000003	ARANDELA	WHASER	RONDELLA	RONDELLE	1		
			REC91490-40030	PIN BLOQUEADOR	COTTER PIN	COPPIGLIA	GOUPILLE	1		
			REC90430-08020	JUNTA DESAGÜE	DRAIN GASKET	GUARNIZIONE DRENAGGIO	JOINT DE VIDANGE	x 2		
			CMY200250KITA	KIT ÁNODOS	KIT ANODES	KIT ANODI	KIT ANODES	1		
			REC61A-W0078-A1	KIT BOMBA DE AGUA	WATER PUMP REPAIR KIT	KIT POMPA DELL'ACQUA	KIT POMPE À EAU	1		
			RECKITF225B	F225B (2012+)	CM15026A	ANODO	ANODE	ANODO	ANODE	x 7
				F200C (2012+)	REC67F-12411-01	TERMOSTATO	THERMOSTAT	TERMOSTATO	THERMOSTAT	x 2
	REC35-822626Q15			FILTRO DE ACEITE	OIL FILTER	FILTRO OLIO	FILTRE À HUILE	1		
	CM67F-11325-01A			ÁNODO	ANODE	ANODO	ANODE	x 4		
	NGKLF6A-11			BUJÍA	SPARK PLUG	CANDELE	BOUGIE	x 6		
	REC6CB-24501-01			FILTRO COMBUSTIBLE	FUEL FILTER	FILTRO COMBUSTIBILE	FILTRE ESSENCE	1		
	REC6CB-13016-00			TÓRICA	O-RING	O-RING	JOINT TORIQUE	1		
	REC63P-13915-00			FILTRO COMBUSTIBLE	FUEL FILTER	FILTRO COMBUSTIBILE	FILTRE ESSENCE	1		
	REC6P2-14984-00			TÓRICA VST	VST O-RING	O-RING VST	JOINT TORIQUE VST	1		
	REC6P3-WS24A-00			FILTRO COMBUSTIBLE	FUEL FILTER	FILTRO COMBUSTIBILE	FILTRE ESSENCE	1		
	REC6P3-24564-00			TÓRICA	O-RING	O-RING	JOINT TORIQUE	1		
	PAF15-04000003			ARANDELA	WHASER	RONDELLA	RONDELLE	1		
	REC91490-40030			PIN BLOQUEADOR	COTTER PIN	COPPIGLIA	GOUPILLE	1		
	REC90430-08020			JUNTA DESAGÜE	DRAIN GASKET	GUARNIZIONE DRENAGGIO	JOINT DE VIDANGE	x 2		
	CMY200250KITA			KIT ÁNODOS	KIT ANODES	KIT ANODI	KIT ANODES	1		
	REC61A-W0078-A1			KIT BOMBA DE AGUA	WATER PUMP REPAIR KIT	KIT POMPA DELL'ACQUA	KIT POMPE À EAU	1		

	KIT	REF								
	RECKITF225C	F225C (2009-15)	CM15026A	ANODO	ANODE	ANODO	ANODE	x 7		
		F250A (2006-13)	REC67F-12411-01	TERMOSTATO	THERMOSTAT	TERMOSTATO	THERMOSTAT	x 2		
			REC35-822626Q15	FILTRO DE ACEITE	OIL FILTER	FILTRO OLIO	FILTRE À HUILE	1		
			CM67F-11325-01A	ANODO	ANODE	ANODO	ANODE	x 4		
			NGKLF6A-11	BUJÍA	SPARK PLUG	CANDELE	BOUGIE	x 6		
			REC6CB-24501-01	FILTRO COMBUSTIBLE	FUEL FILTER	FILTRO COMBUSTIBILE	FILTRE ESSENCE	1		
			REC6CB-13016-00	TÓRICA	O-RING	O-RING	JOINT TORIQUE	1		
			REC63P-13915-00	FILTRO COMBUSTIBLE	FUEL FILTER	FILTRO COMBUSTIBILE	FILTRE ESSENCE	1		
			REC6P2-14984-00	TÓRICA VST	VST O-RING	O-RING VST	JOINT TORIQUE VST	1		
			REC6P3-WS24A-00	FILTRO COMBUSTIBLE	FUEL FILTER	FILTRO COMBUSTIBILE	FILTRE ESSENCE	1		
			REC6P3-24564-00	TÓRICA	O-RING	O-RING	JOINT TORIQUE	1		
			PAF15-04000003	ARANDELA	WHASER	RONDELLA	RONDELLE	1		
			REC91490-40030	PIN BLOQUEADOR	COTTER PIN	COPPIGLIA	GOUPILLE	1		
			REC90430-08020	JUNTA DESAGÜE	DRAIN GASKET	GUARNIZIONE DRENAGGIO	JOINT DE VIDANGE	x 2		
			CMY200250KITA	KIT ÁNODOS	KIT ANODES	KIT ANODI	KIT ANODES	1		
			REC6P2-W0078-00	KIT BOMBA DE AGUA	WATER PUMP REPAIR KIT	KIT POMPA DELL'ACQUA	KIT POMPE À EAU	1		
			RECKITF250D	F225F (2011+)	REC6CE-12411-00	TERMOSTATO	THERMOSTAT	TERMOSTATO	THERMOSTAT	x 2
				F225B (2009+)	TEN01177	ANODO	ANODE	ANODO	ANODE	x 4
F250D (2011+)	CM68T-11325-00A			ANODO	ANODE	ANODO	ANODE	x 2		
F300B (2011+)	TEN01171			ANODO	ANODE	ANODO	ANODE	x 2		
F300C (2018+)	REC6CB-13016-00			TÓRICA	O-RING	O-RING	JOINT TORIQUE	1		
	REC6CB-14984-00			TÓRICA VST	VST O-RING	O-RING VST	JOINT TORIQUE VST	1		
	REC6P3-24564-00			TÓRICA	O-RING	O-RING	JOINT TORIQUE	1		
	REC6P3-WS24A-00			FILTRO COMBUSTIBLE	FUEL FILTER	FILTRO COMBUSTIBILE	FILTRE ESSENCE	1		
	PAF15-04000003			ARANDELA	WHASER	RONDELLA	RONDELLE	1		
	REC91490-40030			PIN BLOQUEADOR	COTTER PIN	COPPIGLIA	GOUPILLE	1		
	REC90430-08020			JUNTA DESAGÜE	DRAIN GASKET	GUARNIZIONE DRENAGGIO	JOINT DE VIDANGE	x 2		
	CMY200250KITA			KIT ÁNODOS	KIT ANODES	KIT ANODI	KIT ANODES	1		
	REC6CE-W0078-01			KIT BOMBA DE AGUA	WATER PUMP REPAIR KIT	KIT POMPA DELL'ACQUA	KIT POMPE À EAU	1		
	RECKITF300A			F300A (2008-11)	REC6AW-12411-00	TERMOSTATO	THERMOSTAT	TERMOSTATO	THERMOSTAT	x 2
					TEN01177	ANODO	ANODE	ANODO	ANODE	x 8
					REC6CB-13016-00	TÓRICA	O-RING	O-RING	JOINT TORIQUE	1
					NGKLF6A-11	BUJÍA	SPARK PLUG	CANDELE	BOUGIE	x 6
					TEN01170	ANODO	ANODE	ANODO	ANODE	x 2
			TEN01173	ANODO	ANODE	ANODO	ANODE	x 10		
			TEN01171	ANODO	ANODE	ANODO	ANODE	x 10		
			REC63P-13915-00	FILTRO COMBUSTIBLE	FUEL FILTER	FILTRO COMBUSTIBILE	FILTRE ESSENCE	1		
			REC6AW-14984-00	TÓRICA VST	O-RING VST	O-RING VST	TORIQUE VST	1		
			REC6P3-WS24A-00	FILTRO COMBUSTIBLE	FUEL FILTER	FILTRO COMBUSTIBILE	FILTRE ESSENCE	1		
			REC6P3-24564-00	TÓRICA	O-RING	O-RING	TORIQUE	1		
			PAF15-04000003	ARANDELA	WHASER	RONDELLA	RONDELLE	1		
			CMY300350XPKITA	KIT ÁNODOS	KIT ANODES	KIT ANODI	KIT ANODES	1		
			REC90430-08020	JUNTA DESAGÜE	DRAIN GASKET	GUARNIZIONE DRENAGGIO	JOINT DE VIDANGE	x 2		
			REC91490-40030	PIN BLOQUEADOR	COTTER PIN	COPPIGLIA	GOUPILLE	1		
			REC6AW-W0078-00	KIT BOMBA DE AGUA	WATER PUMP REPAIR KIT	KIT POMPA DELL'ACQUA	KIT POMPE À EAU	1		
			RECKITF350A	F350A (2008 +)	REC6AW-12411-00	TERMOSTATO	THERMOSTAT	TERMOSTATO	THERMOSTAT	x 2
					CM67F-11325-01A	ANODO	ANODE	ANODO	ANODE	x 10
	CM63P-11325-01A			ANODO	ANODE	ANODO	ANODE	x 3		
	NGKLF6A-11			BUJÍA	SPARK PLUG	CANDELE	BOUGIE	x 8		
	REC6CB-13016-00			TÓRICA	O-RING	O-RING	JOINT TORIQUE	1		
	TEN01172			ANODO	ANODE	ANODO	ANODE	x 2		
	TEN01177			ANODO	ANODE	ANODO	ANODE	x 8		
	REC6CB-24501-01			FILTRO COMBUSTIBLE	FUEL FILTER	FILTRO COMBUSTIBILE	FILTRE ESSENCE	1		
	REC6CB-13016-00			TÓRICA VST	O-RING VST	O-RING VST	TORIQUE VST	1		
	REC63P-13915-00			FILTRO COMBUSTIBLE	FUEL FILTER	FILTRO COMBUSTIBILE	FILTRE ESSENCE	1		
	REC6CB-14984-00			TÓRICA VST	O-RING VST	O-RING VST	TORIQUE VST	1		
	REC6P3-24564-00			TÓRICA	O-RING	O-RING	TORIQUE	1		
	REC6P3-WS24A-00			FILTRO COMBUSTIBLE	FUEL FILTER	FILTRO COMBUSTIBILE	FILTRE ESSENCE	1		
	CM15026A			ANODO	ANODE	ANODO	ANODE	1		
	CMY300350KITA			KIT ÁNODOS	KIT ANODES	KIT ANODI	KIT D'ANODES	1		
	TEN01170			ANODO	ANODE	ANODO	ANODE	1		
	TEN01175			ANODO	ANODE	ANODO	ANODE	1		
	TEN01174			ANODO	ANODE	ANODO	ANODE	1		
	CM63P-11325-11A	ANODO	ANODE	ANODO	ANODE	1				
	PAF15-04000003	ARANDELA	WHASER	RONDELLA	RONDELLE	1				
	REC90430-08020	JUNTA DESAGÜE	DRAIN GASKET	GUARNIZIONE DRENAGGIO	JOINT DE VIDANGE	x 2				
	REC6AW-W0078-00	KIT BOMBA DE AGUA	WATER PUMP REPAIR KIT	KIT POMPA DELL'ACQUA	KIT POMPE À EAU	1				
	REC91490-40030	PIN BLOQUEADOR	COTTER PIN	COPPIGLIA	GOUPILLE	1				

# SISTEMA DE ALIMENTACIÓN Y FILTRACIÓN FUEL & FILTRATION SYSTEM

## SISTEMA DI ALIMENTAZIONE E FILTRAZIONE SYSTÈME D'ALIMENTATION ET DE FILTRATION

BOMBA DE  
COMBUSTIBLE

FUEL PUMP

POMPA BENZINA

POIRE À  
CARBURANT

BOMBA DE COMBUSTIBLE

FUEL PUMP

POMPA BENZINA

POIRE À CARBURANT

Fabricada con elastómeros termoplásticos inyectados, resistentes al alcohol y rayos UV.s

Premium quality bulb resistance to alcohol as well as UV and ozone.

Fabbricata con elastomero termoplastico, resistente ai solventi e raggi UV.

Fabriqué avec des élastomères thermo-plastiques injectés, résistant à l'alcool et aux rayons UV.

REF		
GS31187	1/4" = 6 mm	1
GS31090	5/16" = 8 mm	1
GS31095	3/8" = 9.5 mm	1



**GOLDENSHIP**

LÍNEA DE COMBUSTIBLE

FUEL LINE ASSEMBLY

TUBO CARBURANTE

TUYAU CARBURANT

Universal. Manguera resistente al alcohol.

Universal. Alcohol resistant hose.

Universale. Tubo resistente ai solventi.

Universelle. Tuyau résistant à l'alcool.

REF		
GS31096	5/16" x 2 m	1
GS31097	3/8" x 2 m	1
GS31099	8 mm x 2 m	1
SIE18-8013	5/16" x 2 m	1
SIE18-8015	3/8" x 2 m	1



SIE18-8013  
SIE18-8015

**new**

REF	OEM		
GS31183	6Y1-24360-52-00	6 mm x 2 m	1
	6Y1-24360-52-01		
	6Y1-24360-52-02		
	6Y1-24360-52-51		
	6Y1-24360-52-52		

**GOLDENSHIP**

**new**

REF	OEM		
PAF15-09000000	6G1-24306-55	6 mm x 3m	1
	6Y1-24306-55-00		

MANGUERA DE  
COMBUSTIBLE

FUEL HOSE

TUBO BENZINA

TUYAU CARBURANT

Manguera «Trident» para líneas de combustible. Con refuerzo termoplástico que le permite excelente flexibilidad y resistencia a los rayos UV. Color gris. Resistente al alcohol. Especialmente indicado para motores fueraborda. Garantía: 3 años

Marine fuel hose (distribution and vent) for outboards. Fuel resistant thermo-plastic formulation with 2 spiral reinforcement provides excellent bendability and resistance to UV, aging and permeation by all marine fuels (gasoline/petrol and diesel) including alcohol blends. Warranty: 3 years

Tubo «Trident» per linea combustibile. Con rinforzo termoplastico che gli permette un'eccellente flessibilità e resistenza ai raggi UV. Colore grigio. Resistente ai solventi. Indicato per i motori fuoribordo. Garanzia: 3 anni

Tuyau «Trident» pour carburant. Avec renfort thermoplastique qui permet une excellente flexibilité et résistance aux rayons UV. Gris. Résistant à l'alcool. Convient particulièrement aux moteurs hors-bord. Garantie: 3 ans

REF				
TRI305-0566	5/16" = 7,92 mm	15 m	1	SAEJ1527
TRI305-0386	3/8" = 9,53 mm	15 m	1	ISO-8469 B1 CE



**TRIDENT**

MADE IN THE USA  
CE CERTIFIED

YAMAHA

De goma para diesel y gasolina sin plomo. Ideal para fueraborda. Refuerzos textiles internos. Muy flexible.  
Contenido aromático 50%

Rubber Hose suitable for loading mineral oils, diesel and unloaded fuel

In gomma per diesel e benzina senza piombo. Ideale per motori fuoribordo. Tessuto interno rinforzato. Molto flessibile.

Caoutchouc pour diesel et essence sans plomb. Idéal pour le hors-bord. Renforts textiles internes. Très flexible



### CARBUPOMP/10NL

REF	Ø (mm)					
GS35031	6x12	10 bar	50 mm	-25°C → 80°C	50 m	ISO R1307
GS35032	8x15	10 bar	65 mm		50 m	

H.T. - CARBUPOMP/10NL - WP 10 BAR - R<1M Ø/m - ISO R1307

### MUELLE TUBO COMBUSTIBLE

### SPRING, FUEL PIPE

### MOLLA TUBO COMBUSTIBILE

### RESSORT, TUYAU DE CARBURANT

new

REF	OEM
PAF4-04000030	90467-08004
PAF4-05000010	90467-13M13



### ABRAZADERA

### CLAMP SMALL

### FASCETTE

### COLLIER

new

REF	OEM	
REC650-24351-51	650-24351-00	6 mm
	650-24351-01	
	650-24351-50	
	650-24351-51	
REC6E5-24351-51	6E5-24351-00	8 mm
	6E5-24351-51	



REF		
REC09401-11425	6-8 mm	1
REC09401-11425BULK	6-8 mm	25



### ADPATADOR LÍNEA DE COMBUSTIBLE

### COUPLER

### ADATTATORE

### RACCORD COUPLEUR

REF	Ø 11 mm --> Ø 9 mm
REC22-8M0001721	



### COMPONENTES TANQUE Y CONECTORES

### FUEL TANK COMPONENTS & CONNECTORS

### COMPONENTI SERBATOIO E CONETTORI

### COMPOSANTS ET CONNECTEURS DU RÉSERVOIR

### TAPÓN CON RESPIRADERO

### PLUG WITH BREATHER

### SPINA CON RESPIRO

### BOUCHON AVEC EVENT

new

REF	OEM
PAF15-10010000	6YJ-24610-01
	6YJ-24610-00



### TAPÓN

### PLUG

### TAPPO

### BOUCHON

new

REF	OEM	
PAF4-04120100	67D-24610-00	F2.5 F4
	67D-24610-02	
	67D-24610-03	
	67D-24610-04	
	68D-24610-10	



### RESORTE DE SEGURIDAD PARA TAPÓN

### SPRING, PREVENT DESQUAMATING

### MOLLA SICURTÀ PER TAPPO

### RESSORT DE SÉCURITÉ POUR LE BOUCHON

new

REF	OEM
PAF4-04120103	624-24634-00



**FILTRO** **FILTER** **FILTRO** **FILTRE** new

REF	OEM
PAF15-1000002	6YJ-24167-00



**MEDIDOR DE COMBUSTIBLE** **OLEOMETER ASSY** **MISURATORE DI CARBURANTE** **TUBE D'ASPIRAZIONE POUR RESERVOIR** new

REF	OEM
PAF15-10020000	6YJ-24260-00
PAF15-10000003	6YJ-24260-10 6Y1-24268-00

PAF15-10020000



PAF15-10000003



**LLAVE DE CIERRE DE DEPOSITO** **KNOB OIL SWITCH** **CHIAVE DE DEPOSITO BLOCCO** **COMMUTATEUR D'HUILE AVEC BOUTON** new

REF	OEM	Image
PAF2.6-00000004	69M-24575-00	F2.5



**CONECTOR DE DEPÓSITO** **TANK CONNECTOR** **ATTACCO SERBATOIO** **RACCORDS DE RESERVOIR**

Fabricado en latón. Made in machined brass. Fabbricato in ottone. Fait en laiton.

REF	Image	Quantity
GS31068		1



**GOLDENSHIP**

Para conectar dos motores a un sólo depósito, o viceversa. To connect two motors to a single tank, or vice versa. Per collegare due motori a un singolo serbatoio o viceversa. Pour connecter deux moteurs à un même réservoir, ou inversement.  
 Fabricado en latón. Made in machined brass Fabbricato in ottone. Fait en laiton.

REF	Image	Quantity
GS31069		1



**GOLDENSHIP**  
MADE IN THE USA

REF	OEM	Image	Quantity
GS31074	6Y1-24305-05-00		1
	6Y1-24305-06, -00		
	6YL-24305-01-00		
	6G1-24305-00, 01, 02		
	6G1-24305-02-00		
GS31075	6G1-24305-03, -00		1
	6G1-24305-04, -00		
	6G1-24305-05, -00		
	6G1-24305-0500		
	6Y1-24305-00, -01, -02		
	6Y1-24305-05-00		
GS31076	6Y1-24305-06-00		1
	6YL-24305-01-00		
	6E5-24305-05-00		
	6E5-24305-06, -00		
GS31076	6Y2-24305-05-00		1
	6Y2-24305-06-00		
	6YK-24305-01-00		



**GOLDENSHIP**  
MADE IN THE USA

new

REF	OEM	
REC6G1-24304-02	6G1-24304-02	6 mm



Conector doble

Double connector

Connettore doppio

Double connecteur

REF		
GS31092	8 mm	1



Toma de tanque de combustible.  
Fabricado en latón.

Fuel tank connector  
Made in machined brass

Filettatura per serbaotio benzina  
Fabbricato in ottone.

Prise de réservoir de carburant.  
Fait en laiton.

REF		
GS31073	1/4" NPT	1
GS31020	1/4" NPT	1

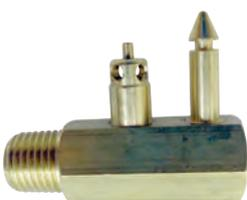

GS31073



GS31020



PASAMAMPAROS

THRU HULL

PASSASCAFO

PASSE-CLOISON

Para atravesar mamparos de hasta 12 mm. Fabricado en latón.

For bulkhead up to 12 mm. Made in machined brass.

Per attraversare paratie fino a 12 mm. Fabbricato in ottone.

Pour traverser des cloisons jusqu'à 12 mm. Fait en laiton.

REF		
GS31064	3/8"	1



FILTRO DE COMBUSTIBLE Y ELEMENTOS

FUEL FILTERS AND ELEMENTS

FILTRI BENZINA E RACCORDI

FILTRE A ESSENCE ET CARTOUCHE DE RECHANGE

BRACKET

BRACKET

SUPPORTO

TÊTE DE FILTRE À ESSENCE

Con 2 tapones de bronce y 2 tubos de extensión. (2 entradas y 2 salidas).

With 2 brass plugs and 2 extension tubes. (2 inputs & 2 outputs).

Con 2 tappi di bronzo e 2 tubi di estensione. (2 ingressi entrata carburante e 2 uscite carburante).

Avec 2 bouchons en bronze et 2 tubes d'extension. (2 entrées et 2 sorties).

REF		
REC25000	1/4"	AL
REC25010	1/4"	INOX /SS AISI316
REC25020	3/8"	AL
REC25030	3/8"	INOX /SS AISI316
RECOBBRACKET	1/4"	Plástico   Plastic Plastica   Plastique



REC25000 - REC25020



REC25010 - REC25030



RECOBBRACKET

FILTRO COMBUSTIBLE SEPARADOR DE AGUA

WATER SEPARATING FUEL FILTER

FILTRO SEPARATORE ACQUA-BENZINA

FILTRE À ESSENCE

REF	MICRON	
REC24942	10	4 <sup>7</sup> / <sub>16</sub> " = 11 cm
REC35-802893Q01	10	3 <sup>3</sup> / <sub>4</sub> "
REC855686	28	4 <sup>7</sup> / <sub>16</sub> "
REC35-802893Q	25	3 <sup>3</sup> / <sub>4</sub> "
RACPF5510	10	4 <sup>7</sup> / <sub>16</sub> "

RACOR

RECMAR



RACPF5510



REC24942



REC35-802893Q01



REC855686



REC35-802893Q

YAMAHA

Filtro original.

OEM filter.

Filtro benzina originale.

Filtre à essence original

REF	MICRON	
RM35-802893Q	10	3 3/4"



**FILTRO CON BRACKET**

Con 2 tapones de bronce y 1 tubo de extensión.

**OEM FILTER WITH BRACKET**

With 2 brass plugs & 1 extension tube.

**FILTRO BENZINA CON SUPPORTO**

Con 2 tappi di bronzo e 1 tubo di estensione.

FILTRE A ESSENCE AVEC SUPPORT avec 2 bouchons en bronze et 1 tube d'extension

REF	MICRON			BRACKET 
REC24950	25	1/4"	50 GPH	AL
REC24952	10	1/4"	50 GPH	AL



**FILTRO DECANTADOR DE COMBUSTIBLE COMPLETO CON VASO TRASPARENTE**

**COMPLET FUEL FILTER WITH TRANSPARENT BOWL**

**FILTRO DI DECANTAZIONE BENZINA COMPLETO CON VASCHETTA TRASPARENTE**

**FILTRE SÉPARATEUR D'ESSENCE**

REF	OEM		BRACKET 
RAC320R-RAC-01	YMM-2W227-01		AL
RAC320R-RAC-03		RACS3213	Plástico Plastic Plastique

REF			BRACKET 
RECOFILALU			AL
RECOFILTER	RECOBELEMENT	150 l/h	Plástico Plastic Plastique



REF	OEM		R.O. / OEM	MICRON		
REC90794-46866	907-94469-05	REC90794-46868	907-94469-13	10	117 l/h	175 hp



Ø 8mm



**LLAVE PARA FILTRO  
FILTER KEY  
CHIAVE DA FILTRO  
CLÉ A FILTRE**

REF
RECYS-225-15





REF	R.O./OEM	MICRON	
PAF40-0701000EI	907-94469-05	10	70 hp



Ø 6 mm



new



REF	OEM		OEM	MICRON		
RAC120R-RAC-01	YMM-2W114-00	RACS3240	YMM-2E114-00	10	114 l/h	50 -115 hp

**RACOR**



new

FILTRO CON BOMBA CEBADORA

FILTER WITH PRIMMING PUMP

FILTRO CON PEMPETA PER RIEMPIRE

FILTRE ESSENCE AVEC POMPE D'AMORCAGE

REF	OEM		OEM	MICRON			
RAC490R-RAC-01	YMM-2W227-01	RACS3227	YMM-2E227-00, 01	10	340 l/h	3/8" NPTF	150 hp

**RACOR**



LLAVES PARA FILTRO

FILTER KEY

CHIAVE DA FILTRO

CLÉ À FILTRE

REF
RACRK22628

**RACOR**



REF	
REC70720	65 - 110 mm



RACOR DE LATÓN

RACOR MADE IN BRASS

RACCORDO IN OTTONE

RACCORD EN LAITON

REF			
GS31065	1/4" NPT	3/8" = 9.5 mm	1
GS31166	1/4" NPT	5/16" = 7.9 mm	2
GS31155	3/8" NPT	3/8" = 9.5 mm	2
GS31156	3/8" NPT	5/16" = 7.9 mm	2
GS31157	3/8" NPT	1/4" = 6.4 mm	2



REF			
GS31066	1/4" NPT	5/16" = 7.9 mm	2
GS31067	1/4" NPT	3/8" = 9.5 mm	2



**GOLDENSHIP**

YAMAHA

**FILTRO COMBUSTIBLE PARA MONTAJE EN LINEA**

**IN-LINE FUEL FILTER**

**FILTRO BENZINA PER MONTARE IN LINEA**

**FILTRE A ESSENCE EN LIGNE**

REF				
GS31001	50 l/h	6-8 mm	plástico plastic plastica plastique	1
GS31002	150 l/h	8-10 mm	plástico plastic plastica plastique	1



REF			
GS30435	6, 8, 10 mm	metal + cristal metal + crystal metallo + cristallo métal + cristal	1



REF	OEM			
REC40145	65W-24251-10	1/4"	1/4"	plástico plastic plastica plastique
REC40155		5/16"	5/16"	
REC40165	67F-24251-02	3/8"	3/8"	
REC40135		5/16"	3/8"	



REF	OEM	
PAF4-04120005	6L5-24251-00	



REF	OEM		
REC35-80365M	646-24251-02		
PAF4-05000300	646-24251-01		



REF	OEM		
REC68T-24251-00	68T-24251-00 68T-24251-01 6EE-F4251-00	F6, F8 (2001+)	



REF	OEM	
REC6F5-24563-00	6F5-24563-00	9.9 hp
REC61N-24563-10	61N-24563-10 61n-24563-00	



REC6F5-24563-00

REC61N-24563-10

REF	OEM	
PAF15-07080000	61N-24560-00	15 - 60 hp



REF	OEM	
PAF15-07080002	61N-24521-00	plástico plastic plastica plastique



REF	OEM
REC64J-24560-10	64J-24560-00 64J-24560-10

- E75, 75AE, AET (2003-15)
- 85 AED, AET (2003-15)
- F40 (2002-07)
- T50, FT50, F50 (2001-16)
- T60, FT60, F60 (2002-07)



REF	OEM
REC6BG-13915-00	6BG-13915-00

- F30 (2013)
- F40 (2008-13)
- F50 (2005-13)
- F60 (2005-13)
- F70 (2010-13)
- F75 (2005-13)
- F90 (2005-13)
- T50 (2005-13)
- T60 (2005-13)



REF	OEM
REC6C5-24251-00	6C5-24251-00

- F30 (2009+)
- F40 (2006+)
- F50 (2005+)
- F60 (2005+)
- F70 (2011+)
- F75 (2005)
- F80 (2008+)
- F100 (2005+)
- F115 (2014+)
- F130 (2015+)



REF	OEM
REC68V-24563-00	68V-24563-00

- EUROPE
- F40
- F50
- F50
- F80
- F100
- F115



REF	OEM
REC6D8-WS24A-00	6D8-WS24A-00 6D8-24563-00

- F50 - F115



REF	OEM
REC68F-24563-10	68F-24563-10



150-300HP (2004-06)  
Z, VZ, LZ

REF	OEM
REC6P2-WS245-00	6P2-WS245-00 6P2-24563-00



F (L) 200C  
F (L) 250A

REF	OEM
REC6C5-13915-00	6C5-13915-00

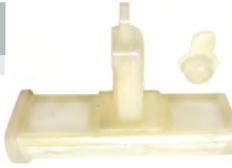

F50 (2005-13) F90 (2005-13)  
F60 (2005-13) T50 (2005-13)  
F70 (2010-13) T60 (2005-13)  
F75 (2005-13)

REF	OEM
REC68F-24563-00	68F-24563-00



(L) Z 150P, Q  
(L) Z 175 G  
(L) Z 200N/P  
(L) Z 250 D/F

REF	OEM
REC69J-24501-10	69J-24501-10



F150-F225 (2006-14)  
F250 (2005-14)

REF	OEM
REC69J-24502-00	69J-24502-00



LF/FL/F150A,T,D,B (2005+)  
LF/FL/F200A,T,B (2004-11)  
LF/FL/F225T,A (2004-11)  
F75T, B (2005)  
F80B,A (2005+)  
F90,T,B,A (2013+)  
F100D (2005+)

REF	OEM
REC6P3-WS24A-00	6P3-WS24A-00 6P3-WS24A-01 6P3-24563-00



F150 (2007-11) F350 (2008-11)  
Z200 (2007) F250 (2009-11)  
Z150/175 (2007) Z300 (2007)  
F225 (2007-11) F300 (2011)  
F200 (2007-11)

REF	OEM
REC6P3-24564-00	6P3-24564-00



REF	OEM
REC65L-24563-00	65L-24563-00



F200 (2002-06)  
F150 (2004-06)  
225FETO (2003)  
L/250B (1997-2003)

REF	OEM
REC61A-24563-00	61A-24563-00



V6, 3'1L, D-T

**GUÍA FILTROS DE COMBUSTIBLE FUEL FILTER GUIDE GUIDA FILTRO BENZINA GUIDE FILTRE À ESSENCE**

	REF
3A / F2,5A / F4A	PAF4-04120005
4A / 5C / 6C / 8C	PAF4-05000300
F4B / F5A / F6A / F6C / F8C / FT8D / F9,9J / FT9,9L	REC68T-24251-00
F9,9C / FT9,9D / F15A / F25A / FT25B (-2004)	REC40145
F9,9C (1001584+) / FT9,9D (1001139+) / F15A (1009198+) / F25A & FT25B (1013331+) (2004+)	REC61N-24563-10
F25G	REC6D8-WS24A-00
F30A / F40B	REC40145
FT50B (-2000)	REC61N-24563-10
FT50B (2001+)	REC68V-24563-00
F60A / FT60B (-2003)	REC68V-24563-00
F60A / FT60B (2004+)	REC61N-24563-10
F50F / FT50G / F60C / FT60D (-2006)	REC68V-24563-00
F50F / FT50G / F60C / FT60D (2007+)	REC6D8-WS24A-00
F30B / F40F / F50H / F60F / FT50J / FT60G / F70A	REC6D8-WS24A-00
F80A / F100A (-2001)	REC40165
F80A / F100A (2002+)	REC61N-24563-10
F80B / F100D / F(L)115A (-2006)	REC68V-24563-00
F80B / F100D / F(L)115A (2007+) / F(L)115B	REC6D8-WS24A-00
F100F	REC6D8-WS24A-00

	REF
F(L)150A / F(L)200A / F200B / F(L)225A(-2006)	REC65L-24563-00
F(L)150A / F(L)200A / F200B / F(L)225A (2007+)	REC6P3-WS24A-00
F(L)200C / F(L)250A (-2006)	REC6P2-WS245-00
F(L)200C / F(L)250A (2007+)	REC6P3-WS24A-00
F(L)225B / F225C / F(L)225F (V6 4,2L) / F(L)250D (V6 4,2L) / F(L)300A / F(L)300B(V6 4,2L) / F(L)350A / F(L)200F / F(L)200G / F175A	REC6P3-WS24A-00
9,9F / 15F / F15C / F20B / 25N / F25D / FT25F / 30D / 40V / 50G / F50A / 60F / 75C / 90A / 100A / F100B / 115C / (L)130B / (L)150F / 175D / (L)200F / 200G / 225D	REC61N-24563-10
115B	REC6F5-24563-00
(L)250A	REC61A-24563-00
225G / 250B	REC65L-24563-00
(L)Z150P / (L)Z150Q / Z175G / (L)Z200N / Z200P (-2004)	REC68F-24563-00
(L)Z150P / (L)Z150Q / Z175G / (L)Z200N / Z200P (2005-06)	REC68F-24563-10
(L)Z150P / (L)Z150Q / Z175G / (L)Z200N / Z200P (2007+)	REC6P3-WS24A-00
(L)Z250D / Z250F (-2003)	REC68F-24563-00
(L)Z250D / Z250F (2004-06)	REC68F-24563-10
(L)Z250D / Z250F (2007+)	REC6P3-WS24A-00
(L)Z300A (-2006)	REC68F-24563-10
(L)Z300A (2007+)	REC6P3-WS24A-00

FILTRO VST		VST FILTER	FILTRO VST	FILTRE VST																																															
<table border="1"> <thead> <tr> <th>REF</th> <th>OEM</th> </tr> </thead> <tbody> <tr> <td>REC68V-13915-00</td> <td>68V-13915-00</td> </tr> </tbody> </table>		REF	OEM	REC68V-13915-00	68V-13915-00		<table border="1"> <thead> <tr> <th>REF</th> <th>OEM</th> </tr> </thead> <tbody> <tr> <td>REC68F-13915-00</td> <td>68F-13915-00</td> </tr> </tbody> </table>		REF	OEM	REC68F-13915-00	68F-13915-00																																							
REF	OEM																																																		
REC68V-13915-00	68V-13915-00																																																		
REF	OEM																																																		
REC68F-13915-00	68F-13915-00																																																		
<table border="1"> <tbody> <tr> <td></td> <td>F115 (2000-09)</td> <td></td> <td>HPDI 150 (2000-05)</td> <td></td> </tr> <tr> <td></td> <td>F200 TXR (2002-09)</td> <td></td> <td>V-Max HPDI 150 (2000-09)</td> <td></td> </tr> <tr> <td></td> <td>LF200 TXR (2002-09)</td> <td></td> <td>HPDI 225 (2003-09)</td> <td></td> </tr> <tr> <td></td> <td>F225 TXR (2002-09)</td> <td></td> <td>HPDI 250 (2003-09)</td> <td></td> </tr> <tr> <td></td> <td>F225 TUR (2002-09)</td> <td></td> <td>HPDI 300 (2004-09)</td> <td></td> </tr> </tbody> </table>			F115 (2000-09)		HPDI 150 (2000-05)			F200 TXR (2002-09)		V-Max HPDI 150 (2000-09)			LF200 TXR (2002-09)		HPDI 225 (2003-09)			F225 TXR (2002-09)		HPDI 250 (2003-09)			F225 TUR (2002-09)		HPDI 300 (2004-09)																										
	F115 (2000-09)		HPDI 150 (2000-05)																																																
	F200 TXR (2002-09)		V-Max HPDI 150 (2000-09)																																																
	LF200 TXR (2002-09)		HPDI 225 (2003-09)																																																
	F225 TXR (2002-09)		HPDI 250 (2003-09)																																																
	F225 TUR (2002-09)		HPDI 300 (2004-09)																																																
<table border="1"> <thead> <tr> <th>REF</th> <th>OEM</th> </tr> </thead> <tbody> <tr> <td>REC66K-13915-00</td> <td>66K-13915-00</td> </tr> </tbody> </table>		REF	OEM	REC66K-13915-00	66K-13915-00		<table border="1"> <thead> <tr> <th>REF</th> <th>OEM</th> </tr> </thead> <tbody> <tr> <td>REC65L-13915-00</td> <td>665L-13915-00</td> </tr> </tbody> </table>		REF	OEM	REC65L-13915-00	665L-13915-00																																							
REF	OEM																																																		
REC66K-13915-00	66K-13915-00																																																		
REF	OEM																																																		
REC65L-13915-00	665L-13915-00																																																		
<table border="1"> <tbody> <tr> <td></td> <td>HDX150 (1999-05)</td> <td>LX225 (2000-03)</td> <td>L225 (1997-98)</td> <td></td> </tr> <tr> <td></td> <td>LX150 (1999-01)</td> <td>S225 (1999)</td> <td>S225 (1997-98)</td> <td></td> </tr> <tr> <td></td> <td>PX150 (1999)</td> <td>SX225 (2000-03)</td> <td>L250 (1997-98)</td> <td></td> </tr> <tr> <td></td> <td>SX150 (1999-04)</td> <td>V225 (1999)</td> <td>V200 (1998)</td> <td></td> </tr> <tr> <td></td> <td>VX150 (2000-04)</td> <td>VX225 (2000-04)</td> <td>V225 (1998)</td> <td></td> </tr> <tr> <td></td> <td>LX200 (1999-01)</td> <td>L250 (1999)</td> <td></td> <td></td> </tr> <tr> <td></td> <td>SX200 (1999-05)</td> <td>LX250 (2000-03)</td> <td></td> <td></td> </tr> <tr> <td></td> <td>V200 (1999)</td> <td>SX250 (2000-03)</td> <td></td> <td></td> </tr> <tr> <td></td> <td>VX200 (2000-05)</td> <td>VX250 (2002-04)</td> <td></td> <td></td> </tr> <tr> <td></td> <td>L225 (1999)</td> <td></td> <td></td> <td></td> </tr> </tbody> </table>			HDX150 (1999-05)	LX225 (2000-03)	L225 (1997-98)			LX150 (1999-01)	S225 (1999)	S225 (1997-98)			PX150 (1999)	SX225 (2000-03)	L250 (1997-98)			SX150 (1999-04)	V225 (1999)	V200 (1998)			VX150 (2000-04)	VX225 (2000-04)	V225 (1998)			LX200 (1999-01)	L250 (1999)				SX200 (1999-05)	LX250 (2000-03)				V200 (1999)	SX250 (2000-03)				VX200 (2000-05)	VX250 (2002-04)				L225 (1999)			
	HDX150 (1999-05)	LX225 (2000-03)	L225 (1997-98)																																																
	LX150 (1999-01)	S225 (1999)	S225 (1997-98)																																																
	PX150 (1999)	SX225 (2000-03)	L250 (1997-98)																																																
	SX150 (1999-04)	V225 (1999)	V200 (1998)																																																
	VX150 (2000-04)	VX225 (2000-04)	V225 (1998)																																																
	LX200 (1999-01)	L250 (1999)																																																	
	SX200 (1999-05)	LX250 (2000-03)																																																	
	V200 (1999)	SX250 (2000-03)																																																	
	VX200 (2000-05)	VX250 (2002-04)																																																	
	L225 (1999)																																																		
<table border="1"> <thead> <tr> <th>REF</th> <th>OEM</th> </tr> </thead> <tbody> <tr> <td>REC63P-13915-00</td> <td>63P-13915-00</td> </tr> </tbody> </table>		REF	OEM	REC63P-13915-00	63P-13915-00		<table border="1"> <thead> <tr> <th>REF</th> <th>OEM</th> </tr> </thead> <tbody> <tr> <td>REC60V-24251-01</td> <td>60V-24251-01</td> </tr> </tbody> </table>		REF	OEM	REC60V-24251-01	60V-24251-01																																							
REF	OEM																																																		
REC63P-13915-00	63P-13915-00																																																		
REF	OEM																																																		
REC60V-24251-01	60V-24251-01																																																		
<table border="1"> <tbody> <tr> <td></td> <td>F150 TXR (2004-09)</td> <td>F300 TXR (2007-09)</td> <td>LZ150 (2005)</td> <td>VZ225 (2005-09)</td> </tr> <tr> <td></td> <td>F150 TLR (2004-09)</td> <td>F300 TUR (2007-09)</td> <td>VZ150 (2005-10)</td> <td>LZ250 (2005)</td> </tr> <tr> <td></td> <td>F150 TJR (2009)</td> <td>F350 TXR (2007-09)</td> <td>Z150 (2005)</td> <td>VZ250 (2005-09)</td> </tr> <tr> <td></td> <td>LF150 TXR (2004-09)</td> <td>F350 TUR (2007-09)</td> <td>VZ175 (2005-10)</td> <td>Z250 (2005)</td> </tr> <tr> <td></td> <td>F250 TXR (2005-09)</td> <td>F225 TLR (2007-09)</td> <td>Z175 (2005)</td> <td>LZ300 (2005-06)</td> </tr> <tr> <td></td> <td>F250 TUR (2005-09)</td> <td></td> <td>LZ200 (2005-10)</td> <td>VZ300 (2005-09)</td> </tr> <tr> <td></td> <td></td> <td></td> <td>VZ200 (2005-09)</td> <td>Z300 (2005-06)</td> </tr> <tr> <td></td> <td></td> <td></td> <td>Z200 (2005-10)</td> <td></td> </tr> </tbody> </table>			F150 TXR (2004-09)	F300 TXR (2007-09)	LZ150 (2005)	VZ225 (2005-09)		F150 TLR (2004-09)	F300 TUR (2007-09)	VZ150 (2005-10)	LZ250 (2005)		F150 TJR (2009)	F350 TXR (2007-09)	Z150 (2005)	VZ250 (2005-09)		LF150 TXR (2004-09)	F350 TUR (2007-09)	VZ175 (2005-10)	Z250 (2005)		F250 TXR (2005-09)	F225 TLR (2007-09)	Z175 (2005)	LZ300 (2005-06)		F250 TUR (2005-09)		LZ200 (2005-10)	VZ300 (2005-09)				VZ200 (2005-09)	Z300 (2005-06)				Z200 (2005-10)											
	F150 TXR (2004-09)	F300 TXR (2007-09)	LZ150 (2005)	VZ225 (2005-09)																																															
	F150 TLR (2004-09)	F300 TUR (2007-09)	VZ150 (2005-10)	LZ250 (2005)																																															
	F150 TJR (2009)	F350 TXR (2007-09)	Z150 (2005)	VZ250 (2005-09)																																															
	LF150 TXR (2004-09)	F350 TUR (2007-09)	VZ175 (2005-10)	Z250 (2005)																																															
	F250 TXR (2005-09)	F225 TLR (2007-09)	Z175 (2005)	LZ300 (2005-06)																																															
	F250 TUR (2005-09)		LZ200 (2005-10)	VZ300 (2005-09)																																															
			VZ200 (2005-09)	Z300 (2005-06)																																															
			Z200 (2005-10)																																																

GUÍA FILTROS VST		FUEL FILTER GUIDE	GUIDA FILTRO BENZINA	GUIDE FILTRES VST																																																																														
<table border="1"> <thead> <tr> <th>REF</th> <th>OEM</th> </tr> </thead> <tbody> <tr> <td>PAF4-04120005</td> <td>6L5-24251-00</td> </tr> </tbody> </table>		REF	OEM	PAF4-04120005	6L5-24251-00	<table border="1"> <tbody> <tr> <td>9.9C/D/F</td> <td></td> </tr> <tr> <td>15C/D/F</td> <td></td> </tr> <tr> <td>20/D/F</td> <td></td> </tr> <tr> <td>25B/D/J/N/Q/V</td> <td></td> </tr> <tr> <td>30D/GH</td> <td></td> </tr> <tr> <td>40H/QM/X/Y/F,</td> <td></td> </tr> <tr> <td>40A/B/F</td> <td></td> </tr> <tr> <td>45A/F,</td> <td></td> </tr> <tr> <td>50A/B/FT, 50A,</td> <td></td> </tr> <tr> <td>50D/G/H/PRO,</td> <td></td> </tr> <tr> <td>50</td> <td></td> </tr> <tr> <td>55B</td> <td></td> </tr> <tr> <td>60F</td> <td></td> </tr> <tr> <td>70B</td> <td></td> </tr> <tr> <td>75A/C/PRO</td> <td></td> </tr> <tr> <td>80A</td> <td></td> </tr> <tr> <td>85A</td> <td></td> </tr> <tr> <td>90A</td> <td></td> </tr> <tr> <td>100A/PROV,</td> <td></td> </tr> <tr> <td>100/115B/C(L)</td> <td></td> </tr> <tr> <td>130B/D</td> <td></td> </tr> <tr> <td>150H/ (L), 150C/</td> <td></td> </tr> <tr> <td>(L), 150F</td> <td></td> </tr> <tr> <td>175B/D/(L)</td> <td></td> </tr> <tr> <td>200B/(L),</td> <td></td> </tr> <tr> <td>200F/G/PROV,</td> <td></td> </tr> <tr> <td>200/225B/D</td> <td></td> </tr> <tr> <td>(1994)</td> <td></td> </tr> <tr> <td>FT</td> <td></td> </tr> <tr> <td>9.9D, F9.9C/F</td> <td></td> </tr> <tr> <td>15A/F</td> <td></td> </tr> <tr> <td>20A/F</td> <td></td> </tr> <tr> <td>25A/FT, 25B/F</td> <td></td> </tr> <tr> <td>30A/F</td> <td></td> </tr> <tr> <td>40B</td> <td></td> </tr> </tbody> </table>	9.9C/D/F		15C/D/F		20/D/F		25B/D/J/N/Q/V		30D/GH		40H/QM/X/Y/F,		40A/B/F		45A/F,		50A/B/FT, 50A,		50D/G/H/PRO,		50		55B		60F		70B		75A/C/PRO		80A		85A		90A		100A/PROV,		100/115B/C(L)		130B/D		150H/ (L), 150C/		(L), 150F		175B/D/(L)		200B/(L),		200F/G/PROV,		200/225B/D		(1994)		FT		9.9D, F9.9C/F		15A/F		20A/F		25A/FT, 25B/F		30A/F		40B		<table border="1"> <thead> <tr> <th>REF</th> <th>OEM</th> </tr> </thead> <tbody> <tr> <td>REC61N-24563-10</td> <td>61N-24563-10</td> </tr> </tbody> </table>		REF	OEM	REC61N-24563-10	61N-24563-10
REF	OEM																																																																																	
PAF4-04120005	6L5-24251-00																																																																																	
9.9C/D/F																																																																																		
15C/D/F																																																																																		
20/D/F																																																																																		
25B/D/J/N/Q/V																																																																																		
30D/GH																																																																																		
40H/QM/X/Y/F,																																																																																		
40A/B/F																																																																																		
45A/F,																																																																																		
50A/B/FT, 50A,																																																																																		
50D/G/H/PRO,																																																																																		
50																																																																																		
55B																																																																																		
60F																																																																																		
70B																																																																																		
75A/C/PRO																																																																																		
80A																																																																																		
85A																																																																																		
90A																																																																																		
100A/PROV,																																																																																		
100/115B/C(L)																																																																																		
130B/D																																																																																		
150H/ (L), 150C/																																																																																		
(L), 150F																																																																																		
175B/D/(L)																																																																																		
200B/(L),																																																																																		
200F/G/PROV,																																																																																		
200/225B/D																																																																																		
(1994)																																																																																		
FT																																																																																		
9.9D, F9.9C/F																																																																																		
15A/F																																																																																		
20A/F																																																																																		
25A/FT, 25B/F																																																																																		
30A/F																																																																																		
40B																																																																																		
REF	OEM																																																																																	
REC61N-24563-10	61N-24563-10																																																																																	
<table border="1"> <tbody> <tr> <td>3A, F4A</td> <td></td> </tr> <tr> <td>4A, F4A</td> <td></td> </tr> <tr> <td>5C</td> <td></td> </tr> <tr> <td>6C/D</td> <td></td> </tr> <tr> <td>8C, F8B</td> <td></td> </tr> <tr> <td>F9.9A/B, FT9.9A</td> <td></td> </tr> <tr> <td>HPDI</td> <td></td> </tr> <tr> <td>FT8D</td> <td></td> </tr> <tr> <td>9.9D</td> <td></td> </tr> <tr> <td>15D</td> <td></td> </tr> <tr> <td>20C/D</td> <td></td> </tr> <tr> <td>25D/J/N/Q</td> <td></td> </tr> <tr> <td>30A/D/G</td> <td></td> </tr> <tr> <td>40H/Q</td> <td></td> </tr> <tr> <td>50D/G</td> <td></td> </tr> <tr> <td>55B</td> <td></td> </tr> <tr> <td>60F</td> <td></td> </tr> <tr> <td>70B</td> <td></td> </tr> <tr> <td>75A</td> <td></td> </tr> <tr> <td>80A</td> <td></td> </tr> <tr> <td>85A</td> <td></td> </tr> <tr> <td>90A</td> <td></td> </tr> <tr> <td>100A</td> <td></td> </tr> <tr> <td>115B/C/(L)</td> <td></td> </tr> <tr> <td>130B/(L)</td> <td></td> </tr> <tr> <td>150C/(L)</td> <td></td> </tr> <tr> <td>175B</td> <td></td> </tr> <tr> <td>200B/PRO</td> <td></td> </tr> <tr> <td>200V</td> <td></td> </tr> <tr> <td>225B, (-1993)</td> <td></td> </tr> </tbody> </table>		3A, F4A		4A, F4A		5C		6C/D		8C, F8B		F9.9A/B, FT9.9A		HPDI		FT8D		9.9D		15D		20C/D		25D/J/N/Q		30A/D/G		40H/Q		50D/G		55B		60F		70B		75A		80A		85A		90A		100A		115B/C/(L)		130B/(L)		150C/(L)		175B		200B/PRO		200V		225B, (-1993)		<table border="1"> <thead> <tr> <th>REF</th> <th>OEM</th> </tr> </thead> <tbody> <tr> <td>REC61N-24563-10</td> <td>61N-24563-10</td> </tr> <tr> <td>REC40145</td> <td>65W-24251-00</td> </tr> </tbody> </table>		REF	OEM	REC61N-24563-10	61N-24563-10	REC40145	65W-24251-00													
3A, F4A																																																																																		
4A, F4A																																																																																		
5C																																																																																		
6C/D																																																																																		
8C, F8B																																																																																		
F9.9A/B, FT9.9A																																																																																		
HPDI																																																																																		
FT8D																																																																																		
9.9D																																																																																		
15D																																																																																		
20C/D																																																																																		
25D/J/N/Q																																																																																		
30A/D/G																																																																																		
40H/Q																																																																																		
50D/G																																																																																		
55B																																																																																		
60F																																																																																		
70B																																																																																		
75A																																																																																		
80A																																																																																		
85A																																																																																		
90A																																																																																		
100A																																																																																		
115B/C/(L)																																																																																		
130B/(L)																																																																																		
150C/(L)																																																																																		
175B																																																																																		
200B/PRO																																																																																		
200V																																																																																		
225B, (-1993)																																																																																		
REF	OEM																																																																																	
REC61N-24563-10	61N-24563-10																																																																																	
REC40145	65W-24251-00																																																																																	
<table border="1"> <thead> <tr> <th>REF</th> <th>OEM</th> </tr> </thead> <tbody> <tr> <td>REC35-80365M</td> <td>646-24251-02</td> </tr> </tbody> </table>		REF	OEM	REC35-80365M	646-24251-02	<table border="1"> <thead> <tr> <th>REF</th> <th>OEM</th> </tr> </thead> <tbody> <tr> <td>REC40165</td> <td>67F-24251-02</td> </tr> <tr> <td>REC68V-24563-00</td> <td>68V-24563-00</td> </tr> <tr> <td>REC61A-24563-00</td> <td>61A-24563-00</td> </tr> <tr> <td>REC65L-24563-00</td> <td>65L-24563-00</td> </tr> <tr> <td>REC60V-24251-01</td> <td>60V-24251-01</td> </tr> </tbody> </table>		REF	OEM	REC40165	67F-24251-02	REC68V-24563-00	68V-24563-00	REC61A-24563-00	61A-24563-00	REC65L-24563-00	65L-24563-00	REC60V-24251-01	60V-24251-01																																																															
REF	OEM																																																																																	
REC35-80365M	646-24251-02																																																																																	
REF	OEM																																																																																	
REC40165	67F-24251-02																																																																																	
REC68V-24563-00	68V-24563-00																																																																																	
REC61A-24563-00	61A-24563-00																																																																																	
REC65L-24563-00	65L-24563-00																																																																																	
REC60V-24251-01	60V-24251-01																																																																																	

# FILTRO DE ACEITE

# OIL FILTER

# FILTRO OLIO

# FILTRE A HUILE

REF	OEM
<b>REC61A-13411-00</b>	61A-13411-00
Z250TR	Z300 AETO
DETO	TXR (2004-07)
FETO (2003-07)	L250G-GETOX (2006-10)
250B	
AETO (1993-06)	
L250B	
TXR (2000-03)	
225G-GETOL (1999-03)	



REF	OEM
<b>REC6E5-13411-00</b>	6E5-13411-00
V-Z 200T	Z1200F-FETO (1996-10)
PETO	225D-DETOX (2000-03)
TLR (2001-07)	115 B
Z150 F	BET (1988-02)
TXRA	130BETO (1991-01)
PETOLX (1996-07)	115CETO
175D	TLR
DETO (1996-03)	TXR (1991-13)



REF	OEM
<b>REC6J8-13411-00</b>	6J8-13411-00
25Q-QEO (1990-94)	FETO
50	L (1989-13)
G-GEO-GETOL (1993-07)	70BETO
50H-HR-MDO (1996-02)	B
40V-MH-MD	BEMO (1989-13)
VETO	25J
VE-O (1995-13)	JEQ
40YETO-YETOL (2005-07)	JETO
30DETOL	NEM
DEOS	W (1988-13)
MH (2011-13)	20D
GOLTRA	EM-ML
F	



REF	OEM
<b>REC68F-13440-00</b>	68F-13440-00
LZ	TLR (2001-07)
LZ300	Z250
TR	TXR
AETO-X-V (2004-07)	DETO
Z175TR	X (2003-07)
GETO-X (2002-07)	Z150P
V	TXR
Z200T	PETO (2000-07)
PETO	



REF	OEM
<b>REC35-80365M</b>	646-24251-02
L150	115
L200	130
225	
175	
250	



REF	OEM
<b>REC6G8-13440-00</b>	6G8-13440-00



REF	OEM
<b>REC5GH-13440-60</b>	5GH-13440-60 5GH-13440-50



new

REF	OEM	
<b>REC35-822626Q15</b>	69J-13440-00, 01, 03	3/4" x 16NPT
<b>REC5GH-13440-00</b>	5GH-13440-00, 30, 70	20 x 1.5
<b>REC26-13440-00</b>	N26-13440-00, 02	3/4" x 16 NPT
<b>REC3FV-13440-00</b>	3FV-13440-00, 10, 20, 30	20 x 1.5



## GUÍA FILTROS DE ACEITE OIL FILTER GUIDE GUIDA FILTRO OLIO GUIDE FILTRE A HUILE

	REF
F8A	
F9,9A/B	
FT9,9A (1990+)	
F9,9C (2000+)	
FT9,9D (2000+)	
F15A (2000+)	
F20A(2000+)	
F25A (2000+)/FT25B	
F30A	
F40A (2000+)/F40B (2001+)	
F50A(1999-05)/F50F(-2005)/FT50B (2000+)/FT50C (-2005)/FT50G (-2005)	
F60A (-2005)/F60C(-2005)/FT60B (-2005)/FT60D (-2005)	
F80A (2000+)/F80B	
F100A (2000+)/F100B/F100D	
F(L)115A/F115B/F100F	
F15C (2007+)	
F20B (2007+)	
F25D/G FT25F	
F30B	
F40F	
F50A, FT50C, F50F, FT50G, (2006+)	
FT60B, F60A, F60C, FT60D (2006+)	
F50H/F60F/FT50J/FT60G	
F70A/VX	
CRUISER/DELUXE (2008-11)	
VX SPORT 08/FX HO/FX HO CRUISER 08	
F9,9C (1998), FT9,9D (1999), F15A (1998), F20A (1998), F25A (1998-99), F40A (1999), F40B (2000), F50A (1995-98), FT50B (1998-99), F80A, F100A (1999)	
F(L)150A/F175A/F(L)200A/F(L)200C/F(L)200F/F(L)200G/F(L)225A/F(L)225B/F225C/F(L)250A/F(L)250B/FX SHO/FX SHO CRUISER/FX HO CRUISER/FZR/FZS	
F(L)300A/F(L)350A/F(L)225F/F(L)250D/F(L)300B	
<b>REC6G8-13440-00</b>	
<b>REC5GH-13440-60</b>	
<b>REC3FV-13440-00</b>	
<b>REC35-822626Q15</b>	
<b>REC26-13440-00</b>	
<b>WaveRunner Model Part Number Price</b>	
FX140/FX140 CRUISER/FX160/FX160	
CRUISER/FX-H.O CRUISER/FX-HIGH OUTPUT/VX 1100SPORT & DELUXE	<b>REC5GH-13440-00</b>

YAMAHA

## BOMBA DE INYECCION DE ACEITE

## OIL INJECTION PUMP

## POMPA INIEZIONE BENZINA

## POMPE D'INJECTION D'HUILE

**new**

REF	OEM
REC6R4-13200-02	6R4-13200-00 6R4-13200-01 6R4-13200-02

150 - 200 HP  
V6  
2T/Strokes



**new**

REF	OEM
REC6E5-81900-01	6E5-81900-01

2T/Strokes

Instalada en el depósito  
Installed in the tank  
Installato nel serbatoio  
Installé dans le réservoir



## ACEITE

## OIL

## OLIO

## HUILES

REF	OEM			
REC2TU6	YMD-63021-01	1 L	6	2 STROKES
REC2TU3	YMD-63021-04	5 L	3	TC-W3
REC5W40U6		1 L	6	SAE 5W40
REC5W40U3		5 L	3	
REC10W30U6	YMD-63050-01	1 L	6	SAE 10W30
REC10W30U3	YMD-63050-04	5 L	3	
REC10W40U6	YMD-63060-01	1 L	6	SAE 10W40
REC10W40U3	YMD-63060-04	5 L	3	
REC25W40U3		5 L	3	SAE 25W40





REF	OEM			
RM92-858026QB1U6	92-858026QB1	1 L	6	2 STROKES
RM92-858027QB1U3	92-858027QB1	3,8 L	3	
RM92-8M0086220U6	92-8M0086220	1 L	6	SAE 10W30
RM92-8M0086221U3	92-8M0086221	4 L	3	



# BOMBA DE COMBUSTIBLE

# FUEL PUMP

# POMPA BENZINA

# POMPE À ESSENCE

## BOMBA DE COMBUSTIBLE MECANICA

## FUEL PUMP MECHANICAL

## POMPA BENZINA MECCANICA

## POMPE À ESSENCE MECANIQUE

REF	OEM	2T STROKES	4T STROKES
PAF20-05050000	6AH-24410-00		✓

**new**

- F9.9H (2009+)
- F13.5B (2007-09)
- F15C,E,M (2007+)
- F20B,E,M (2007+)

REF	OEM	2T STROKES	4T STROKES
REC68V-24410-00	68V-24410-00		✓

**new**

- F100B (2003-10)
- F100C (2001-07)
- F90 (2003-04)
- F75A, T (2003-04)
- F100A (2003-06)
- F80A (2002-07)
- F115A, TR, J (2000-10)

REF	OEM	2T STROKES	4T STROKES
REC6E5-24410-03	6E5-24410-01-00		✓

- V4
- V6 (1989-03)

REF	OEM	2T STROKES	4T STROKES
PAF15-07140000	66M-24410-11		✓

- F9.9/13.5/15

REF	OEM	2T STROKES	4T STROKES
REC68T-24410-00-00	68T-24410-00 68T-24410-01		✓

- F6A/B/M (2000-09)
- F8C/M/E/D/PF/G (2000+)
- F9.9F/M/E/G/J/L (2008+)

REF	OEM	2T STROKES	4T STROKES
PAF25-05130000	62Y-24410-04		✓

- F20/25//30/40/45/50/60

REF	OEM	2T STROKES	4T STROKES
PAF4-04090000	67D-24410-03		✓

- F4

REF	OEM	2T STROKES	4T STROKES
REC692-24410-00	692-24410-00 6A0-24410-00 6A0-24410-05 6A0-24410-03 6A0-24410-04		✓

- 25-85HP

REF	OEM	2T STROKES	4T STROKES
REC6A0-24410-04	6A0-24410-00 6A0-24410-01 6A0-24410-02 6A0-24410-03 6A0-24410-04		✓

- 20 - 90 HP (1985-92)

REF	OEM	2T STROKES	4T STROKES
REC6C5-24410-00	6C5-24410-00		✓

- F30B (2009+)
- F40A/D/H/F (2006+)
- F50F/T/H/J/G (2005+)
- F60A/B/C/D/F/G/T (2005+)

YAMAHA

**BOMBA DE COMBUSTIBLE ELECTRICA**

**FUEL PUMP ELECTRIC**

REF	OEM		2T STROKES	4T STROKES
REC68F-13907-01	68F-13907-01	REC66K-14984-00	✓	

  
 VZ, Z150 (2000-07)  
 VZ, Z175 (2001-07)  
 V, L, Z200 (2000-07)

REF	OEM		2T STROKES	4T STROKES
REC63P-13907-03	63P-13907-03 63P-13907-02 63P-13907-01 63P-13907-00	REC63P-14984-00		✓

  
 F150 A/AET/AETU/AETX/AET1/AET2/BET/BETX/DET/DET/DETX  
 F150 TRC/TXRC/TLRC/TR/TLRD/TLR/TLRF/TRG/TXR/TRF (2004+)

REF	OEM		2T STROKES	4T STROKES
REC69J-13907-03	69J-13907-03 69J-13907-02 69J-13907-01 69J-13907-00 69J-13907-04	REC68V-14984-00		✓

  
 F200 A/AETX/AETU  
 F200 TXRA/TXRB/TXRC/TXRD/TR/TXR/TXRF  
 F225 A/AETU/AETX/AET/TXRA/TXRB/TXRC/TXRD/TXRF  
 F225 TXR/TR/TURD/TURC (2002-10)

REF	OEM		2T STROKES	4T STROKES
REC69J-24410-02	69J-24410-02 69J-24410-01 69J-24410-00	REC6P2-14984-00		✓

  
 F200 A/AETX/AET/CETX  
 F200 TXRA/TXRB/TXRC/TXRD/TR/TXR/TXRF  
 F225 A/AETU/AETX/AET/B/BETU/BETX/CET/CETL  
 F225 TXRA/TXRB/TXRC/TXRD/TXR/TXRF/TR/TURD/TURC  
 F250 AET/AETX/AETU/A/BET/BETX/BETU  
 F250 TXR/TURF/TXRF (2002-11)

REF	OEM		2T STROKES	4T STROKES
REC6AW-13907-00	6AW-13907-00 6P2-13907-00	REC6AW-14984-00		✓

  
 F200 C/ CETX (2006-11)  
 F225 B /BETX/CET/CETL (2006-11)  
 F225 BETU/BETX/A/AETU/AETX/TURF/TRG/TXRF (2006-11)  
 F250 A/B/T (2006-11)  
 F350 AET/AETU/AETX/TRG/TURG (2008-11)

**POMPA BENZINA ELETTRICA**

**POMPE À ESSENCE ELECTRIQUE**

REF	OEM		2T STROKES	4T STROKES
REC66K-13907-00	66K-13907-00 65L-13907-00	REC66K-14984-00	✓	

  
 225G (1999-02)  
 250BETO (1997-02)  
 L/SX250 TXR (2000-02)  
 225FETO/FETOX (2003)

REF	OEM		2T STROKES	4T STROKES
REC67H-13907-00	67H-13907-00	REC66K-14984-00	✓	

  
 225G/GETOL/FETO (2002-04)  
 250B/BETO/TXRA (2002-04)

REF	OEM		2T STROKES	4T STROKES
REC60V-13907-00	60V-13907-00	REC66K-14984-00	✓	

  
 Z, LZ 250 (2003-07)  
 Z, LZ 300 (2003-07)

REF	OEM		2T STROKES	4T STROKES
REC68V-13907-00	68V-13907-00 68V-13907-01 68V-13907-02 68V-13907-03 68V-13907-04	REC68V-14984-00	✓	✓

  
 Z, LZ 250DET/TR/FET (2003-07)  
 Z, LZ 300AET/TR/TX (2004-07)  
 LF/FL/F115A,T (2000-06)

REF	OEM		2T STROKES	4T STROKES
REC866169T01	6C5-13907-00	REC6C5-14984-00	✓	

  
 F40D/G/H (2006+)  
 T/FT/F50F/H/T (2005+)  
 T/FT/F60A/B/C/F/T (2005+)  
 F70A (2011+)  
 F75C/T (2005-09)  
 F80A/B/C (2005+)  
 F90A/B/T (2005+)  
 F100D (2005+)

**new**



## MEMBRANAS Y JUNTAS

## DIAPHRAGMS &amp; GASKETS

## MEMBRANA E GUARNIZIONI

## MEMBRANES ET JOINTS

REF	OEM
REC6G1-24411-00	6G1-24411-00

3-15HP



REF	OEM
PAF25-05130005	62Y-24471-00

F25>F80HP



REF	OEM
REC6E0-24411-00	6E0-24411-00

4C/5C/AC



REF	OEM
REC663-24411-00	663-24411-00

25>90HP



REF	OEM
REC6E0-24471-00	6E0-24471-00

4HP



REF	OEM
REC6J8-24471-00	6J8-24471-00

30HP



REF	OEM
REC6G1-24471-00	6G1-24471-00

6-8HP



REF	OEM
REC6E5-24411-00	6E5-24411-00-00

115/150/175/200HP



REF	OEM
REC677-24471-01	677-24471-01

E8D/9.9D/15D



REF	OEM
REC6E5-24471-00	6E5-24471-00

115>250HP



REF	OEM
REC63V-24411-00	63V-24411-00

9.9  
13.5  
15HP



REF	OEM
REC6G1-24431-01	6G1-24431-01

3A/MSH  
6C/CEM/D/DEM/TRV/MSH/CMH  
8C/CEM/TRV/MSH/CMH/MH  
9.9F  
13.5AWH  
15F



REF	OEM
REC677-24411-02	677-24411-02

9.9>15HP



REF	OEM
REC6E0-24434-00	6G1-24431-01

4AC/MSH/AS/A  
5C/CS/CMH

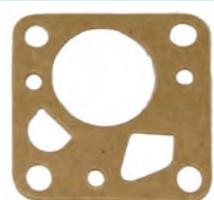

REF	OEM
REC648-24411-00	648-24411-00

20>70HP



REF	OEM
REC6E0-24435-00	6E0-24435-00

4AC/MSH/AS/A  
5C/CS/CMH



REF	OEM
REC692-24411-00	692-24411-00

20>90HP



REF	OEM
REC677-24435-01	677-24435-01

9.9D  
15D

20DM/DEO  
25NE/NEMO

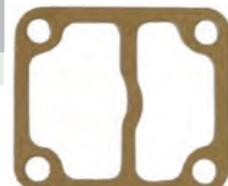

REF	OEM
REC648-24434-01	648-24434-01
 20C/CM 25Q/D/B/BMH 25V/VE E30HMH 30G/H 40V/VM/VE/YE C40 E40 E40X 40X 50G/GEO/GETO/H/D	55B/BE 60FEO/FETO/TLR E60H 70B/BETO 75CETO/AE E75B 80A/AE 85A/AE 90A/AEO/AET



REF	OEM
REC650-24431-A0	650-24431-A0
 25-300HP	



REF	OEM
REC648-24435-02	648-24435-02
 20C/CM 25Q/D/B/BMH 25V/VE E30HMH 30G/H 40V/VM/VE/YE C40 E40 E40X 40X 50G/GEO/GETO/H/D	55B/BE 60FEO/FETO/TLR E60H 70B/BETO 75CETO/AE E75B 80A/AE 85A/AE 90A/AEO/AET



REF	OEM
REC6E5-24435-00	6E5-24435-00
 100A/TLR 115A/ETN/BET/B/BICET/ TLR 130BETO 140AETO 150AETO/ETN/FETO 175AETO/DETO/BETO 200AETO/ETN	V200/G/BETO 220AET 225DET/BETO 250AET Z300



REF	OEM
REC6E5-24434-02	6E5-24434-02
 100A/TLR 115A/ETN/BET/B/BICET/ TLR 130BETO 140AETO 150AETO/ETN/FETO 175AETO/DETO/BETO 200AETO/ETN	V200/G/BETO 220AET 225DET/BETO 250AET Z300



JUNTAS VST      VST GASKETS      GUARNIZIONE VST      JOINTS VST

REF	OEM
REC68V-14984-00	68V-14984-00
 Z, LZ 250DET/TR/FET (2003-07) Z, LZ 300AET/TR/TX (2004-07) LF/FL/F115A,T (2000-06)	



REF	OEM
REC6CB-14984-00	6CB-14984-00
 F115 + (2012+) NEW MODEL	



REF	OEM
REC63P-14984-00	63P-14984-00
 F150 A/AET/AETU/AETX/AET1/AET2/BET/BETX/DET/DET/DETX F150 TRC/TXRC/TLRC/TR/TLRD/TLR/TLRF/TRG/TXR/TRF (2004+)	



REF	OEM
REC6C5-14984-00	6C5-14984-00
 F40D/G/H (2006+) T/FT/F50F/H/T (2005+) T/FT/F60A/B/C/F/T (2005+) F70A (2011+) F75C/T (2005-09) F80A/B/C (2005+) F90A/B/T (2005+) F100D (2005+)	



REF	OEM
REC66K-14984-00	66K-14984-00
 Z, LZ 250 (2003-07) Z, LZ 300 (2003-07)	



REF	OEM
REC6AW-14984-00	6AW-14984-00
 F200 C/ CETX (2006-11) F225 B /BETX/CET/CETL (2006-11) F225 BETU/BETX/A/AETU/AETX/TURF/TRG/ TXRF (2006-11) F350 AET/AETU/AETX/TRG/TURG (2008-11)	

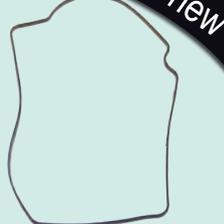

REF	OEM
REC6P2-14984-00	62P-14984-00
 F200 A/AETX/AET/CETX F200 TXRA/TXRB/TXRC/TXRD/TR/TXR/TXRF F225 A/AETU/AETX/AET/B/BETU/BETX/CET/CETL F225 TXRA/TXRB/TXRC/TXRD/TXR/TXRF/TR/ TURD/TURC F250 AET/AETX/AETU/A/BET/ BETX/BETU F250 TXR/TURF/TXRF (2002-11)	



REF	OEM
REC6CB-13016-00	6CB-13016-00
 F115 +	



**REGULADORES DE PRESION COMBUSTIBLE**

**FUEL REGULATOR**

**REGOLATORE BENZINA**

**REGULATEUR DE PRESSION D'ESSENCE**

REF	OEM
REC63P-13906-00	63P-13906-00

F150 (2004+)  
63P/64P/6BM/6BN



*new*

REF	OEM
REC6P2-13906-00	6P2-13906-00

F200 (2006-11)  
6AL / 6AM  
F225 (2007-11)  
6AS/6AT/6BB  
F250 (2006-11)  
6BR/ 6BS/6P



*new*

REF	OEM
REC69J-13906-00	69J-13906-00

F200 (2002-07)  
60L / 60M  
F225 (2005-07)  
69J / 69K



*new*

**INYECTORES**

**INJEKTOR**

**INIETTORE**

**INJECTEURS**

**INJECTOR**

**INJEKTOR**

**INIETTORE**

**INJECTEUR**

REF	OEM
REC6L5-13761-00	65L-13761-00



*new*

REF	OEM
REC6D8-13761-00	6D8-13761-00



*new*

REF	OEM
REC6BG-13761-00	6BG-13761-00



*new*

REF	OEM
REC68V-8A360-00	68V-8A360-00 68V-13761-00



*new*

REF	OEM
REC6C5-13761-00	6C5-13761-00



*new*

REF	OEM
REC6P2-13761-00	6P2-13761-00



*new*



REF	OEM
REC63P-13761-01	63P-13761-00/01



REF	OEM
REC69J-13761-00	69J-13761-00



REF
STA93008 STA93016



REF
GE22207

GUÍA INYECTORES Y SENSORES		GUIDE INJECTORS & SENDERS		GUIDA INIETTORI E SENSORI		GUIDE INJECTEURS ET SONDÉS	
						TPS	MAP
F20 F/G	6GX & 6HY	2017+	REC6FM-13761-00				
F25 G/M	6FM	2017+	REC6FM-13761-00				
F30B	6BT	2009+	REC6BG-13761-00				
F40 A/F	6BG	2009	REC6BG-13761-00				
F40 D/H/G	6AK & 6CY	2006+	REC6C5-13761-00			REC6C5-85885-00	REC68F-83688-00
F50 F/T/H/G/J	6C1 & 6C2	2005+	REC6C5-13761-00			REC6C5-85885-00	REC68F-83688-00
T50 A/B/T	6C2	2005+	REC6C5-13761-00			REC6C5-85885-00	REC68F-83688-00
F60 A/B/C/D/E/F/G/T	6C5 & 6C6	2005+	REC6C5-13761-00			REC6C5-85885-00	REC68F-83688-00
T60 A/B/T	6C6	2005+	REC6C5-13761-00			REC6C5-85885-00	REC68F-83688-00
F70 A	6CJ	2011+	REC6C5-13761-00			REC6C5-85885-00	REC68F-83688-00
F75 T/B	6D61	2005	REC6D8-13761-00			REC6C5-85885-00	REC68F-83688-00
F80 C	6CK	2009-12	REC6D8-13761-00			REC6C5-85885-00	REC68F-83688-00
F80 B	6D7	2005+	REC6D8-13761-00			REC6C5-85885-00	REC68F-83688-00
F100 D	6D9	2005+	REC6D8-13761-00			REC6C5-85885-00	REC68F-83688-00
F115 A/T	68V & 68W	2000-11	REC68V-8A360-00			REC68V-85885-00	REC68V-82380-00
F115A	68V & 68W	2012-15	REC68V-13761-10			REC68V-85885-00	REC68F-83688-10
F115 B	6EK & 6EL	2014+	REC6EK-13761-00			REC6C5-85885-00	REC68F-83688-10
F130 A	6EM	2015+	REC6EK-13761-00				REC68F-83688-10
F150 A/B/C/D/T	63P & 64P	2004-05	REC63P-13761-01	REC63P-13906-00		REC69J-85885-00	REC63P-82380-00
F150 A/T/B/D	63P & 64P	2005+	REC63P-13761-01	REC63P-13906-00		REC6S1-85885-00	REC63P-82380-00
F150 B/F	6BM & 6BN	2012+	REC63P-13761-01	REC63P-13906-00		REC6S1-85885-00	REC63P-82380-00
F150 C/G	6HP & 6HR	2017+	REC6DA-13761-00				REC68F-83688-10
F175 A/C	6FA,6HS,6HT	2014+	REC6DA-13761-00				REC68F-83688-10
F200 A/T	60L & 60M	2000-05	REC69J-13761-00	REC69J-13906-00		REC69J-85885-00	REC68V-82380-00
F200 A/T	60L & 60M	2006-07	REC69J-13761-00	REC69J-13906-00		REC6S1-85885-00	REC68V-82380-00
F200 C	6AL & 6AM	2006	REC6P2-13761-00	REC6P2-13906-00			
F200 A/B/C	6AL,6AM,6S19,6S29	20012+	REC6P2-13761-11	REC6P2-13906-00			
F200 B/F	6DA,6DB,6DV,6DW	2013+	REC6DA-13761-00				REC68F-83688-10
F225 A/T	69J & 69K	2000-07	REC69J-13761-00	REC69J-13906-00		REC69J-85885-00	REC68V-82380-00
F225 A/B/C	6AS,6BB & 6AT	2012-15	REC6P2-13761-11	REC6P2-13906-00			
F250 A/T	6P2 & 6P3	2006-11	REC6P2-13761-00	REC6P2-13906-00			
F250 A/T	6P2 & 6P3	2012-13	REC6P2-13761-11	REC6P2-13906-00			
225G/F	250B	1999-03	REC6L5-13761-00				

CARBURADOR

CARBURATOR

CARBURATORE

CARBURATEUR

CARBURADOR COMPLETO

FULL CARBURATOR

CARBURATORE COMPLETO

CARBURATEUR COMPLET

REF	OEM
REC6F6-14301-06	6F6-14301-06

E40G (2008+)



*new*

REF	OEM
REC6B4-14301-00	6B4-14301-00

E15D (2003+)



*new*

REF	OEM
PAF2.6-04000200	69M-14301-21

F2.5 ALL (2003+)



REF	OEM
PAF4-04140000	67D-14301-03

F4 (1998-05)



REF	OEM
REC6G1-14301-01	6G1-14301-01



REF	OEM
PAF25-05070000	65W-14901-12

F25 ALL (1999-06)

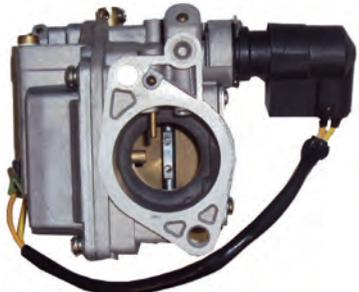

REF	OEM
REC61N-14301-04	61N-14301-04

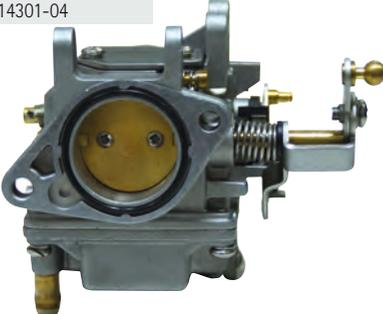

REF	OEM
REC6L5-14301-03	6L5-14301-03



REF	OEM
PAF15-07090000	66M-14301-00
PAF15-07090000W	66M-14301-00

F9.9, F13.5, F15 (1998-07)

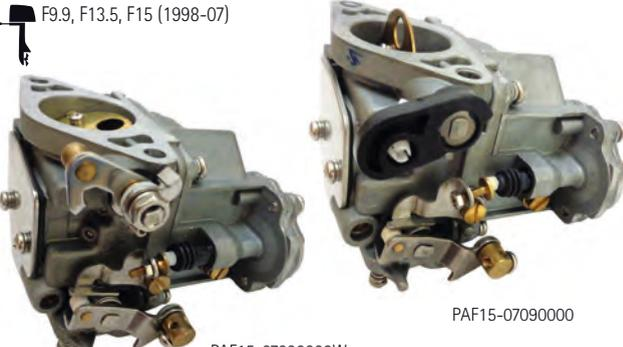

Arranque manual  
Manual starter  
Messa in moto manuale  
Démarrage manuell  
Arranque eléctrico  
Electric starter  
Messa in moto elettrica  
Démarrage électrique

REF	OEM
REC6E3-14301-05	6E3-14301-05



REF	OEM
REC66T-14301-60	66T-14301-60



REF	OEM
REC6A1-14301-03	6A1-14301-03

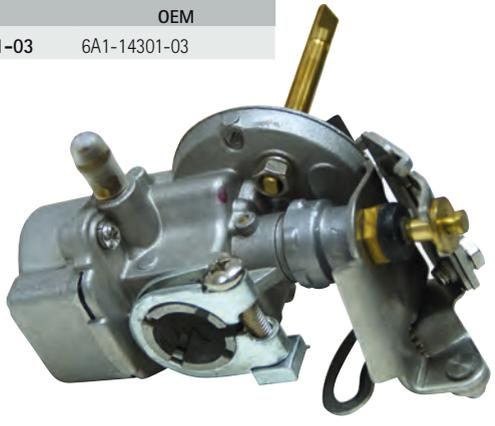

REF	OEM
REC63V-14301-00	63V-14301-00
REC63W-13610-00	



**KIT 3 CARBURADORES**

**KIT 3 CARBURETORS**

**KIT 3 CARBURATORI**

**KIT DE 3 CARBURATEURS**

REF	OEM
REC6K5-14301-03	6K5-14301-03 + 6K5-14302-03 + 6K5-14303-03

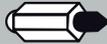

						
			CARB	KIT		
2B, BMHS, MSHA, MSBH, MSHC, MSHD	6A1-6A14	1985-05	REC6A1-14301-03	REC6A1-W0093-01		
3A, AMHL, MSH	6L5	1988-99	REC6L5-14301-03	REC6G1-W0093-00	REC6G1-14985-00	REC6G1-14546-00
3A, AMHS, AMHL, AMH, MSHA, MSBH	6L50-6L59	2001-10	REC6L5-14301-03	REC6G1-W0093-00	REC6G1-14985-00	REC6G1-14546-00
AMH, AMHS	6L5A-6L5F	2011-15	REC6L5-14301-03	REC6G1-W0093-00	REC6G1-14985-00	REC6G1-14546-00
4AS	-6,00E+001	1994-95	REC6E3-14301-05		REC6E7-14385-00	
4AC	-6,00E+000	1994-98	REC6E3-14301-05		REC6E7-14385-00	
4CMHS, CMHL	6GP1	2016	REC6E3-14301-05		REC6E7-14385-00	
5C	-6,00E+003	1986-99	REC6E3-14301-05		REC6E7-14385-00	
5CS	-6,00E+004	1987-95	REC6E3-14301-05		REC6E7-14385-00	
5CMH	6M0	1994	REC6E3-14301-05		REC6E7-14385-00	
5C, CMHS, CMHL	6E30-6E39	2001-10	REC6E3-14301-05		REC6E7-14385-00	
5CMH, CMHS, CMHL	6E3A-6E3F	2011-15	REC6E3-14301-05		REC6E7-14385-00	
6C, CEM	6H6	1984-96	REC6G1-14301-01	REC6G1-W0093-00	REC6G1-14985-00	REC6G1-14546-00
6D, DEM	6H8	1984-96	REC6G1-14301-01	REC6G1-W0093-00	REC6G1-14985-00	REC6G1-14546-00
6J	6H6	1986	REC6G1-14301-01	REC6G1-W0093-00	REC6G1-14985-00	REC6G1-14546-00
6C, MSH, TRV	6M8	1997-98	REC6G1-14301-01	REC6G1-W0093-00	REC6G1-14985-00	REC6G1-14546-00
6C	6M80	2001	REC6G1-14301-01	REC6G1-W0093-00	REC6G1-14985-00	REC6G1-14546-00
6D	6M90-6M91	2001-02	REC6G1-14301-01	REC6G1-W0093-00	REC6G1-14985-00	REC6G1-14546-00
6CMH, CMHS, CMHL, MSHA, MSBH, MSHG, MSHD, MH, MHL, CWH	6M81-6M89	2002-10	REC6G1-14301-01	REC6G1-W0093-00	REC6G1-14985-00	REC6G1-14546-00
CMH, CMHL, CM, MH	6M8A-6M8B	2010-12	REC6G1-14301-01	REC6G1-W0093-00	REC6G1-14985-00	REC6G1-14546-00
8N	6G1	1984	REC6G1-14301-01	REC6G1-W0093-00	REC6G1-14985-00	REC6G1-14546-00
8C, CEM	6G1	1984-95	REC6G1-14301-01	REC6G1-W0093-00	REC6G1-14985-00	REC6G1-14546-00
8J	6G1	1986	REC6G1-14301-01	REC6G1-W0093-00	REC6G1-14985-00	REC6G1-14546-00
8C, TRV, MSH	6N0	1997-98	REC6G1-14301-01	REC6G1-W0093-00	REC6G1-14985-00	REC6G1-14546-00
8C, MSHZ, MSHA	6N00-6N09	2001-10	REC6G1-14301-01	REC6G1-W0093-00	REC6G1-14985-00	REC6G1-14546-00
8CMH, CMHS, CMHL	6N0A-6N0C	2011-12	REC6G1-14301-01	REC6G1-W0093-00	REC6G1-14985-00	REC6G1-14546-00
9.9FMH, FMHS, FMHL, FEMH, MHW, MSH, MSHZ, MSHA, MSBH, MSHC	63V-63V9	1995-10	REC63V-14301-00	REC63V-W0093-00	REC63V-14985-00	REC6G1-14546-00
FMH, FMHS, FMHL, MH	63VA-63VJ	2011-16	REC63V-14301-00	REC63V-W0093-00	REC63V-14985-00	REC6G1-14546-00
13.5AWH	63V	1998	REC63V-14301-00	REC63V-W0093-00	REC63V-14985-00	REC6G1-14546-00
13.5AMH, AMHS, AMHL	66S1-66S2	2003-04	REC63V-14301-00	REC63V-W0093-00	REC63V-14985-00	REC6G1-14546-00
15F.FEMH, FMHS, MHW, MSH, MSHA	63W-63W1	1995-02	REC63V-14301-00	REC63V-W0093-00	REC63V-14985-00	REC6G1-14546-00
E15CMHS	65F2	2003	REC63V-14301-00	REC63V-W0093-00	REC63V-14985-00	REC6G1-14546-00
E15D	6B4	2003+	REC6B4-14301-00	REC63V-W0093-00	REC63V-14985-00	REC6G1-14546-00
15FMHS, FMHL, FMH, MH, MSBH, MSHC, MSHG	63W2-63W9	2003-10	REC63V-14301-00	REC63V-W0093-00	REC63V-14985-00	REC6G1-14546-00
15FMHS, FMHL, FMH, MH	63WA-63WG	2011-16	REC63V-14301-00	REC63V-W0093-00	REC63V-14985-00	REC6G1-14546-00
25VE	61R	1996	REC61N-14301-04	REC61N-W0093-00	REC6L2-14385-00	REC61N-14392-00
25VM	61R	1997	REC61N-14301-04	REC61N-W0093-00	REC6L2-14385-00	REC61N-14392-00
E25A	61N	1998	REC61N-14301-04	REC61N-W0093-00	REC6L2-14385-00	REC61N-14392-00
25VM	61R0	2001	REC61N-14301-04	REC61N-W0093-00	REC6L2-14385-00	REC61N-14392-00
30G	61T	1996	REC61N-14301-04	REC61N-W0093-00	REC6L2-14385-00	REC61N-14392-00
30GE	61T	1997	REC61N-14301-04	REC61N-W0093-00	REC6L2-14385-00	REC61N-14392-00
40X, XW	66T	1998-00	REC66T-14301-60	REC66T-W0093-01	REC6E5-14385-02	REC6E5-14546-00
40XMH	66T4-66T8	2003-05	REC66T-14301-60	REC66T-W0093-01	REC6E5-14385-02	REC6E5-14546-00
40XMH, XMHS, XMHL	66TG-66TR	2009-12	REC66T-14301-60	REC66T-W0093-01	REC6E5-14385-02	REC6E5-14546-00
E40X, MLH	66T	1998-00	REC66T-14301-60	REC66T-W0093-01	REC6E5-14385-02	REC6E5-14546-00
E40X, XMH, XMHS, XMHL, MLHZ	66T0-66T8	2001-05	REC66T-14301-60	REC66T-W0093-01	REC6E5-14385-02	REC6E5-14546-00
E40X, XMHS, XMHL, XMHL, XMHLX	66TA-66TR	2006-12	REC66T-14301-60	REC66T-W0093-01	REC6E5-14385-02	REC6E5-14546-00
E60H, HMHD, HMHDS, HMHDL, ELHB, MHZ, MLHA, HMHDX, HWH	69D0-69D9	2001-10	REC6K5-14301-03	REC6H3-W0093-02	REC6G1-14985-00	REC6H3-14590-00
E60HMHD, HMHDS, HMHDL, HWDL	69DA-69DC	2011-12	REC6K5-14301-03	REC6H3-W0093-02	REC6G1-14985-00	REC6H3-14590-00
E60HE, HM, E-60H	6K5	1996-00	REC6K5-14301-03	REC6H3-W0093-02	REC6G1-14985-00	REC6H3-14590-00

JUNTAS CARBURADORES

CARBURETOR GASKETS

GUARNIZIONI CARBURATORI

JOINTS DE CARBURATEUR

REF	OEM
REC6H4-14984-00	6H4-14984-00
	25 - 90 HP



*new*

REF	OEM
REC6F5-14483-00	6F5-14483-00
	E40/40J (2003+)



*new*

REF	OEM
REC6F5-14384-00	6F5-14384-00
	E40GMH/JMH 40GWH/JWH



REF	OEM
REC6F5-14398-00	6F5-14398-00
	E40GMH/JMH 40GWH/JWH



REF	OEM
REC677-14384-01	677-14384-01
	E8D/DMH 9.9D 15D



REF	OEM
REC677-14227-00	677-14227-01
	E8D/DMH 9.9D 15D



REF	OEM
REC6E7-14227-00	6E7-14227-00
	9.9D 15D



REF	OEM
REC63V-14984-00	63V-14984-00
	9.9F/FM/FEM/MS/MH/E9.9DMH 13.5AW 15F/FEM/MSH/FMH/MH E15DMH



REF	OEM
REC63V-14126-00	63V-14126-00
	9.9F/FM/FEM/MS/MH/E9.9DMH 13.5AW 15F/FEM/MSH/FMH/MH E15DMH



REF	OEM
REC6L2-14399-00	6L2-14399-00
	20DM/D/DEO/MLH E25A 25VE/VM/B/BMH/BWH/HMH/NMH/NE/N/ MLH/D 30G/GE E30HMH



REF	OEM
REC6L2-14384-00-00	6L2-14384-00
	20DM/D/DEO/MLH E25A 25VE/VM/B/BMH/BWH/HMH/NMH/NE/N/ MLH/D 30G/GE E30HMH



REF	OEM
REC648-14384-01-00	648-14384-01
	20C/CM 25D/DE 30A



REF	OEM
REC6H3-14457-01	6H3-14457-01
	25Q 40V/TLR/H C40T 50G/H
	E60H 60F/TR 70B



REF	OEM
REC66T-14384-01	66T-14384-01
	E40XM/X/MLH/XW 40XW/XM



REF	OEM
REC66T-14536-01	66T-14536-01
	40X/E40X/E40M



REF	OEM
REC676-14984-00-00	676-14984-00
	75A/AE/AET/AEM E75B 85A/AE/AET/AED

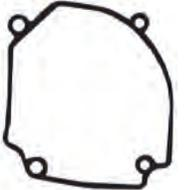

REF	OEM
REC64D-14384-1	64D-14384-01
	100A/AETO/TLR 115A/B/BE/CE/BETO 130BETO 140AETO 150CET/ETD/AETO/ CETO 175AETO/BETO/ET 200ETD 200CETO/AET/BET 225BET/AET 175D/DET
	150F/FET/TXR/AET 200AET/TLR/F/FET 225D/DET 115B/CET/TXR/TLR 130BET 250G/GET





**KITS CARBURADORES**

**CARBURETOR KITS**

**KIT CARBURATORI**

**KIT CARBURATEUR**

REF	OEM
REC6A1-W0093-01	6A1-W0093-01
 2B (1985-1988)	

REF	OEM
REC677-W0093-00	677-W0093-00
 9.9D (1985) 15D (1985)	

REF	OEM
REC6G1-W0093-00	6G1-W0093-00
 3A/AMH//MSH/ (1988-07) 6C/CEM/N/J (1984-96) 8C/CEM/N/J (1984-96)	

REF	OEM
REC6E7-W0093-01	6E7-W0093-04
 9.9D (1990-93) 15D (1990-93)	

REF	OEM
REC67D-W0093-00	67D-W0093-00
 F4 (1999-02) F4A/AMH/MSH (1998-02)	

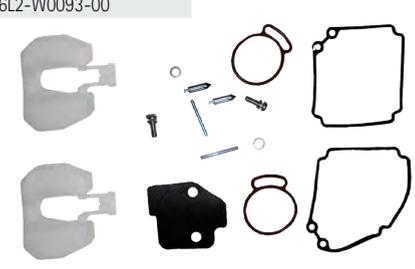
REF	OEM
REC6L2-W0093-00	6L2-W0093-00
 20D/M (1998-11) 25N/M (1988-14)	

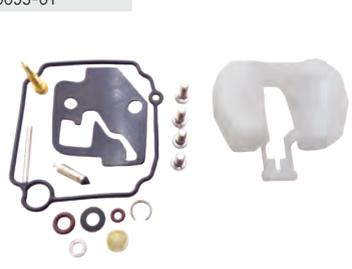
REF	OEM
REC66M-W0093-01	66M-W0093-01
 F9.9C/FT9.9D (1998-08) F15A/ELH/MHZ/PL (1998-07)	

REF	OEM
REC689-W0093-02	689-W0093-02
 20C/CM (1992-02) 25D/DE (1992-01) 30A (1992)	

REF	OEM
REC63V-W0093-00	63V-W0093-00
 9.9MH/FMH (1995-12) E9.9 13.5AMH (2003-04) 15FMH/MH (1995-12) E15DMH (2003)	

REF	OEM
REC8542561	65W-W0093-02
 F20A (2006-09) F25A/E (2006-09) FT/T25B/T (2006-09) F40B (2006-09) F30A (2006-09)	

**new**

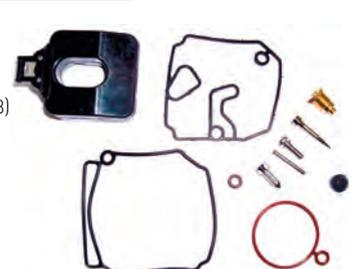
REF	OEM
REC6H4-W0093-03	6H4-W0093-03
 25QEO (1993-1994) 40V/VM/VE (1995-14) C40T/TL (1995-02) 40YET (2005-07) 50H/HR/HM/HW/HE (1995-03)	

REF	OEM
REC6E9-W0093-02	6E9-W0093-02
 40G/QE/QE-2/QM (1992-99)	

REF	OEM
REC6H2-W0093-10	6H2-W0093-10
 25B/BETO (1994-1995) 50G/GE (1993-1998) 60FE/TL/TR (1992-2007) 70B/BE (1992-2014)	

REF	OEM
REC6F6-W0093-00	6F6-W0093-00
 E40 (2003)	

REF	OEM
REC61N-W0093-00	61N-W0093-00
 25VE/VM (1996-01) 25B/BMH/BW (2001-10) E30HMH (2003) 30G/GE (1996-00) 30HMH/HW (2003-12)	

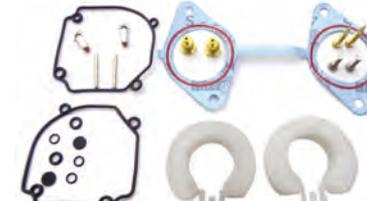
REF	OEM
REC6E9-W0093-03	6E9-W0093-03
 40QEZ/QWC (1997-98) C40 2Cyl (1995-98)	

REF	OEM
REC6H4-W0093-01-00	6H4-W0093-01
 40H/E (1985-88) 50D (1985-88)	

REF	OEM
REC696-W0093-00	696-W0093-02
 E48CMH (2003) 55B/BE/BM (1992-02) E55CMH (2003-05)	
Para dos carburadores For two carburetors Contenuto per due carburatori Pour 2 carburateurs	

REF	OEM
REC66T-W0093-01	66T-W0093-01
 40XMH/XW (2000-13) E40X/MLH/XM (2000-13)	

REF	OEM
REC84419M	696-W0093-01 696-W0093-02
 E48CMH (2003) 55B/BE/BM (1992-02) E55CMH (2003-05)	

new

REF	OEM
REC6H1-W0093-01-00	6H1-W0093-01
	60FE-T/FEO (1985-91) 70B/BEH/CEL (1985-90)



REF	OEM
REC6N6-W0093-02	6N6-W0093-02
	115BETO/CETO (1990-91) L/130 BETO (1990-91)



REF	OEM
REC6H3-W0093-02	6H3-W0093-02
	E60H/MHZ/MLH/HMHD/HW/ HEHM (1997-14)



REF	OEM
REC6E5-W0093-08	6E5-W0093-08
	115 BE (1997)



REF	OEM
REC6H0-W0093-00	6H0-W0093-00
	C80 (1997)

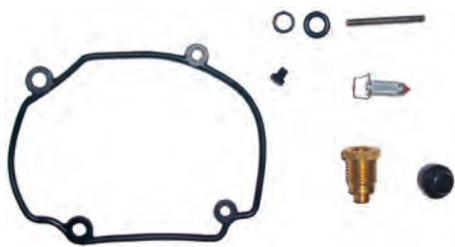

REF	OEM
REC6E5-W0093-06	6E5-W0093-06
	115B/BETO/CEO/CETO (1992-1995) 130BETO (1993-1995) L150CETO (1992-1995) 175BETO (1992-95) 200BETO (1992-95) 200CETO (1992-93) 225BETO (1993-95)



REF	OEM
REC6H1-W0093-10	6H1-W0093-10
	75CET (1998-2014) 75TLR (2000-02) 80A (2000-02) 90AE/TR/TL (1992-14)



REF	OEM
REC64D-W0093-00	64D-W0093-00
	150A/AET/GET/FET/F (1996-00) 175DET/FET (1996-00) 200F/FET/G/GET (1996-00) 225D/DET (1996-97)



REF	OEM
REC67F-W0093-00	
	F80A/TLR/ (1999-2001) F100A/TLR/TRZ/TLR (1999-2001)

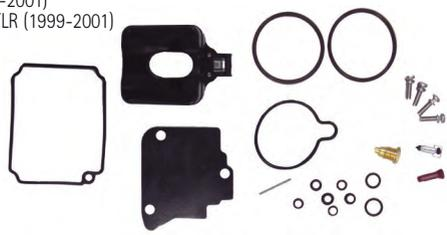

REF	OEM
REC6K7-W0093-09	6K7-W0093-09
	225AET (1987-91) PROV200 (1991) 150CET (1990-91) 175 BETO (1990-91) 200BET/ET (1990-91) 225BET(1990-91)



REF	OEM
REC6E5-W0093-07	6E5-W0093-07
	115BE/B (1996-2002) 115C/CET (2007-13) 130B/9BET (2007)



REF	OEM
REC61A-W0093-01	61A-W0093-01
	225C/CET (1994-95) 250B (1995-02) 250A/AET (1992-06)



**AGUJA CARBURADOR**

**NEEDLE VALVE**

**SPILLO CONICO CARBURATORE**

**SIEGE, POINTEAU ET GICLEUR**

REF	OEM
REC61N-14392-00	62Y-14392-00

2.5>60HP



REF	OEM
REC6G1-14546-00	6G1-14546-01

8>40HP



REF	OEM
REC626-14390-90	626-14390-90

9.9D/15D



REF	OEM
REC677-14343-68	677-14343-68

9.9D/15D



REF	OEM
REC6E8-14390-12	6E8-14390-12

9.9-15HP  
E8D/9.9D/15D



REF	OEM
REC6E5-14546-00	6E5-14546-00

25-250HP



REF	OEM
REC6F5-14390-21	6F5-14390-21

40G/E40G  
40J/E40J



REF	OEM
REC6F6-14341-00	6F6-14341-00

40G/40J  
E40G/E40J



REF	OEM
REC696-14590-01	696-14590-01

48-55HP  
E48CMH  
E55CMH



REF	OEM
REC6H3-14590-00	6H3-14590-01

E60/60FE/TR  
70BET/TR  
F80-F100



REF	OEM
REC688-14947-00	688-14947-00

75A/AE  
85A/AE



REF	OEM
REC692-14590-01	692-14590-00 692-14590-01

75A,C,TLR (1990-16)  
80A (1984-02)  
85A (1990-03)  
90A,T (1984-18)



**new**

**TORNILLOS CARBURADOR**

**BOLT SCREW**

**VITE CARBURATORE**

**VIS DE CARBURATEUR**

REF	OEM
REC624-42542-00	90387-06119

3>300HP



REF	OEM
REC647-14323-00	647-14323-00

E8D  
4A/MS  
9.9D  
20C

5C  
15D  
25D  
30A



REF	OEM
REC6F5-14323-00	6F5-14323-01

E40G/E40J  
40G/40J



REF	OEM
REC692-14923-00	692-14923-00

40>90HP



REF	OEM	
REC679-14923-00	679-14923-00	
 9.9F/M E9.9D 15F/M E15D	13.5 AM 8N/C/J 6C/D/TR/M 3A	

REF	OEM	
REC663-14923-00	663-14923-00	
 E48C 55B E55CMH		

REF	OEM	
REC6A0-14325-00	6A0-14325-00	
 15>300HP		

REF	OEM	
REC6E5-14328-01	6E5-14328-01	
 115>225HP		

REF	OEM	
REC50M-14355-00	50M-14355-00	
 20>50HP		

REF	OEM	
REC64D-14394-00	64D-14394-00	
 115-225HP		

REF	OEM	
REC66T-14992-00	66T-14992-00	
 40X/E40X/E40M		

REF	OEM	
REC6E5-14323-03	6E5-14323-03	
 115>250		

VÁLVULA DE LÁMINAS    VALVE OF SHEETS    VALVOLA    CLAPET D'ADMISSION

REF	OEM	
REC6F6-13610-00	6F6-13610-00	
 40G/E40G 40J/E40J		

REF	OEM	
REC688-13610-00	688-13610-00	
 75A,C,T / E75 (1990+) 80A (1984-02) 85A (1900+) 90A,TR,TLR (2003+) 2T/Strokes		<b>new</b>

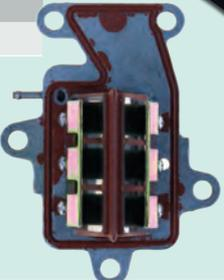
REF	OEM	
REC63W-13610-00	63W-13610-00	
 9.9/15 HP (1995+) 2T/Strokes		<b>new</b>

PASADOR DE BOYA    PIN FLOAT    SPINOTTO GALLEGGIANTE    AXE DE FLOTTEUR

REF	OEM	
REC688-14548-00	688-14548-00	3>90HP
REC676-14186-00	676-14186-00	3>100HP 4AC/M/AS FT/F9.9A/B 5C/CM/CS
REC647-14386-10	647-14386-10	T9.9EL 9.9D F8AM/BM 15D
PAF25-05070019	6H4-14548-00	9.9>100HP
REC6E5-14386-01	6E5-14386-01	9.9>200HP

REF	OEM	
REC663-14548-00	663-14548-00	E48C 55B E55CMH
REC6E5-14386-02	6E5-14386-02	115>200HP



**BOYAS**                      **FLOATS**                      **GALLEGGIANTE**                      **FLOTTEUR DE CARBURATEUR**

REF	OEM
REC6G1-14985-00	647-14323-00

3A/M	70B
E60	40N-H
8C-M/T	50E-D
60F	6C/M/D



REF	OEM
REC648-14385-00	648-14385-00

20C
25D
30A



REF	OEM
REC647-14385-00	647-14385-00

4AC
5C
9.9D
15D



REF	OEM
REC6F6-14385-00	6F6-14385-00

40G/J
E40G/J



REF	OEM
REC6E7-14385-00	6E7-14385-00

4AC
5C
E8D
9.9D
15D



REF	OEM
REC676-14985-01	676-14985-01

40Q
75A
E75B
80A
85A
90A/E



REF	OEM
REC676-14966-00	679-14966-00

8>100HP
---------



REF	OEM
REC6E5-14385-02	6E5-14385-02

40X	175D/A
E40	200A
100A	200G/F/B
115C	225D
115A-B	225A
130B	250G
150F/A	



REF	OEM
REC63V-14985-00	63V-14985-00

9.9F-M
13.5A
15F-M
F20
F25
F30
F40



REF	OEM	2T STROKES	4T STROKES
REC6H4-14985-01	6H4-14985-00	✓	✓
	6H4-14985-01		
	650-14385-00	25-90 hp	75-100 hp
	6M6-14385-00		



**new**

REF	OEM
REC6L2-14385-00	6L2-14385-00

13.5>60HP
-----------



**CONECTOR DE CARBURADOR**                      **ACCELEROGRAPH CONTROL**                      **CONTROLLO DELL'ACCELEROGRAFO**                      **ATTACHE TIGE D'ACCELERATEUR**

REF	OEM
PAF15-07000016	661-41262-01
	661-41262-02



**new**

**ELEMENTO FILTRO DEL  
CARBURADOR**

**ELEMENT  
FILTER (CARB INLET)**

**FILTRO CARBURATORE**

**FILTRE DU CARBURATEUR**

REF	OEM
REC67F-14371-01	67F-14371-01
 F75	(2003-04)
 F80	(2002-03)
 F90	(2003-04)
 F100	(2002-03)



**ACCELERADOR**

**ACCELERATOR**

**ACCELERATORE**

**ACCELERATEUR**

**VARILLA DE ACELERADOR**

**ROD ACCELERATOR LEVER**

**ASTA ACCELERATORE**

**TIGE LEVIER  
ACCELERATEUR**

REF	OEM
REC6H3-41217-00	6H3-41217-00
 50G/E60H	
 60F/T	
 70B/T	



REF	OEM
REC692-41256-00	692-41256-00
 75A/B	
 80A	
 85A	
 90A	



REF	OEM
REC688-41217-00	688-41217-00
 80A	
 90A/E	



REF	OEM
REC6G5-41217-00	6G5-41217-01
 150/200ETN	
 150/200AETO	
 175AET-0	
 225AETO	



# SISTEMA ELÉCTRICO ELECTRIC SYSTEM

# SISTEMA ELETTRICO SYSTÈME ÉLECTRIQUE

## SENSORES

## SENSORS

## SENSORE

## CAPTEURS

### SENSOR TPS

### TPS SENDER

### SENSORE TPS

### CAPTEUR TPS

REF	OEM
REC6C5-85885-00	6C5-85885-00



*new*

REF	OEM
REC6S1-85885-00	6S1-85885-00



*new*

REF	OEM
REC69J-85885-00	69J-85885-00



*new*

REF	OEM
REC68V-85885-00	68V-85885-00



*new*

### SENSOR MAP

### MAP SENSOR

### SENSORE MAP

### CAPTEUR MAP

REF	OEM
REC68V-82380-00	68V-82380-00



*new*

REF	OEM
REC68F-83688-10	68F-83688-10



*new*

REF	OEM
REC63P-82380-00	63P-82380-00



*new*

REF	OEM
REC68F-83688-00	68F-83688-00



*new*

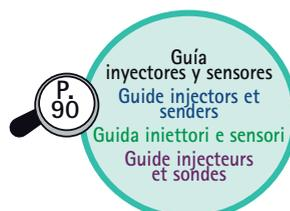



SENSOR TEMPERATURA DEL AGUA		SENSOR, WATER TEMPERATURE		SENSORE TEMPERATURA ACQUA		CAPTEUR DE TEMPERATURE	
REF	OEM			REF	OEM		
PAF25-05010201	65W-85790-00			PAT40-05000100	6AH-82560-00		
							
<ul style="list-style-type: none"> <li>F20A (1998-06)</li> <li>F25A,E,M (1998-09)</li> <li>T25 / FT25 (1998-09)</li> </ul>				<ul style="list-style-type: none"> <li>F9.9H (2009+)</li> <li>F13.5B (2007-09)</li> <li>F15C,E,M (2007+)</li> <li>F20B, E, M (2007+)</li> </ul>			

REF	OEM	2T STROKES
REC688-82560-10	688-82560-10	40 - 300 hp (1984-16)



SENSOR ACCELERACIÓN TS		SENSOR		SENSORE ACCELERATORE TS		CAPTEUR D'ACCELERATEUR TS	
REF	OEM	2T STROKES	4T STROKES				
REC6X2-85885-10	6X2-85885-10 61A-85885-00	✓	✓				
<ul style="list-style-type: none"> <li>80 - 300 HP</li> </ul>							

SENSOR PRESIÓN DE ACEITE		SENSOR, OIL PRESSURE		SENSORE PRESIONE DELL'OLIO		SONDE DE PRESSION D'HUILE	
REF	OEM						
PAF15-07010103	65W-82504-00 62Y-82504-10						
<ul style="list-style-type: none"> <li>F9.9 - F40</li> </ul>							

SENSOR DE OXÍGENO		OXYGEN SENSOR		SENSORE OSSIGENO		SONDE À OXYGENE	
REF	OEM			REF	OEM		
REC67H-8592A-01	67H-8592A-01			REC68F-8592A-00	68F-8592A-00		
<ul style="list-style-type: none"> <li>LX200/SX200 (2001-05)</li> <li>DX150/LX150 (2001-05)</li> <li>SX150/VX150 (2001-05)</li> </ul>				<ul style="list-style-type: none"> <li>200HP (2001-2007)</li> <li>150HP (2001-2007)</li> <li>175HP (2001-2007)</li> <li>L, Z, V-PETO, TLR, NETO</li> </ul>			

BOBINAS

COILS

BOBINE

BOBINES

BOBINA DE LUZ

COIL LIGHTING

BOBINA LUCE

BOBINE D'ÉCLAIRAGE

REF	OEM	2T STROKES	4T STROKES
REC63V-85533-00	63V-85533-00	✓	
	9,9/15 F/M (1995+) 13,5 AM (2003-04) E9.9/15 (2003)		



REF	OEM	2T STROKES	4T STROKES
REC66T-85533-00	66T-85533-00	✓	
	E40 (1998+) 40X/M (1998+)		



REF	OEM	2T STROKES	4T STROKES
PAF15-07000400	66M-85533-00		✓
	F15 ALL (1998-07) F9.9 ALL (1998-08) F13.5 ALL (2002-07)		



BOBINA DE IGNICIÓN

IGNITION COIL

BOBINA AVVIAMENTO

BOBINE D'ALLUMAGE

REF	OEM	2T STROKES	4T STROKES
REC6E0-85570-00	6E0-85570-00	✓	
	4A/M/C (1996-18) 5C (1996-15)		



*new*

REF	OEM	2T STROKES	4T STROKES
REC6H3-85570-10	6H3-85470-10	✓	
	E60H/M (2001+) 60F (1984-91) 70B/C/E (1984-91)		



*new*

REF	OEM	2T STROKES	4T STROKES
REC6B4-85570-01	6B4-85570-00 6B4-85570-01	✓	
	E9.9D (2003-13) E15D (2003+)		



*new*

REF	OEM	2T STROKES	4T STROKES
REC6R3-85570-01	6R3-85570-01	✓	
	200 A/E/F (1997-10) 150 F/T (1994-07) 175D (1996-03) 225D (1996-09) 130 B/T (1994-07) 115 C/T (1994-13) 130 BETO (1994-01)		



REF	OEM	2T STROKES	4T STROKES
PAF25-05120000	65W-85570-01		✓
	F20A/E (1998-06) F25A/B/T/M (1998-09)		



REF	OEM	2T STROKES	4T STROKES
PAF15-07000600	66M-85570-00		✓
	F15 ALL (1998-07) F9.9 ALL (1998-08) F13.5 ALL (2002-07)		



REF	OEM	2T STROKES	4T STROKES
REC6F5-85570-11	F5-85570-13		✓

 F9.9 (2009+)  
 F20/25 B/F (2007+)  
 F13.5 B/M (2007+)  
 F15 C/M/E (2007-09)



REF	OEM	2T STROKES	4T STROKES
REC63V-85570-00	63V-85570-00 65E-85570-00	✓	

 9.9/15/13.5 (1995+)  
 E15 (2003) 65F & 65G  
 9.9/15 F/M (1995-13)  
 13.5A (2003-04)  
 E15 (2003)



REF	OEM	2T STROKES	4T STROKES
REC697-85570-00	697-85570-00	✓	✓

 50G/ETOL (1995-07)  
 75T/L/A/C/B (1997-14)  
 85A/E/TDL/X (1997-03)  
 55 B/M/ET (1995-02)  
 90A/T/ETOL (1997-14)  
 60F/T/ETOL (1995-07)  
 70B/E/ETOL (1995-14)



REF	OEM	2T STROKES	4T STROKES
REC689-81311-40	66M-85570-00	✓	

 3A (1985-92)  
 40Q (1990-98)



REF	OEM	2T STROKES	4T STROKES
REC61N-85570-01	61N-85570-00 61N-85570-01		✓

 20 D, DEM, MLH, MSH, DMH, DWQ, DWH (6L3 - 6L3A) (1994-11)  
 E25 A (61N) (1998)  
 25B, BMH, BWC, BWHVM (61R0 - 69RG) (2001-15)  
 E25 BMH (63P3 - 69PG) (2003-15)  
 25 N, NE, MLH, MSH, NMH, NW, MH (6L2 - 6L2G) (1994-15)  
 30 G, C30 ELRW (61T - 61T0) (1998-01)  
 330 HMH (60B3) (2003)



REF	OEM	2T STROKES	4T STROKES
REC6E5-85570-11	6E5-85570-11 6E5-85570-10	✓	

 115HP 4Cil. (1984-91)  
 140A/E (1984-89)  
 150  
 175  
 200HP (1984-89)



REF	OEM	2T STROKES	4T STROKES
REC6A1-85570-00	6A1-85570-00	✓	

 2B,C,M (1995-10)



REF	OEM	2T STROKES	4T STROKES
REC67F-85570-00	67F-85570-00	✓	

 F80A/T (67G-67G5) (1999-06)  
 F100A/B/C/T (2003-12)



REF	OEM	2T STROKES	4T STROKES
REC697-85570-10	697-85570-11	✓	

 55HP 2 Cil. (1989-94)  
 90A/ETN/AETO (1984-88)  
 80A (1984-89)



REF	OEM	2T STROKES	4T STROKES
REC66T-85570-00	66T-85570-00	✓	

 E40 (1998+)  
 40X/M (1998+)



REF	OEM	2T STROKES	4T STROKES
REC6F6-85530-01	6F6-85530-01	✓	

**new**

EK40G (2018)  
E40G (2006+)

REF	OEM	2T STROKES	4T STROKES
REC6E7-85570-19	6E7-85570-19-00	✓	

9.9/15HP (1988-95)  
20C/D (1985-93)  
25C/D (1985-93)

**BOBINA DE T.C.I. T.C.I. COIL**

REF	OEM	2T STROKES	4T STROKES
PAF2.6-04000600	69M-85640-00		✓

F2.5 ALL (2003+)

**BOBINE T.C.I. BOBINE T.C.I.**

REF	OEM	2T STROKES	4T STROKES
PAF4-04000038	67D-85640-00		✓

F4 ALL (1998+)

**BOBINA DE CARGA CHARGE COIL**

REF	OEM	2T STROKES	4T STROKES
REC63V-85520-00	63V-85520-00	✓	

F15 (1995+)  
9,9 F/M (1995+)  
13,5 A (2003-04)

**BOBINA DI CARICA BOBINE DE CHARGE**

REF	OEM	2T STROKES	4T STROKES
REC66T-85520-00	66T-85520-00	✓	

E40 (1998+)  
40X/M (1998+)

REF	OEM	2T STROKES	4T STROKES
PAF15-07000300	66M-85520-00		✓

F15 ALL (1998-07)  
F9.9 ALL (1998-08)  
F13.5 ALL (2002-07)

REF	OEM	2T STROKES	4T STROKES
REC69P-85541-09	69P-85541-09	✓	

E25 B, BMH (69P1 - 69PG) (2001-15)  
25 B, BMH, BWC, BWH, MWS (69R1 - 69RG) (2001-15)  
E30 HMH (60B3) (2003)  
30 H, HMH, HWH, HWS, HWL, HW, HWC (69S3 - 69SG) (200315)

REF	OEM	2T STROKES	4T STROKES
REC6H3-85520-00	6H3-85520-00	✓	

E60H/M (2001+)  
60F (1984-91)  
70B/C/E (1984-91)



**new**

REF	OEM	2T STROKES	4T STROKES
REC6B4-85520-00	6B4-85520-00	✓	

E9.9D / E15D



**new**

### BOBINA DE PULSACIÓN

### PULSER COIL

REF	OEM	2T STROKES	4T STROKES
PAF20-05000100	6AH-85580-00		✓

F9.9H (2009+)  
F13.5B (2007-09)  
F15C/E/M (2007)  
F20/F30 (2009+)



**new**

REF	OEM	2T STROKES	4T STROKES
REC6B4-85580-00	6B4-85580-00	✓	

E9.9D / E15D



**new**

REF	OEM	2T STROKES	4T STROKES
PAF25-05110000	65W-85580-00		✓

F25 ALL (1998-09)  
F40 E  
B (2000-09)  
F30 A  
ERZ  
ML (2001-09)



### BOBINE ACCENSIONE

### BOBINE PULSEUR

REF	OEM	2T STROKES	4T STROKES
REC63V-85580-01	63V-85580-01	✓	

9,9/15 F/M (2003+)  
13,5A (2003-04)



REF	OEM	2T STROKES	4T STROKES
REC66T-85580-00	66T-85580-00	✓	

E40 (1998+)  
40X/M (1998+)



REF	OEM	2T STROKES	4T STROKES
PAF15-07000200	66M-85580-00		✓

F15 ALL (1998-07)  
F9.9 ALL (1998-08)  
F13.5 ALL (2002-07)



**BUJÍAS**

**SPARK**

**CANDELE**

**BOUGIES**

2T STROKES		REF CHAMPION	OEM
2	1984	CHAL90C	94703-00001
3	1988	CHAQL86C	94701-00248
5	1984	CHAQL82C CHAL82C	94701-00041
6	1986	CHAQL82C CHAL82C	94701-00041
8	1984	CHAQL82C CHAL82C	94701-00041
09/09/19	1984	CHAQL82C CHAL82C	94701-00041
20	1996	CHAQL82C CHAL82C	94701-00041
25	1999	CHAQL82C CHAL82C	94701-00041
30	1984	CHAQL82C CHAL82C	94701-00041
40	1984	CHAQL82C CHAL82C	94701-00041
50	1995	CHARA8HC	94701-00041
70	1984	CHAQL78C	94701-00195
90B	1984	CHAQL78C	94701-00195
90	1984-00	CHAQL78C	94701-00195
115	1984-05	CHAQL78C	94701-00195
130	1989	CHAQL78C	94701-00195
150 Carb	1996	CHAQL82C CHAL82C	94701-00248
150 EFI	1999-00	CHAQL78C	94701-00195
150 EFI	2000	CHARC12YC	94702-00401
150 MPDI	2000	CHARC12YC	94702-00401
150 VMAX	1997	CHAQL78C	94701-00195
175	1984	CHAQL78C	94701-00195

2T STROKES		REF CHAMPION	OEM
175 VMAX	1992	CHAQL78C	94701-00195
200 LX	1999	CHAQL78C	94701-00195
200 LZ	1999	CHARC9YC4	94702-00399
200 SX	1999	CHAQL78C	94701-00195
200 VX	2000	CHAQL78C	94701-00195
200 Z	2000	CHARC9YC4	94702-00399
225	2000	CHAQL77JC4 CHAL77JC4	94701-00309 94701-00217
250	2000	CHAQL77JC4 CHAL77JC4	94701-00309 94701-00217

4T STROKES		REF CHAMPION	OEM
2,5F	2003	CHAQL86C	94701-00248
4F	1999	CHAQL86C	94701-00248
9.9Fi	1996	CHAZ9Y	94701-00282
9.9T	1996	CHAZ9Y	94701-00282
15F	1999	CHARA8HC	94701-00375
25F	1998	CHARA8HC	94701-00375
30F	2001	CHARA8HC	94701-00375
40F	1999	CHARA8HC	94701-00375
50F	1999	CHARA8HC	94701-00375
60	2002	CHARA8HC	94701-00375



	REF NGK	OEM
2B	NGKBR5HS	94702-00249-00
F2,5A/F4A	NGKBR6HS	94701-00248-00
3A/F6A/F8C/FT8D/F9,9F/F9,9J/FT9,9G/FT9,9L	NGKBR6HS-10	94702-00274-00
F4B/F5A/F6C	NGKCR6HS	94702-00372-00
4A/5C/20C/25D/40X	NGKBR7HS	94701-00110-00
6C/8C/9,9D/9,9F/15D/15F/20D/25N/25V/25B/30D/40H/40V	NGKBR7HS-10	94702-00271-00
F8B	NGKCR5HSB	94701-00300-00
F9,9A/F9,9B	NGKCR6HS	94701-00282-00
F9,9C/FT9,9D/F15A/F25A/FT25B/F30A/F40A/F40B/F50A/FT50B/FT50C	NGKDP6EA-9	94701-00375-00
F15C/F20B/F25D/F25G/FT25F/F30B/F40F/F50F/F50H/FT50G/FT50J/F60C/F60F/FT60D/FT60G	NGKDP6EB-9	94702-00418-00
40Q	NGKBR8HS	94701-00195-00
30G/50D/50G/50H/55B/60F/70B/75A/75C/80A/85A/90A/100A/115A/115B/115C/140A/150A/150C/150F/175A/175B/175D/200A/200B/200F/200G/225D/(L)250A/(L)250G	NGKBR8HS-10	94702-00247-00
F60A/FT60B	NGKDP6EA-9	94701-00406-00
F70A	NGKLR7E	94702-00429-00
F80A/F80B/F100A/F100B/F100D/F(L)150A/F(L)200A/F(L)225A	NGKLR5A-11	94702-00391-00
130B/140B/200C/225B/250B/225G (VMAX)	NGKBR9HS-10	94701-00309-00
F(L)115B	NGKLR6E	94702-00437-00
F(L)115A/F175A/F(L)200C/F(L)200F/F(L)200G/F(L)225B/F225C/F(L)250A/F(L)250B/F(L)300A/F(L)350A/F(L)225F/F(L)250D/F(L)300B	NGKLR6A-11	94702-00400-00
(L)Z150P/Z150Q (VMAX)	NGKBKR6EKU	94702-00405-00
Z175G/(L)Z200N/Z200P (VMAX)/(L)Z250D/Z250F (VMAX)/(L)Z300A	NGKBKR7EKU	94702-00404-00
STERN-DRIVE ESSENCE	NGKBR6FS	94701-00365-00

**WAVERUNNER**

XL800/XLT800/GP800/WB800/GP800R	NGKBR8ES	94701-00204
XLT1200/XL1200LTD/GP1200R/GP1300R	NGKBR8ES-11	94702-00396
SJ650/650T/650TL/650TX/FX1/PRO TX700/WB700/XL700/WVT700/W.RAIDER 760/WVT760/XL760/WB760/GP760/W.RAIDER 1100/WVT1100/SUV1200/GP1200/XL1200	NGKBR8HS	94701-00195
SJ700/W.RAIDER 700	NGKBR7HS	94701-00110
FX140/FX140 CRUISER/FX160/FX160 CRUISER/FX1100 HO/HO CRUISER/VX 1100 SPORT & DELUXE	NGKCR9EB	94702-00409



# VOLANTE DE MOTOR

## FLYWHELL

## VOLANTE MOTORE

## VOLANT MOTEUR

### SIN DIENTES (MANUAL)

### WITHOUT TOOTH

### SENZA DENTI (MANUALE)

### MANUEL SANS DENT

REF	OEM
PAF20-05000500	6AH-85550-00

  
 F9.9H (2009+)
   
 F13.5B (2007-09)
   
 F15C,E,M (2007+)
   
 F20B, E, M (2007+)

REF	OEM
PAF15-07070000	66M-85550-00

  
 F9.9C, M (1998-08)
   
 FT9.9D (1999-08)
   
 F13.5A (2002-07)
   
 F15A,E,M (1998-07)

REF	OEM
PAF25-05150000	65W-85550-01

  
 F20/F25 (A) (1998-08)
   
 F40B/E/T (2000-09)
   
 FT/T25 (2000-09)
   
 F30A/E/M (2001-09)

### ELÉCTRICO

### ELECTRIC

### ELETTRICO

### ÉLECTRIQUE

REF	OEM
PAF20-05000500W	6AH-85550-10

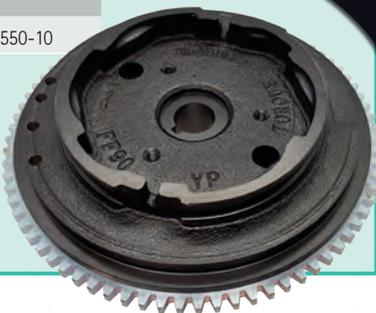
  
 F9.9H (2009+)
   
 F13.5B (2007-09)
   
 F15C,E,M (2007+)
   
 F20B, E, M (2007+)

REF	OEM
PAF15-07070100W	66M-85550-10

  
 F9.9C, M (1998-08)
   
 FT9.9D (1999-08)
   
 F13.5A (2002-07)
   
 F15A,E,M (1998-07)

# MOTORES DE ARRANQUE

# STARTERS

# MOTORINI AVVIAMENTO

# DEMARREUR

REF	OEM			2T STROKES	4T STROKES	
PH130-0061	6L2-81800-10, 11, 12 682-81800-10, 11, 12	12V 0.4 kw	10 CCW	✓		REC89-825096T01
	9.9-15HP (1984-97) 25HP (1988-98) 6HP (1984-90) 8HP (1984-90)					



REF	OEM			2T STROKES	4T STROKES	
PH130-0049	689-81800-10, 11, 12, 13	12V 0.6 kw	11 CCW	✓		REC89-825096T01
	25-40HP 30HP/20HP					



REF	OEM			2T STROKES	4T STROKES	
PH130-0062	6J4-81800-00, 01 6G8-81800-10, 11 6F5-81800-10, 11	12V	11 CCW	✓		REC89-825096T01
	30 HP (1987+) 40-50 HP (1989+)					



REF	OEM			2T STROKES	4T STROKES	
PH130-0084	66M-81800-00, 01, 02	12V	9 CCW	✓		REC89-825096T01
	F9.9, F15, F13.5 (1998-08)					



REF	OEM			2T STROKES	4T STROKES	
PH130-0005	6E5-81800-10, 11, 12	12V 1.1 kw	9 CCW	✓	✓	REC61A-81941-00
	F45 / F50 115-130 HP V4 150-175-200 HP V6					



REF	OEM			2T STROKES	4T STROKES	
PH130-0028	67C-81800-00, 01, 02	12V	9 CCW		✓	PH375-0036
	F30 (2000-09) F40 (2001-09)					



REF	OEM			2T STROKES	4T STROKES	
PH130-0063	6H4-81800-10, 11, 12	12V	9 CCW	✓		
	40-50 HP (1984-1988)					



REF	OEM			2T STROKES	4T STROKES	
PH130-0051	99999-03938 61H-81800-00, 01 6K7-81800-10 6N7-81800-00, 01, 10	12V 1.4 kw	9 CCW	✓		PH375-0047
	115-250HP V4					



REF	OEM			2T STROKES	4T STROKES	
PH130-0059	61A-81800-00, 01 69L-81800-00 69W-81800-00	12V	9 CCW	✓	✓	REC61A-81941-00 REC89-825096T01 (F40/50/60)
	V200 (1998+) F40 (2002-06) F50 (2003-14)	F60 (2003-07) 225 HWP (1994+) 250 HP (1990+)				





REF	OEM			2T STROKES	4T STROKES	
PH130-0050	6H3-81800-10, 11	12V 0.6 kw	9 CCW	✓		REC688-81950-10
	50HP (1993-14) 60HP (1991+) 70HP (1984-14)					



REF	OEM			2T STROKES	4T STROKES	
PH130-0007	99999-03249 697-81800-10, 11, 12 676-81800-10	12V 1.0 kw	9 CCW	✓		
	55-60HP 2 cyl					



REF	OEM			2T STROKES	4T STROKES	
PH130-0058	688-81800-10, 11, 12	12V	9 CCW	✓		REC688-81950-10
	75 HP (1994-99) 85 HP (1991-96) 90 HP (1984-14) 85HP (1992-03) 80HP (1993-02)					

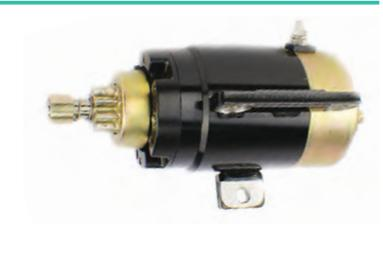

REF	OEM			2T STROKES	4T STROKES	
PH130-0056	6CJ-81800-00 6C5-81800-00 68F-81800-00, 01, 03	12V 1.4 kw	13 CCW	✓	✓	
	LZ 150-175 HP (2000+) VZ 150-175 HP (2000+) Z 150-175 HP (2000+) LZ 200-Z200 HP (2000+)					



REF	OEM			2T STROKES	4T STROKES	
PH130-0034	66M-81800-01, 02	12V	9 CCW		✓	PAF15-05170300W
	F9.9 F13.5 F15 HP (2000-08)					



REF	OEM			2T STROKES	4T STROKES	
PAF20-05000900W	6AH-81800-00, 01	12V	11		✓	
	F13,5 ALL (2007-09) F15 (2007-14) F20 ALL (2007-14)					

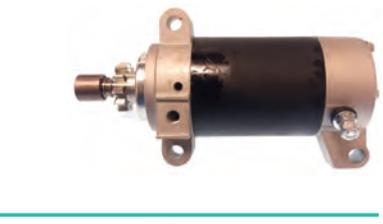

REF	OEM			2T STROKES	4T STROKES	
PH130-0029	65W-81800-00, 01, 02, 03	12V	9 CCW		✓	PH375-0034
	F20 F25HP (1999-09) F30/F40 (2005-09)					



REF	OEM			2T STROKES	4T STROKES	
PH130-0057	68V-81800-00, 01, 02	12V 1.4 kw	13 CCW		✓	
	F80 (2005+) F100 (2005+) F115 (2000+) LF115 (2000+)					



REF	OEM	⚡	☀️	2T STROKES	4T STROKES
PH130-0055	67F-81800-01, 02, 03, 04	12V 1.4 kw	13 CCW	✓	✓

F80 HP (1999+)  
F100 HP (1999+)



REF	OEM	⚡	☀️	2T STROKES	4T STROKES
PH130-0074	69J-81800-00, 01	12V 1.4 kw	13 CCW	✓	✓

F200, F225 HP (2002-2007)



REF	OEM	⚡	☀️	2T STROKES	4T STROKES
PH130-0073	63P-81800-00 6BR-81800-00, 01	12V 1.4 kw	13 CCW	✓	✓

FL, F150 AET, X, L (2009-11)  
FL, F200 CETX (2009-11)  
FL, F225 BET  
X, U, CET, L (2009-11)  
FL, F250 AET, X, U, BET, X, U (2009-11)



REF	OEM	⚡	☀️	2T STROKES	4T STROKES
PH130-0076	60V-81800-00 60X-81800-00 6C9-81800-00 6D0-81800-00	12V 1.4 kw	13 CCW	✓	✓

250HP (2003-07)



MUELLE DE ARRANQUE    STARTER SPRING    MOLLA AVVIAMENTO    RESSORT DE LANCEUR

REF	OEM	2T STROKES	4T STROKES
PAF15-07130107	63V-15713-00	✓	✓

6 - 25 hp



**new**

REF	OEM	2T STROKES	4T STROKES
REC66T-15713-00	66T-15713-00 6F5-15713-00, 01	✓	✓

25 - 40 hp



**new**

TRINQUETE TRACCIÓN    PAWL, DRIVE    CRICCHETO TRAZIONE    ENTRAÎNEMENT

REF	OEM	2T STROKES	4T STROKES
PAF15-07130202	63V-15741-00	✓	✓

6 - 40 hp



REF	OEM
PAF15-07130203	63V-15767-00
PAF15-07130204	63V-15784-00



PAF15-07130203    PAF15-07130204

**new**

CABLE DE MOTOR DE ARRANQUE A BATERÍA    CONNECTION LINE, POWER    CAVO MOTORE DI AVVIAMENTO A BATTERIA    CABLE DE CONNEXION

REF	OEM
PAT85-05000023	6C5-82105-01 6HO-82105-02, J2

-60 hp



**new**

**TIRADOR DE ARRANQUE**    **STARTER HANDLE ASSY**    **MANIGLIA AVVIAMENTO**    **POIGNEE DE LANCEUR**

REF	OEM
PAF4-04130100	6G1-15755-00 6G1-15779-00



new

**PLATO Y PLACA DE ARRANQUE MANUAL**    **PLATE & DRUM, DRIVE**    **PLACCA E PIATTO DI AVVIAMENTO MANUALE**    **TAMBOUR, POULIE**

REF	OEM	2T STROKES	4T STROKES
PAF15-07130201	63V-15714-00	✓	✓
PAF15-07130001	63V-15716-00	✓	✓



PAF15-07130201



PAF15-07130001

new

**LLAVES DE ARRANQUE**    **IGNITION STARTER SWITCH**    **CHIAVI DI ACCENSIONE**    **CONTACTEUR A CLÉ**

**MONTAJE EN MANDO DE CONTROL**    **CONTROL BOX**    **MONTAGGIO NEL TELECOMANDO**    **MONTAGE POUR BOITIER DE COMMANDE**

REF	OEM	2T STROKES	4T STROKES
PAF15-13000200W	703-82510-12	✓	✓



**MONTAJE EN PANEL**    **DASH MOUNT**    **MONTAGGIO NEL PANNELLO**    **MONTAGE POUR TABLEAU DE BORD**

REF	OEM	2T STROKES	4T STROKES
REC61B-82510-02	61B-82510-01	✓	



**LLAVE DOBLE INSTALACION**    **DUAL ENGINE APPLICATION**    **CHIAVE DOPPIA INSTALLAZIONE**    **POUR INSTALLATION DOUBLE**

REF	OEM	2T STROKES	4T STROKES
REC6K1-82510-07	6K1-82510-06	✓	✓



LLAVE CON CHOQUE

PUSH T. CHOKE

CHIAVE CON CONTATTO

AVEC STARTER

REF	OEM	2T STROKES	4T STROKES
REC703-82510-44	703-82510-43	✓	✓



LLAVE PARA MANDO POPERO

KEY FOR STERN CONTROL

CHIAVE PER COMANDO A GUIDA

CONTACTEUR A CLE COMPLET

new

REF	OEM	2T STROKES	4T STROKES
REC6H3-82510-03	6H3-82510-00, 01, 02, 03	✓	✓

- 55B (1992-00)
- E60H (1996-97)
- 75A (1992-95)
- 85A (1995)



SOLENOIDE RELE

SOLENOID RELAY

SOLENOIDE RELE

SOLENOIDE RELAIS

REF	OEM
PH375-0034	65W-81941-00

- F20 (1998-09)
- F25 (1998-09)
- F30 (2001-09)
- F40 (2000-09)



REF	OEM
REC688-81950-10	688-81950-10

- 50G 80A
- 50D 90A
- E60 60F
- 70B



REF	OEM
REC61A-81941-00	61A-81941-00 6E5-81941-11

- 150 175
- 200 115
- 225 130
- 250 100HP



REF	OEM
REC89-825096T01	6E5-81950-01 6G1-81940-00

- 6 - 90 HP



new

REF	OEM
PH375-0042	68V-8194A-00 68N-81940-00

- F40 - F200 (2000-16)
- Z / LZ / VZ200 (2004-07)
- Z / LZ / VZ250 (2003-07)
- Z / LZ / VZ300 (2004-07)



REF	OEM
PAF15-05170300W	6G1-81941-10

- 6 - 90 HP



new

REF	OEM
REC61A-81950-01	61A-81950-00, 01

50 -250 hp (1990-16) 2 Strokes  
F20, F25 (1998-09) 4 Strokes



REF	OEM
REC68V-81950-00	68V-81950-00

20 - 300 HP



REF	OEM
REC6AW-8194A-00	6AW-8194A-00

F30 / F40 (2009+)  
F300 (2008-11)  
F350 (2008+)



REF	OEM
REC60E-81950-00	60E-81950-00

30 - 115 HP



REF	OEM
REC63P-81950-00	63P-81950-00

F20 - F300



REF	OEM
REC6AW-81950-00	6AW-81950-00

F150C/G (2017+)  
F1475C (2017+)  
F200C/G (2013+)  
F225C/F (2011+)  
F250B/D/C (2009+)  
F300A/B/C (2008+)  
F350A/C/T (2008+)



REF	OEM	12V
REC60V-81950-00	60V-81950-00	12V

Z250D,T,F (2003-07)  
Z300A,T (2004-07)



REF	OEM	2T STROKES	4T STROKES
REC6H1-81950-01	6H1-81950-00, 01	✓	✓

30 / 40 / 45 / 50 / 60 HP (1995+)



REF	OEM
PH375-0048	6E5-8195A-01 6E5-8195C-01

100 (1996-01)  
115 (1991-13)  
130 (1991-07)  
150 (1998-07)  
175 (1996-03)  
200 (1991-10)  
225 (1996-09)  
F100 A/AET/TLR/TRZ (1999-06)  
F100 BET (2003-12)  
F100 CETL (2003)  
40X/E40MLH (1998-03)  
F80A/AET/TLR (1999-06)



REF	OEM
PH375-0047	6E5-81950-01

175HP (1991-96)  
200HP (1991-10)  
225HP (1996-09)  
150HP (1996-03)  
115HP (1995-13)  
100HP (1996-01)  
130HP (1991-07)



REF	OEM	2T STROKES	4T STROKES
REC68F-8195A-00	68F-8195A-00	✓	✓

150 --> 350 HP



## REGULADORES Y RECTIFICADORES

## REGULATOR AND RECTIFIERS

## REGOLATORI E RADDRIZZATORI

## REGULATEURS ET RECTIFIEURS

REF	OEM	2T STROKES	4T STROKES
REC6H2-81960-10	6H2-81960-10	✓	

 40  
 50  
 60  
 70

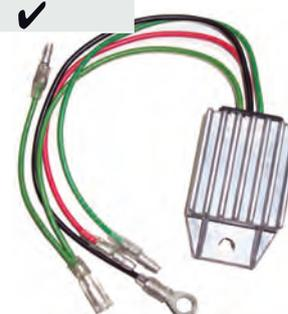

REF	OEM	2T STROKES	4T STROKES
REC6G1-81970-62	664-81970-60, 61, 62 676-81970-00 6E9-81970-70 6G1-81970-00, 60, 61, 62, A0	✓	

 4 Et 5 HP (1 cyl)  
 6, 8, 9.9, 15, 20, 25, 30, 40 (2 cyl)  
 40, 50, 55, 60, 70 (3 cyl)



REF	OEM	2T STROKES	4T STROKES
REC67F-81960-12	67F-81960-00	✓	

 F75AETL (2003)  
 F80A,TLR,TJRA (1999-06)  
 F90AET,TRB,TLRB (2003)  
 F100A,TLR,BET,CET (1999-12)



REF	OEM	2T STROKES	4T STROKES
REC6H0-81960-00	6H0-81960-00	✓	

 75A, AEM, AEHD  
 85A, AE, AED, AEDL, AEDH, AEDX, AET, AETL, AETX  
 E115 A, AE, AEL, AMH, AMHL, AET, AETL, AETX

693-6922 (1997-02)  
 688-688F (1997-15)  
 61U0-61UG (2001-15)



REF	OEM	2T STROKES	4T STROKES
REC6G5-81960-A0	6G5-81960-A0	✓	

 75 (1988-96)  
 85 (1989-96)  
 90 (1984-91)  
 115 (1991-96)  
 130 (1988-89)  
 150 (1984-89)  
 150 (1997)  
 175 (1984-89)  
 200 (1984-89)

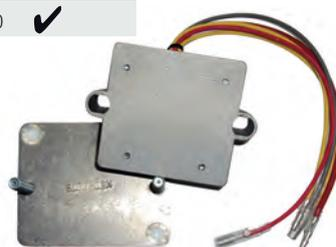

REF	OEM	2T STROKES	4T STROKES
REC6R3-81960-10	6R3-81960-10	✓	

 100A (1991)  
 115C (1990-13)  
 130B/T (1990-14)  
 150C/F/T (1990-13)  
 175B/D (1990-05)  
 200B/C (1991-93)  
 PROV200 (1991-94)  
 225B (1990-91)

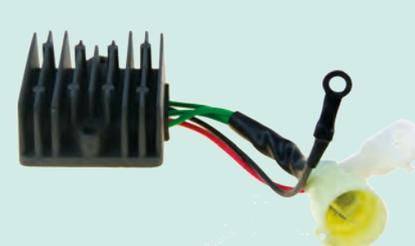

REF	OEM	2T STROKES	4T STROKES
PAT85-05030300	6AH-81960-00	✓	

 F9.9H (2009+)  
 F13.5B (2007-09)  
 F15C/E/M (2007+)  
 F20B/M (2007+)



REF	OEM	2T STROKES	4T STROKES
REC6P2-81960-03	6P2-81960-02,03	✓	

 F200A/C (2006-15)  
 F225A/B/C (2007-15)  
 F250A/B/T (2006-13)

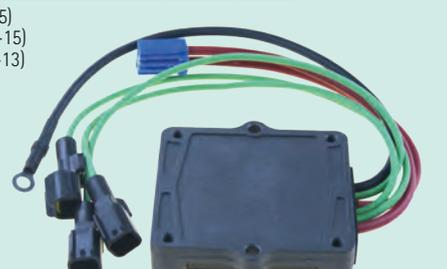

REF	OEM	2T STROKES	4T STROKES
REC63P-81960-02	63P-81960-00, 01, 02	✓	

 F150A,T,B,D,F (2004+)



REF	OEM	2T STROKES	4T STROKES
REC61A-81960-04	61A-81960-00, 01, 02, 03, 04	✓	

 225C/G (1994-03)  
 250A/B/E/G (1990-10)



REF	OEM	2T STROKES	4T STROKES
REC6G8-81960-A1	6G8-81960-A1		✓

 F8B (1990-99)  
 FT9.9D (1999-08)  
 F9.9C/A/B/M (1990-08)  
 F13.5A (2005-07)  
 F15A/M/E/P (1998-07)

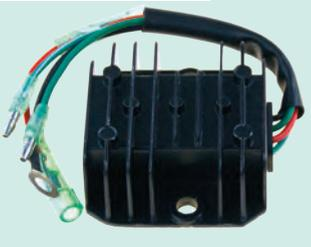

REF	OEM	2T STROKES	4T STROKES
PAF15-07060001	6J8-81960-00	✓	✓

 6 - 50 HP

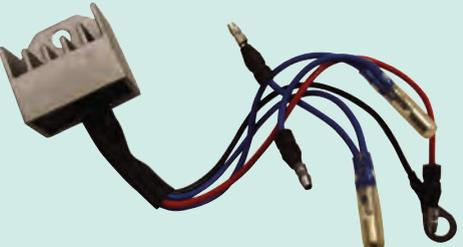

REF	OEM	2T STROKES	4T STROKES
REC881346T	68V-81960-00 6D3-81960-00		✓

 T/FT/F50 (2005-06)  
 T/FT/F60C/D/T (2005-06)  
 F75B/T (2005)  
 F80B (2005-06)  
 F100D (2005-06)  
 F115A/T (2000-06)



REF	OEM	2T STROKES	4T STROKES
REC69J-81960-13	69J-81960-10, 11, 12, 13		✓

 F200A/T (2003-07)  
 F225A/T (2003-07)



REF	OEM	2T STROKES	4T STROKES
REC60V-81960-05	60V-81960-00, 01, 02, 03, 04, 05	✓	

 250D/F/T (2003-07)  
 300A/T (2004-07)

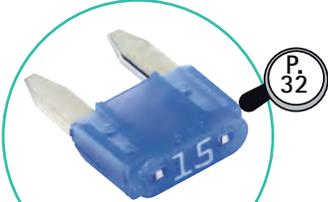
**CDI Y CAJAS NEGRAS    CDI & POWER PACK    CDI E CENTRALINA    CDI ET BOITIER ELECTRONIQUE**

REF	OEM	2T STROKES	4T STROKES
REC688-85540-00	688-85540-00	✓	

 E75 BMHD, BMHDL  
 75 A, AED, AEDL, AEM, AEHD, AET, AETL  
 75A  
 85, A, AE, AED, AEDL, AEDX, AEHD, AET, AETX  
 85A

6925 - 692Y (2003-15)  
 692 - 692Y (1997-15)  
 692E (2008)  
 688 - 688F (1997-15)  
 6886 - 6887 (2007-08)



REF	OEM	2T STROKES	4T STROKES
REC6G9-85540-29	6G9-85540-29 6G9-85540-22 6G9-85540-21 6G9-85540-20		✓

 F8B (1985-99)  
 F9.9B (1985-99)  
 2 CYL.



REF	OEM	2T STROKES	4T STROKES
PAF20-05000300	6AH-85540-00		✓

 F9.9H (2009+)  
 F13.5 B (2008-09)  
 F15C/E/M (2007+)  
 F20B/E/M (2007+)



REF	OEM	2T STROKES	4T STROKES
REC63D-85540-04	63D-85540-00, 01, 02, 03, 04		✓

 3 cyl  
 C40 (1996-03)  
 40V,E,Y (1995+) C50 (2000)  
 50H (1995-03)



REF	OEM	2T STROKES	4T STROKES
PAF15-07000500	66M-85540-10		✓

 F9.9C, M (2002-07)  
 F13.5 A (2002-07)  
 F155A,E,M,P (2002-07)



REF	OEM	2T STROKES	4T STROKES
REC6F6-85540-01	6F6-85540-01		✓

 E40G (2008-16)



REF	OEM	2T STROKES	4T STROKES
REC6H3-85540-11	6H3-85540-10, 11, 12		✓

 3 cyl (1984+)  
 60F/E60H,E,M  
 70E,B

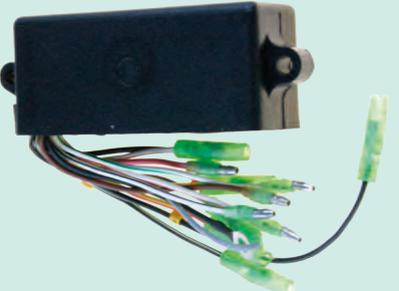

REF	OEM	2T STROKES	4T STROKES
REC6H3-85540-13	6H3-85540-10, 11, 12, 13		✓

 60F (1984-91)  
 70B,E (1984-91)  
 E60H,E (2000+)



REF	OEM	2T STROKES	4T STROKES
REC63V-85540-00-01	63V-85540-00, 01, 02		✓

 9.9 - 15HP (1995+)  
 63V & 63W



REF	OEM	2T STROKES	4T STROKES
REC6H2-85540-13	6H2-85540-10, 11, 12, 13		✓

 50G (1997-07)  
 60F,T (1997-10)  
 70B,T (1997-17)



REF	OEM	2T STROKES	4T STROKES
REC68T-85540-00	68T-85540-00		✓

 F6A/B/M (2001-05)  
 T/FT/F8C/M (2000+)  
 T/FT/F9.9F/M/J (2008+)



REF	OEM	2T STROKES	4T STROKES
REC6A1-85540-01	6A1-85540-00, 01		✓

 2B,M,C (1995-10)



REF	OEM	2T STROKES	4T STROKES
REC6G9-85540-29	6G9-85540-20, 21, 22, 29		✓

 F8B (1985-99)  
 F9.9B, M, E (1985-06)





REF	OEM	2T STROKES	4T STROKES
REC63V-85540-00-01	63V-85540-00,01	✓	
	9.9, 15HP (1995-08) 13, 5HP (2003-04)		



REF	OEM	2T STROKES	4T STROKES
REC6F5-85540-22	6F5-85540-22	✓	
	E40 (2003)		



REF	OEM	2T STROKES	4T STROKES
REC61N-85540-00	61N-85540-00	✓	
	25 (1997-07) 30 (1996-08) 200 (1993)		



REF	OEM	2T STROKES	4T STROKES
REC695-85540-11	695-85540-11,12	✓	
	E40 (2003) 9.9 (1986-95) 15 (1986-95) 20 (1985-02) 25 (1985-02)		



REF	OEM	2T STROKES	4T STROKES
REC6G0-85540-11	6G0-85540-11	✓	
	175 (1986-89) 200 (1986-89) 150 (1988) 225 (1987-89)		



REF	OEM	2T STROKES	4T STROKES
REC663-85540-15	663-85540-11,15	✓	
	55 (1990-93)		



REF	OEM	2T STROKES	4T STROKES
REC6E0-85540-71	6E0-85540-71,70	✓	
	4 (1984) 5 (1984)		



REF	OEM	2T STROKES	4T STROKES
REC6E5-85540-12	6E5-85540-12,11,10	✓	
	115 (1984-89) 115 (1991-98) 130 (1988-89)		



REF	OEM	2T STROKES	4T STROKES
REC689-85540-21	689-85540-21,20	✓	
	25 (1984-87) 30 (1984-87) 30 (1989-90) 40 (1990)		



REF	OEM	2T STROKES	4T STROKES
REC6G5-85540-12	6G5-85540-12,11,10	✓	
	150HP (1984-89)		



REF	OEM	2T STROKES	4T STROKES
REC696-85540-12	696-85540-12,11,10	✓	
	6 (1984-99) 8 (1984-04)		



REF	OEM	2T STROKES	4T STROKES
REC66T-85540-00-01	66T-85540-01	✓	
	40X/E40X MLH XW (1998+)		



REF	OEM	2T STROKES	4T STROKES
REC6B4-85540-01	6B4-85540-01	✓	

 E9.9 DMH-5 (2003+)  
 E15 DMH -5 (2003+)



REF	OEM	2T STROKES	4T STROKES
REC688-85540-16	688-85540-16	✓	

 75  
 85

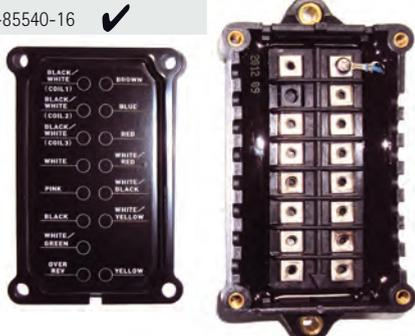

REF	OEM	2T STROKES	4T STROKES
REC6J8-85540-H2	6J8-85540-H2	✓	

 25J/EO/SH (1999)  
 30D/ETOL/EOS/MHS  
 MHOL, E, L, H  
 (1999+)



**DESCONECTORES DE SEGURIDAD    CUT OFF SWITCHES    CHIAVETTA DI SICUREZZA    COUPE CIRCUIT DE SECURITE**

REF	OEM
REC688-82575-01	688-82575-01

 9.9 --> 250 HP



REF	OEM
REC6E9-82575-02	6E9-82575-00

 E30/GE/BMH (1996-12)  
 25V/M/E/B (1996-10)  
 6/8C/TRV/MSH (1996-12)



REF	OEM
REC69W-82575-00	69W-82575-00



REF	OEM
PAF4-01090401	682-82556-00

**new**



REF	OEM
REC66T-82575-01	66T-82575-01

 E40X  
 MLHZ  
 X  
 MH (2001+)



REF	OEM
REC65W-82575-01	65W-82575-01

 F2.5  
 T-F 6-8  
 F9.9 -F15  
 9.9F-M  
 F13.5  
 F25 (2002+)



REF	OEM
REC6G8-81870-00	6G8-81870-00

 F8A-B (1986-99)  
 F9.9A M,E,B (1985-99)  
 9.9F (1995-2000)  
 9.9-15-8-6/C-M-D (1984-2002)



REF	OEM
REC6A0-82550-01	6A0-82550-01

 9.9D/15D (1985-93)  
 8N/JCEM (1984-96)  
 6CEM/6DEM (1984-96)



### KITS

Interruptor de encendido para todo tipo de motores fueraborda o intraborda

REF KIT	CUERDA WIRE CORDA CORDON	
REC40970	REC40990	1

### KITS

Emergency and stop switch for inboard or outboards.



### KIT

Interruttore di accensione per tutti i tipi di motori fuoribordo o entro bordo.

REF KIT	CUERDA WIRE CORDA CORDON	
GS11290	GS11291	1



### KITS

Coupe circuit de sécurité pour moteur inboard ou hors-bord

REF KIT	
GS11292	1



REF	
GS11294	1



## STARTOR

REF	OEM	2T STROKES	4T STROKES
REC688-85510-10	688-85510-10 688-85510-11	✓	



75 (1988-96)  
85 (1989-96)  
90 (1984-90)



REF	OEM	2T STROKES	4T STROKES
REC6E5-85510-11	6E5-85510-11,10	✓	



115 (1984-89), (1991-98)  
130 (1988-89)  
150 (1984-89)



REF	OEM	2T STROKES	4T STROKES
REC688-85510-01	688-85510-00, 01	✓	



E75 BMHD, BMHDL (6925 - 692Y) (2003-15)  
75 A, AED, AEDL, AEM, AEHD, AET, AETL (692 - 692Y) (1997-15)  
75 A (692E) (2008)  
85 A, AE, AED, AEDL, AEDX, AEHD, AET, AETX (688 - 688F) (1997-15)  
85 A (6886 - 6887) (2007-08)



REF	OEM	2T STROKES	4T STROKES
PAF25-05140000	65W-85510-10	✓	



F20 (1998-06)  
F25 (1998-09)  
T25/FT25 (2000-09)  
F30 (2001-09)  
F40 (2000-09)



REF	OEM	2T STROKES	4T STROKES
REC6G5-85510-11	6G5-85510-10	✓	



200 (1984-89)



REF	OEM	2T STROKES	4T STROKES
REC6H1-85510-00	6H1-85510-00	✓	



80A AE (1990-91)  
90 AEO AETO (1990-91)

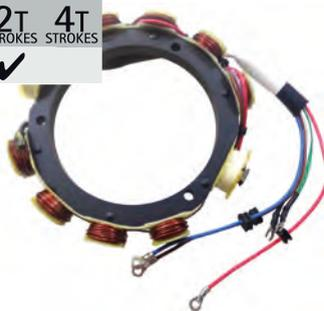

REF	OEM	2T STROKES	4T STROKES
PAF20-05000200	6AH-85510-00	✓	



F9,9 (2009+)  
F13,5B (2007-09)  
F15C,E,M (2007+)  
F20B,M (2007+)



new

# TRIM, TILT & POWER TRIM

## INSTALACIÓN ELÉCTRICA

## WIRING HARNESS

## INSTALLAZIONE ELETTRICA

## INSTALLATION ELECTRIQUE

### KIT CONVERSIÓN

Sustituye de 2 a 3 cables.

### CONVERSION KIT

Converts 3-wire Tilt and Trim motors to 2-Wire design

### KIT CONVERSIONE

Sustituisce da 2 a 3 cavi.

FAISCEAU CONVERTISSEUR 3 A 2 FILS

REF	OEM
PH200-WH01	



## INTERRUPTOR POWER TRIM POWER TRIM SWITCH

REF	OEM
REC6R3-82563-01	6R3-82563-00 6R3-82563-01

100 - 250 HP

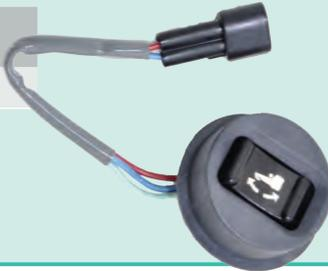

## INTERRUTTORE POWER TRIM

REF	OEM
PAE4-10040100W	703-82563-00, 01

Para mandos 703  
For controls 703  
Per comandi 703  
Pour 703

## INTERRUPTEUR DE TRIM

new



## TRIM COMPLETO BIDIRECCIONAL

## COMPLETE TRIM ASSEMBLY

## MOTORINO TRIM COMPLETO

## MOTEUR DE TRIM

REF	OEM	⚡	⚙️	⚙️	2T STROKES	4T STROKES
REC67C-43880-01	67C-43880-00, 01	12V	4	2		✓

T25 / FT25 (68V0 - 68V9) (2001-09)  
T25 / FT25 (6BL1 - 6BL8) (2009-15)  
F30 (69H1 - 69H9) (2001-09)  
F30 (6BT1 - 6BT8) (2009-15)  
F40 (67C0 - 67C8) (2001-09)  
F40 (6BG1 - 6BG8) (2009-15)



REF	OEM	⚡	⚙️	⚙️	2T STROKES	4T STROKES
PH200-T048	6H5-43880-00, 01, 02, 09	12V	4	2		✓

40-50HP (1984-94)



REF	OEM	⚡	⚙️	⚙️	2T STROKES	4T STROKES
PH200-T029	6H1-43880-02	12V	3	2	✓	

40HP (1994)  
50-90HP (1992-95)  
70-90 (1996)  
60-70-90 (1998)  
90HP (1992-02)



REF	OEM	⚡	⚙️	⚙️	2T STROKES	4T STROKES
PH200-T036	62Y-43880-01, 02 69W-43880-00, 01 CS3-43880-00	12V	3	2	✓	✓

40Y (2005-07)  
40V (2003)  
C40 (2002)  
F40 (2002)  
F50 (2002-07)  
FT50



REF	OEM	⚡	⚙️	⚙️	2T STROKES	4T STROKES
PH200-T035	62X-43880-00, 01, 09	12V	3	2	✓	✓

40V (1995-98)  
F45 (1995-99)  
50H (1995-98)  
F50 (1995-99)  
FT50 (1996-00)



REF	OEM	⚡	⚙️	⚙️	2T STROKES	4T STROKES
PH200-T041	6H1-43880-00	12V	3	2	✓	

60F (1987-91)  
70B (1987-91)  
75A (1990-91)  
80A (1987-91)  
85A (1990-91)  
90A (1987-91)



+ relés conversión | relay | rele | relais

REF	OEM	⚡	🔩	🔧	2T STROKES	4T STROKES
PH200-T044	67F-43880-00	12V	4	2		✓

F75 (2003-04)  
 F80 (1999-05)  
 F90 (2003-04)  
 F100 (1999-05)



REF	OEM	⚡	🔩	🔧	2T STROKES	4T STROKES
PAT40-10020500	65W-43880-00, 01		4	2		✓

F20AE, AET, DET (1998-15)  
 F25A, AET, AMH, AW, EH, ELH, MHA, DMH, DET (1998-15)  
 F45AET/F50TJR (1999)  
 25J, JEO, ESH (1999)  
 30D, DETO, DMH (1999-10)  
 40X/E40X (1998-03)



REF	OEM	⚡	🔩	🔧	2T STROKES	4T STROKES
PH200-T068	6D8-43880-00, 01, 09	12V	4	2		✓

F75  
 F80  
 F100

EJE CORTO  
 SHORT SHAFT  
 ASSE CORTO  
 AXE COURT



REF	OEM	⚡	🔩	🔧	2T STROKES	4T STROKES
REC6D8-43880-09	6D8-43880-00, 09	12V	4	2		✓

F75TR, TLR, BET (2005)  
 F80AET, BET (2005-06)  
 F100AET, DET (2005-06)

EJE LARGO  
 LONG SHAFT  
 ASSE LUNGO  
 AXE LONG



REF	OEM	⚡	🔩	🔧	2T STROKES	4T STROKES
PH200-T069	69J-43880-00, 01 60V-43880-00		3	2		

F200  
 F225 (2002+)  
 F250 (2005+)  
 Z300



REF	OEM	⚡	🔩	🔧	2T STROKES	4T STROKES
REC6AW-43880-02	6AW-43880-00, 01, 02	12V	2	2		✓

F300A (2008-11)  
 F350A (2008+)

**new**



REF	OEM	⚡	🔩	🔧	∅	2T STROKES	4T STROKES
PH200-T037	688-43880-11 6E5-43880-00, 01, 02	12V	3	3	68,3 mm	✓	

60 90  
 70 115  
 75 150  
 80 200HP  
 85

 4 mm



REF	OEM	⚡	🔩	🔧	2T STROKES	4T STROKES
PH200-T030	6G5-43880-00, 01, 02	12V	3	2		✓

115-200 (1987-95)  
 225 (1990-94)



REF	OEM	⚡	🔩	🔧	2T STROKES	4T STROKES
PH200-T057	6AE-43880-00, 01, 03, 04 68W-43880-03 67H-43880-00	12V	4	2		✓

225  
 250HP  
 115  
 225 (1997-02)



REF	OEM	⚡	🔩	🔧	2T STROKES	4T STROKES
PH200-T045	6C5-43880-00, 01		3	1		✓

F40 (2006-10)  
 F60 (2006-10)  
 F50 (2005-10)  
 FT60 (2006-10)  
 40-50HP (1985-92)



REF	OEM	⚡	🔩	✂️	2T STROKES	4T STROKES
PH200-T050	61A-43880-00, 01	12V	3	4	✓	



225  
250HP

REF	OEM	⚡	🔩	✂️	2T STROKES	4T STROKES
REC63P-43880-22	63P-43880-10 63P-43880-11 63P-43880-12 63P-43880-22	12V	3	2		✓



F150A/B/C/D/F/G (2012+)  
F175A,C (2018+)  
F200B,C,F,G (2018+)

**POWER TRIM COMPLETO**      **COMPLETE POWER TRIM ASSEMBLY**

REF	OEM	2T STROKES	4T STROKES
REC18-6865	63P-43880-03-00 64E-43880-02-40 68V-43880-03-40	✓	✓



3 RAM  
115-225HP  
SHOWA SYSTEM

**MOTORINO POWER TRIM COMPLETO**      **POWER TRIM COMPLET**

REF	OEM	2T STROKES	4T STROKES
PAT40-10000000	65W-43800-02-4D 65W-43800-03-4D 65W-43800-21-4D 65W-43800-22-8D 65W-43800-23-8D 65W-43800-20-4D 65W-43800-01-4D 65W-43800-00-4D	✓	✓



F20 / F25  
E40 / 40X  
30D

REF	OEM	2T STROKES	4T STROKES
REC63P-43800-20	63P-4380003, 04, 06, 07, 20 64E-43880-02-40 68V-43880-03-40	✓	✓



115-220 HP (2003+)  
SHOWA SYSTEM

REF	OEM	2T STROKES	4T STROKES
PAF60-06000000	6C5-43800-11, 12		✓



F40/ F50/ F60 (2016+)

REF	OEM	2T STROKES	4T STROKES
REC6H1-43800-17-8D	6H1-43800-17-8D 6H1-43800-16-4D 6H1-43800-15-4D 6H1-43800-13-4D 6H1-43800-14-4D	✓	



50 - 90 HP

DESPIECE PISTÓN TRIM	PARTI PISTONE TRIM	PARTI PISTONE TRIM	PIECES VERIN DE TRIM
REF	OEM		UN.
REC64E-43821-05	64E-43821-00, -05 64E4382100, 64E4382105	TORNILLO CILINDRO EXTREMO	SCREW VITE VIS 2
REC48630-96J03	64E-43821-08, 09, 00 64E-43820-08, 09, 00 6AW-4380R-00	TAPÓN PARA SHOWA SYSTEM	CAP FOR SHOWA SYSTEM TAPPO PER SHOWA SYSTEM NEZ DE VERIN DE TRIM POUR SHOWA SYSTEM 2
1 REC48630-94900	67F-4380R-01, -00 67F-43811-00 61A-43821-00, -01, -09	TORNILLO CILINDRO EXTREMO	SCREW VITE VIS 2
REC48630-92J00	6EK-4380R-00 64E-43821-05 63P-43811-20, -10 64E-43811-02 61A-43811-00 6AW-4380R-01	TAPÓN PARA SHOWA SYSTEM	CAP FOR SHOWA SYSTEM TAPPO PER SHOWA SYSTEM NEZ DE VERIN DE TRIM POUR SHOWA SYSTEM 2
2 REC64E-43822-00	64E-43822-00	SELLO	SEAL OIL PARAOLIO JOINT TORIQUE 2
3 REC64E-4384J-00	64E-4384J-00	SELLO	SEAL OIL PARAOLIO JOINT TORIQUE 2
4 REC6G5-43864-00	6G5-43864-00	SELLO	SEAL OIL PARAOLIO JOINT TORIQUE 2

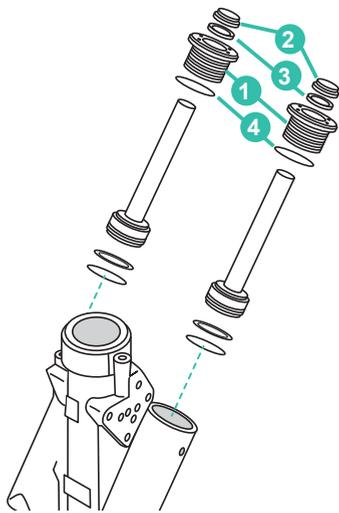

REF	OEM
REC48630-94900	67F-4380R-01, -00 67F-43811-00 61A-43821-00, -01, -09

F75B/T (2005)  
F80A/B/T (1999-18)  
F100A/C/D (1999-18)  
F200, F225, F250 (2002-12)  
Z200, Z300 (2003-12)  
250G (2006-10)  
F300 (2011-12)

REF	OEM
REC48630-92J00	6EK-4380R-00 64E-43821-05 63P-43811-20, -10 64E-43811-02 61A-43811-00 6AW-4380R-01

REF	OEM
REC64E-43821-05	64E-43821-00 64E-43821-05 64E4382100 64E4382105

REF	OEM
REC48630-96J03	64E-43821-08, 09, 00 64E-43820-08, 09, 00 6AW-4380R-00

100 - 300 HP  
F300, F350 (V8) (2008-12)

EXTRACTOR TAPONES DE TRIM	TRIM PLUGS EXTRACTOR	ESTRATTORE PER TAPPI DI TRIM	KIT EXTRACTEUR
REF		TRIM PISTON	TILT PISTON
RECTOOLTRIMKIT	RECTOOLTRIM1 + RECTOOLTRIM2 + RECTOOLTRIM3	RECTOOLTRIM1	F25 - F40
		RECTOOLTRIM2	RECTOOLTRIM3 F115 (2000-14)
		RECTOOLTRIM2	RECTOOLTRIM3 F150 (2004-10)
		RECTOOLTRIM2	RECTOOLTRIM1 F150 (2011+)
		RECTOOLTRIM2	RECTOOLTRIM3 F175 - F200 (2.8L)
		RECTOOLTRIM1	RECTOOLTRIM1 F200 - F250 (3.3L)
		RECTOOLTRIM1	RECTOOLTRIM1 F225 - F300 (4.2L)
		RECTOOLTRIM2	RECTOOLTRIM3 F350
		RECTOOLTRIM2	F425
		RECTOOLTRIM2	55-90 (2-Stroke) (1994+)
		RECTOOLTRIM2	RECTOOLTRIM3 115-200 + VMAX
		RECTOOLTRIM1	RECTOOLTRIM1 225 (2-Stroke)

**KITS DE RECAMBIO**  
Los pines de repuesto no tienen garantía.

REF	
RECPIN4	3 PIN x 4 mm
RECPIN4.5	3 PIN x 4.5 mm
RECPIN6	3 PIN x 6 mm

**SPARE KITS**  
Replacement pins are not guaranteed.

**KIT DI RICAMBIO**  
I perni di ricambio non sono garantiti.

**KIT DE RECHANGE**  
Les pins de remplacement ne sont pas garanties

# SISTEMA DE GOBIERNO STEERING SYSTEM

# SISTEMA DI GUIDA SYSTÈME DE DIRECTION

## MANDOS DE CONTROL

## ENGINE CONTROLS

## COMANDI DI CONTROLLO

## BOITIER DE COMMANDE

### MANDO LATERAL (703) PUSH TO OPEN

### SIDE CONTROL (703) PUSH TO OPEN

### COMANDO LATERALE (703) PUSH TO OPEN

### BOITIER LATERAL (703) PUSH TO OPEN

Conector de 7 pins. Sin PowerTrim  
Para motores fueraborda Yamaha de 9,9  
Electric a 30 Hp. Leva para aceleración en  
punto muerto. Utiliza cables 33-C

Connector 7 pins. Without PowerTrim  
For outboard engines Yamaha 9,9 Electric to  
30 Hp. Lever for neutral engine warm-up.  
For 33-C cables

Conettore da 7 pins. Sin PowerTrim  
Per motori fuoribordo Yamaha da 9,9  
Electric a 30 Hp. Leva per accelerare in un  
punto morto. Utilizza cavi 33-C.

Connecteur 7 broches. Sans Trim. Pour  
moteur hors-bord Yamaha de 9.9  
électrique à 30cv. Utilise des câbles 33C.

REF	OEM	2T STROKES	4T STROKES
	703-48230-10		
	703-48230-11		
	703-48230-12		
	703-48230-13		
	703-48230-14		
REC703-48230-14	703-48230-15	✓	✓
PAF15-13000000W	703-48230-16		
	703-48230-17		
	703-48230-18		
	703-48230-1A		
	703-48230-20		
	703-48230-21		



Conector de 10 pins. Con PowerTrim  
Para motores fueraborda Yamaha de 40  
a 250 Hp. Leva para aceleración en punto  
muerto. Con interruptor y cableado de  
Power Trim. Utiliza cables 33-C

Connector 10 pins. With PowerTrim  
Dual function, single lever control, For  
outboard Yamaha 40 to 250 Hp. With power  
trim switch and wires. For 33-C cables.

Conettore da 10 pins. Con PowerTrim  
Per motori fuoribordo Yamaha da 40 a 250  
Hp. Leva per accelerare in un punto morto.  
Con interruttore e cablaggio di Power Trim.  
Utilizza cavi 33-C.

Connecteur 10 broches. Avec Trim  
interrupteur et faisceau. Boitier pour  
moteur hors-bord Yamaha de 40 à 250cv.  
Lever pour se mettre au point mort. Utilise  
des câbles 33C.

REF	OEM	2T STROKES	4T STROKES
	703-48205-10		
	703-48205-11		
	703-48205-12		
	703-48205-13		
	703-48205-14		
REC703-48205-16	703-48205-15	✓	✓
PAT85-08010000W	703-48205-16		
	703-48205-17		
	703-48205-18		
	703-48205-1A		
	703-48205-1B		
	703-48205-20		
	703-48205-21		



### MANDO LATERAL PULL TO OPEN

### SIDE CONTROL PULL TO OPEN

### COMANDO LATERALE PULL TO OPEN

### BOITIER LATERAL PULL TO OPEN

REF  
PAF40-13000000E1



new



**PUSH TO OPEN**

REF	OEM
PAF15-13000500W	703-48261-01



*new*

**PULL TO OPEN**

REF	OEM
PAT20-13000500W	703-48861-11

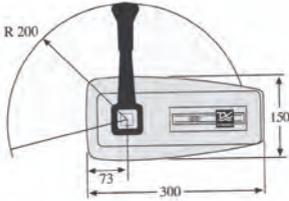

*new*

MANDO LATERAL	SIDE CONTROL	COMANDO LATERALE	BOITIER LATERAL				
<p>Mando a distancia de palanca con doble función (acelerador y cambio). Para motores intraborda e intra-fueraborda. Montaje lateral superpuesto. Utiliza cables 33-C.</p> <table border="1"> <thead> <tr> <th>REF</th> <th>OEM</th> </tr> </thead> <tbody> <tr> <td>GS40015</td> <td>YMD-RCBOX-00-10</td> </tr> </tbody> </table> <p><b>GOLDENSHIP</b></p> 	REF	OEM	GS40015	YMD-RCBOX-00-10	<p>Dual function, single lever control, For virtually all stern drive, outboard and inboard engines. Push button for neutral engine warm-up. For 33-C cables.</p>	<p>Comando a distanza di leve con doppia funzione acceleratore e cambio. Per motori entroborde e entro-fuoribordo. Montaggio laterale sovrapposto. Utilizza cavi 33-C.</p> 	<p>Boitier mono levier bi-fonction accélérateur et inverseur pour moteur inboard et hors-bord. Bouton poussoir pour se mettre au point mort. Utilise des câbles 33C.</p>
REF	OEM						
GS40015	YMD-RCBOX-00-10						

MANDO PARA CONSOLA	CONSOLE CONTROL	COMANDO PER CONSOLLA	BOITIER POUR CONSOLE																																												
<table border="1"> <thead> <tr> <th>REF</th> <th>YAMAHA 704</th> <th>TRIM</th> </tr> </thead> <tbody> <tr> <td rowspan="11">REC704-48205-RO</td> <td>704-48205-RO</td> <td></td> </tr> <tr> <td>704-48205-P1</td> <td></td> </tr> <tr> <td>704-48205-B1</td> <td></td> </tr> <tr> <td>704-48205-B0</td> <td></td> </tr> <tr> <td>704-48205-RO</td> <td></td> </tr> <tr> <td>704-48205-14</td> <td>✓</td> </tr> <tr> <td>704-48205-11</td> <td></td> </tr> <tr> <td>704-48205-12</td> <td></td> </tr> <tr> <td>704-48205-13</td> <td></td> </tr> <tr> <td>704-48205-15</td> <td></td> </tr> <tr> <td>704-48205-P0</td> <td></td> </tr> </tbody> </table> 	REF	YAMAHA 704	TRIM	REC704-48205-RO	704-48205-RO		704-48205-P1		704-48205-B1		704-48205-B0		704-48205-RO		704-48205-14	✓	704-48205-11		704-48205-12		704-48205-13		704-48205-15		704-48205-P0		<table border="1"> <thead> <tr> <th>REF</th> <th>YAMAHA 704</th> <th>TRIM</th> </tr> </thead> <tbody> <tr> <td rowspan="11">REC704-48207-RO</td> <td>704-48207-RO</td> <td></td> </tr> <tr> <td>704-48207-P1</td> <td></td> </tr> <tr> <td>704-48207-39</td> <td></td> </tr> <tr> <td>704-48207-31</td> <td></td> </tr> <tr> <td>704-48207-30</td> <td>✓</td> </tr> <tr> <td>704-48207-20</td> <td></td> </tr> <tr> <td>704-48207-21</td> <td></td> </tr> <tr> <td>704-48207-22</td> <td></td> </tr> </tbody> </table> 	REF	YAMAHA 704	TRIM	REC704-48207-RO	704-48207-RO		704-48207-P1		704-48207-39		704-48207-31		704-48207-30	✓	704-48207-20		704-48207-21		704-48207-22	
REF	YAMAHA 704	TRIM																																													
REC704-48205-RO	704-48205-RO																																														
	704-48205-P1																																														
	704-48205-B1																																														
	704-48205-B0																																														
	704-48205-RO																																														
	704-48205-14	✓																																													
	704-48205-11																																														
	704-48205-12																																														
	704-48205-13																																														
	704-48205-15																																														
	704-48205-P0																																														
REF	YAMAHA 704	TRIM																																													
REC704-48207-RO	704-48207-RO																																														
	704-48207-P1																																														
	704-48207-39																																														
	704-48207-31																																														
	704-48207-30	✓																																													
	704-48207-20																																														
	704-48207-21																																														
	704-48207-22																																														

CONECTORES DE CABLES	CABLE CONNECTOR	CAVO CONNETTORE	EMBOUT DE CABLE						
<table border="1"> <thead> <tr> <th>REF</th> <th>OEM</th> </tr> </thead> <tbody> <tr> <td>REC663-48344-00</td> <td>663-48344-00</td> </tr> </tbody> </table>  <p> 6&gt;115HP</p>	REF	OEM	REC663-48344-00	663-48344-00	<table border="1"> <thead> <tr> <th>REF</th> <th>OEM</th> </tr> </thead> <tbody> <tr> <td>PAF25-07000007W</td> <td>703-48345-01</td> </tr> </tbody> </table>  <p> 6&gt;115HP</p>	REF	OEM	PAF25-07000007W	703-48345-01
REF	OEM								
REC663-48344-00	663-48344-00								
REF	OEM								
PAF25-07000007W	703-48345-01								

**INTERRUPTORES PARA MANDOS**

**SWITCHES FOR ENGINE CONTROLS**

**INTERRUTTORI PER CONTROLLO**

**INTERRUPTEUR DE CONTRÔLE**

**INTERRUPTOR POWER TRIM (703)**

**POWER TRIM SWITCH (703)**

**INTERRUTTORE POWER TRIM (703)**

**COMMUTATEUR DE TRIM (703)**

REF	OEM
PAE4-10040100W	703-82563-00 703-82563-01 703-82563-02



new

**INTERRUPTOR PANEL SIMPLE (704)**

**SWITCH (704)**

**INTERRUTTORE PANNELLO SIMPLE (704)**

**TABLEAU DE COMMANDE SIMPLE (704)**

REF	OEM
REC704-82570-12	704-82570-12 704-82570-11 704-82570-10 704-82570-08 6E5-82570-05



new

**INTERRUPTOR PANEL COMPLETO O DOBLE ESTACIÓN**

**PANEL TWIN STATION**

**PANNELLO DOPPIA STAZIONE**

**BOITIER DE DEMARRAGE 2 MOTEURS**

REF	OEM
REC6K1-82570-13	6K1-82570-13 6K1-82570-12 6K1-82570-11 6K1-82570-10 6K1-82570-08 6K1-82570-07 6K1-82570-06 6K1-82570-05 6K1-82570-04 6K1-82570-03 6K1-82570-02 6K1-82570-00

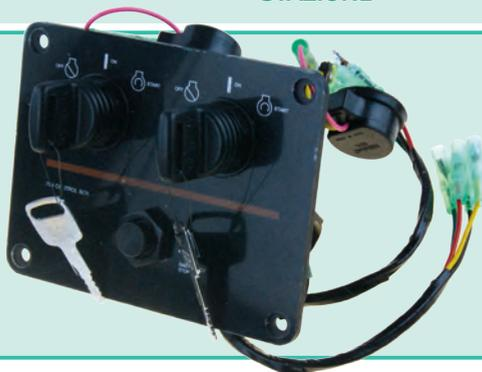

new

**ARNÉS**

**ARNES**

**CAVI**

**FAISCEAU ELECTRIQUE**

**EXTENSIÓN DE ARNÉS (703/704)**

**ARNES EXTENSION (703/704)**

**ESTENSIONE (703/704)**

**RALLONGE FAISCEAU (703/704)**

REF	OEM		PINS
REC688-8258A	688-8258A-10	2 m	10
REC688-8258A-30	688-8258A-30	3 m	10



new

**ARNÉS COMPLETO (703)**

**ARNES ASSY (703)**

**CAVO CONTROLLO COMPLETO (703)**

**FAISCEAU ELECTRIQUE BOITIER CDE (703)**

REF	OEM		PIN
PAF15-13000100W	688-82586-21	5 m	7
PAT85-08010100	688-8258A-20	5 m	10



PAF15-13000100W



PAT85-0801010

new

**COMPONENTES (703)**

**COMPONENTS (703)**

**COMPONENTI (703)**

**COMPOSANT (703)**

**ESPACIADOR**

**PLATE CONTROL BOX**

**DISTANZIALE**

**PLAQUE BOITIER DE COMMANDE**

REF	OEM
PAF15-11000002W	703-48293-10



**new**

**PALANCA ACELERADOR**

**THROTTLE HANDLE INCHING**

**LEVA ACCELERATORE**

**POIGNEE DE PAPILLON**

REF	OEM
PAF15-13020007W	703-48152-00



**new**

**CABLE DE ACELERADOR**

**THROTTLE CABLE**

**CAVO ACCELERATORE**

**CÂBLE D'ACCELERATEUR**

REF	OEM
REC6E0-26301-01	6E0-26301-01



4AC/A/AS  
5C/CS/CMH



REF	OEM
REC6B4-26301-00	6B4-26301-00



E15D  
E9.9D



REF	OEM
REC677-26301-02	677-26301-02



E8D  
E8DMH



REF	OEM
REC61N-26311-00	61N-26311-00



25B/BM/V  
30G/E30H



REF	OEM
REC6L2-26301-00	6L2-26301-00



9.9F/FM  
13.5AM  
15F/FM  
20D/M  
25N/NE/NW/D/M

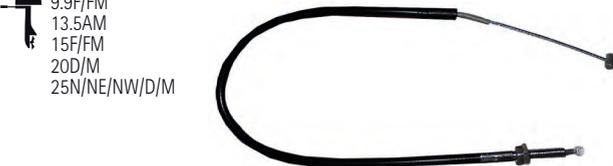

REF	OEM
REC6F5-26311-00	6F5-26311-00



E40G/J  
40G/J

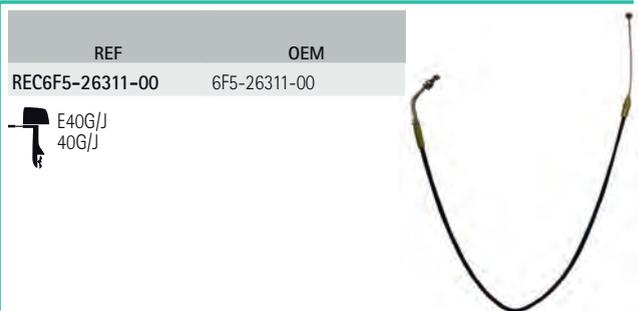

REF	OEM
REC66T-26301-00	66T-26301-00



40X/E40X



REF	OEM
REC692-26301-03	692-26301-00, 01,02,03



55B (1992-00)  
75A (1992-00)  
85A (1995-98)  
E75B (2003-16)  
E48C (2003)  
E60H (2001+)  
E55C (2003-16)  
F40J (2016+)

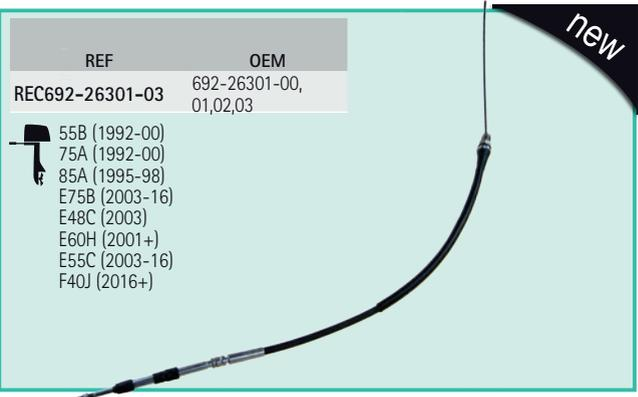

**new**

**PLACA CERRADURA SELECTOR**

**BLOCK CONTROL HANDLE**

**PLACCA SERRATURA SELETTORE**

**CALE POIGNEE DE CONTROLE**

REF	OEM
PAF15-13010010W	703-48245-00



new

**RUEDA ACELERACION**

**LEVER THROTTLE**

**RUOTA ACCELERAZIONE**

**ROUE D'ACCELERATEUR**

REF	OEM
REC663-42138-00	663-42138-00

- 55B/BET
- E55
- E60
- 75A5
- 85AE



**CABLES DE CONTROL**

**CONTROL CABLES**

**CAVI COMANDO**

**CÂBLES DE COMMANDE**

Recorrido trabajo: 76 mm.  
Rosca 10-32"

Travel 3"  
Threaded 10-32"

Estensione 76 mm  
Filetto 10-32"

Course: 76 mm.  
Fil 10-32

REF	RO	
PRE3300C05	YMM-21005-00-00	5' / 1,50 m
PRE3300C06	YMM-21006-C8-00	6' / 1,80 m
PRE3300C07	YMM-21007-C8-00	7' / 2,10 m
PRE3300C08	YMM-21008-C8-00	8' / 2,45 m
PRE3300C09	YMM-21009-C8-00	9' / 2,75 m
PRE3300C10	YMM-21010-C8-00	10' / 3,05 m
PRE3300C11	YMM-21011-C8-00	11' / 3,35 m
PRE3300C12	YMM-21012-C8-00	12' / 3,65 m
PRE3300C13	YMM-21013-C8-00	13' / 3,95 m
PRE3300C14	YMM-21014-C8-00	14' / 4,25 m
PRE3300C15	YMM-21015-C8-00	15' / 4,60 m
PRE3300C16	YMM-21016-C8-00	16' / 4,90 m
PRE3300C17	YMM-21017-C8-00	17' / 5,20 m
PRE3300C18	YMM-21018-C8-00	18' / 5,50 m
PRE3300C19	YMM-21019-C8-00	19' / 5,80 m
PRE3300C20	YMM-21020-C8-00	20' / 6,10 m
PRE3300C21	YMM-21021-C8-00	21' / 6,40 m
PRE3300C22	YMM-21022-C8-00	22' / 6,70 m
PRE3300C23	YMM-21023-C8-00	23' / 7,00 m
PRE3300C24	YMM-21024-C8-00	24' / 7,30 m
PRE3300C25	YMM-21025-C8-00	25' / 7,60 m
PRE3300C26	YMM-21026-C8-00	26' / 7,90 m
PRE3300C27	YMM-21027-C8-00	27' / 8,25 m
PRE3300C28	YMM-21028-C8-00	28' / 8,55 m
PRE3300C29	YMM-21029-C8-00	29' / 8,85 m
PRE3300C30	YMM-21030-C8-00	30' / 9,15 m

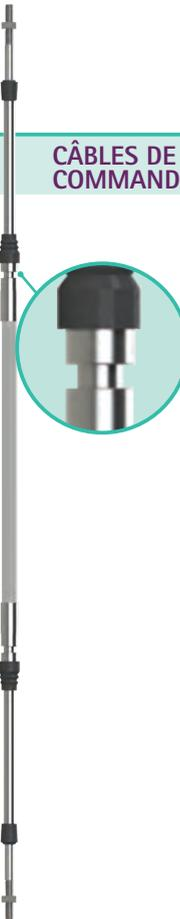
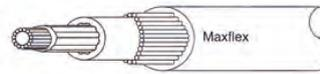

maxflex



**VARILLA DE ENLACE**

**LINK ROD ASSY**

**LEVA COLLEGAMENTO**

**BARRE D'ACCOUPEMENT COMPLETE**

REF	OEM
PAF25-07000300W	65W-61350-00

- F20A
- F25A
- FT25B
- F30A
- F40B/C/D
- F50F/H
- F60A/C/F
- FT50G/J
- FT60B/D/G
- F70A/40X



REF	OEM
PAF20-07000100W	63AH-61350-00

- F15C
- F20B



REF	OEM
GS41084	6E5-61301-00 6E5-61301-01



REF	OEM
PAF15-11020000W	63V-61350-00

- 9.9F
- 15F
- F9.9C
- FT9.9D
- F15A



MANETA ACELERADOR

LEVER, THROTTLE

LEVA COLLEGAMENTO

LEVIER DE COMMANDE

REF	OEM
PAF4-01090100	6G1-42138-00,01 6EG-62138-00



new

REF	OEM
PAF15-01030100	65W-42138-00



new

BRACKET

BRACKET ESTRIBOR

RIGHT BRACKET ASSY

BRACKET TRIBORDO

ETRIER DROIT

REF	OEM	STROKES	
		2T	4T
PAF15-01010200	63V-43112-00-4D		
	63V-43112-01-4D	✓	✓
	63V-W4311-00-4D	✓	✓
	63V-W4311-03-4D		
	63V-WS431-B6-8D		



9.9  
13.5  
15



new

BRACKET BABOR

LEFT BRACKET ASSY

BRACKET BABORDO

ETRIER GAUCHE

REF	OEM	STROKES	
		2T	4T
PAF15-01010100	63V-43111-00-4D		
	63V-43111-01-4D	✓	✓
	63V-43111-A2-4D		



9.9  
13.5  
15



new

SOPORTE GIRATORIO

BRACKET, ROTARY

SUPPORTO GIRATORIO

SUPPORT TOURNANT

REF	OEM	STROKES	
		2T	4T
PAF15-01010301S	63V-43311-00-4D		
	63V-43311-01-4D	✓	✓
	99999-03116		



9.9  
13.5  
15



new

SOPORTE BARRA DE DIRECCION

BOLT, CLAMP BRACKET

SUPPORTO BARRA DIREZIONE

TUBE SUPPORT CABLE DE DIRECTION

REF	OEM	STROKES	
		2T	4T
PAF15-01010001	63V-43131-00		
	63V-43131-10	✓	✓
	63v-43131-01		



9.9 - 60 Hp



new

TUERCA AUTOBLOCANTE

NUT, SELF-LOCKING

BULLONE AUTOBLOCCANTE

ECROU AUTO VERROUILLABLE

REF	OEM
PAF15-01010007	63V-43145-00
	90185-22043
	90185-22M11



**RETÉN INFERIOR DEL BRACKET**      **BRACKET OIL SEAL**      **ANELLO BRACCETTO**      **JOINT INFERIEUR DU SUPPORT**

REF	OEM	2T STROKES	4T STROKES
REC93109-44M00	93109-44M00	✓	

40 HP



*new*

**SOPORTE INFERIOR**      **SHELL, MOUNT DAMPER**      **SUPPORTO INFERIORE**      **SUPPORT SILENT BLOCK**

REF	OEM
PAF15-0000001	66M-44551-00-4D 63V-45551-00-4D

9.9  
13.5  
15



*new*

**VARILLA DE BASCULACIÓN**      **TILT ROD**      **ASTA BASCULANTE**      **BARRE DE TILT**

REF	OEM
REC676-43160-02	676-43160-00 676-43160-01 676-43160-02

40 - 55 HP

REF	OEM
REC688-43160-01	688-43160-01

40 - 90 HP



*new*

**CIRCLIP**      **CIRCLIP**      **CIRCLIP**      **CIRCLIP**

REF	OEM
PAGB/T896-9	93430-10M00 99080-10600

6L5



*new*

**CONECTOR**      **CONNECTOR**      **CONNETTORE**      **CONNECTEUR**

REF	OEM
REC682-41237-00	682-42137-00
REC682-41237-50	682-41237-50
REC663-85518-00	633-85518-00

REC682-41237-00      REC682-41237-50      REC663-85518-00





*new*

**EJE CONECTOR ACCELERADOR**      **THROTTLE SHAFT CONNECTOR**      **ASSE CONNETTORE ACCELERATORE**      **TIGE DE CONNEXION ACCELERATEUR**

REF	OEM
REC688-41211-01	688-41211-00 688-41211-01



*new*

ENGRASADOR INOX 316  
M6

OILER M6

INGRASSATORE

GRAISSEUR M6 INOX 316

REF	OEM
PAJB/T9740.1-M6	93700-06M03



new

BUJES

BUSHINGS

BOCCOLE

BAGUES

REF	OEM
PAF15-01010302	90386-22M15
REC90386-25M31	90386-25M31
PAF15-01000004	90386-30048
PAF25-01000004	90386-44M03
PAF25-01000001	90386-52M02
REC90386-30M77	90386-30M77



PAF15-01010302



REC90386-25M31



PAF15-01000004



PAF25-01000004



PAF25-01000001



REC90386-30M77



REF	OEM	
REC90386-22M13	90386-22M13	NYLON
PAT85-01010203	90386-10M16	NYLON
PAF25-01010002	90386-22M15	NYLON
PAT85-01020005	90386-30M77	NYLON
PAT85-00000017	90386-18M35	NYLON
REC90386-18M63	90386-18M63	NYLON
REC90386-22M98	90386-22M98	NYLON
REC90381-20001	90381-20001	NYLON
REC90386-38M89	90386-38M89	NYLON
PAF15-01000001	65F-42537-00	NYLON
PAF25-03000007	90387-06M69	METAL



REC90386-22M13



PAT85-01010203



PAF25-01010002



PAT85-01020005



REC90386-18M63



REC90386-22M98



REC90381-20001



REC90386-38M89



PAT85-00000017



PAF15-01000001



PAF25-03000007

new

COLLAR

WASHER, BELOW

COLLARE

CALLE

REF	OEM
PAF15-01000006	90386-30M60
PAT85-01020003	90386-30M78



PAF15-01000006



PAT85-01020003

new

YAMAHA

## MANDO ACELERADOR

## STEERING HANDLE ASSY

## MANIGLIA

## POIGNEE DE DIRECTION

REF	OEM
PAF4-01090300	68D-G2177-10 6EE-G2177-00



REF	OEM
REC6N0-G2177-00	6N0-G2177-00



## EJE DE CAMBIO

## HANDLE GEAR SHIFT ASSY

## LEVERAGGIO

## COMMANDE D'INVERSION

REF	OEM
REC688-44120-12	688-44120-11 688-44120-12



REF	OEM
REC692-44120-22	692-44120-21 692-44120-22



REF	OEM
REC688-44120-22	688-44120-22



## MANETAS Y FIJACIONES

## STARTER HANDLE AND FIXINGS

## MANIGLIE E CHIUSURE

## POIGNEE LANCEUR ET DE SERRAGE

REF	OEM
REC6L8-G3118-01	6L8-G3118-01



REF	OEM
REC648-44146-00	648-44146-00

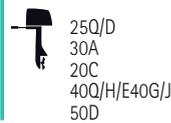

REF	OEM
REC99999-02808	99999-02808



REF	OEM
REC689-15755-00	689-15755-00



REF	OEM
REC6E0-43118-01	6E0-43118-00 6E0-43118-01



REF	OEM
REC650-44147-00	650-44147-00



REF	OEM
REC663-43118-01-4D	663-43118-01-4D





SILENBLOCK

SILENBLOCK

SILENBLOCK

SILENT BLOC

REF	OEM
REC63V-44514-01-CA	63V-44514-01-CA

 9.9F/FM/MS  
 13.5AMH  
 15F/FM/MS



REF	OEM
REC66T-44514-00-4D	66T-44514-00-4D

 40X  
 E40X/M



REF	OEM
REC670-44514-00	670-44514-00

 55B  
 E55CMH



REF	OEM
PAF15-00000002	682-44555-30

 6 HP  
 8 HP  
 9.9 HP  
 15 HP

*new*



REF	OEM
REC670-44555-00-94	62Y-44555-00

 E48CM  
 E55CM



REF	OEM
PAF15-00000003	66M-44557-00

 9.9 HP  
 13.5 HP  
 15 HP

*new*



REF	OEM
REC679-44514-00-94	679-44514-00-94

 40QE/QWC/G/J  
 E40G/J



REF	OEM
PAF15-02010000	66M-44514-00-4D

 9.9 HP  
 13.5 HP  
 15 HP

*new*



REF	OEM
REC682-44514-01-94	682-44514-01-94

 E9.9DMH  
 E15DMH



REF	OEM
REC663-44551-02-8D	663-44551-02-8D

 F50DETL  
 75CETO  
 90AETO/TRH



REF	OEM
REC688-44514-00	688-44514-00

 E60HMHD  
 70BETO  
 75CETO  
 90AETO



REF	OEM
REC676-44518-00	676-44518-00

 E40G/J  
 40G/J  
 40G



REF	OEM
REC688-44555-00	688-44555-00

 60FE/FET  
 70CE/ETN  
 E75B  
 80A  
 85A



# SISTEMA DE REFRIGERACIÓN COOLING SYSTEM

# SISTEMA DI RAFFREDDAMENTO SYSTÈME DE REFROIDISSEMENT

## LÍQUIDO INHIBIDOR DE LA CORROSIÓN

## SALT OFF

Diseñado especialmente para eliminar sedimentos de sal de cualquier superficie pintada, de metal, fibra de vidrio, vinilo, caucho, cristal o plástico. Es el método más eficaz para proteger los motores, los aparos de pesca... Genera una capa de polímeros que evita futuras sedimentaciones.

It is specifically formulated to quickly and effectively remove salt deposits from metal, fiberglass, plastic or painted surfaces. It contains special polymers that bond to the treated surface to help prevent the formation of future deposits.

## LIQUIDO INIBITORE DELLA CORROSIONE

## SALT OFF

Appositamente progettato per rimuovere depositi di sale da qualsiasi superficie verniciata, metallo, fibra di vetro, vinile, gomma, vetro o plastica. È il metodo più efficace per proteggere motori, attrezzi da pesca... Genera uno strato di polimeri che impedisce la futura sedimentazione.

La protection SALT OFF est formulé pour éliminer les dépôts de sel sur toutes les surfaces marines. Utilisable pour le rinçage des moteurs hors bord et inboard et les embases. Il laisse un film de protection spécial pour prévenir des attaques futures du sel.

new



REF  
STA94100

Star brite



REF	Image	Volume
STA93900		3,78 L
STA93922		650 ml
STA93932		1 L

STA93900



STA93932



STA93922

## TERMOSTATO

## THERMOSTAT

## TERMOSTATO

## THERMOSTAT

### TERMOSTATO

### THERMOSTAT

### TERMOSTATO

### THERMOSTAT

REF	OEM	°C
REC6DA-12411-01	6DA-12411-01	60°



new

REF	OEM	°C
REC6FM-12411-00	6FM-12411-00	60°



new

REF	OEM	°C
REC6AH-12411-00	69M-12411-01	60°
	69M-12411-00	
	6AH-12411-00	



REF	OEM	°C
REC6E5-12411-02	6E5-12411-00	50
	6E5-12411-01	
	6E5-12411-02	



REF	OEM	°C
REC6D9-12411-00	6D9-12411-00	55°



**new**

REF	OEM	°C
REC6E5-12411-30	6E5-12411-30	50°
	6E5-12411-20	
	6E5-12411-10	



REF	OEM	°C
REC6CE-12411-00	6CE-12411-00	52°



**new**

REF	OEM	°C
PAF15-07000031	66M-12411-00	60°
	66M-12411-01	



REF	OEM	°C
REC6AW-12411-00	6AW-12411-00	60°



**new**

REF	OEM	°C
REC6H3-12411-10	6H3-12411-00	60°
	6H3-12411-01	
	6H3-12411-10	
	6H3-12411-11	



REF	OEM	°C
REC6FP-12411-00	6FP-12411-00	60°



**new**

REF	OEM	°C
REC67F-12411-01	67F-12411-00	60°
	67F-12411-01	



REF	OEM	°C
REC6F5-12411-03	6F5-12411-00	60°
	6F5-12411-01	
	6F5-12411-02	
	6F5-12411-03	



**new**

REF	OEM	°C
REC60V-12411-00	60V-12411-00	50°



**GUÍA TERMOSTATO**

**THERMOSTAT GUIDE**

**GUIDA TERMOSTATO**

**GUIDE DES THERMOSTATS**

	REF
3A/ 4A/ 5C/ 6C/ 8C/ 25N (-1993)/ 25NWO	REC6E5-12411-02
9.9F/ 15F/ 25N(1994+)/30D/ 40V/ 75C/ 90A/ 100A/ 115C/ 130B/ 150F/ 175D/ 200F/G/ 225D/G/ 250A/B/ Z150P/Q/ Z175G/ Z200N/P	REC6E5-12411-30
F2.5A/ F9.9H/ F13.5B/ F15C/ F20B,M	REC6AH-12411-00
9.9D/ 15D/ 20C/ 25D/ 40Q/ 55B	REC6F5-12411-03
F15C/F20D	REC6AH-12411-00
F25G	REC6FM-12411-00
50G/ 60F/ 70B	REC6H3-12411-10
F4A/B/ F5A/ F6A/C/ F8B/C/ F18D/ F9.9B/C/F/J/ FT9.9A/D/G/L/ F15A/ F25A/D/ FT25B/F/ F30A/B/ F40A/B/F/ F50A/F/H/ FT-50B/C/G/J/ F60A/C/F/ FT60B/D/G/ F70A/ F80A/ F100A(2000-)	PAF15-07000031

	REF
F80A/B/ F100A(01+)/ F100B/ F(L)150A/ F(L)200A/C/ F(L)225A/B/C/ F(L)250A/B	REC67F-12411-01
F100D	REC6D9-12411-00
F100F	REC6FP-12411-00
F(L)225F/ F(L)250D/ F(L)300B	REC6CE-12411-00
F(L)200F/ F(L)200G/ F175A	REC6DA-12411-01
F(L)300A/ F(L)350A	REC6AW-12411-00
F100B/ F(L)115A/ (L)2250D/F/ Z300A	REC60V-12411-00

JUNTAS TERMOSTATO

THERMOSTATO GASKETS

GUARNIZIONI TERMOSTATO

JOINTS DE THERMOSTAT

**new**

REF	OEM
REC63P-12414-00	63P-12414-00

F150A/B/D/F/T (2004+)

**new**

REF	OEM
PAF20-05000702	6AH-12414-00

F9.9 -F20 (New models)

REF	OEM
PAF4-04000011	68D-E2414-A0

F2.5  
F4  
F5  
F6

REF	OEM
REC655-12414-A1	655-12414-A1

20C/CM  
E25A  
E25BMH  
25VE/VM/DE/D/B/BMH/BWH/HMH  
30G/GE/A  
E30HMH  
30HMH/HWH/HWL

REF	OEM
REC6G8-12414-A0	6G8-12414-A0

T8/T9.9  
F6/8/9.9  
FT8/9.9

REF	OEM
REC676-12414-A0	676-12414-A1

40X/E40X/E40MLH

REF	OEM
PAF15-07010022	62Y-12414-00
REC6H3-12414-A1	6H3-12414-A1

F9.9  
F60  
F30  
F13.5  
F70  
FT9.9  
T9.9TLR  
FT25  
FT50

FT60  
F15/20/25/40/45/50  
T50TLR  
T60TLR  
T25TLR

REF	OEM
REC6E9-12414-A1	6E9-12414-A1

40QE/QM/QEZ/QWC/GWH/JWH  
E40GMH/JMH

REF	OEM
REC682-12414-A1	682-12414-A1

9.9D/F/FMH/FEMH/MH/MSH  
15D  
E9.9DMH  
13.5AMH  
15F/FEMH/FMH/MSH/MH  
E15DMH

REF	OEM
REC663-12414-00	663-12414-A0

E48CMHS  
55B/BET/BE/BM  
E55CMH

REF	OEM
REC61A-12414-A0	61A-12414-A0

20DM/MSH  
25J/JETO/NEM/NWC/D/DM  
30D/DMH  
40V/VMH/VEO  
C40MLH/T  
50H/HM  
225C/CET/FETO/G  
250AET/B/TXR/G/GETO

REF	OEM
REC688-12414-A1	688-12414-A1

75CETO/AE  
E75B  
80AE/A  
85AE/A  
90AE/TLR  
100A/TLR  
115BE/B  
115A/AETO/CET  
130BETO/TLR  
150F/TXRA/FETO/C

Z150  
175D/DETO/DETO  
Z175  
225D/DETO  
VZ200  
Z200  
200AET/CETO/F/  
FETO/G/GETO

**CUBIERTAS TERMOSTATO**    **THERMOSTATO COVER**

REF	OEM	
REC6E9-12413-00-1S	6E9-12413-00-1S	REC6E9-12414-A1

E40/40J (2003+)



*new*

REF	OEM	
REC688-12413-00-1S	688-12413-00-1S	REC688-12414-A1



*new*

**COPERCHIO TERMOSTATO**    **COUVERCLE DE THERMOSTAT**

REF	OEM	
REC682-12413-00-1S	682-12413-00-1S 682-12413-00-9M	REC682-12414-A1

E40/40J (2003+)



*new*

**VÁLVULA ANTIPRESIÓN DE TERMOSTATO**    **THERMOSTAT, PRESSURE VALVE**

REF	OEM	O-RING	OEM
REC688-12416-00	688-12416-00	REC90480-20M05	90480-20M05

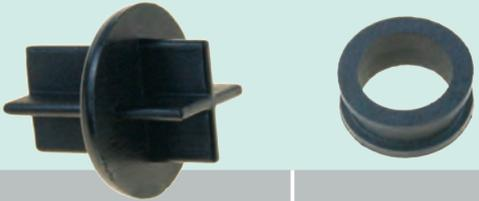

*new*

**VALVOLA ANTI-PRESSIONE DE TERMOSTATO**    **SOUPAPE DE PRESSION DE THERMOSTAT**

**RESORTE**    **SPRING**    **MOLLA**    **RESSORT**

REF	OEM
REC90501-16M11	90501-16M11

75 / 85 / 90A

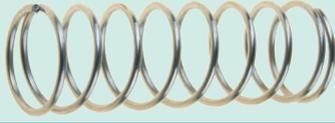

*new*

**NIPLE**    **NIPPLE**    **NIPLE**    **TETINE**

REF	OEM
PAF15-05000009	6H3-44391-00 6H3-44391-01 6BL-44391-00



*new*

**JUNTAS TAPA, DE REFRIGERACIÓN**

**GASKET, EXHAUST INNER COVER**

**GUARNIZIONE COPERCHIO REFRIGERAZIONE**

**JOINT DE PLAQUE DE REFRIGERISSEMENT**

REF	OEM
REC6E0-41114-A1	6E0-41114-A1

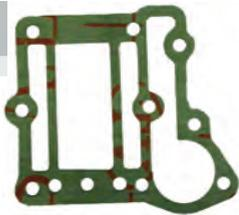

REF	OEM
REC6E0-41112-A1	6E0-41112-A1

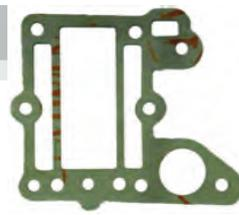

REF	OEM
REC6G1-41112-A1	6G1-41112-A1

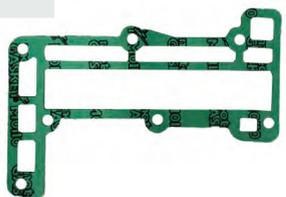

REF	OEM
REC6G1-41114-A0	6G1-41114-A0

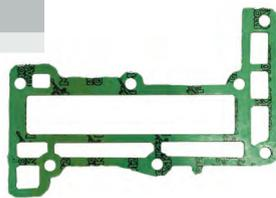

REF	OEM
REC6G1-11193-A1	6G1-11193-A1



REF	OEM
REC6G8-41112-02	6G8-41112-02



REF	OEM
REC6G8-41114-00	6G8-41114-00



REF	OEM
REC677-41112-A0	677-41114-A0



REF	OEM
REC6B4-11193-A0	6B4-11193-A0

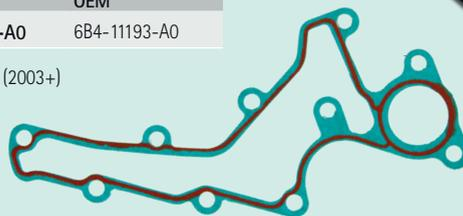

new

REF	OEM
REC682-41114-00	682-41114-A1



REF	OEM
REC682-41112-00	682-41112-A1



REF	OEM
PAF15-07010018	66M-41114-01



REF	OEM
REC63V-41112-A0	63V-41112-A0



REF	OEM
REC664-41114-A0	664-41114-A0

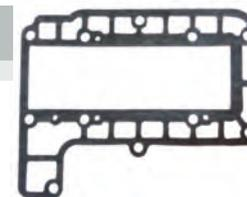

REF	OEM
REC6L2-41114-A1	6L2-41114-A1

 20D/M  
25N/M/D

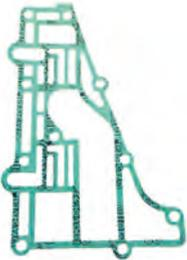

REF	OEM
REC6K8-41122-A1	6K8-41122-A1

 25VE/M/B/BMH  
E25A  
30HM/HW/G/GE  
E30HMH

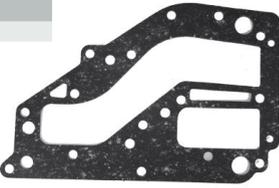

REF	OEM
REC6L2-41112-A3	6L2-41112-A2

 20D/M  
25N/M

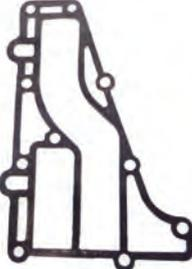

REF	OEM
REC6K8-41124-A1	6K8-41124-A1

 25VE/M/B/BMH  
E25A  
30HM/HW/G/GE  
E30HMH

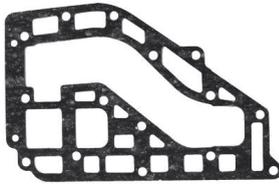

REF	OEM
PAF25-05010111	65W-41114-00

 F20/25  
T25

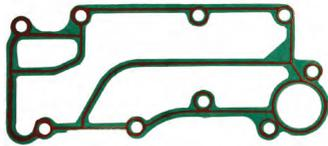

REF	OEM
REC689-41112-A0	689-41112-A0

 30A

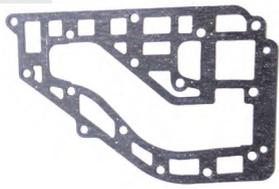

REF	OEM
REC6H3-41112-A0	6H3-41112-A0

 25B  
50G/GE  
60FE/TLR  
E60H  
70B/BE/TR



REF	OEM
REC689-41114-A0	689-41114-A0

 30A



REF	OEM
REC6H3-41114-A0	6H3-41114-A0

 25B  
50G/GE  
60FE/TLR  
E60H  
70B/BE/TR

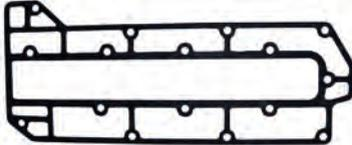

REF	OEM
REC67C-41114-00	67C-41114-00

 F30/40



REF	OEM
REC6H4-41112-A0	6H4-41112-A0

 25QEO  
40H/M/VE/TLR  
C40M/T  
50H/DE

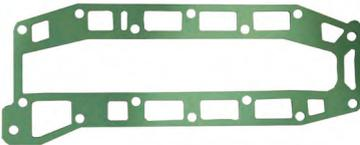

REF	OEM
REC66T-41114-A0	66T-41114-A0

 40X  
E40X

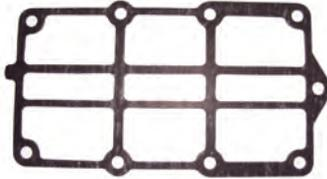

REF	OEM
REC6H4-41114-A0	6H4-41114-A0

 25QEO  
40H/M/VE/TLR  
C40M/T  
50H/DE

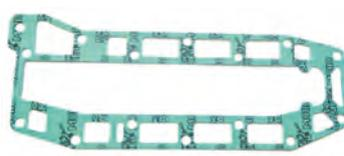

REF	OEM
REC6F5-41112-A0	6F5-41112-A0

 40GWH/JMH  
E40GMH



REF	OEM
REC6F5-41114-A0	6F5-41114-A0

 40GWH/JMH  
E40GMH

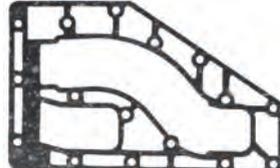

REF	OEM
REC6E5-41112-A1	6E5-41112-A1

 100A/AET/TLR  
115B/BE/TLR/CEO/TXR  
130BET/TLR



REF	OEM
REC6E9-41114-A0	6E9-41114-A0

 40Q

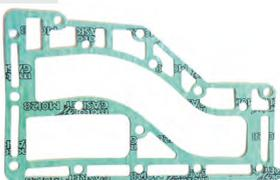

REF	OEM
REC6G5-11382-A1	6G5-11382-A1

 115HP-250HP



REF	OEM
REC676-41112-A0	676-41112-A0

 40Q

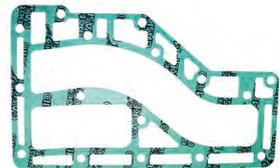

REF	OEM
REC6G5-41112-A1	6G5-41112-A1

 150F/FE/TXR/GE/A-CE,  
175D/DE/FE  
200AET/F/FE/TLR/G/GE/BE  
225D/DE/BE



REF	OEM
REC663-41114-00	663-41114-A0

 55B  
E55CMH



REF	OEM
REC68F-41114-00	68F-41114-00

 Z150  
175  
200HP

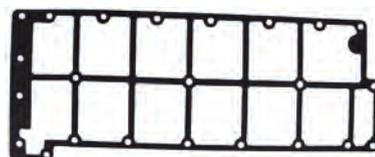

REF	OEM
REC688-41112-A0	688-41112-A0

 75CET/TLR/AE  
E75B  
80AE  
85A/AE  
90A/AE/TLR

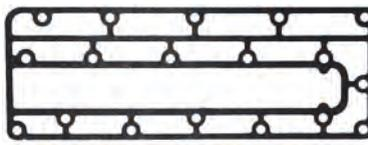

REF	OEM
REC6G5-41114-A0	6G5-41114-A0

 150F/FE/TXR/GE/A-CE,  
175D/DE/FE  
200AET/F/FE/TLR/G/GE/BE  
225D/DE/BE



REF	OEM
REC688-41114-A0	688-41114-A0

 75CET/TLR/AE  
E75B  
80AE  
85A/AE  
90A/AE/TLR

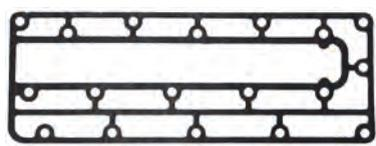





	REF	CEF	OEM	A	B	C
2A/B/C	REC646-44352-01	CEF500324	646-44352-01	11,5	47,5	13,7
F2.5, 3A, MALTA	REC6L5-44352-00	CEF500322	6L5-44352-00	10	36	14,5
4A/B, F4A, F4B, F5A, F6C, 5C	REC6E0-44352-00	CEF500325	6E0-44352-00	11	40	12,6
F6A/B, F8C, F9.9F, F9.9J	REC68T-44352-00	CEF500368	68T-44352-00	11,6	53	14
E8D	REC662-44352-01	CEF500321	662-44352-01	14	40	22
6C/D, 8C	REC6G1-44352-00	CEF500302	6G1-44352-00	11,9	40	18
F8, F9.9A/B/D, FT9.9A, 15D/9.9D	REC682-44352-01	CEF500320	682-44352-03	13	40	22
FT8D, 9.9F, F9.9C, FT9.9D, 15F, F15A-C, F20B, FT9.9G/L	REC63V-44352-01	CEF500363	63V-44352-01	12,85	53	14
20C, 25D, 30A	REC689-44352-02	CEF500326	689-44352-02	16,5	69,5	12,72
20D, 25N	REC6L2-44352-00	CEF500384	6L2-44352-00	13,97	51,2	19,05
F20A, F25A/D/G, FT25B, 25B/J/V, F30A, 30D/H/G, F40B/F, 40H/X, 50D	REC6H4-44352-02	CEF500385G	6H4-44352-02	16,1	51,2	19,05
F40A/C, 40V/F/Y, F45A, 50G/H, 55B, PRO50, F50A/B/F, FT50B/C/G, F50H, FT50J, F60A/C/F, FT60B/D/G, 60F, 70B, F70A	REC6H3-44352-00	CEF500316	6H3-44352-00	18,05	51,8	19
40Q	REC6F5-44352-00	CEF500352	6F5-44352-00	16,04	69,8	22,1
60F'04-, 70B'04-, 75A/C, PRO75, 80A, 85A, 90A	REC688-44352-03	CEF500323	688-44352-03	20,1	58	30
F80A/B, F100A/D	REC67F-44352-00	CEF500364	67F-44352-00	20	58,2	34,7
F(L)115A/F(L), 150A, V4/V6, F100F, F175, 200F/G	REC6E5-44352-01	CEF500371	6E5-44352-01	22,4	89	31
F(L)225F, F(L) 250D, F(L)300B	REC6CE-44352-00	CEF500401N	6CE-44352-00	22,5	90	36
F300, F350	REC6AW-44352-00	CEF500389N	6AW-44352-00	24,6	89	36

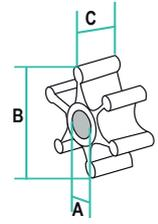

REC646-44352-01



REC6L5-44352-00



REC6E0-44352-00



REC68T-44352-00



REC662-44352-01



REC6G1-44352-00



REC682-44352-01



REC63V-44352-01



REC689-44352-02



REC6L2-44352-00



REC6H4-44352-02



REC6H3-44352-00



REC6F5-44352-00



REC688-44352-03



REC67F-44352-00



REC6E5-44352-01



REC6CE-44352-00



REC6AW-44352-00

KITS DE JUNTAS

GASKETS KIT

KIT GUARNIZIONE

KITS JOINTS

YAMAHA

REF	OEM
REC6A1-W0001-22	6A1-W0001-22

2B

REF	OEM
REC6A1-W0001-23	6A1-W0001-23

2B  
2MSH

REF	OEM
REC6E0-W0001-C1	6E0-W0001-C1

F4/F5/F6  
4AC  
MSH  
5C/CS/CMH

REF	OEM
REC6G1-W0001-C1	6G1-W0001-C0

6C/CMH/MSH/TRV/D/DMH  
8C/MSH/CMH/TRV

REF	OEM
REC68T-W0001-20	68T-W0001-20

F6/F8/F9.9

REF	OEM
REC6G9-W0001-C4	6G9-W0001-C4

F8  
F9.9

REF	OEM
REC69G-W0001-20	69G-W0001-20

FT8/T8  
FT9.9/T9.9

REF	OEM
REC6G9-W0001-C6	6G9-W0001-C6

F8  
F9.9

REF	OEM
REC66M-W0001-20	66M-W0001-20

F9.9  
F13.5  
F15

REF	OEM
REC683-W0001-21	683-W0001-C1

9.9D/15D

REF	OEM
REC63V-W0001-21	63V-W0001-21

9.9/15F  
13.5AWH

REF	OEM
REC689-W0001-C2	6689-W0001-C2

 20C/CM  
 25D  
 30A

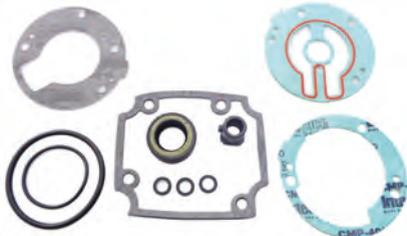

REF	OEM
REC6L2-W0001-C3	6L2-W0001-C3

 25D/NWC/MLH/MSH



REF	OEM
REC689-W0001-21	689-W0001-21

 55B



REF	OEM
REC61N-W0001-E1	61N-W0001-E1

 25V/VM/E25A  
 30G/GE



REF	OEM
REC698-W0001-21	698-W0001-21

 E48  
 E48CMH  
 55B/BM/BET  
 E55CMH



REF	OEM
REC6J8-W0001-21	6J8-W0001-21

 25J  
 30D/DMH

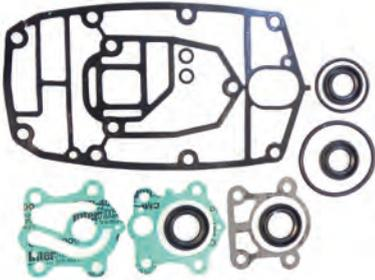

REF	OEM
REC689-W0001-20	689-W0001-20

 55BET



REF	OEM
REC6H3-W0001-22	6H3-W0001-22

 25B/BETO  
 50G/GEO/GETO  
 60FETO/FEDO/FE0/F/TLR  
 70B/BETO/BEMO



REF	OEM
REC65W-W0001-20	65W-W0001-20

 F20/25



REF	OEM
REC67F-W0001-20	67F-W0001-20

 F100A/T  
 F80A/T



REF	OEM
REC62Y-W0001-22	62Y-W0001-20,-21,-22

 F40A, ELH/F45AE, AET/F50A, AET, AED, AEDH, AEHT, TJR, TJRB, TLR, TLRA, TLRC, TLRZ, TLHC/FT50B/T50TLR (2000-07)



REF	OEM
REC64J-W0001-21	64J-W0001-21

 FT50, T50



REF	OEM
REC6F5-W0001-C0	6F5-W0001-C0

 40G/E40G



REF	OEM
REC69D-W0001-20	69D-W0001-20

 E60H

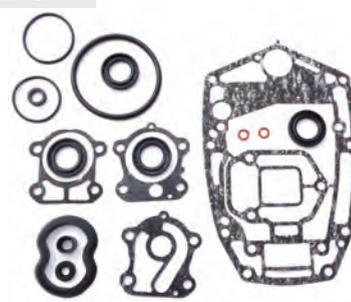

REF	OEM
REC66T-W0001-20	66T-W0001-20

 40X/E40X-MH/XW E40MCH



REF	OEM
REC6H2-W0001-20	6H2-W0001-20

 60FETO/TR 70BETO/TR

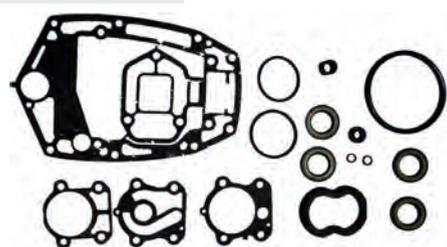

REF	OEM
REC6A0-W0001-21	6A0-W0001-21

 400E/G



REF	OEM
REC688-W0001-22	688-W0001-22

 75CETO/E75B/AED 85A/AED/AET 90AETO/TR



REF	OEM
REC64J-W0001-20	64J-W0001-20

 F45/50 FT50 T50



REF	OEM
REC688-W0001-20	688-W0001-20

 75A/AE 80A 85A/AE 90A/AEO/AETO/ETN



REF	OEM
REC68V-W0001-20	68V-W0001-20

F115

REF	OEM
REC69J-W0001-20-00	69J-W0001-20

F200/225

REF	OEM
REC6E5-W0001-F1	6E5-W0001-F1 6E5-W0001-21 6F3-W0001-21

115BETO/B/CEO/CETO/TXR  
130BETO  
E115AE

BOMBA DE AGUA

WATER PUMP

POMPA ACQUA

POMPE À EAU

CUERPO BOMBA DE AGUA HOUSING, WATER PUMP

CORPO, POMPA ACQUA

CORPS DE POMPE À EAU

REF	OEM
PAF2.6-03000014	69M-G4311-00

F2.5

P. 283

REF	OEM
PAF20-04040001	6AH-44311-00

F9.9 / 13.5 / 15/20 F  
Última versión  
Last version  
Ultima versione  
Dernière version

P. 293

new

REF	OEM
PAF4-03000019	68D-G4311-01

F4

P. 285  
P. 343

REF	OEM
REC689-44311-00	689-44311-03

20C/CM  
25D/DE  
30A

P. 353

REF	OEM
REC63V-44301-00	63V-44301-00-00

F6/8/15/9.9/13.5  
T8/9.9  
9.9F/FEM/MH/MSH/FMH  
13.5AWH  
15F/FMH/MSH/MH

P. 289  
P. 291  
P. 351

REF	OEM
REC663-44311-02	663-44311-02-00

25B/BETO  
40N/H/E  
50G/GEO/GETO  
50D  
55B/BET  
E55CMH  
60FEO/FETO/FEDO

60BE/BEM/BET  
70CE

P. 357  
P. 359  
P. 369

REF	OEM
PAF25-04050001	61N-44311-01

 25V  
 30G  
 F20  
 F25

 P. 297  
 P. 355



REF	OEM
REC688-44311-01	688-44311-01

 60FETO/TR  
 E60H-E-M  
 70BETO/TR  
 75CETO/TLR  
 E75B  
 75A/AE-T-M-D  
 80A/AE-O-T  
 85A/AE-D-T  
 90A/AETO/AEO/TLR

 P. 371  
 P. 373



REF	OEM
REC63D-44311-01	63D-44311-00

 40V/VM/VE/TLR  
 C40M-T  
 50H/HR-M/HM  
 F40/45/50/60

 P. 309  
 P. 315



REF	OEM
REC67F-44311-01	67F-44311-01-00

 F80/100

 P. 321



REF	OEM
REC676-44311-00	676-44311-00

 E40GM/JM  
 40GW/JW/G/QE/QWC



REF	OEM
REC61A-44311-00	6E5-44311-00

 F80/100/115/150/200/225/250  
 150F/FET/TR/AET  
 Z150P/TXR  
 175D 200F/FETO/G/GETO  
 200AET  
 225B/DET/G  
 250GETO/AET  
 Z250DET/FET

 P. 325  
 P. 329  
 P. 333  
 P. 339  
 P. 377  
 P. 381  
 P. 385  
 P. 386



REF	OEM
PAT40-04000201	66T-44311-00

 40X/E40X-MLH  
 T25/FT25  
 F30/F40

 P. 305  
 P. 301

**new**



REF	OEM
REC6CE-44311-01	6CE-44311-00 6CE-44311-01

 F250 (2011+) V6  
 F300 (2011+) V6

 P. 335

**new**



REF	OEM
REC6H3-44311-00	6H3-44311-00

 FT/T 50/60 HP (1997+)  
 60F (1984-99)

**new**



REF	OEM
REC6AW-44311-01	6AW-44311-00 6AW-44311-01

 F300 (2008-11) V8  
 F350 (2008+) V8

 P. 341

**new**



## TAPA DE LA BOMBA

## WATER PUMP, COVER

## COPERCHIO POMPA

## PLAQUE DE POMPE À EAU

REF	OEM
REC646-44323-00	646-44323-00

 2B  
 2MSH  
 2BMH



REF	OEM
PAF2.6-03000010	69M-G4323-00

 F2.5



REF	OEM
REC6L5-44323-00	6L5-44323-00



3A/AMH  
3MSH



REF	OEM
REC676-44323-00-40	676-44323-00



E40GMH/GW/JMH  
40JWH/GWH  
40QE/G/QM/QE-2/QWC



REF	OEM
REC67F-44323-00	67F-44323-00



F75/F80/F100



REF	OEM
REC66T-44323-00	66T-44323-00



40X/E40X/MLH  
40XW/XMH  
F30/40/T25



REF	OEM
REC68T-44323-00	68T-44323-00



F6  
T8  
F9.9  
F20/6/9.9/8/13.5  
T8/9.9



REF	OEM
REC663-44323-00	663-44323-00



50G/GE0/GETO  
25Q/QE0/B  
55B/BE/BM  
30DET/DE0/DMH/ELH  
60FEO  
FETO  
FEDO  
70BEO/BETO/BEMO/CE  
40N/H

50ETN/D/DE  
25J/JEO/JETO/ESH  
25Q/QE0/E55CMH  
30DET/DE0/DMH/D  
55B/BM/BET  
40E/H  
50D/DE  
25J/JEO/JETO/ESH



REF	OEM
REC63V-44323-00	63V-44323-00-00



9.9F/FMH/FEMH/MSH  
F9.9/13.5/15  
13.5AWH  
15F/FM/MS



REF	OEM
REC688-44323-00	688-44323-00-00



60FET/TR  
75CETO/AED-T  
70BET/TR  
75A/AE-M/TLR/CETO/AED-T  
E75B

80A/AET/TLR  
85A/AE-D-T  
90A/AET/ETN/TR



REF	OEM
REC6H3-44323-00	6H3-44323-00-00



25B/BETO  
F45  
50G/GE  
T50  
F50

FT50  
60FE/TLR  
FT60  
T60  
70B/ETN/BE



REF	OEM
REC6E5-44323-00-40	6E5-44323-00



100A/AETO/TLR  
115CET/A/B/BET  
C115TLR  
130BET  
140AET/BET



REF	OEM
REC61N-44323-00	61N-44323-00



25B/BMH/30H  
E30HM  
30G  
E25A

25VE-M  
F20/F25



REF	OEM
REC68V-44323-00	6EK-44323-00



F115



REF	OEM
REC6P2-44323-00	6P2-44323-0



Z250  
F225/F250



REF	OEM
REC6G5-44323-00	6G5-44323-01



F150/200/225  
Z150/175/250/300  
VZ200  
250AET/B/GET  
225C/CET/D/DET  
150F/FET/AET

175D/DET/AET  
200F/FET/GE  
225G  
200AET/BET  
150CET  
175BET



REF	OEM
REC63D-44323-00	63D-44323-00-00



F30/40/45/50/60  
40V/VE-M/Y/YE  
C40MLH/T  
T50  
50H/HM-R



**KITS DE REPARACIÓN BOMBA DE AGUA**

**WATER PUMP SERVICE KITS**

**KIT RICAMBI POMPA ACQUA**

**KIT REPARATION DE POMPE A EAU**

REF	OEM
REC6E0-W0078-A2	6E0-W0078-A2 6E0-W0078-00 6E0-W0078-01 6E0-W0078-02

**new**

REF	OEM
REC69G-W0078-01	69G-W0078-01 69G-W0078-00

FT/T8 D/P/E/M/G (2005+)  
FT/T9.9 E/G/M/L (2008+)

**new**

REF	OEM
REC6A1-W0078-01	6A1-W0078-01

2B (1985-88)

**new**

REF	OEM
REC6AH-W0078-00	6AH-W0078-00 6AH-W0078-01

F9.9 (2009+)  
F13.5B (2007-09)  
F15C/E/M (2007+)  
F20B/M (2007+)

**new**

REF	OEM
REC6EE-W0078-01	6BX-WG0078-00 6EE-W0078-00 6EE-W0078-01

F4B/M (2010+)  
F5A/M (2010+)  
F6C/M (2010+)

**new**

REF	OEM
REC63V-W0078-01	63V-W0078-00

9.9F  
13.5AWH  
15F  
F9.9  
F15  
F13.5

**new**

REF	OEM
REC68T-W0078-00	68T-W0078-01 68T-W0078-00

F6A/B/M (2005-09)  
F8C/F/M (2005+)  
F9.9 F/M/J (2008+)

**new**

REF	OEM
REC682-W0078-A1	682-W0078-A1

9.9/15D  
F8  
F9.9

**new**

REF	OEM
REC6G1-W0078-A1	6G1-W0078-A1 6G1-W0078-00 6N0-W0078-A0 6G1-W0078-01

6C/D/M/T (1984-14)  
8C/N/J/F/T/M (1984-18)

**new**

REF	OEM
REC61N-W0078-11	61N-W0078-11 61N-W0078-10

F20A/D (1998-17)  
F25A/E/T/M/D (1998-18)

**new**



REF	OEM
REC689-W0078-04	689-W0078-04

20CM

REF	OEM
REC6BG-W0078-00	6BG-W0078-00

F30B (2009+)  
F40A/F (2009+)

REF	OEM
REC689-W0078-A6	689-W0078-A6

20C  
25D

REF	OEM
REC6CJ-W0078-00	6CJ-W0078-00

F40G (2011+)  
F70A (2011+)

REF	OEM
REC6L2-W0078-00	6L2-W0078-00

20NE/NEMO/N/MLH/MSH/NW/NMH/D  
20D/DEO/DEM/MSH/DM/MLH  
20MSH/DMH/DWO

REF	OEM
REC63D-W0078-01	63D-W0078-01

40V/C40 (1998+)  
50H (1997-03)  
F45A (1997-00)  
F50A/H/F/T (1997+)  
F40A/E/Y/D/H (1999+)  
F60A/B/C/T (2002+)  
F40/45/50/60  
40V/MMH/VETO/MMH  
C40MLH/T/TLR  
40VE/VEO/VES  
40Y/YETO  
50H/HET/HMH

REF	OEM
REC6J8-W0078-A2	6J8-W0078-A1

25J/JEO  
30D/DE/DMH

REF	OEM
REC679-W0078-A1	679-W0078-00

40QE

REF	OEM
REC6H4-W0078-00	6H4-W0078-00

25Q/QEO  
40N/H/HE  
E48CMH  
50D/DE/AETN  
E55CMH

REF	OEM
REC6F5-W0078-A0	6F5-W0078-00

E40GMH  
40GWH

REF	OEM
REC66T-W0078-00	66T-W0078-01

40X  
E40X

REF	OEM
REC67F-W0078-00	67F-W0078-00

F80/100

REF	OEM
REC663-W0078-01	663-W0078-01

55B (1992-18)  
55BET

**new**

REF	OEM
REC6N6-W0078-02	6N6-W0078-00

115B/BE/BET/CETO/TRX/CETO  
130BET/TLR

REF	OEM
REC6K5-W0078-01	6K5-W0078-01

E60HM  
E-60H

REF	OEM
REC68V-W0078-00	68V-W0078-00

F115  
FL115  
LF115

REF	OEM
REC6H3-W0078-02	6H3-W0078-00

60FE/FET/FEO/FETO  
70AETN/B/BEH/BE0/CE

REF	OEM
REC65N-W0078-A1	65N-W0078-A1

D150H/N/NETOL

REF	OEM
REC692-W0078-02	692-W0078-02

60TR/FETO  
75AED/AET  
75CETO/TLR/E75B  
70BETO/TR  
80A  
85A/AE/AED/AET/AEM  
90A/AETO/AEMO/TLR  
C90TRZ

REF	OEM
REC6G5-W0078-A1	6G5-W0078-00 6G5-W0078-01 6G5-W0078-A1

150A/C/E (1984-91)  
175A/B (1984-91)  
200A/E/B (1984-91)  
225A/B (1987-91)

**new**

**new**

REF	OEM
REC6P2-W0078-00	6P2-W0078-00

F225C/T (2008-15)  
F250B/T/A (2009+)

**new**

REF	OEM
REC6CE-W0078-01	6CE-W0078-01 6CE-W0078-00

F300A/B/C (2001+) V6  
F250 C/D (2001+) V6  
F225 C/F/L (2011+) V6

REF	OEM
REC61A-W0078-A1	61A-W0078-01

250ETD/AET/AET  
150FETO  
175FETO  
200FETO

**new**

REF	OEM
REC6AW-W0078-00	6AW-W0078-00

F300A/T (2008-11) V8  
F350A/C/T (2008+) V8

REF	OEM
REC60X-W0078-00	60X-W0078-00

Z250FETO  
V250TLR  
Z300BETO  
V300TLR

GUÍA KITS DE BOMBA DE AGUA		GUIDE OF WATER PUMP SERVICE KITS		GUIDA KIT POMPA ACQUA		GUIDE KITS POMPES À EAU			
REF	OEM	REF	OEM	REF	OEM	REF	OEM		
4AC/AS	1985-96	REC6E0-W0078-A2	6E0-W0078-A2, -00,-01,-02	F30	6BT1 - 6BT9	2009-16	REC6BG-W0078-00	6BG-W0078-00	
5C/CS	1985-96			F40	6BG1 - 6BG9	2009-16			
F9.9	6CA1 - 6AC9	REC6AH-W0078-00	6AH-W0078-00	F40	6CY1 - 6CY7	2011-16	REC6CJ-W0078-00	6CJ-W0078-00	
F13.5	6AF1 - 6AF3			2007-09	F70	6CJ1 - 6CJ7			2011-16
F15	6AG1 - 6AG9			2007-14	F225	6CL1 - 6CL4	2011-13	REC6CE-W0078-01	6CE-W0078-00,-01
F15	6AGA - 6AGB			2015-16	F225	6CM1 - 6CM4	2011-13		
F20	6AH1 - 6AH9			2007-14	F250	6CG1 - 6CG4	2011-13		
F20	6AHA - 6AHB			2015-16	F250	6CH1 - 6CH4	2011-13		
F300	6BK1 - 6BK4	2008-11	F300	6CE1 - 6CE4	2011-13				
F300	6BJ1 - 6BJ4	2008-11	F300	6CF1 - 6CF4	2011-13				
F350	6AW1 - 6AW9	2008-15	REC6AW-W0078-00	6AW-W0078-00					
F350	6AX1 - 6AX9	2008-15							

**GUÍA BOMBAS DE AGUA**

**GUIDE WATER PUMP**

**GUIDA POMPA ACQUA**

**GUIDE POMPE À EAU**

		1	2	3	4	5	6	7	KIT	
F2.5	69F0 > 69F3 60N1 > 60N5	2003	REC6L5-44352-00	PAF2.6-03000015	PAF2.6-03000010	PAF2.6-03000014	PAJASOF404-19-033	PAF4-03000021	PAF2.6-03000013	
F4	68R > 68R3 60P1 > 60P2	2002-09	REC6E0-44352-00	REC6E0-44322-02	PAF4-03000015	PAF4-03000019	PAF4-03000018	PAF4-03000021	PAF4-03000016	
F5		2010	REC6E0-44352-00	PAF6-03000002		PAF6-03000001		PAF4-03000021	PAF4-03000016	
F6B, BMH, A, AM, AW, ML, MH	6J6 > 6J7	2001-09	REC68T-44352-00	REC63V-44322-00	REC68T-44323-00	REC63V-44301-00	REC93210-44398	REC68T-44366-00	REC664-44338-00	REC68T-W0078-00
F6A, ML, MS, AM, BM	60R1 > 60R9 68T > 68T3 60RA > 60RB 6FW1	2000-06	REC68T-44352-00	REC63V-44322-00	REC68T-44323-00	REC63V-44301-00	REC93210-44398	REC68T-44366-00	REC664-44338-00	REC68T-W0078-00
F6 (1cyl)		2010	REC6E0-44352-00	PAF6-03000002		PAF6-03000001	PAF4-03000018	PAF4-03000021	PAF4-03000016	
F8AM, B, BE, BM	6G8	1986-95	REC682-44352-01	REC682-44322-00	REC682-44323-40		REC682-44315-00	REC682-44365-00	REC90280-03024	REC682-W0078-A1
F8C, ML, CM, MS, MH, ML, FM	6G9	2000-15	REC68T-44352-00	REC63V-44322-00	REC68T-44323-00	REC63V-44301-00	REC93210-44398	REC68T-44366-00	REC664-44338-00	REC68T-W0078-00
T8		2001-10	REC63V-44352-01	REC63V-44322-00	REC68T-44323-00	REC63V-44301-00	REC93210-44398	REC68T-44366-00	REC664-44338-00	
F9.9A, AE, AM	66N>66N8	1985-96	REC682-44352-01	REC682-44322-00	REC682-44323-40		REC682-44315-00	REC682-44365-00	REC90280-03024	REC682-W0078-A1
F9.9B, BE, BM	6AU1>6AU6 6DR1>6DR3	1985-96	REC682-44352-01	REC682-44322-00	REC682-44323-40		REC682-44315-00	REC682-44365-00	REC90280-03024	REC682-W0078-A1
F9.9	66R>66R8	1985-04	REC682-44352-01	REC682-44322-00	REC682-44323-40		REC682-44315-00	REC682-44365-00	REC90280-03024	REC682-W0078-A1
F9.9C, CE, CM, CW, MH	69C>69C1	1998-08	REC63V-44352-01	REC63V-44322-00	REC63V-44323-00	REC63V-44301-00	REC93210-44398	REC647-44366-00	REC664-44338-00	REC63V-W0078-01
F9.9F, FE, FM, MH, ML, JE, JM		2008-15	REC63V-44352-01	REC63V-44322-00	REC68T-44323-00	REC63V-44301-00	REC93210-44398	REC68T-44366-00	REC664-44338-00	REC68T-W0078-00
F9.9D, DE, DM, DW		1999-08	REC63V-44352-01	REC63V-44322-00	REC63V-44323-00	REC63V-44301-00	REC93210-44398	REC647-44366-00	REC664-44338-00	REC63V-W0078-01
F9.9D, DEP, PLR, TR	6CA1>6CA8	2000-02	REC63V-44352-01	REC63V-44322-00	REC63V-44323-00	REC63V-44301-00	REC93210-44398	REC647-44366-00	REC664-44338-00	REC63V-W0078-01
T9.9	69V2>69V8	1991-99	REC682-44352-01	REC682-44322-00	REC682-44323-40		REC682-44315-00	REC682-44365-00	REC90280-03024	REC682-W0078-A1
F9.9HE, HMH	6P71>6P74	2009-15	REC63V-44352-01	REC63V-44322-00				PAF25-04050004	REC664-44338-00	REC6AH-W0078-00
T9.9	6AF1>6AF3	2005-06	REC63V-44352-01	REC63V-44322-00	REC63V-44323-00	REC63V-44301-00	REC93210-44398	REC647-44366-00	REC664-44338-00	REC63V-W0078-01
F13.5AE, AM	66M>66M7	2002-07	REC63V-44352-01	REC63V-44322-00	REC63V-44323-00	REC63V-44301-00	REC93210-44398	REC647-44366-00	REC664-44338-00	REC63V-W0078-01
F13.5AEP		2005-07	REC63V-44352-01	REC63V-44322-00	REC63V-44323-00	REC63V-44301-00	REC93210-44398	REC647-44366-00	REC664-44338-00	REC63V-W0078-01
F13.5B, BMH	6AG1>6AG9 6AGA	2007-09	REC63V-44352-01	REC63V-44322-00				PAF25-04050004	REC664-44338-00	REC6AH-W0078-00
F15A, AE, AM, EL, MH	65P1>65P5	1998-07	REC63V-44352-01	REC63V-44322-00	REC63V-44323-00	REC63V-44301-00	REC93210-44398	REC647-44366-00	REC664-44338-00	REC63V-W0078-01
F15	6DN1>6DN6	2006-11	REC63V-44352-01	REC63V-44322-00	REC68T-44323-00		REC93210-49046	PAF25-04050004	REC664-44338-00	
F15CE, CM, CW, EL, MH	6AH1>6AH9 6AHA	2007-15	REC63V-44352-01	REC63V-44322-00				PAF25-04050004	REC664-44338-00	REC6AH-W0078-00
F20AE	65W>65W9	2003-06	REC6H4-44352-02	REC61N-44322-00	REC61N-44323-00	PAF25-04050001	PAF25-04050003	PAF25-04050004	REC90280-03024	REC61N-W0078-11
F20DET	68P1>68P8	2011-15	REC6H4-44352-02	REC61N-44322-00	REC61N-44323-00	PAF25-04050001	PAF25-04050003	PAF25-04050004	REC90280-03024	REC61N-W0078-11
F20B, BE, BM, BW, EL, MH		2007-15	REC63V-44352-01	REC63V-44322-00				PAF25-04050004	REC664-44338-00	REC6AH-W0078-00
F25A, AE, AM, AW, EL, MH		1998-09	REC6H4-44352-02	REC61N-44322-00	REC61N-44323-00	PAF25-04050001	PAF25-04050003	PAF25-04050004	REC90280-03024	REC61N-W0078-11
F25DE, DM, MH	6BT1>6BT8	2009-215	REC6H4-44352-02	REC61N-44322-00	REC61N-44323-00	PAF25-04050001	PAF25-04050003	PAF25-04050004	REC90280-03024	REC61N-W0078-11
T25	66W>66W1	2001-06, 2009	REC6H4-44352-02	REC63D-44322-00	REC66T-44323-00		REC93210-59MG7	REC90280-03M03	REC66T-W0078-00	
F30	60K1	2001-05	REC6H4-44352-02	REC63D-44322-00	REC66T-44323-00		REC93210-59MG7	REC90280-03M03	REC66T-W0078-00	
F30BE		2009-15	REC6H4-44352-02	REC63D-44322-00	REC63D-44323-00		REC93210-59MG7	REC663-44366-00	REC90280-03M03	REC6B8-W0078-00
F40 A, ELH	6BG1>6BG8	1999-02	REC6H3-44352-00	REC63D-44322-00	REC63D-44323-00		REC93210-59MG7	REC90280-03024	REC63D-W0078-01	
F40 CET	6AK1>6AK9 6AKA>6AKB	2002	REC6H3-44352-00	REC63D-44322-00	REC63D-44323-00		REC93210-59MG7	REC90280-03024	REC63D-W0078-01	
F40	6CY1>6CY6	2000-08	REC6H4-44352-02	REC63D-44322-00	REC66T-44323-00		REC93210-59MG7	REC90280-03M03	REC66T-W0078-00	
F40FE	62Y	2009-15	REC6H4-44352-02	REC63D-44322-00	REC63D-44323-00		REC93210-59MG7	REC663-44366-00	REC90280-03M03	REC6B8-W0078-00
F40D, DE, HE	62Y	2006-15	REC6H3-44352-00	REC63D-44322-00	REC63D-44323-00		REC93210-59MG7	REC663-44366-00	REC90280-03024	REC63D-W0078-01
F40GET	62Y>62Y6	2011-15	REC6H3-44352-00 REC63D-44322-00					REC663-44366-00	REC90280-03M03	REC6CJ-W0078-00
F45 AET	60A3 60AA	1999	REC6H4-44352-02	REC61N-44322-00	REC61N-44323-00	PAF25-04050001	PAF25-04050003	PAF25-04050004	REC90280-03024	REC61N-W0078-11
F50TJR	6C11>6C19	2003	REC6H4-44352-02	REC61N-44322-00	REC61N-44323-00	PAF25-04050001	PAF25-04050003	PAF25-04050004	REC90280-03024	REC61N-W0078-11
F50 A, AE, TJ, TL	6C1A>6C1C	1997-07	REC6H3-44352-00	REC63D-44322-00	REC63D-44323-00		REC93210-59MG7	REC663-44366-00	REC90280-03024	REC63D-W0078-01
F50 DETL	64J	1995-10	REC6H3-44352-00	REC63D-44322-00	REC63D-44323-00		REC93210-59MG7	REC663-44366-00	REC90280-03024	REC63D-W0078-01
F50F, FE, TR, TL		2005-12	REC6H3-44352-00	REC63D-44322-00	REC63D-44323-00		REC93210-59MG7	REC663-44366-00	REC90280-03024	REC63D-W0078-01
F50 HED	69W1>69W6	2013-15	REC6H3-44352-00	REC63D-44322-00	REC63D-44323-00		REC93210-59MG7	REC663-44366-00	REC90280-03024	REC63D-W0078-01
F50B, T50TLR	6C51>6C59	1997-99	REC6H3-44352-00	REC63D-44322-00	REC63D-44323-00		REC93210-59MG7	REC663-44366-00	REC90280-03024	REC63D-W0078-01
T50	6C5A>6C5C	1996	REC6H3-44352-00	REC663-44322-00	REC6H3-44323-00		REC6H3-44315-00	REC90280-03024	REC6H3-W0078-02	
F60 AE, TL, TJ		2002-07	REC6H3-44352-00	REC63D-44322-00	REC63D-44323-00		REC6H3-44315-00	REC663-44366-00	REC90280-03M03	REC63D-W0078-01
F60 A, C, CET, TR, TJR	6CJ1>6CJ6	2005-12	REC6H3-44352-00	REC63D-44322-00	REC63D-44323-00		REC6H3-44315-00	REC663-44366-00	REC90280-03M03	REC63D-W0078-01
F60 B, FET	6D61	2013-15	REC6H3-44352-00	REC63D-44322-00	REC63D-44323-00		REC6H3-44315-00	REC663-44366-00	REC90280-03M03	REC63D-W0078-01
T60	67G0>67G5	2003-11	REC6H3-44352-00	REC663-44322-00	REC6H3-44323-00		REC6H3-44315-00	REC90280-03M03	REC6H3-W0078-02	
F70A, AET	6D71>6D79 6D7A>6D7C	2011-15	REC6H3-44352-00 REC63D-44322-00					REC663-44366-00	REC90280-03M03	REC6CJ-W0078-00
F75BET, TR, TLR		2005	REC67F-44352-00	REC67F-44322-00	REC67F-44323-00	REC67F-44311-01	REC688-44315-00	REC90280-04M04	REC67F-W0078-00	
F80A, AET, TLR, TJR	67F>67F5	1999-03	REC67F-44352-00	REC67F-44322-00	REC67F-44323-00	REC67F-44311-01	REC688-44315-00	REC90280-04M04	REC67F-W0078-00	
F80B, BET	6D91>6D99 6D9A>6D9C	2005-15	REC67F-44352-00	REC67F-44322-00	REC67F-44323-00	REC67F-44311-01	REC688-44315-00	REC90280-04M04	REC67F-W0078-00	
F90	68V, 68V0, 68W0	2003-11	REC67F-44352-00	REC67F-44322-00	REC67F-44323-00	REC67F-44311-01	REC688-44315-00	REC90280-04M04	REC67F-W0078-00	
F100A, AET, TLR, TRZ		1999-06	REC67F-44352-00	REC67F-44322-00	REC67F-44323-00	REC67F-44311-01	REC688-44315-00	REC90280-04M04	REC67F-W0078-00	

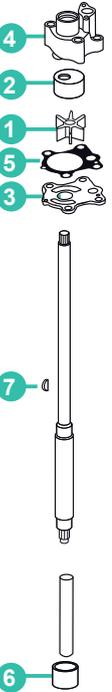

			1	2	3	4	5	6	7	KIT
F100DET	68V, 68VO, 68W	2005-15	REC67F-44352-00	REC67F-44322-00	REC67F-44323-00	REC67F-44311-01	REC688-44315-00		REC90280-04M04	REC67F-W0078-00
F115A (68V/68VO)		2000-01	REC6E5-44352-01	REC61A-44322-02	REC6E5-44323-00-40	REC6E5-44311-00	REC93210-86M38	REC6E5-44366-00	REC90280-04M05	REC6N6-W0078-02
F115TLR (68V)	68V1>68V9 68VA>68VF	2000	REC6E5-44352-01	REC61A-44322-02	REC6E5-44323-00-40	REC6E5-44311-00	REC93210-86M38	REC6E5-44366-00	REC90280-04M05	REC6N6-W0078-02
F115TLR/ TRZ/ TXR	68W1>68W9 68WA>68WF	2000-01	REC6E5-44352-01	REC61A-44322-02	REC6E5-44323-00-40	REC6E5-44311-00	REC93210-86M38	REC6E5-44366-00	REC90280-04M05	REC6N6-W0078-02
LF115TXR (68W/68WO)	6EK1>6EK2 6EL1>6EL2	2000-01	REC6E5-44352-01	REC61A-44322-02	REC6E5-44323-00-40	REC6E5-44311-00	REC93210-86M38	REC6E5-44366-00	REC90280-04M05	REC6N6-W0078-02
F115A, AET, TJR6EM1		2002-15	REC6E5-44352-01	REC61A-44322-02	REC68V-44323-00	REC61A-44311-00	REC93210-86M38	REC6E5-44365-00	REC90280-04M05	REC68V-W0078-00
LF/FL115A, AET, TX, TR, B, BET		2002-15	REC6E5-44352-01	REC61A-44322-02	REC68V-44323-00	REC61A-44311-00	REC93210-86M38	REC6E5-44365-00	REC90280-04M05	REC68V-W0078-00
FL/FL115B, BET		2014-15	REC6E5-44352-01	REC61A-44322-02	REC68V-44323-00	REC61A-44311-00	REC93210-86M38	REC6E5-44365-00	REC90280-04M05	REC68V-W0078-00
F130A, AET		2015	REC6E5-44352-01	REC61A-44322-02	REC68V-44323-00	REC61A-44311-00	REC93210-86M38	REC6E5-44365-00	REC90280-04M05	REC68V-W0078-00
F150/FL150		2004-12	REC6E5-44352-01	REC61A-44322-02	REC6G5-44323-00	REC61A-44311-00	REC93210-86M38	REC6E5-44365-00	REC90280-04M05	REC61A-W0078-A1
F200/FL200		2002-11	REC6E5-44352-01	REC61A-44322-02	REC6G5-44323-00	REC61A-44311-00	REC93210-86M38	REC6E5-44365-00	REC90280-04M05	REC61A-W0078-A1
VF200	6BB2>6BB9	2009-11	REC6E5-44352-01	REC61A-44322-02		REC61A-44311-00	REC93210-86M38	REC6E5-44365-00		
F225/FL225	6CL1>6CL4 6CM1>6CM4	2002-10	REC6E5-44352-01	REC61A-44322-02	REC6G5-44323-00	REC61A-44311-00	REC93210-86M38	REC6E5-44365-00	REC90280-04M05	REC61A-W0078-A1
F225/FL225		2007-09 (20")	REC6E5-44352-01	REC61A-44322-02	REC6P2-44323-00	REC61A-44311-00	REC93210-86M38	REC6E5-44365-00	REC90280-04M05	REC6P2-W0078-00
F225CET		2009-15	REC6E5-44352-01	REC61A-44322-02	REC6P2-44323-00	REC61A-44311-00	REC93210-86M38	REC6E5-44365-00	REC90280-04M05	REC6P2-W0078-00
LF/FL/F225CA, FET	6BR1>6BR3 6BS1>6BS3	2011-13	REC6CE-44352-00							
VF225	6P2A 6P23>6P29	2009-11	REC6E5-44352-01	REC61A-44322-02		REC61A-44311-00	REC93210-86M38	REC6E5-44365-00		
F250/FL250	6P33>6P39	2005	REC6E5-44352-01	REC61A-44322-02	REC6G5-44323-00	REC61A-44311-00	REC93210-86M38	REC6E5-44365-00	REC90280-04M05	REC61A-W0078-A1
FL/F250BET	6CG1>6CG4 6CH1>6CH4	2001-11	REC6E5-44352-01	REC61A-44322-02	REC6P2-44323-00	REC61A-44311-00	REC93210-86M38	REC6E5-44365-00	REC90280-04M05	REC6P2-W0078-00
F250A, AET, TR, TUR		2007-13	REC6E5-44352-01	REC61A-44322-02	REC6P2-44323-00	REC61A-44311-00	REC93210-86M38	REC6E5-44365-00	REC90280-04M05	REC6P2-W0078-00
LF/FL/F250A, AET, TR, TX	6CF1>6CF4 6CF1>6CF4	2007-12	REC6E5-44352-01	REC61A-44322-02	REC6P2-44323-00	REC61A-44311-00	REC93210-86M38	REC6E5-44365-00	REC90280-04M05	REC6P2-W0078-00
LF/FL/F250CA, DET	6B11>6B14 6BK1>6BK4	2011-13	REC6CE-44352-00							
VF250	6AW1>6AW9	2009-10	REC6E5-44352-01	REC61A-44322-02		REC61A-44311-00	REC93210-86M38	REC6E5-44365-00	REC90280-04M05	
F300/FL-300BET, CA	6AX1>6AX9	2011-13	REC6CE-44352-00							
F300/FL300AET		2008-11	CEF500389N							REC6AW-W0078-00
F350AET, CB, TRG, TUR		2008-15	CEF500389N							REC6AW-W0078-00
LF/FL350AET, CB, TRG, TUR		2008-15	CEF500389N							REC6AW-W0078-00

2T STROKES

GUÍA BOMBAS DE AGUA			GUIDE WATER PUMP			GUIDA POMPA ACQUA			GUIDE POMPE À EAU		
			1	2	3	4	5	6	7	KIT	
2B	6A1	1985-99			REC646-44323-00					REC6A1-W0078-01	
2B, MSHA	6A11>6A12 6F89	2002-10	REC646-44352-01		REC646-44323-00						
4AC, AS	6E0>6E1	1985-96	REC6E0-44352-00	REC6E0-44322-02	PAF4-03000015			PAF4-03000021		REC6E0-W0078-A2	
5C, CS	6E3>6E4	1985-96	REC6E0-44352-00	REC6E0-44322-02	PAF4-03000015			PAF4-03000021		REC6E0-W0078-A2	
6 D /DEM	6H8	1984-96	REC6G1-44352-00	REC6G1-44322-02	REC6G1-44323-00		REC6G1-44315-A0	REC647-44366-00	REC90280-03024	REC6G1-W0078-A1	
6 J / C / CEM	6H6	1984-96	REC6G1-44352-00	REC6G1-44322-02	REC6G1-44323-00		REC6G1-44315-A0	REC647-44366-00	REC90280-03024	REC6G1-W0078-A1	
8 N / J / C / CEM	6G1	1984-96	REC6G1-44352-00	REC6G1-44322-02	REC6G1-44323-00		REC6G1-44315-A0	REC647-44366-00	REC90280-03024	REC6G1-W0078-A1	
9.9D	6,00E+007	1984-95	REC682-44352-01	REC682-44322-00	REC682-44323-40		REC682-44315-00	REC682-44365-00	REC90280-03024	REC682-W0078-A1	
9.9F, FEM, FM, MH, MS	63V	1995-00	REC63V-44352-01	REC63V-44322-00	REC63V-44323-00	REC63V-44301-00	REC93210-44398	REC647-44366-00	REC664-44338-00	REC63V-W0078-01	
13.5AWH	63V	1998	REC63V-44352-01	REC63V-44322-00	REC63V-44323-00	REC63V-44301-00	REC93210-44398	REC647-44366-00	REC664-44338-00	REC63V-W0078-01	
15D	6,00E+008	1984-95	REC682-44352-01	REC682-44322-00	REC682-44323-40		REC682-44315-00	REC682-44365-00	REC90280-03024	REC682-W0078-A1	
15F, FEM, MH, MS	63W	1995-00	REC63V-44352-01	REC63V-44322-00	REC63V-44323-00	REC63V-44301-00	REC93210-44398	REC647-44366-00	REC664-44338-00	REC63V-W0078-01	
20D, DE, DM, MLH, MSH, DW	6L3>6L39	1998-11	REC6L2-44352-00	REC6L2-44322-00			REC93210-45161	PAF25-04050004	PAF25-04000015	REC6L2-W0078-00	
20C	6A9 / 6A90 / 6A91	1997-02	REC689-44352-02	REC689-W4432-01	REC689-44323-00	REC689-44311-00	REC689-44324-A0	REC689-44366-00	REC664-44338-00	REC689-W0078-A6	
20CM	6A9	1992	REC689-44352-02	REC689-W4432-01	REC689-44323-00	REC689-44311-00	REC689-44324-A0	REC689-44366-00	REC664-44338-00	REC689-W0078-A6	
25D	6950	2001	REC689-44352-02	REC689-W4432-01	REC689-44323-00	REC689-44311-00	REC689-44324-A0	REC689-44366-00	REC664-44338-00	REC689-W0078-A6	
25		1984-85	REC689-44352-02	REC689-W4432-01	REC689-44323-00	REC689-44311-00	REC689-44324-A0	REC689-44366-00	REC664-44338-00	REC689-W0078-04	
25D, N, NE, MLH, MSH, NMH	6L2>6L29	1998-10	REC6L2-44352-00	REC6L2-44322-00			REC93210-45161	PAF25-04050004	PAF25-04000015	REC6L2-W0078-00	
25NMH, NW, MH	6L2A>6L2F	2011-15	REC6L2-44352-00	REC6L2-44322-00			REC93210-45161	PAF25-04050004	PAF25-04000015	REC6L2-W0078-00	
25 J, JEO	6K9	1987-94	REC6H4-44352-02	REC663-44322-00	REC663-44323-00	REC663-44311-02	REC663-44315-A0	REC663-44366-00	REC90280-03024	REC6J8-W0078-A2	
C25		1990-97	REC689-44352-02	REC689-W4432-01	REC689-44323-00	REC689-44311-00	REC689-44324-A0	REC689-44366-00	REC664-44338-00	REC689-W0078-A6	
CV25		1990	REC689-44352-02	REC689-W4432-01	REC689-44323-00	REC689-44311-00	REC689-44324-A0	REC689-44366-00	REC664-44338-00	REC689-W0078-A6	
30		1984-85	REC689-44352-02	REC689-W4432-01	REC689-44323-00	REC689-44311-00	REC689-44324-A0	REC689-44366-00	REC664-44338-00	REC689-W0078-04	
30		1986	REC689-44352-02	REC689-W4432-01	REC689-44323-00	REC689-44311-00	REC689-44324-A0	REC689-44366-00	REC664-44338-00	REC689-W0078-A6	
30D		1986-94	REC6H4-44352-02	REC663-44322-00	REC663-44323-00	REC663-44311-02	REC663-44315-A0	REC663-44366-00	REC90280-03024	REC682-W0078-A1	
30D, DE, DMH	6J8	1986-94	REC6H4-44352-02	REC663-44322-00	REC663-44323-00	REC663-44311-02	REC663-44315-A0	REC663-44366-00	REC90280-03024	REC6J8-W0078-A2	
C30		1990-92	REC689-44352-02	REC689-W4432-01	REC689-44323-00	REC689-44311-00	REC689-44324-A0	REC689-44366-00	REC664-44338-00	REC689-W0078-A6	
C30		1993-97	REC6H4-44352-02	REC61N-44322-00	REC61N-44323-00	PAF25-04050001	PAF25-04050003	PAF25-04050004	REC90280-03024	REC61N-W0078-11	
40		1984-87	REC6H4-44352-02	REC663-44322-00	REC663-44323-00	REC663-44311-02	REC663-44315-A0	REC663-44366-00	REC90280-03024	REC6H4-W0078-00	
40		1988-94	REC6H4-44352-02	REC663-44322-00	REC663-44323-00		REC663-44315-A0	REC663-44366-00	REC90280-03024	REC6H4-W0078-00	

			1	2	3	4	5	6	7	KIT
40	1995-05	REC6H3-44352-00	REC63D-44322-00	REC63D-44323-00	REC63D-44311-01	REC93210-59MG7	REC663-44366-00	REC90280-03024	REC63D-W0078-01	
E40GMH	6F62 2003	REC6F5-44352-00	REC676-44322-00	REC676-44323-00-40	REC676-44311-00	REC676-44315-00	REC663-44366-00	REC90280-04M00	REC6F5-W0078-A0	
40GWH	6F62 2003	REC6F5-44352-00	REC676-44322-00	REC676-44323-00-40	REC676-44311-00	REC676-44315-00	REC663-44366-00	REC90280-04M00	REC6F5-W0078-A0	
C40	1990-91	REC6F5-44352-00	REC676-44322-00	REC676-44323-00-40	REC676-44311-00	REC676-44315-00	REC663-44366-00	REC90280-04M00	REC6F5-W0078-A0	
C40	1992-97	REC6F5-44352-00	REC676-44322-00	REC676-44323-00-40	REC676-44311-00	REC676-44315-00	REC663-44366-00	REC90280-04M00	REC679-W0078-A1	
40QE	6R6 1990	REC6F5-44352-00	REC676-44322-00	REC676-44323-00-40	REC676-44311-00	REC676-44315-00	REC663-44366-00	REC90280-04M00	REC679-W0078-A1	
EK40JMH	6H95 2006	REC6F5-44352-00	REC676-44322-00	REC676-44323-00-40	REC676-44311-00	REC676-44315-00	REC663-44366-00	REC90280-04M00	REC679-W0078-A1	
C40MLH	63B>63B2 2000-03	REC6H3-44352-00	REC63D-44322-00	REC63D-44323-00	REC63D-44311-01	REC93210-59MG7	REC663-44366-00	REC90280-03024	REC63D-W0078-01	
C40T, TLRZ	63D>63D6 1996-03	REC6H3-44352-00	REC63D-44322-00	REC63D-44323-00	REC63D-44311-01	REC93210-59MG7	REC663-44366-00	REC90280-03024	REC63D-W0078-01	
P40	1998	REC6H3-44352-00	REC63D-44322-00	REC63D-44323-00	REC63D-44311-01	REC93210-59MG7	REC663-44366-00	REC90280-03024	REC63D-W0078-01	
40V, VE	63D>63D6 1996-03	REC6H3-44352-00	REC63D-44322-00	REC63D-44323-00	REC63D-44311-01	REC93210-59MG7	REC663-44366-00	REC90280-03024	REC63D-W0078-01	
40V, VE, VEO, VES	63C>63C9 63CA>63CF 1997-15	REC6H3-44352-00	REC63D-44322-00	REC63D-44323-00	REC63D-44311-01	REC93210-59MG7	REC663-44366-00	REC90280-03024	REC63D-W0078-01	
40V, VMH	63B>63BF 1995-15	REC6H3-44352-00	REC63D-44322-00	REC63D-44323-00	REC63D-44311-01	REC93210-59MG7	REC663-44366-00	REC90280-03024	REC63D-W0078-01	
50	1984-87	REC6H4-44352-02	REC663-44322-00	REC663-44323-00	REC663-44311-02	REC663-44315-A0	REC663-44366-00	REC90280-03024	REC6H4-W0078-00	
50	1988-94	REC6H4-44352-02	REC663-44322-00	REC663-44323-00	REC663-44311-02	REC663-44315-A0	REC663-44366-00	REC90280-03024	REC6H4-W0078-00	
50HMD0, H	62W,63G 1995-00	REC6H3-44352-00	REC63D-44322-00	REC63D-44323-00	REC63D-44311-01	REC93210-59MG7	REC663-44366-00	REC90280-03024	REC63D-W0078-01	
50H, HEM, HWH/ CS0TLR	62X>62X5 2000-03	REC6H3-44352-00	REC63D-44322-00	REC63D-44323-00	REC63D-44311-01	REC93210-59MG7	REC663-44366-00	REC90280-03024	REC63D-W0078-01	
C50	1998-01	REC6H3-44352-00	REC63D-44322-00	REC63D-44323-00	REC63D-44311-01	REC93210-59MG7	REC663-44366-00	REC90280-03024	REC63D-W0078-01	
PRO 50	1987	REC6H4-44352-02	REC663-44322-00	REC663-44323-00	REC663-44311-02	REC663-44315-A0	REC663-44366-00	REC90280-03024	REC6H4-W0078-00	
PRO 50	1988-90	REC6H4-44352-02	REC663-44322-00	REC663-44323-00	REC663-44311-02	REC663-44315-A0	REC663-44366-00	REC90280-03024	REC6H4-W0078-00	
P50	1991-93	REC6H4-44352-02	REC663-44322-00	REC663-44323-00	REC663-44311-02	REC663-44315-A0	REC663-44366-00	REC90280-03024	REC6H4-W0078-00	
P50	1995-96	REC6H3-44352-00	REC689-W4432-01	REC63D-44323-00	REC63D-44311-01	REC93210-59MG7	REC663-44366-00	REC90280-03024	REC63D-W0078-01	
55B, BET, BM	697 1992-00	REC6H3-44352-00	REC663-44322-00	REC663-44323-00	REC663-44311-02	REC663-44315-A0	REC663-44366-00	REC90280-03M03	REC663-W0078-01	
55B, BET, BM	6970>6971 1989	REC6H3-44352-00	REC663-44322-00	REC663-44323-00	REC663-44311-02	REC663-44315-A0	REC663-44366-00	REC90280-03M03	REC663-W0078-01	
60	2001-03	REC6H3-44352-00	REC663-44322-00	REC6H3-44323-00	REC6H3-44315-00	REC663-44366-00	REC90280-03M03	REC6H3-W0078-02		
60	2004-05	REC688-44352-03	REC688-44322-00	REC688-44323-00	REC688-44311-01	REC688-44315-00	REC663-44366-00	REC90280-04M04	REC692-W0078-02	
C60	1996-01	REC6H3-44352-00	REC663-44322-00	REC6H3-44323-00	REC6H3-44315-00	REC663-44366-00	REC90280-03M03	REC6H3-W0078-02		
E60	1995-96	REC6H3-44352-00	REC663-44322-00	REC6H3-44323-00	REC6H3-44315-00	REC663-44366-00	REC90280-03M03	REC6H3-W0078-02		
E-60H/ E60HMH	6K5 1997-00	REC6H3-44352-00	REC663-44322-00	REC6H3-44323-00	REC6H3-44315-00	REC663-44366-00	REC90280-03M03	REC6K5-W0078-01		
P60	1991	REC6H3-44352-00	REC663-44322-00	REC6H3-44323-00	REC6H3-44315-00	REC663-44366-00	REC90280-03M03	REC6H3-W0078-02		
P60	1992-99	REC6H3-44352-00	REC663-44322-00	REC6H3-44323-00	REC6H3-44315-00	REC663-44366-00	REC90280-03M03	REC6H3-W0078-02		
70	1984-03	REC6H3-44352-00	REC663-44322-00	REC6H3-44323-00	REC6H3-44315-00	REC663-44366-00	REC90280-03M03	REC6H3-W0078-02		
70	2004-09	REC688-44352-03	REC688-44322-00	REC688-44323-00	REC688-44311-01	REC688-44315-00	REC663-44366-00	REC90280-04M04	REC692-W0078-02	
C70	2000-01	REC6H3-44352-00	REC663-44322-00	REC6H3-44323-00	REC6H3-44315-00	REC663-44366-00	REC90280-03M03	REC6H3-W0078-02		
C75	1994-99	REC688-44352-03	REC688-44322-00	REC688-44323-00	REC688-44311-01	REC688-44315-00	REC663-44366-00	REC90280-04M04	REC692-W0078-02	
E75	1995-00	REC688-44352-03	REC688-44322-00	REC688-44323-00	REC688-44311-01	REC688-44315-00	REC663-44366-00	REC90280-04M04	REC692-W0078-02	
P75	1996-99	REC688-44352-03	REC688-44322-00	REC688-44323-00	REC688-44311-01	REC688-44315-00	REC663-44366-00	REC90280-04M04	REC692-W0078-02	
75CETO, TLR	67P1>67P9 2003-2011	REC688-44352-03	REC688-44322-00	REC688-44323-00	REC688-44311-01	REC688-44315-00	REC663-44366-00	REC90280-04M04	REC692-W0078-02	
75CETO	67PA>67PE 2012-15	REC688-44352-03	REC688-44322-00	REC688-44323-00	REC688-44311-01	REC688-44315-00	REC663-44366-00	REC90280-04M04	REC692-W0078-02	
75A, AE	692>692B 692A>692C 1997-07	REC688-44352-03	REC688-44322-00	REC688-44323-00	REC688-44311-01	REC688-44315-00	REC663-44366-00	REC90280-04M04	REC692-W0078-02	
80A, AEO, AEM	6H0>6H01 1997-02	REC688-44352-03	REC688-44322-00	REC688-44323-00	REC688-44311-01	REC688-44315-00	REC663-44366-00	REC90280-04M04	REC692-W0078-02	
C80	1997	REC688-44352-03	REC688-44322-00	REC688-44323-00	REC688-44311-01	REC688-44315-00	REC663-44366-00	REC90280-04M04	REC692-W0078-02	
85A, AED, AET	688>6882 1997-03	REC688-44352-03	REC688-44322-00	REC688-44323-00	REC688-44311-01	REC688-44315-00	REC663-44366-00	REC90280-04M04	REC692-W0078-02	
85A	688 1990	REC682-44352-01	REC682-44322-00	REC682-44323-00	REC682-44315-00	REC682-44315-00	REC682-44365-00	REC90280-03024	REC682-W0078-A1	
C85	1989-97	REC688-44352-03	REC688-44322-00	REC688-44323-00	REC688-44311-01	REC688-44315-00	REC663-44366-00	REC90280-04M04	REC692-W0078-02	
CV85	1989-91	REC688-44352-03	REC688-44322-00	REC688-44323-00	REC688-44311-01	REC688-44315-00	REC663-44366-00	REC90280-04M04	REC692-W0078-02	
90AEO	6H1 1992	REC682-44352-01	REC682-44322-00	REC682-44323-00	REC682-44315-00	REC682-44315-00	REC682-44365-00	REC90280-03024	REC682-W0078-A1	
90A, AE, TR, TLR, FE, BET	6H1>6H39 6H1A>6H3F 6H2C>6H2J 1997-15	REC688-44352-03	REC688-44322-00	REC688-44323-00	REC688-44311-01	REC688-44315-00	REC663-44366-00	REC90280-04M04	REC692-W0078-02	
B90	1997-99	REC688-44352-03	REC688-44322-00	REC688-44323-00	REC688-44311-01	REC688-44315-00	REC663-44366-00	REC90280-04M04	REC692-W0078-02	
C90	1997-01	REC688-44352-03	REC688-44322-00	REC688-44323-00	REC688-44311-01	REC688-44315-00	REC663-44366-00	REC90280-04M04	REC692-W0078-02	
100A/ AETO	64W 1996	REC6E5-44352-01	REC61A-44322-02	REC6E5-44323-00-40	REC61A-44311-00	REC6E5-44315-A0	REC6E5-44366-00	REC90280-04M05	REC6N6-W0078-02	
100A/ TLR	64W/ 64W0 1997-01	REC6E5-44352-01	REC6E5-44322-00	REC6E5-44323-00-40	REC6E5-44311-00	REC93210-86M38	REC6E5-44366-00	REC90280-04M05	REC6N6-W0078-02	
115B/ BE	6E5/ 6E50/ 6E51 1998-02	REC6E5-44352-01	REC6E5-44322-00	REC6E5-44323-00-40	REC6E5-44311-00	REC93210-86M38	REC6E5-44366-00	REC90280-04M05	REC6N6-W0078-02	
115B/ BE/ BETO	6,00E+005 1993-96	REC6E5-44352-01	REC61A-44322-02	REC6E5-44323-00-40	REC61A-44311-00	REC6E5-44315-A0	REC6E5-44366-00	REC90280-04M05	REC6N6-W0078-02	
115BE	6E5 1997	REC6E5-44352-01	REC6E5-44322-00	REC6E5-44323-00-40	REC6E5-44311-00	REC93210-86M38	REC6E5-44366-00	REC90280-04M05	REC6N6-W0078-02	
115C	6N6 6N61 2000-02	REC6E5-44352-01	REC6E5-44322-00	REC6E5-44323-00-40	REC6E5-44311-00	REC93210-86M38	REC6E5-44366-00	REC90280-04M05	REC6N6-W0078-02	
115CEO/ CETO	6N6 1993-96	REC6E5-44352-01	REC61A-44322-02	REC6E5-44323-00-40	REC61A-44311-00	REC6E5-44315-A0	REC6E5-44366-00	REC90280-04M05	REC6N6-W0078-02	
115CET/ CETO/ TR/ TLR	6N6-6N69 6N6A-6N6E 1997-13	REC6E5-44352-01	REC6E5-44322-00	REC6E5-44323-00-40	REC6E5-44311-00	REC93210-86M38	REC6E5-44366-00	REC90280-04M05	REC6N6-W0078-02	
115TXRZ	6N60 2001	REC6E5-44352-01	REC6E5-44322-00	REC6E5-44323-00-40	REC6E5-44311-00	REC93210-86M38	REC6E5-44366-00	REC90280-04M05	REC6N6-W0078-02	
C115-115TLR	6N6/6E5 1998-00	REC6E5-44352-01	REC6E5-44322-00	REC6E5-44323-00-40	REC6E5-44311-00	REC93210-86M38	REC6E5-44366-00	REC90280-04M05	REC6N6-W0078-02	
C115	1991-92	REC6E5-44352-01	REC6E5-44322-00	REC6E5-44323-00-40	REC6E5-44311-00	REC93210-86M38	REC6E5-44366-00	REC90280-04M05	REC6N6-W0078-02	
C115	1993-00	REC6E5-44352-01	REC61A-44322-02	REC6E5-44323-00-40	REC61A-44311-00	REC93210-86M38	REC6E5-44366-00	REC90280-04M05	REC6N6-W0078-02	
P115	62A 1993-96	REC6E5-44352-01	REC61A-44322-02	REC6E5-44323-00-40	REC61A-44311-00	REC93210-86M38	REC6E5-44366-00	REC90280-04M05	REC6N6-W0078-02	
115	6N6/6E5 1984-94	REC6E5-44352-01	REC61A-44322-02	REC6E5-44323-00-40	REC6E5-44311-00	REC93210-86M38	REC6E5-44366-00	REC90280-04M05	REC6N6-W0078-02	
130 BETO	6N7/ 6N70/ 6N77 1997-07	REC6E5-44352-01	REC61A-44322-02	REC6E5-44323-00-40	REC6E5-44311-00	REC93210-86M38	REC6E5-44366-00	REC90280-04M05	REC6N6-W0078-02	</





# ÁNODO

# ANODE

# ANODI

# ANODE

YAMAHA

ZN	KG (KG)	AL	KG (KG)	OEM
CM15026	0,01	CM15026A	0,005	6E5-11325-00

100-225 hp



ZN	KG (KG)	OEM
CM6U4-45251-00	0,27	6U4-45251-00

Serie TD



ZN	KG (KG)	AL	KG (KG)	OEM
CM6G5-45251-01	0,91	CM6G5-45251-01A	0,37	6G5-45251-01

MALTA 2/4, 3.5 HP  
2B/3, A/4, A/5C, 150/200 HP



ZN	KG (KG)	AL	KG (KG)	OEM
CM68V-11325-01	0,07	CM68V-11325-01A	0,03	68V-11325-01



ZN	KG (KG)	AL	KG (KG)	OEM
CM68T-45251-00	0,10	CM68T-45251-00A	0,04	68T-45251-00



ZN	KG (KG)	AL	KG (KG)	OEM
CM6E5-45251-00	0,14	CM6E5-45251-00A	0,05	6E5-45251-00



ZN	KG (KG)	AL	KG (KG)	OEM
CM6E0-45251-11	0,10	CM6E0-45251-11A	0,04	6E0-45251-11-00

40 hp



ZN	KG (KG)	AL	KG (KG)	OEM
CM67C-45251-00	0,12	CM67C-45251-00A	0,047	67C-45251-00



ZN	KG (KG)	AL	KG (KG)	OEM
CM3082523	0,03	CM689-11325-00A	0,0069	689-11325-00



ZN	KG (KG)	AL	KG (KG)	OEM
CM6H1-45251-02	0,49	CM6H1-45251-02A	0,20	6H14525102

TOP 700



ZN	KG (KG)	OEM
CM41106-ZW000	0,03	41106-ZW-000

2-25 HP



ZN	KG (KG)	AL	KG (KG)	OEM
CM688-45251-01	0,03	CM688-45251-01A	0,01	688-45251-01

Serie 2-115  
60, 85, 115 HP



ZN	KG (KG)	AL	KG (KG)	OEM
CM6H1-45251-01	0,56	CM6H1-45251-01A	0,23	6H1-45251-01



ZN	KG (KG)
CM825171	0,29

30-50 hp



ZN	KG (KG)	AL	KG (KG)	OEM
CM62Y-11325-00	0,02	CM62Y-11325-00A	0,01	62Y-11325-00

40-200 hp





ZN	 (KG)	OEM
CM6G1-45251-03	0,17	6G1-45251-03 6GH-45251-00 6N0-WG525-00

6C - 6D - 8C



ZN	 (KG)	AL	 (KG)	OEM
CM15008	0,014	CM15008A	0,006	66M-11325-00

9.9hp



ZN	 (KG)	OEM
CM42121	0,03	

6 - 9.9 hp



ZN	 (KG)	OEM
CM6G1-45251-02	0,03	6G1-45251-02

6 - 8 hp



ZN	 (KG)	OEM
CM6E8-45251-00	0,06	6E8-45251-00

9.9 hp



ZN	 (KG)	OEM
CM6U0-45251-00	1,5	6U0-45251-00



ZN	 (KG)	OEM
CM6E8-45251-01	0,15	6E8-45251-02

9.9 - 15 hp



ZN	 (KG)	OEM
CM6T4-45836-00	1,44	6T4-45836-00

V8



ZN	 (KG)	OEM
CM6G8-45251-01	0,20	6G8-45251-00

9.9 hp



ZN	 (KG)	OEM
CM6T5-45373-00	1,07	6T545373-00

130 - 260 hp



ZN	 (KG)	OEM
CM66M-45371-00	0,08	66M-45371-00

9.9 hp - 4T



ZN	 (KG)	OEM
CM67F-11325-00	0,06	67F-11325-00

80 - 100 hp



ZN	 (KG)	OEM
CM63D-45251-01	0,54	63D-45251-01



ZN	 (KG)	AL	 (KG)	OEM
CM6L5-45251-02	0,06	CM6L5-45251-02A	0,03	6L5-45251-02

3,5 hp



ZN	 (KG)	AL	 (KG)	OEM
CM6G8-11325-00	0,02	CM6G8-11325-00A	0,004	6G8-11325-00

2.5 - 9.0 hp



ZN	 (KG)	OEM
CM6E5-45371-10	0,23	6E5-45371-10

60 - 225 hp



ZN	 (KG)	AL	 (KG)	OEM
CM82795M	0,19	CM82795MA	0,07	

25, 30 hp



ZN	 (KG)	AL	 (KG)	OEM
CM67C-45371-00	0,21	CM67C-45371-00A	0,09	67C-45371-00

F25 - F40 - F50 - F60



ZN	 (KG)	AL	 (KG)	OEM
CM688-45371-02	0,48	CM688-45371-02A	0,19	688-45371-02

60 - 90 hp



ZN	 (KG)	AL	 (KG)	OEM
CM85007	0,01	CM85007A	0,004	688-11325-00

25-90 hp



ZN	 (KG)	AL	 (KG)	OEM
CM679-45251-00	0,56	CM679-45251-00A	0,213	679-45251-00

55 hp



ZN	 (KG)	AL	 (KG)	OEM
CM61A-45371	0,63	CM61A-45371-00A	0,25	61A-45371-00

250 hp



ZN	 (KG)	AL	 (KG)	OEM
CM6J9-45371-01	0,50	CM6J9-45371-01A	0,20	6J9-45371-01

150, 200 hp



ZN	 (KG)	AL	 (KG)	OEM
CM61N-45251-01	0,26	CM61N-45251-01A	0,10	61N-45251-01

4T, 9.9, 15F, 25 hp



ZN	 (KG)	AL	 (KG)	OEM
CM6K1-45371-02	0,50	CM6K1-45371-02A	0,21	6J9-45371-02

150, 200 hp

CONTRAROTACIÓN  
COUNTERROTATION  
CONTROROTANTE  
CONTRE ROTATION



ZN	 (KG)	AL	 (KG)	OEM
CM664-45371-01	0,28	CM664-45371-01A	0,11	664-45371-01A

20, 25, 30 hp



ZN	 (KG)	AL	 (KG)	OEM
CM69L-45371-00	0,52	CM69L-45371-00A	0,21	69L-45371-00



ZN	 (KG)	OEM
CM6T5-45371-00	0,52	6T5-45371-00

130 - 160 hp



ZN	 (KG)	AL	 (KG)	OEM
CM6AW-45373-00	1,09	CM6AW-45373-00A	0,42	6AW-45373-00

300 - 350 hp

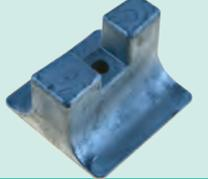

ZN	 (KG)	AL	 (KG)	OEM
REC6E5-45371-01	0,42	CM6E5-45371-01A	0,17	6E5-45371-01

115 - 225 HP (V-4 - V6)

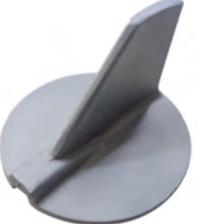

ZN	 (KG)	AL	 (KG)	OEM
CM6AW-45251-00	0,66	CM6AW-45251-00A	0,25	6AW-45251-00

200 - 350 hp



ZN	 (KG)	AL	 (KG)	OEM
CM6K1-45371-00	0,42	CM6K1-45371-00A	0,17	6K1-45371-00

115 - 225 HP (V-4 - V6)

CONTRAROTACIÓN  
COUNTERROTATION  
CONTROROTANTE  
CONTRE ROTATION



ZN	 (KG)	AL	 (KG)	OEM
CM6AW-45619-00	0,27	CM6AW-45619-00A	0,103	6AW-45619-00

300 - 350 hp

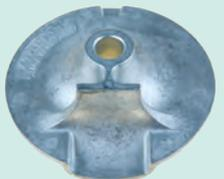

ZN	 (KG)	AL	 (KG)	OEM
CM63P-11325-11	0,02	CM63P-11325-11A	0,008	63P-11325-11

150 - 300 hp



ZN	 (KG)	AL	 (KG)	OEM
CM6BL-11325-00	0,02	CM6BL-11325-00A	0,007	6BL-11325-00

BLOC  
F20 / T,F25



ZN	 (KG)	AL	 (KG)	OEM
CM67F-11325-01	0,044	CM67F-11325-01A	0,017	67F-11325-01

75 - 350 hp



ZN	 (KG)	OEM
CM61A-11325-00	0,02	61A-11325-00

BLOC  
V6



ZN	 (KG)	AL	 (KG)	OEM
CM67F-45371-00	0,407	CM67F-45371-00A	0,156	67F-45371-00

50 - 225 hp



ZN	 (KG)	AL	 (KG)	OEM
CM63P-11325-01	0,022	CM63P-11325-01A	0,008	63P-11325-00 63P-11325-01

F150 - F350 (2004+)



ZN	 (KG)	AL	 (KG)	OEM
CM68T-11325-00	0,011	CM68T-11325-00A	0,004	68T-11325-00

BLOC  
6 - 300 hp

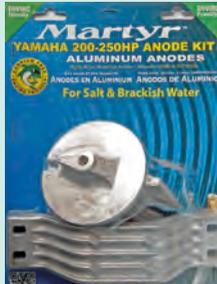
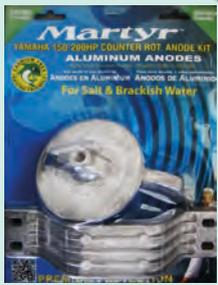

KITS DE ÁNODOS		ANODES KIT		KIT ANODI		KIT ANODES	
AL CMY150KITA	MG CMY150KITM			AL CMY200250KITA	MG CMY200250KITM		
150 - 200 hp				200 - 250 hp			
AL CMY150CRKITA	MG CMY150CRKITM			AL CMYHP200300KITA	MG CMY200300KITM		
150, 200 hp				200 - 300 hp			
CONTRAROTACIÓN COUNTERROTATION CONTROROTANTE CONTRE ROTATION							
AL CMY300350KITA	MG CMY300350KITM			AL CMY4060KITA	MG CMY4060KITM		
300 - 350 hp				4T 40 - 60 hp			
AL CMY300350XPKITA	MG CMY300350XPKITM			AL CMY6090KITA	MG CMY6090KITM		
300 - 350 hp				60 - 90 hp			
AL CMY4050KITA	MG CMY4050KITM			AL CMY80100KITA	MG CMY80100KITM		
40 - 50 hp				80 - 100 hp			

# ÁNODO

# ANODE

# ANODI

# ANODE



ZN	OEM	KG
TEN01109	677-45251-00	0,02

2 - 25 hp

ZN	OEM	KG
TEN01132	67C-45251-00 63D-45251-10	0,12

T25, F30, F40, F50, F60, hp

ZN	OEM	KG
TEN01110	688-45251-01	0,04

60 - 85 - 115 hp

ZN	OEM	KG
TEN01142	68T-45251-00	0,10

F8C - 68T (2000) - 4T

ZN	OEM	KG
TEN01111		0,210

Serie 2 - 115 hp  
70 -85 hp

ZN	OEM	KG
TEN01147	688-11325-00	0,01

25 - 90 hp

ZN	OEM	KG
TEN01165	63P-11325-21-00	0,03

ZN	OEM	KG
TEN01152	6E5-11325-00	0,01

100 - 225 hp

ZN	OEM	KG
TEN01148	6G8-11325-00	0,01

2.5 - 9 hp

ZN	OEM	KG
TEN01146	67F-11325-00	0,07

80 - 100 hp

ZN	OEM	KG
TEN01149	62Y-11325-00	0,02

40- 200 hp

ZN	OEM	KG
TEN01146-1	67F-11325-01	0,05

80 - 100 hp

ZN	OEM	KG
TEN01150	6J8-11325-00	0,02

20- 25 hp

ZN	OEM	KG
TEN01151	66M-11325-00	0,01

9.9 hp

ZN	OEM	KG
TEN01168	61A-11325-00	0,02

ZN	KG	AL	KG	OEM
TEN01135	0,27	TEN01135A	0,11	61N-45251-01

4T - 9,9 - 15F - 25 hp

YAMAHA

ZN	OEM	KG (kg)
TEN01137	6G8-45251-00	0,20

9.9 hp

ZN	OEM	KG (kg)
TEN01118	6G1-45251-03	0,175

6C - 6D - 8C HP

ZN	OEM	KG (kg)
TEN01138	6AV-45251-00 6V3-45251-01	0,28

TD

ZN	OEM	KG (kg)
TEN01122	6T4-45836-00	1,49

V8

ZN	KG (kg)	AL	KG (kg)	OEM
TEN01123	0,10	TEN01123A	0,04	6E0-45251-11-00 65W-45251-00

40 hp

ZN	KG (kg)	AL	KG (kg)	OEM
TEN01100	0,21	TEN01100A	0,08	664-45371-01

20 - 25 - 30 HP

ZN	OEM	KG (kg)
TEN01105	6E5-45251-00	0,15

115 - 225 hp

ZN	KG (kg)	AL	KG (kg)	OEM
TEN01101	0,46	TEN01101A	0,17	679-45371-00

55 HP 10x1,25

ZN	OEM	KG (kg)
TEN01106	6E8-45251-00	0,045

9.9 hp

ZN	OEM	KG (kg)
TEN01102		0,62

55 HP 10x1,25

ZN	OEM	KG (kg)
TEN01116	6E8-45251-02	0,14

9.9 - 15 hp

ZN	KG (kg)	AL	KG (kg)	OEM
TEN01103	0,39	TEN01103A	0,15	6L6-45371-00

115 - 225 HP  
V4 - V6

ZN	OEM	KG (kg)
TEN01136	66M-45371-00	0,09

9.9 4T hp

ZN	KG (kg)	AL	KG (kg)	OEM
TEN01104	0,43	TEN01104A	0,17	688-45371-02

60 - 90 hp

ZN	OEM	KG (kg)
TEN01153	6E5-45371-00	0,337

60 - 225 hp

ZN	KG (kg)	AL	KG (kg)	OEM
TEN01104	0,43	TEN01104A	0,17	688-45371-02

60 - 90 hp

ZN	OEM	KG (kg)
TEN01119	6T5-45371-00	0,58

130 - 205 - 230 - 260 hp

ZN	OEM	KG (kg)
TEN01131	63D-45251-00 63D-45251-01	0,57

H.C. 48

ZN	KG (kg)	AL	KG (kg)	OEM
TEN01124	0,68	TEN01124AL	0,27	61A-45371-00

250A hp

ZN	KG (kg)	AL	KG (kg)	OEM
TEN01154	0,69	TEN01154AL	0,69	6AH-45251-00

ZN	OEM	KG (kg)
TEN01130		0,27

25 - 30 hp

ZN	OEM	KG (kg)
TEN01129	6E5-45251-00	0,24

75 HP - XR6

ZN	KG (kg)	AL	KG (kg)	OEM
TEN01133	DX220 0,63	TEN01133AL	0,26	6J9-45371-01
TEN01134	SX220 0,63			6K1-45371-02

150 - 200 HP

ZN	OEM	KG (kg)
TEN01157	6U0-45251-00	1,50

TD

ZN	OEM	KG (kg)
TEN01140	67F-45371-00	0,40

80 - 100 HP 4T

ZN	OEM	KG (kg)
TEN01107		0,03

9.9 hp

ZN	KG (kg)	AL	KG (kg)	OEM
TEN01141	0,22	TEN01141AL	0,09	67F-45371-00

F40 - F50 - F60 4T

ZN	OEM	KG (kg)
TEN01108	6G1-45251-02	0,04

6 - 8 hp

ZN	OEM	KG (kg)
TEN01143	6J9-45371-00	0,56

150 - 225 HP

ZN	OEM	KG (kg)
TEN01169	6AW-45619-00	0,30

ZN	(KG)	AL	(KG)	OEM
TEN01155	1,05	TEN01155AL	0,4	6AW-45373-00



ZN	OEM	(KG)
TEN01112-1	6AW-45251	0,65

200 - 350 hp



ZN	OEM	(KG)
TEN01158	6U4-45373-00	0,33



ZN	OEM	(KG)
TEN01162	682-11325-00	0,02



ZN	OEM	(KG)
TEN01117	6L5-45251-02	0,07

Malta 3,5 HP  
+ 2B - 3A - 4A - 5C



ZN	OEM	(KG)
TEN01164	63P-11325-11-00	0,02



ZN	OEM	(KG)
TEN01166	676-11325-00	0,03



ZN	OEM	Ø (mm)	(KG)
TEN01127	676-45251-00	20	0,02
TEN01128	682-45251-00	24	0,02



ZN	OEM	(KG)
TEN01167	63P-11325-01-00	0,02



ZN	OEM	(KG)
TEN01161	6BL-11325-00	0,02



ZN	(KG)	AL	(KG)	OEM
TEN01115	0,46	TEN01115AL	0,18	6H1-45251-02

TOP 700



ZN	OEM	(KG)
TEN01163	68T-11325-00	0,02



ZN	OEM	(KG)
TEN01125	6H1-45251-01	1,20

150 - 200 hp



ZN	(KG)	AL	(KG)	OEM
TEN01112	0,90	TEN01112AL	0,36	6G5-45251-01 6G5-45251-02



ZN	OEM	(KG)
TEN01120	6T5-45373-00	0,77

130 - 205 - 230 - 260 hp



ZN	OEM	(KG)
TEN01113	6H1-45251-03	0,55

60 - 90 hp





ZN	OEM	KG (kg)
TEN01126		0,29

30 - 40 hp

ZN	OEM	KG (kg)
TEN01159	6U4-45251-00	0,60

ZN	OEM	KG (kg)
TEN01121	689-11325-00	0,02

W30 - W8 25/2/3 hp

ZN	OEM	KG (kg)
TEN01160T	N51-11325-01	0,60

ZN	KG (kg)	AL	KG (kg)	OEM
TEN01156	0,03	TEN01156AL	0,02	68V-11325-02

ZN	KG (kg)	AL	KG (kg)	OEM
TEN01156-1	0,07	TEN01156/1AL	0,03	68V-11325-01

ZN	OEM	KG (kg)	Ø (mm)	(mm)	
TEN01114		0,09	20	39	M8

ZN	OEM	KG (kg)
TEN01139	6T5-45251-00	0,35

ZN	OEM	KG (kg)	Ø (mm)	(mm)
TEN01170	6AW-1132S-00	0,035	14	40
TEN01171	6AQ-1132N-00	0,030	14	38

300 - 350 hp

ZN	OEM	KG (kg)	Ø (mm)	(mm)
TEN01172	6AW-1132R-00	0,022	16	20

300 - 350 hp

ZN	OEM	KG (kg)	Ø (mm)	(mm)
TEN01173	6AW-1132L-00	0,026	19	15

300 - 350 hp

ZN	OEM	KG (kg)
TEN01174	6AW-1132U-00	0,06

300 - 350 hp

ZN	OEM	KG (kg)
TEN01175	6AW-1132T-00	0,06

300 - 350 hp

ZN	OEM	KG (kg)
TEN01176	6AW-1132M-00	0,12

300 - 350 hp

ZN	OEM	 (kg)
TEN01177	6AW-1132P-00	0,034

300 - 350 hp



**new**

ZN	OEM	 (kg)
TEN01145	69L-45371-00	0,66



ZN	 (kg)	AL	 (kg)	OEM
TEN01144	0,41	TEN01144AL		6K1-45371-00



**KITS DE ÁNODOS      ANODES KIT      KIT DE ANODI      KIT ANODES**

ZN	 (kg)
TENKITYAMAHA150-200	

150 - 200 hp



**new**

ZN	 (kg)
TENKITYAMAHA200-300	

200 - 300 hp



**new**

ZN	 (kg)
TENKITYAMAHA150-200C	

150, 200 hp

CONTRAROTACIÓN  
COUNTERROTATION  
CONTORROTANTE  
CONTRE ROTATION



**new**

ZN	 (kg)
TENKITYAMAHA40-60	

40 - 60 hp



**new**

ZN	 (kg)
TENKITYAMAHA200-250	

200 - 250 hp



**new**

ZN	 (kg)
TENKITYAMAHA60-90	

60 - 90 hp



**new**

**TAPA DE ÁNODO (66M)      COVER ANODE (66M)      COPERCHIO ANODO (66M)      COUVERCLE DU ANODE (66M)**

REF	OEM
PAF15-07010011	66M-11327-00-94



**new**

GUÍA DE ÁNODOS		ANODES APPLICATION		GUIDA ANODI		GUIDE DES ANODES	
	OEM	TECNOSEAL		CANADA METAL			
		ZN	AL	ZN	AL		
<b>CILINDRO   CYLINDER   CILINDRO   MOTEURS</b>							
F2.5A, 2B, 3A, F4A, 4A, 5C (1989+), F4B, F5A, F6C	6L5-45251-03	TEN01117		CM6L5-45251-02	CM6L5-45251-02A		
4A, 5C (-1989), F8A/B, F9.9A/B	677-45251-00	TEN01109		CM43107M			
4A, 5C, F8A/B/, 6C/D, 8C, F9.9A/B(1989+), 9.9D, 15/6C/D, 8C (1990+)	6E0-45251-12	TEN01123	TEN01123AL	CM6E0-45251-11	CM6E0-45251-11A		
6C/D, 8C (-1989)	6GH-45251-00	TEN01118		CM6G1-45251-03			
F6A/B, F8C, F9.9F, F9.9J	6N0-WG525-00	TEN01108		CM6G1-45251-02			
F8A/B, 9.9D, F9.9B, 15D, F9.9A(-1994)	68T-45251-00	TEN01142		CM68T-45251-00	CM68T-45251-00A		
F9.9A, FT9.9A (1994+)	6E8-45251-02	TEN01116		CM6E8-45251-01			
FT8, 9.9F, F9.9C, FT9.9D, FT9.9G, FT9.9L, 15F, F15A, F20A, F25A, 25B/V, F25D, 30G/H, 40V/X, F30A, F40A/B/C, F50A/F, 50H, FT25B/C (2000+)	6G8-45251-01	TEN01137		CM6G8-45251-01			
F15C, F20B	61N-45251-01	TEN01135	TEN01135AL	CM61N-45251-01	CM61N-45251-01A		
FT25F, F30B, F40F, F60A/C, FT60B, 40V/X, 50H, F40A, F50A/B(-1999), F50H, F60F	6AH-45251-00	TEN01154	TEN01154AL				
F25G	67C-45251-00	TEN01132		CM67C-45251-00			
F50H, F60F, FT50J, FT60G	6G8-45251-01	TEN01148		CM6G8-11325-00			
F(L)300A, F(L)350A	65W-45251-00	TEN01123	TEN01123AL	CM6E0-45251-11	CM6E0-45251-11A		
	6AW-45373-00	TEN01155	TEN01155AL	CM6AW-45373-00	CM6AW-45373-00A		
<b>TRIM</b>							
F9.9C, F15A	66M-45371-00	TEN01136		CM66M-45371-00			
40Q, 50G, 55B, PRO50	679-45371-00	TEN01101	TEN01101AL				
20C/D, 25D/N, 30A/D, 40H/V/X, 50D/H, F40A, F45A, F50A(-2000)	664-45371-01	TEN01100	TEN01100AL	CM664-45371-01	CM664-45371-01A		
FT25B/C, F30A, FT25F, F25G, F30B, F40F, F40A/B/C, F50A/F, F50H, F60A/C, F60F	67C-45371-00	TEN01141	TEN01141AL	CM67C-45371-00	CM67C-45371-00A		
60F, 70B, 75A/C, PRO75, 80A, 85A, 90A, FT50B(-2000), FTC/G, FT50J, FT60B/D, FT60G, F70A, F80A/B, F100A/D	67F-45371-00	TEN01104	TEN01104AL	CM688-45371-02	CM688-45371-02A		
100A, 115A/B/C, 130B, 140A/B, F100B/F, F115A/B, 150A, 175A, 200A, PROV100	6E5-45371-01	TEN01103	TEN01103AL	REC6E5-45371-01	CM6E5-45371-01A		
150A, 175A, 200A(1998+), 150C/F, 175B/D, 200B/F/G, 225A/B/D/F, PROV200, F150A, Z150P/Q, Z175G/H, Z200N, F200F, F(L)200G	6J9-45371-01	TEN01133	TEN01133AL	CM6J9-45371-01	CM6J9-45371-01A		
150A, 175A, 200A	6K1-45371-00	TEN01144	TEN01144AL	CM6K1-45371-00	CM6K1-45371-00A		
LF150A, L150C/F, L200B/F, LZ150P, LZ200N	6K1-45371-02	TEN01134		CM6K1-45371-02	CM6K1-45371-02A		
FL115A, FL115B, L130B, L140B	6L6-45371-00	TEN01103		REC6E5-45371-01	CM6E5-45371-01A		
(L)225C/G, (L)250A/B, F(L)200A, F(L)200C, F(L)225A, F(L)225B, F(L)250A, F(L)250B, F(L)225F, F(L)250C, F(L)300B	61A-45371-00	TEN01124	TEN01124AL	CM61A-45371	CM61A-45371-00A		
Z200P, (L)Z250D/F, (L)Z300A	69L-45371-00	TEN01145		CM69L-45371-00	CM69L-45371-00A		
<b>BRACKET</b>							
FT8D, FT9.9D, F15A/C, F20A/B, F25A/G(PT model), FT25B, F30A, 30D, F40B/C, 40X/V, FT50C, 50H, F60A, FT60B, F70A	65W-45251-00	TEN01123	TEN01123AL	CM6E0-45251-11	CM6E0-45251-11A		
25B/Q, 40H, 50D/G, 55B, 60F, 70B, 75A/C, 80A, 85A, 90A, F80A/B, F100A/D, F(L)115B, PRO50/75 (1990+)	6H1-45251-03	TEN01115	TEN01115AL	CM6H1-45251-02	CM6H1-45251-02A		
40H, 50D, 60F, 70B, 80A, 90A(1989+)	99999-03935	TEN01113		CM6H1-45251-01			
40H, 50D, 60F, 70B, 80A, 90A(-1989)	688-45251-01	TEN01110		CM688-45251-01	CM688-45251-01A		
25B, FT25B, F30A, 40V, F40A/B, F45A, FT50A/B, 50G/H, PRO50, 55B, 60F, 70B	663-45251-00	TEN01110		CM688-45251-01	CM688-45251-01A		
40V, F40A, F45A, 50H, F50A, FT50B	63D-45251-01	TEN01131		CM63D-45251-01	CM63D-45251-01A		
115A, 140A, 150A, 175A, 200A, 220A	6E5-45251-00	TEN01105		CM6E5-45251-00	CM6E5-45251-00A		
100A, 115B/C, F(L)115A, (L)130B, (L)140B	6G5-45251-02	TEN01112	TEN01112AL	CM6G5-45251-01	CM6G5-45251-01A		
PROV100, 150, 200, Vmax	6AW-45251-00	TEN01112-1		CM6AW-45251-00	CM6AW-45251-00A		
(L)F150A, (L)150A/C/F, 175A/B/D/F	6AW-45251-00	TEN01112-1		CM6AW-45251-00	CM6AW-45251-00A		
(L)200A/B/F/G, (L)225A/B/C/D/G, (L)250A/B	6AW-45251-00	TEN01112-1		CM6AW-45251-00	CM6AW-45251-00A		
(L)Z150P/Q, Z175G/H/(L), Z200N/P	6AW-45251-00	TEN01112-1		CM6AW-45251-00	CM6AW-45251-00A		
Z250D/F, F(L)200A, F200B, F(L)200C	6AW-45251-00	TEN01112-1		CM6AW-45251-00	CM6AW-45251-00A		
F(L)225A, F(L)225B, F225C, F(L)250A	6AW-45251-00	TEN01112-1		CM6AW-45251-00	CM6AW-45251-00A		
F(L)250B, (L)Z300A, F(L)300A, F(L)350A	6AW-45251-00	TEN01112-1		CM6AW-45251-00	CM6AW-45251-00A		
F(L)225F, F(L)250D, F(L)300B	6AW-45251-00	TEN01112-1		CM6AW-45251-00	CM6AW-45251-00A		
F(L)200F, F(L)200G	6AW-45251-00	TEN01112-1		CM6AW-45251-00	CM6AW-45251-00A		
<b>F300A, F350A (V8)</b>							
TAPA TERMOSTATO   THERMOSTAT COVER	6AW-1132R-00	TEN01172					
COPERCHIO TERMOSTATO   COUVERCLE DU THERMOSTAT							
PARA REGULADOR   FOR REGULATOR   PER REGOLATORE   POUR REGULATEUR	6E5-11325-00	TEN01152		CM15026	CM15026A		
BLOQUE   BLOCK   BLOCCO   MOTEUR	6AW-1132P-00	TEN01177					
BLOQUE   BLOCK   BLOCCO   BLOQUE	63P-11325-01	TEN01167		CM63P-11325-01			
TAPA ESCAPE   EXHAUST COVER   COPERCHIO SCARICO   PLAQUE D'ECHAPPEMENT	6AW-1132M-00	TEN01176					
ESCAPE   EXHAUST   SCARICO   ECHAPPEMENT	99999-03946	TEN01171					
ESCAPE   EXHAUST   SCARICO   ECHAPPEMENT	6AW-1132L-00	TEN01173					
PLACA ESCAPE   EXHAUST PLATE   PIASTRA SCARICO   PLAQUE D'ECHAPPEMENT	6AW-1132T-00	TEN01175					
PLACA ESCAPE   EXHAUST PLATE   PIASTRA SCARICO   PLAQUE D'ECHAPPEMENT	6AW-1132S-00	TEN01170					
ANODO PLACA ESCAPE	63P-11325-11	TEN01164		CM63P-11325-11			
<b>COLAS (DIESEL)   STERN DRIVE (DIESEL)   PIEDI (DIESEL)   EMBASE (DIESEL)</b>							
Intermedio   Intermediate   Intermedio   Intermediaire - ME422	6U0-45251-00	TEN01157		CM6U0-45251-00			
TRP Drive (Trasero   Rear   Posteriore   Arrière) - ME422	6U4-45251-00	TEN01159		CM6U4-45251-00			
TRP Drive (Frontal   Front   Anteriore   Avant) - ME422	6U4-45373-00	TEN01158					

# PARTES DEL MOTOR ENGINE PARTS

# PARTI MOTORE PIECES MOTEUR

DESPIECE MOTOR  
DE 4 TIEMPOS

ENGINE PARTS  
4 STROKES

PARTI MOTORI  
4 TEMPI

PIECES MOTEURS  
DE 4 TEMPS

4T F2.5 AMH/MLH/MSH/MHA (2003+)  
STROKES

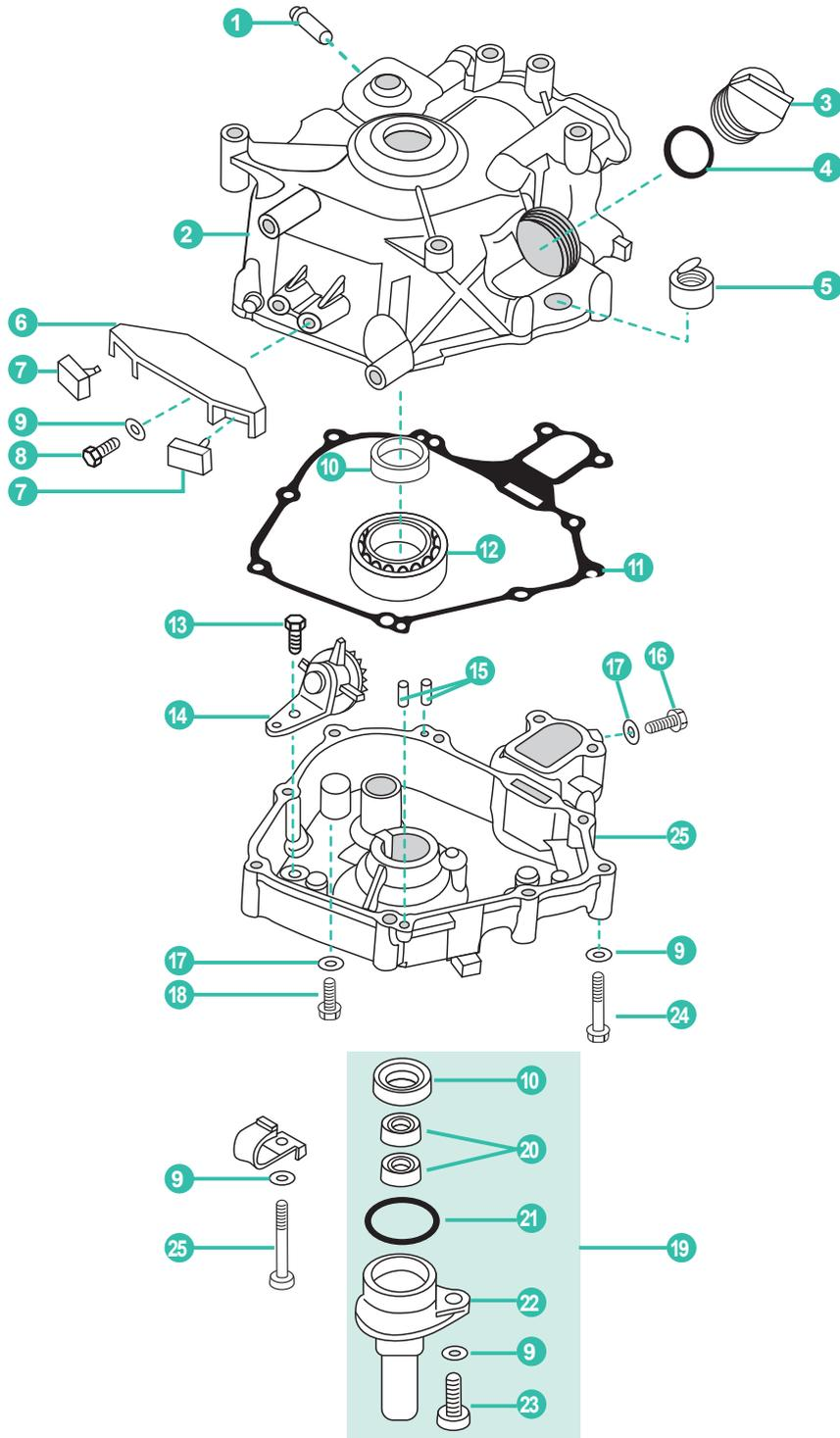

YAMAHA

	REF	OEM					UN.
1	PAT15-04010202	6H1-14485-00	PIPA DE AGUA	PIPE, WATER	TUBO	RACCORD TUYAU D'EAU	1
2	PAF2.6-04010100	69M-E1311-00-1	CARCASA MOTOR	CRANK CASE	COPERCHIO MOTORE	VILEBREQUIN	1
3	PAF15-07050004	69M-E5363-00	TAPÓN ACEITE	PLUG, OIL	TAPPO OLIO	BOUCHON REMPLISSAGE D'HUILE	1
4	PAJASOF40431-025	93210-24M79	ARO TÓRICO	O-RING	O-RING	JOINT TORIQUE	1
5	PAF2.6-04010102	69M-15361-00	INDICADOR NIVEL	GAUGE, LEVEL	INDICATORE LIVELLO	JAUGE DE NIVEAU	1
6	PAF2.6-04000008	69M-G2743-00	SOPORTE MOTOR	BRACKET, DAMPER	SUPPORTO MOTORE	SUPPORT	1
7	PAF2.6-04000009	6G8-44532-00	GOMA SOPORTE	RUBBER BLOCK, DAMPER	GOMMA SUPPORTO	SILENT BLOC	2
8	PAGB/T5783-M6X20	97095-06020	TORNILLO	SCREW	VITE	VIS	2
9	PAGB/T97.1-6	92995-06600	ARANDELA	WASHER	RONDELLA	RONDELLE	11
10	PAF2.6-04010001	93102-20108	RETÉN	OIL SEAL	PARAOLIO	JOINT	2
11	PAF2.6-04000004	69M-11351-A0	JUNTA CÁRTER	CRANK CASE COMPLEX GASKET	GUARNIZIONE COPPA L'OLLIO	JOINT DE CARTER	1
12	PAGB/T276-62/22/P6	93306-272Y2	RODAMIENTO	BALL BEARING	CUSCINETTO	ROULEMENT À BILLE	1
13	PAGB/T5783-M6X12	95817-06012	TORNILLO	SCREW	VITE	VIS	1
14	PAF2.6-04050100	69M-E3102-00	PIÑÓN	GEAR UNIT ASSY	PIGNONE	PIGNON	1
15	PAF15-00000013	93604-12M07	PIN	PIN	SPINOTTO	GOUPILLE FENDUE	2
16	PAGB/T5783-M8X14	97095-08014	TORNILLO	SCREW	VITE	VIS	1
17	PAF4-04000006	90201-08818-00	ARANDELA	WASHER	RONDELLA	RONDELLE	2
18	PAF4-04000001	90105-08M76	TORNILLO DRENAJE	BOLT, DISCHARGING OIL	VITE DRENAGGIO	VIS DE VIDANGE	1
19	PAF2.6-04060000	69M-E5396-00-5B	RETÉN Y CUERPO, COMPLETO	OIL SEAL SHELL ASSY	GUARNIZIONE E CORPO COMPLETO	LOGEMENT JOINT D'HUILE, COMPLÈTE	1
20	PAF2.6-04060002	93210-09004	RETÉN	OIL SEAL	PARAOLIO	JOINT	2
21	PAF4-04060002	93210-35537	ARO TÓRICO	O RING	O-RING	JOINT TORIQUE	1
22	PAF2.6-04060001	69M-E5396-00	CUERPO DEL RETÉN	SHELL, OIL SEAL	GUARNIZIONE CORPO	LOGEMENT JOINT D'HUILE	1
23	PAGB/T5783-M5X12	90465-08M99	TORNILLO	SCREW	VITE	VIS	1
24	PAGB/T5783-M5X12	97013-06045	TORNILLO	SCREW	VITE	VIS	8
25	PAF2.6-04050001	69M-E5111-00-1S	CARTER	CRANKCASE COVER	CARTER	CARTER	1



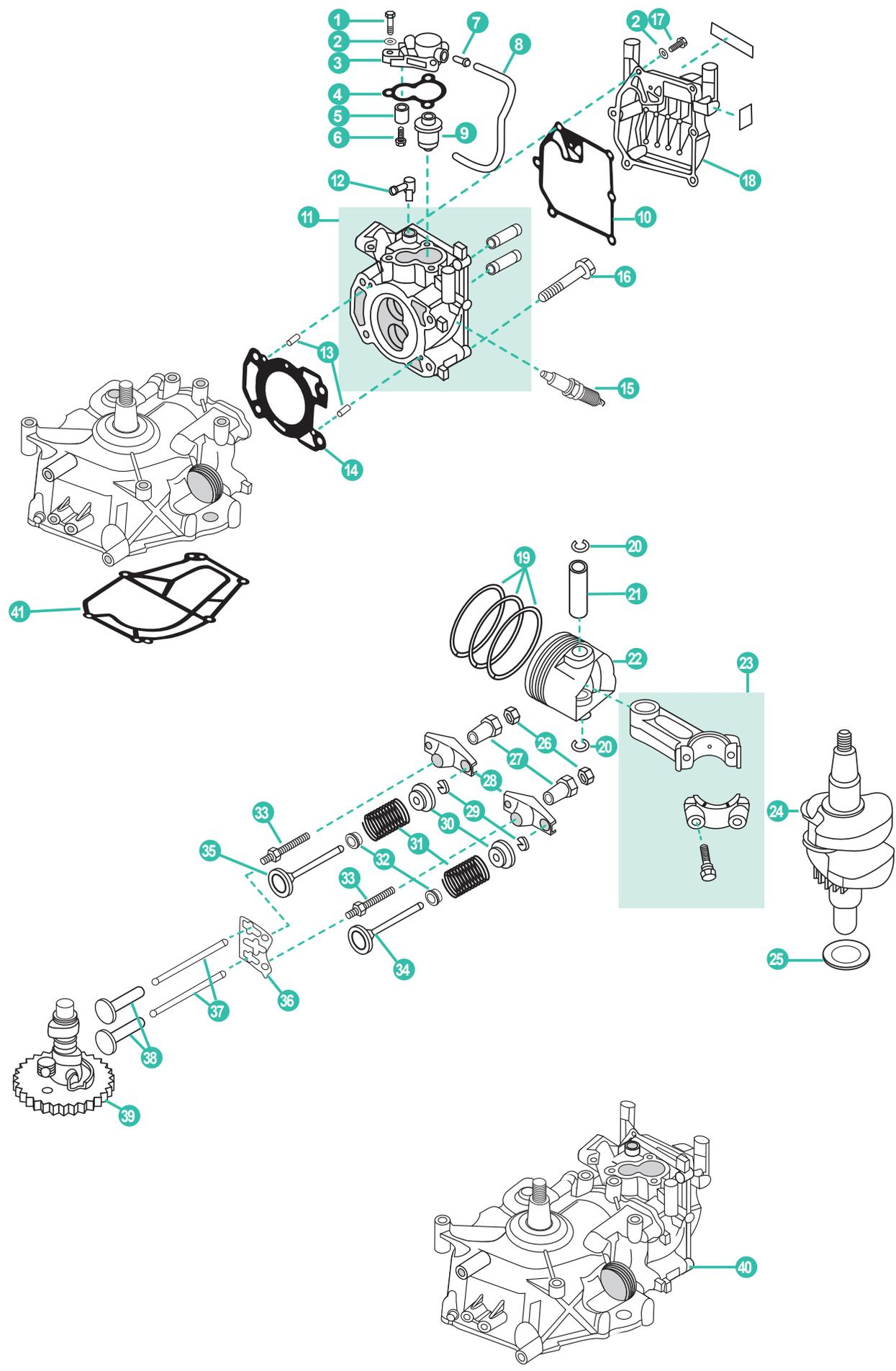

	REF	OEM					UN.
1	PAGB/T5783-M6X20	97095-06020	TORNILLO	SCREW	VITE	VIS	3
2	PAGB/T97.1-6	92995-06600	ARANDELA	WASHER	RONDELLA	RONDELLE	9
3	PAF2.6-04000501	69M-E2413-00-1S	TAPA TERMOSTATO	COVER, THERMOSTAT	COPERCHIO TERMOSTATO	COUVERCLE THERMOSTAT	1
4	PAF4-04000011	68D-E2414-A0	JUNTA TAPA TERMOSTATO	GASKET, THERMOSTAT COVER	GUARNIZIONE COPERCHIO TERMOSTATO	JOINT COUVERCLE DE THERMOSTAT	1
5	PAF4-04070003	68D-E1325-00	ÁNODO	ANODE	ANODO	ANODE	1
6	PAGB/T818-M5X25	97880-05025	TORNILLO	SCREW	VITE	VIS	1
7	PAF4-04010102	650-24378-00	PIPA	PIPE, JOINT	TUBO	RACCORD TUYAU D'EAU	1
8	PAF2.6-04000007	90445-09808	TUBO DE AGUA	WATER TUBE	TUBO DELL'ACQUA	DURITE D'EAU	1
9	REC6AH-12411-00	69M-12411-01	TERMOSTATO	THERMOSTAT	TERMOSTATO	THERMOSTAT	1
10	PAF2.6-04000005	69M-11193-A0	JUNTA TAPA BALANCINES	GASKET, CYLINDER COVER	GUARNIZIONE COPERCHIO PUNTERIE	JOINT DE CACHE CULBUTEUR	1
11	PAF2.6-04040100	69M-E1111-00-1S	CULATA COMPLETA	CYLINDER HEAD ASSY	TESTATA COMPLETA	CULASSE COMPLETE	1
12	PAF15-04000005	676-11372-00	NIPLE	NIPPLE	TUBO	RACCORD D'EAU	1
13	PAF15-00000013	93604-12M07	PIN	PIN, DOWEL	SPINOTTO	GOUPILLE FENDUE	2
14	PAF2.6-04000001	69M-11181-00	JUNTA CULATA	GASKET, CYLINDER HEAD	GUARNIZIONE TESTATA	JOINT DE CULASSE	1
15	NGKBR6HS	94702-00248	BUJÍA F2.5A	SPARK PLUG F2.5A	CANDELA F2.5A	BOUGIE F2.5A	1
	NGKCR6HSB	94702-00372	BUJÍA F2.5B	SPARK PLUG F2.5B	CANDELA F2.5B	BOUGIE F2.5B	1
16	PAF4-04000034	90105-08M36	TORNILLO	SCREW	VITE	VIS	4
17	PAGB/T5783-M6X16	90105-06039	TORNILLO	SCREW	VITE	VIS	6
18	PAF2.6-04000006	69M-E1191-00-1S	TAPA BALANCINES	COVER, CYLINDER HEAD	COPERCHIO PUNTERIE	CACHE CULBUTEUR	1
19	REC69M-E1603-01	69M-E1603-01	KIT SEGMENTOS	PISTON RING KIT	KIT FASCIA	KIT DE SEGMENTS	1
20	PAF2.6-04020006	93450-13130	CIRCLIP	CIRCLIP	CIRCLIP	CIRCLIP	2
21	PAF2.6-04020005	69M-E1633-00	PIN, PISTÓN	PIN, PISTON	SPINOTTO PISTONE	AXE DE PISTON	1
22	PAF2.6-04020001	69M-E1631-01-96	PISTÓN	PISTON	PISTONE	PISTON	1
23	PAF2.6-04020100	69M-11650-00	BIELA	ROD, CONNECTING	BIELLA	BIELLE	1
24	PAF2.6-04030000	69M-11400-00	CIGÜEÑAL	CRANK ASSY	ALBERO MOTORE	VILEBREQUIN	1
25	PAF2.6-04000003	90201-23008	ARANDELA	WASHER	RONDELLA	RONDELLE	1
26	PA166F-010011	7FK-12158-00	TUERCA	LOCK NUT	DADO	ÉCROU	2
27	PA166F-010010	7FK-12165-00	TUERCA BALANCÍN	PIVOT, ROCKER ARM	DADO BILANCERE	PIVOT CULBUTEUR	2
28	PA166F-010009	67D-12151-00	BALANCÍN	ARM, VALVE ROCKER	BILANCERE	CULBUTEUR	2
29	PAF8-05030007	7NJ-12118-00	SEGURO DE VÁLVULA	CLAMP, VALVE	BLOCCAGGIO DI VALVOLA	CLAVETTE DE SOUPAPE	2
30	PAF8-05030006	7NJ-12117-00	RETÉN DE RESORTE	SPRING, VALVE RETAINER	VALVOLA DI RITEGNO	JOINT DE RESSORT	2
31	PAF4-04080008	68D-E2113-00	MUELLE DE VÁLVULA	SPRING, VALVE STEM	MOLLA DI VALVOLA	RESSORT DE SOUPAPE	2
32	PA166F-010003	51Y-12119-00	RETÉN DE VÁLVULA	SEAT, VALVE STEM	TENUTA	JOINT QUEUE DE SOUPAPE	2
33	PA166F-010008	67D-12157-00	TORNILLO BALANCÍN	BOLT, ROCKER ARM	VITE PUNTERIE	VIS DE BRAS A BASCULE	2
34	PA166F-010001	67D-12111-00	VÁLVULA ADMISIÓN	VALVE, INTAKE	VALVOLA ASPIRAZIONE	SOUPAPE D ADMISSION	1
35	PA166F-010002	67D-12121-00	VÁLVULA ESCAPE	VALVE, EXHAUST	VALVOLA SCARICO	SOUPAPE D'ÉCHAPPEMENT	1
36	PAF2.6-04040001	69M-E2155-00	PLETINA EMPUJADORES	PLATE, PUSH ROD	PIASTRA, ASTA DI SPINTA	PLAQUE DE POUSSOIRS	1
37	PAF2.6-04000002	69M-12154-00	VARILLA EMPUJADOR	ROD, VALVE PUSH	ASTICELLA DI SPINTA	TIGE DE CULBUTEUR	2
38	PA166F-000001	JA9-12153-00	EMPUJADOR	LIFTER, VALVE	ASTA	POUSSOIR	2
39	PAF2.6-04000100	69M-12170-01	ÁRBOL DE LEVAS	CAMSHAFT ASSY	ALBERO A CAMME	ARBRE À CAMES	1
40	POWERHEAD2.6	69M-WE0090-01-1S	MOTOR	POWER HEAD	MOTORE	TÊTE MOTRICE	1
41	PAF2.6-00000003	69M-45113-A0	JUNTA BASE MOTOR	GASKET ENGINE	GUARNIZIONE BASE MOTORE	JOINT MOTEUR	1

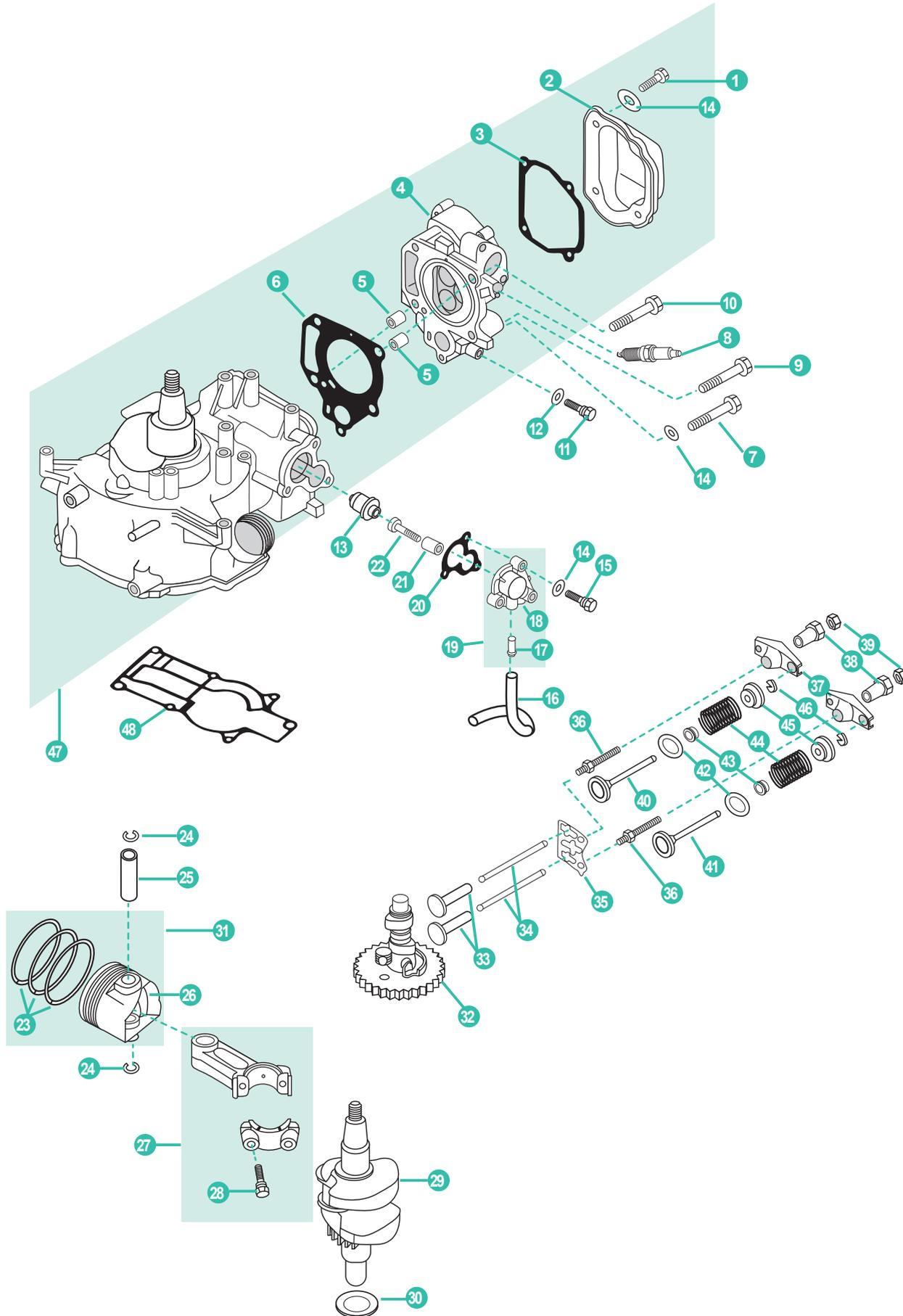



	REF	OEM				UN.	
1	PAGB/T5783-M6X16	90105-06M14	TORNILLO	SCREW	VITE	VIS	4
2	PAF4-04000018	67D-11191-00	TAPA BALANCINES	COVER, CYLINDER HEAD	COPERCHIO PUNTERIE	CACHE CULBUTEUR	1
3	PAF4-04000017	68D-E1193-A0	JUNTA TAPA	GASKET, COVER	GAURNIZIONE COPERCHIO	JOINT COUVERCLE	1
4	PAF4-04080101	68D-E1111-10-1S	CULATA	CYLINDER, HEAD	TESTATA	CULASSE	1
5	PAF4-04000003	99510-10114	PIN	PIN, HOLLOW	SPINOTTO	GOUPILLE FENDUE	2
6	PAF4-04000014	67D-11181-A0	JUNTA CULATA	GASKET, CYLINDER HEAD	GUARNIZIONE TESTATA	JOINT DE CULASSE	1
7	PAGB/T5782-M6X45	90105-06M25	TORNILLO	SCREW	VITE	VIS	1
8	NGKBPR7HS	94702-00248	BUJÍA	SPARK PLUG	CANDELA	BOUGIE	1
9	PAF4-04000034	90105-08M36-00	TORNILLO	SCREW	VITE	VIS	3
10	PAF4-04000033	90105-08046-00	TORNILLO	SCREW	VITE	VIS	1
11	PAGB/T5783-M8X14	97095-08014-00	TORNILLO	SCREW	VITE	VIS	1
12	PAF4-04000006	90430-08800-00	ARANDELA	WASHER, PLATE	RONDELLA	RONDELLE	1
13	REC6AH-12411-00	69M-12411-01	TERMOSTATO	TEHRMOSTAT	TERMOSTATO	THERMOSTAT	1
14	PAGB/T97.1-6	92995-06600	ARANDELA	WASHER, PLATE	RONDELLA	RONDELLE	8
15	PAGB/T5783-M6X20	97095-06020-00	TORNILLO	SCREW	VITE	VIS	3
16	PAF4-04000012	90445-09807	TUBO	PIPE, RETURN	TUBO	DURITE D'EAU	1
17	PAF4-04010102	650-24378-00	PIPA DE AGUA	PIPE, WATER	TUBO	RACCORD TUYAU D'EAU	1
18	PAF4-04070001	67D-12413-00-1S	TAPA TERMOSTATO	COVER, THERMOSTAT	COPERCHIO TERMOSTATO	COUVERCLE THERMOSTAT	1
19	PAF4-04070100	68D-E2413-001S	TAPA TERMOSTATO COMPLETA	COVER ADN SPLIE WATER ASSY	TAPPO TERMOSTATO COMPLETO	COUVERCLE DE THERMOSTAT COMPLET	1
20	PAF4-04000011	68D-E2414-A0	JUNTA TAPA TERMOSTATO	GASKET, THERMOSTAT	GUARNIZIONE COPERCHIO TERMOSTATO	JOINT COUVERCLE DE THERMOSTAT	1
21	PAF4-04070003	68D-E1325-00	ÁNODO	ANODE	ANODO	ANODE	1
22	PAGB/T818-M5X25	97880-05025-00	TORNILLO	SCREW, PANHEAD	VITE	BOULON	1
23	REC68D-E1603-00	68D-E1603-00	KIT SEGMENTOS DE PISTÓN	PISTON RING KIT	KIT FASCIA PISTONE	KIT DE SEGMENTS	1
24	PAF4-04020006	93450-14088	CIRCLIP	CIRCLIP	CIRCLIP	CIRCLIP	2
25	PAF4-04020005	68D-E1633-00	PIN, PISTÓN	PIN, PISTON	SPINOTTO PISTONE	AXE DE PISTON	1
26	PAF4-04020001	68D-E1631-00-96	PISTÓN	PISTON	PISTONE	PISTON	1
27	PAF4-04020100	67D-11650-00	BIELA	ROD, CONNECTING	BIELLA	BIELLE	1
28	PAF4-04020103	67D-11654-00	TORNILLO	SCREW	VITE	VIS	2
29	PAF4-04030000	67D-11400-00	CIGÜEÑAL	CRANK ASSY	ALBERO MOTORE	VILEBREQUIN	1
30	PAF4-04000004	90201-266P2	ARANDELA	WASHER, PLATE	RONDELLA	RONDELLE	1
31	PAF4-04020200	68D-E1631-00-96	PISTÓN	PISTON ASSY	PISTONE	PISTON	1
32	PAF4-04040000	68D-E2170-00	ÁRBOL DE LEVAS	CAMSHAFT ASSY	ALBERO A CAMME	ARBRE À CAMES	1
33	PA166F-000001	JA9-12153-00	EMPUJADOR DE VÁLVULA	LIFTER, VALVE PUSH	ALZA VALVOLA	POUSSOIR	2
34	PAF4-04000015	67D-12154-00	VARILLA EMPUJADOR DE VÁLVULA	ROD, VALVE PUSH	ASTA, ALZA VALVOLA	TIGE DE CULBUTEUR	2
35	PAF4-04080009	68D-E2155-00	PLETINA EMPUJADORES	PLATE, PUSH ROD	PIASTRA, ASTA DI SPINTA	PLAQUE DE POUSSOIRS	1
36	PA166F-010008	67D-12157-00	TORNILLO	SCREW	VITE	VIS	2
37	PA166F-010009	67D-12151-00	BALANCIÓN	VALVE ROCKER	BILANCERE	CULBUTEUR	2
38	PA166F-010010	7FK-12165-00	TUERCA BALANCIÓN	PIVOT, ROCKER ARM	DADO BILANCERE	ECROU DU CULBUTEUR	2
39	PA166F-010011	7FK-12158-00	TUERCA	LOCKNUT	DADO	ECROU	1
40	PAF4-04080005	67D-12111-00	VÁLVULA ADMISIÓN	VALVE, INTAKE	VALVOLA ASPIRAZIONE	SOUPAPE D ADMISSION	1
41	PAF4-04080006	67D-12121-00	VÁLVULA ESCAPE	VALVE, EXHAUST	VALVOLA SCARICO	SOUPAPE D'ECHAPPEMENT	1
42	PAF4-04080007	68T-12116-00	ARANDELA ASIENTO	SEAT, VALVE SPRING	RONDELLA BASAMENTO	SIEGE RESSORT DE SOUPAPE	2
43	PAPS2700.04.03	51Y-12119-00	RETÉN DE VÁLVULA	SEAT, VALVE STEM	GOMMINO VALVOLA	JOINT QUEUE DE SOUPAPE	2
44	PAF4-04080008	68D-E2113-00	MUELLE	SPRING, VALVE INNER	MOLLA	RESSORT DE SOUPAPE	2
45	PAF8-05030006	7NJ-12117-00	RETÉN RESORTE	SPRING, VALVE RETAINER	VALVOLA DI RITEGNO	JOINT DE RESSORT	2
46	PAF8-05030007	7NJ-12118-00	SEGURO DE VÁLVULA	CLAMP, VALVE	BLOCCAGGIO DI VALVOLA	CLAVETTE DE SOUPAPE	2
47	PAF4-04000000	680-WE090-11-15	MOTOR	POWER HEAD 4-5	MOTORE	TÊTE MOTRICE	1
48	PAF4-00000006	67D-45113-A0	JUNTA BASE MOTOR	GASKET ENGINE	GUARNIZIONE BASE MOTORE	JOINT MOTEUR	1

4T F4A/MSHAC/AMH/MLHB-S/MH/MLHE (2002-09)  
STROKES

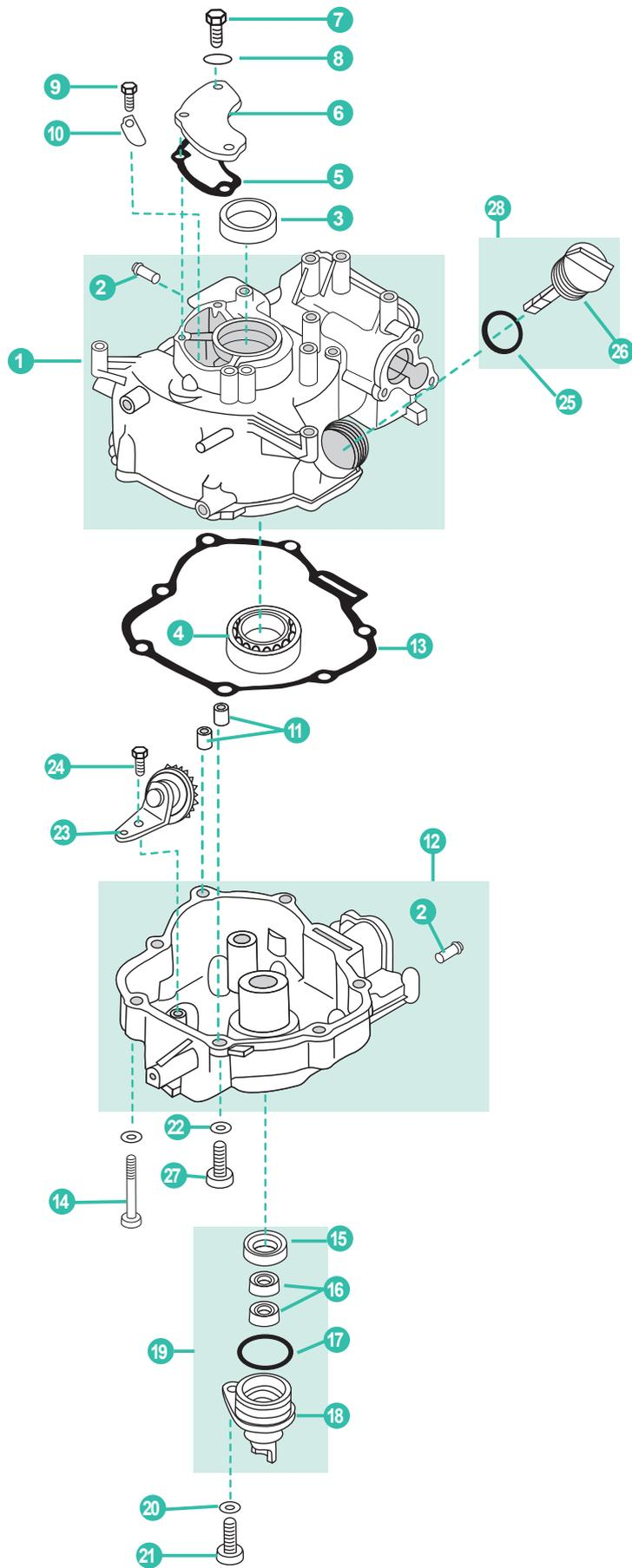

	REF	OEM				UN.	
1	PAF4-04010100	68D-E1311-02-15	CARCASA DE MOTOR	CRANK CASE	COPERCHIO MOTORE	VILEBREQVIN	1
2	PAF4-04010102	650-24378-00	PIPA DE AGUA	PIPE, WATER	TUBO	RACCORD TUYAU D'EAU	2
3	PAF4-04010004	93102-25090	RETÉN	OIL SEAL	PARAOLIO	JOINT	1
4	PAGB/T276-6004C2	93306-205YD	RODAMIENTO	BALL BEARING	CUSCINETTO	ROULEMENT À BILLE	1
5	PAF4-04000009	68D-E1169-A0	JUNTA	BREATHER GASKET	GUARNIZIONE	JOINT	1
6	PAF4-04000010	68D-E1168-00	TAPA	COVER	COPERCHIO	COUVERCLE	1
7	PAGB/T5783-M6X14	90119-06M80-00	TORNILLO	SCREW	VITE	VIS	3
8	PAGB/T97.1-6	92885-06600	ARANDELA	WASHER	RONDELLA	RONDELLE	3
9	PAGB/T818-M4X6	98503-04066-00	TORNILLO	SCREW	VITE	VIS	1
10	PAF4-04010003	68D-E5346-00	VÁLVULA	VALVE	VALVOLA	SOUPAPE	1
11	PAF4-04000003	99510-10114	PIN	HOLLOWPIN	SPINOTTO	GOUPILLE FENDUE	2
12	PAF4-04050200	68D-E5111-00-1S	CARTER	COVER, CRANK CASE	CARTER	CARTER	1
13	PAF4-04000002	68D-11351-A0	JUNTA CARTER	CRANK CASE COMPLEX	GUARNIZIONE CARTER	JOINT DE CARTER	1
14	PAGB/T5787-1986	97575-08550-00	TORNILLO	SCREW	VITE	VIS	7
15	PAF2.6-04010001	93102-20108	RETÉN	OIL SEAL	PARAOLIO	JOINT	1
16	PAF4-04060004	93102-10004	RETÉN	OIL SEAL	PARAOLIO	JOINT	2
17	PAF4-04060002	93210-35537	TÓRICA	O-RING	O-RING	JOINT TORIQUE	1
18	PAF4-04060001	68D-E5396-00-5B	CUERPO DEL RETÉN	SHELL, OIL SEAL	GUARNIZIONE CORPO	LOGEMENT JOINT D'HUILE	1
19	PAF4-04060000	6EE-E5396-00-CA	CUERPO RETÉN COMPLETO	OIL SEAL, SHELL ASSY	CORPO GUARNIZIONE COMPLETO	LOGEMENT JOINT D'HUILE, COMPLET	1
20	PAGB/T97.1-8	92955-08600-00	ARANDELA	WASHER, PLATE	RONDELLA	RONDELLE	8
21	PAGB/T5783-M8X20	97095-08020-00	TORNILLO	BOLT, HEXAGON	VITE	BOULON	1
22	PAF4-04000006	90201-08818	ARANDELA	WASHER	RONDELLA	RONDELLE	1
23	PAF4-04050100	68D-E3102-00	PIÑÓN COMPELTO	GEAR UNIT ASSY	PIGNONE	PIGNON	1
24	PAGB/T5783-M6X12	95817-06012-00	TORNILLO	SCREW	VITE	VIS	1
25	PAF4-04000008	93210-24M79	TÓRICA	O-RING	O-RING	JOINT TORIQUE	1
26	PAF4-04000007	68D-E5362-00	TAPÓN MEDIDOR NIVEL	PLUG WITH DIPSTICK	TAPPO LIVELLO	BOUCHON AVEC JAUGE D'HUILE	1
27	PAF4-04000001	97095-08020-00	TORNILLO DRENAJE	BOLT, DISCHARGING OIL	VITE DRENAGGIO	VIS DE VIDANGE	1
28	PAF4-04000036	6EE-E5362-00	TAPÓN COMPLETO	PLUG ASSY	TAPPO COMPLETO	BOUCHON COMPLET	1



4T F4B-M • F5A • F6C-M  
STROKES

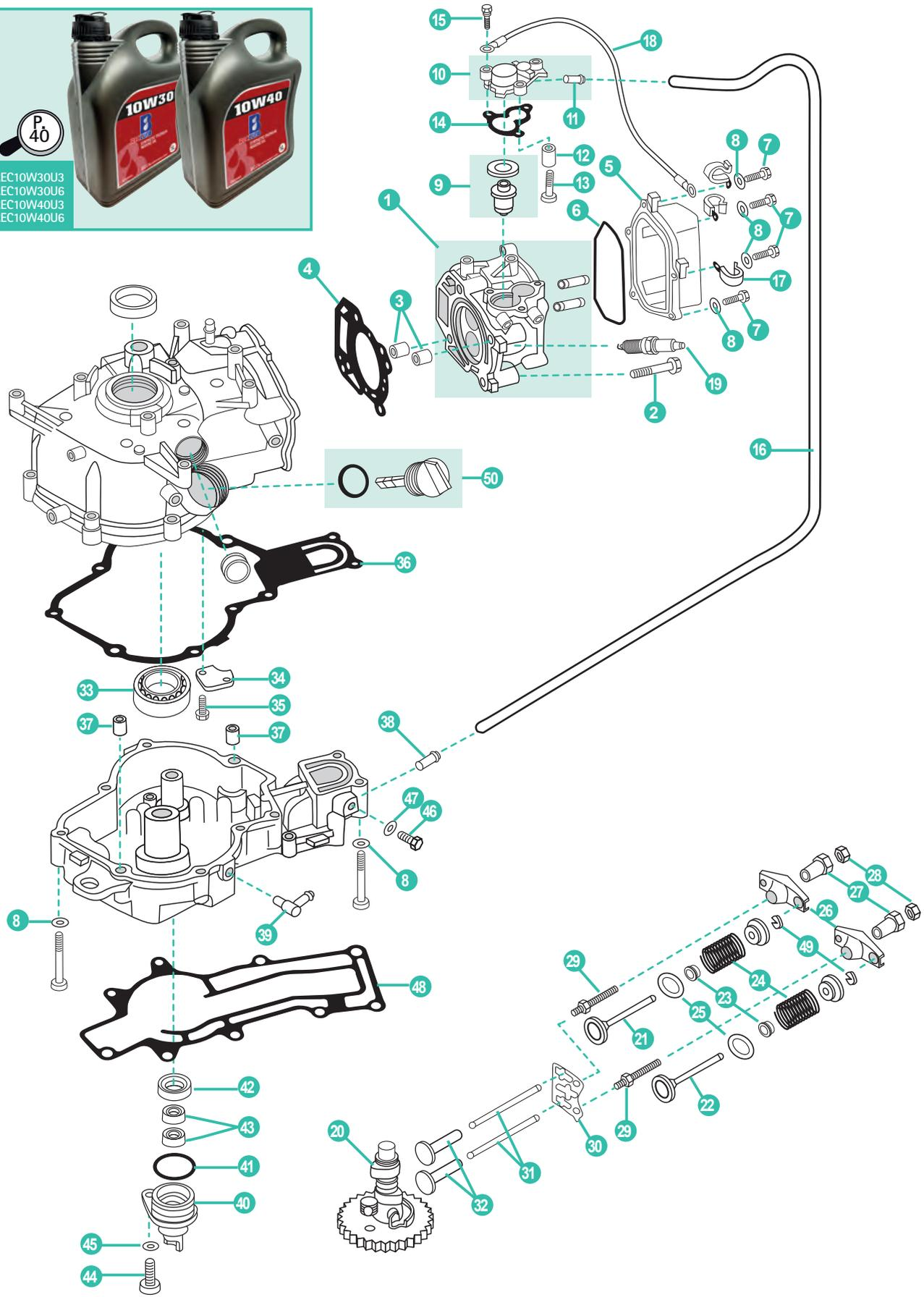

	REF	OEM					UN.
1	PAF6-04050100	6BX-E1111-00-1S	CULATA COMPLETA	CYLINDER HEAD ASSY	TESTATA COMPLETA	CULASSE COMPLETE	1
2	PAF4-04000034	90105-08M36	TORNILLO	SCREW	VITE	VIS	4
3	PAF4-04000003	99510-10114	PIN CENTRADOR	HOLLOW PIN	SPINOTTO DI CENTRAGGIO	PIN DE CENTRAGE	2
4	PAF6-04000002	6BX-11181-00	JUNTA CULATA	GASKET, CYLINDER HEAD	GUARNIZIONE TESTATA	JOINT DE CULASSE	1
5	PAF6-04000004	6BX-E1191-00-5B	TAPA CULATA DE CILINDRO	COVER CYLINDER HEAD	COPERCHIO TESTA CILINDRO	CACHE CULBUTEUR	1
6	PAF6-04000005	6BX-11356-00	RETÉN DE ACEITE	SEAL RING	PARAOLIO	JOINT CACHE CULBUTEUR	1
7	PAGB/T5783-M6X20	97095-06020	TORNILLO	SCREW	VITE	VIS	5
8	PAGB/T97.1-6	92995-06600	ARANDELA	WASHER	RONDELLA	RONDELLE	15
9	PAF15-07000031	66M-12411-01	TERMOSTATO	THERMOSTAT	TERMOSTATO	THERMOSTAT	1
10	PAF4-04070000	68D-E2413-00-1S	TAPA TERMOSTATO	COVER, THERMOSTAT	COPERCHIO TERMOSTATO	COUVERCLE THERMOSTAT	1
11	PAF4-04010102	650-24378-00	NIPLE	NIPPLE	RACCORDO	RACCORD	1
12	PAF4-04070003	68D-E1325-00	ÁNODO	ANODE	ANODO	ANODE	1
13	PAGB/T818-M5X25	97880-05025	TORNILLO	SCREW	VITE	VIS	1
14	PAF4-04000011	68D-E2414-A0	JUNTA TAPA TERMOSTATO	GASKET, THERMOSTAT COVER	GUARNIZIONE COPERCHIO TERMOSTATO	JOINT COUVERCLE DE THERMOSTAT	1
15	PAGB/T5783-M6X20	90119-06MA2	TORNILLO	SCREW	VITE	VIS	3
16	PAF6-04000020	6BX-F4323-00	TUBO	TUBE	TUBO	DURITE D'EAU	1
17	PAT36-04000023	90465-06M86	BRIDA	CLAMP	FLANGIA	COLLIER	1
18	PAF6-04000009	6G0-82519-00	CABLE MASA	WIRE LEAD	PORTA CAVO	CABLE	1
19	NGKCR6HSB	94702-00372	BUJÍA	SPARK PLUG	CANDELA	BOUGIE	1
20	PAF6-04030000	6BX-E2170-00	ÁRBOL DE LEVAS	CAMSHAFT ASSY	ALBERO A CAMME	ARBRE À CAMES	1
21	PAF6-04050001	6BX-12111-00	VÁLVULA ADMISIÓN	VALVE, INTAKE	VALVOLA ASPIRAZIONE	SOUPEPE D ADMISSION	1
22	PAF6-04050002	6AU-12121-00	VÁLVULA ESCAPE	VALVE, EXHAUST	VALVOLA SCARICO	SOUPEPE D'ÉCHAPPEMENT	1
23	PAF166-010003	51Y-12119-00	RETÉN DE ACEITE	SEAL RING	PARAOLIO	JOINT D'HUILE	2
24	PAF6-04050003	60R-12113-00	RESORTE DE VÁLVULA	SPRING, VALVE	MOLLA VALVOLA	RESSORT	2
25	PAF4-04080007	68T-12116-00	RETÉN RESORTE	SPRING, VALVE RETAINER	VALVOLA DI RITEGNO	JOINT DE RESSORT	2
26	PA166F-010009	67D-12151-00	BRAZO DE BALANCÍN	ARM, VALVE ROCKER	BILANCERE	CULBUTEUR	2
27	PA166F-010010	7FK-12165-00	TUERCA BALANCÍN	PIVOT, ROCKER ARM	DADO BILANCERE	PIVOT CULBUTEUR	2
28	PA166F-010011	7FK-12158-00	TUERCA	LOCK NUT	DADO	ÉCROU	2
29	PA166F-010008	67D-12157-00	PERNO	BOLT	PERNO	BOULON	2
30	PAF6-04050004	6BX-E2155-00	PLETINA EMPUJADORES	PLATE, PUSH ROD	PIASTRA, ASTA DI SPINTA	PLAQUE DE POUSSOIRS	1
31	PAF6-04000003	6BX-12154-00	VARILLA EMPUJADOR	ROD, VALVE PUSH	ASTICELLA DI SPINTA	TIGE DE CULBUTEUR	2
32	PA166F-000001	JA9-12153-00	EMPUJADOR DE VÁLVULA	LIFTER, VALVE PUSH	ALZA VALVOLA	POUSSOIR	2
33	PANTN6205C3	93306-205B2	RODAMIENTO	BALL BEARING	CUSCINETTO	ROULEMENT À BILLE	1
34	PAF6-04010004	6BX-E1168-00	CUBIERTA DE RESPIRADERO	OIL BAFFLE PLATE	DIAFRAMMA OLIO	JOINT DE CARTER D'HUILE	1
35	PAGB/T5783-M5X10	97013-05010	PERNO	BOLT	PERNO	BOULON	2
36	PAF6-04000001	6BX-11351-00	JUNTA BASE MOTOR	GASKET ENGINE	GUARNIZIONE BASE MOTORE	JOINT MOTEUR	1
37	PAF4-04000003	99510-10114	PIN CENTRADOR	HOLLOW PIN	SPINOTTO DI CENTRAGGIO	PIN DE CENTRAGE	2
38	PAF4-04010102	650-24378-00	PIPA DE AGUA	PIPE, WATER	TUBO	RACCORD TUYAU D'EAU	1
39	PAF15-04000005	676-11372-00	NIPLE DE MANGUERA	WATER NIPPLE	RACCORDO COMPLETO	RACCORD D'EAU	1
40	PAF4-04060001	68D-E5396-00-5B	CAJA DE SELLO DE ACEITE	SHELL, OIL SEAL	GUARNIZIONE CORPO OLIO	LOGEMENT JOINT D'HUILE	1
41	PAGB/T345.2-D32.5XD1	93210-35537	TÓRICA	O-RING	O-RING	JOINT TORIQUE	1
42	PAF2.6-04010001	93102-20108	RETÉN DE ACEITE	SEAL RING	PARAOLIO	JOINT SPI	1
43	PAF4-04060004	93102-10004	RETÉN DE ACEITE	SEAL RING	PARAOLIO	JOINT SPI	2
44	PAGB/T5783-M8X20	97095-08020	PERNO	BOLT	PERNO	BOULON	1
45	PAGB/T97.1-8	92995-08600	ARANDELA	WASHER	RONDELLA	RONDELLE	1
46	PAGB/T5783-M8X14	97095-08014	PERNO	BOLT	PERNO	BOULON	1
47	PAF4-04000006	90430-08800	JUNTA	GASKET	GUARNIZIONE	JOINT	1
48	PAF6-00000001	6BX-45113-00	JUNTA	GASKET	GUARNIZIONE	JOINT	1
49	PAF8-05030007	7NJ-12118-00	CLIP	CLIP	CLIP	CLIP	1
50	PAF4-04000010	68D-E5362-00	TAPÓN COMPLETO	PLUG ASSY	TAPPO COMPLETO	BOUCHON COMPLET	1

4T F6A/M/B • FT/T/F8C/M/D/P/E/F • F9.9F • FT9.9G • F9.9J • FT9.9L  
STROKES



REC10W30U3  
REC10W30U6  
REC10W40U3  
REC10W40U6

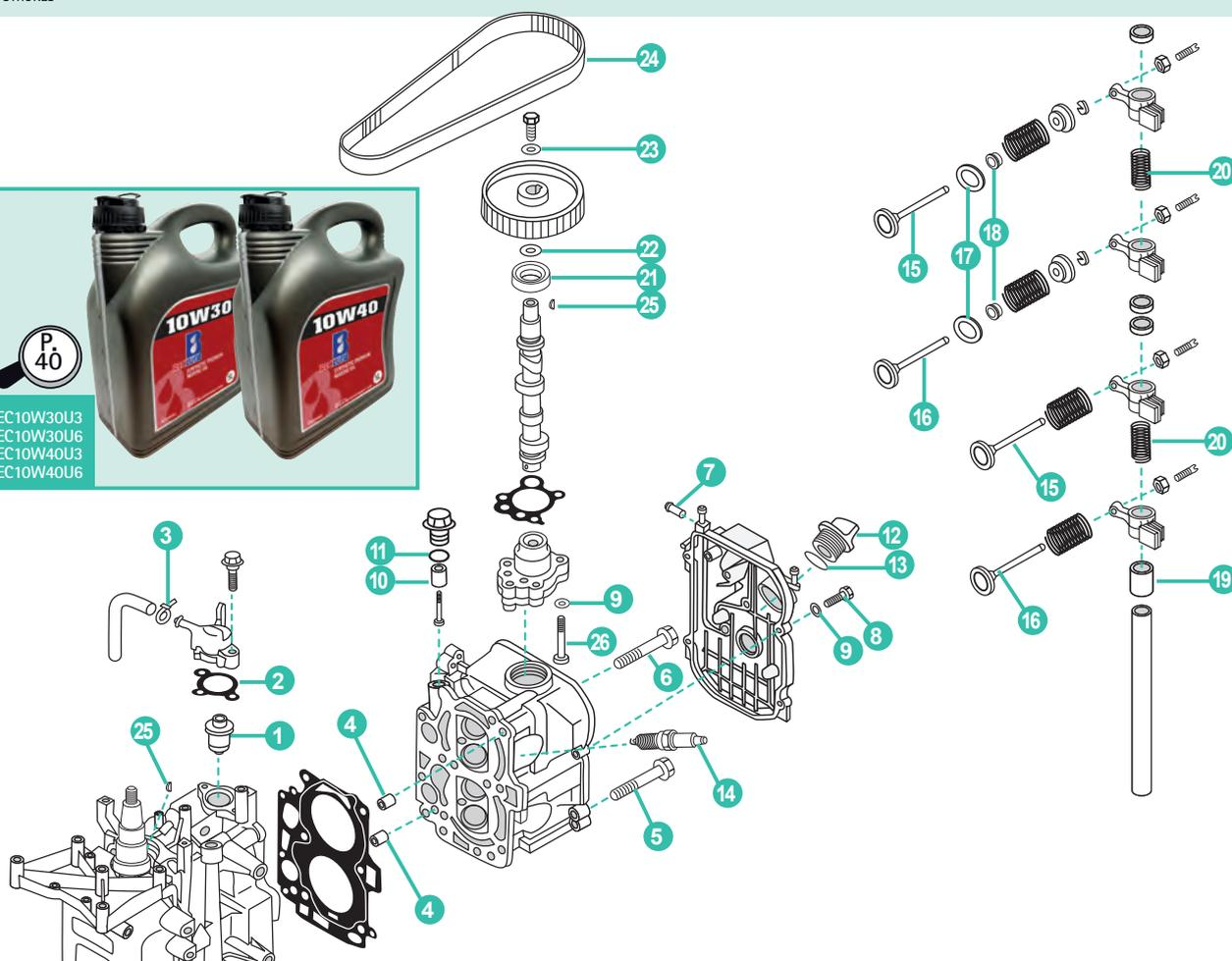

	REF	OEM				UN.	
1	PAF15-07000031	66M-12411-01	TERMOSTATO	THERMOSTAT	TERMOSTATO	THERMOSTAT	1
2	REC6G8-12414-A0	60R-E2414-A0	JUNTA	GASKET	GUANIZIONE	JOINT	1
3	PAHT-2.5X60	90465-11M10	BRIDA	CLAMP	FLANGIA	COLLIER	1
4	PAF15-07000001	99510-10114	PIN CENTRADOR	HOLLOW PIN	SPINOTTO DI CENTRAGGIO	PIN DE CENTRAGE	2
5	PAF4-04000034	90105-08M36	TORNILLO	SCREW	VITE	VIS	2
6	PAF15-07000028	90105-08M78	TORNILLO	SCREW	VITE	VIS	4
7	PAF4-04010102	650-24378-00	PIPA DE AGUA	PIPE, WATER	TUBO	RACCORD TUYAU D'EAU	1
8	PAGB/T5783-M6X20	97095-06020	TORNILLO	BOLT	VITE	BOULON	4
9	PAGB/T97.1-6	92995-06600	ARANDELA	WASHER	RONDELLA	RONDELLE	7
10	CM6G8-11325-00A	6G8-11325-00	ÁNODO	ANODE	ANODO	ANODE	1
11	PAGB/T3452.1-13X2	93210-13M63	TÓRICA	O-RING	O-RING	JOINT TORIQUE	1
12	PAF15-07050004	69M-E5363-00	TAPÓN ACEITE	PLUG, OIL	TAPPO OLIO	BOUCHON REMPLISSAGE D'HUILE	1
13	PAF4-04000008	93210-24M79	TÓRICA	O-RING	O-RING	JOINT TORIQUE	1
14	NGKBR6HS-10	94702-00274	BUJÍA	SPARK PLUG	CANDELA	BOUGIE	2
15	PA166F-010001	67D-12111-00	VÁLVULA ADMISIÓN	VALVE, INTAKE	VALVOLA ASPIRAZIONE	SOUPAPE D ADMISSION	2
16	PAF4-04080006	67D-12121-00	VÁLVULA ESCAPE	VALVE, EXHAUST	VALVOLA SCARICO	SOUPAPE D'ECHAPPEMENT	2
17	PAF4-04080007	68T-12116-00	ARANDELA DE ASIENTO	SEAT, VALVE SPRING	RONDELLA BASAMENTO	SIEGE RESSORT DE SOUPAPE	2
18	PA166F-010003	51Y-12119-00	RETÉN DE ACEITE	SEAL RING	PARAOLIO	JOINT D'HUILE	4
19	PAF15-07040012	90387-13M56	CASQUILLO	BUSHER	BOCCOLA	BAGUE	1
20	PAF15-07040014	90501-12M40	RESORTE DE COMPRESIÓN	SPRING, ROCKER	MOLLA	RESSORT ROCKER	2
21	PAF15-07040008	93102-18M21	RETÉN DE ACEITE	SEAL RING	PARAOLIO	JOINT D'HUILE	1
22	PAF15-07040017	90201-13201	ARANDELA	WASHER	RONDELLA	RONDELLE	1
23	PAGB/T5287-6	90201-06M94	ARANDELA	WASHER	RONDELLA	RONDELLE	1
24	REC68T-46241-00	60R-G6241-00	CORREA	BELT	CINGHIA	COURROIE DISTRIBUTION	1
25	PAGB/T1099-3X5X13	90280-03M01	CHAVETA	KEY WOODRUFF	CHIAVETTA	CLAVETTE	2
26	PAGB/T5783-M6X30	97095-06030	PERNO	BOLT	VITE	BOULON	3

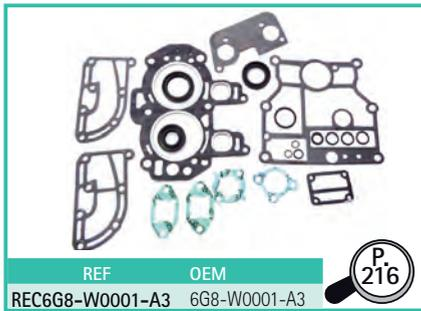
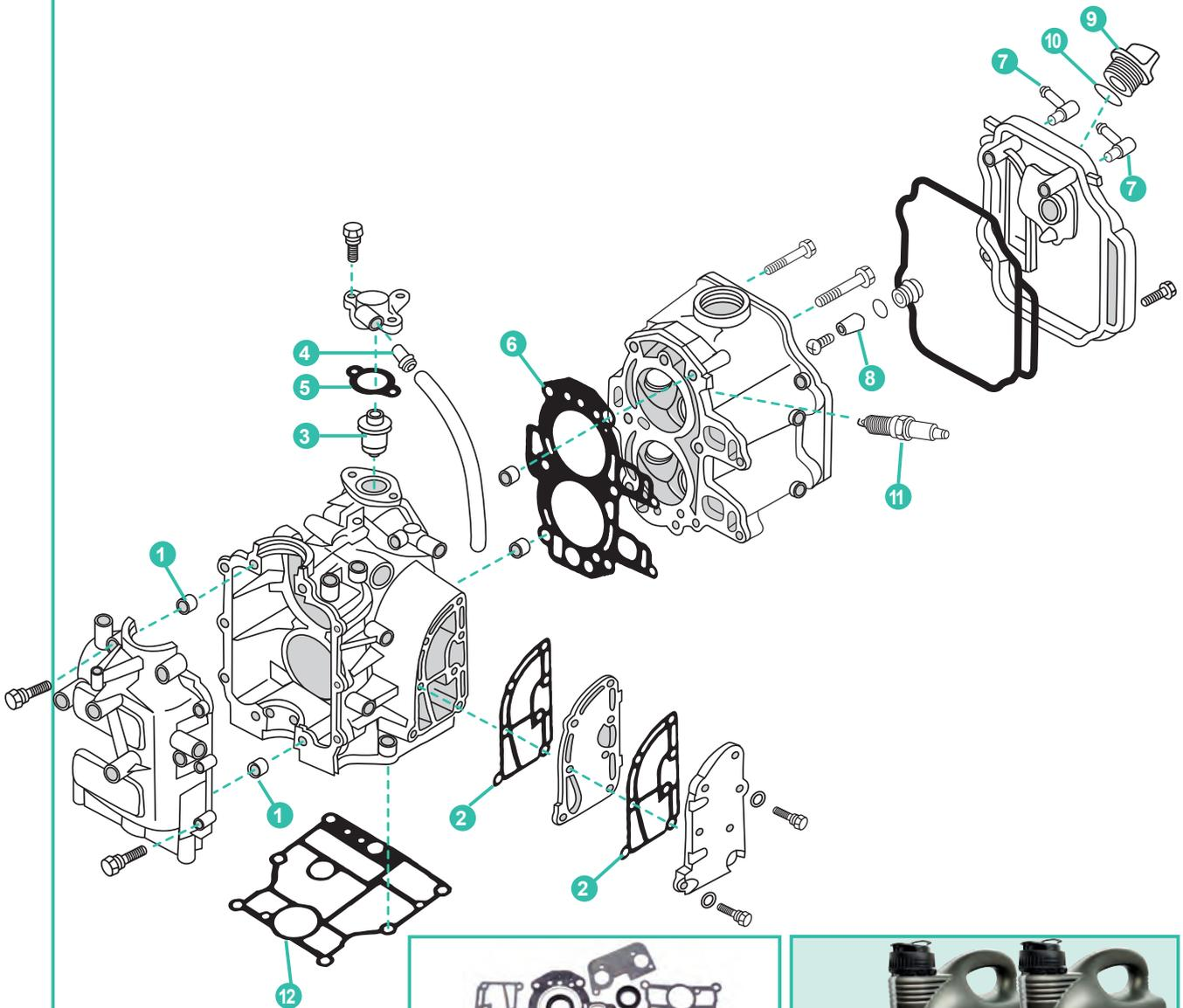

	REF	OEM					UN.
1	PAF15-07000001	91810-03014	PIN	PIN	PIN	PIN	2
2	REC6G8-41112-02	6G8-41112-02	JUNTA	GASKET	GUARNIZIONE	JOINT	2
3	REC6AH-12411-00	6G8-12411-00	TERMOSTATO	THERMOSTAT	TERMOSTATO	THERMOSTAT	1
4	PAF15-07010006	6E5-24377-00	PIPA DE AGUA	PIPE, WATER	TUBO	RACCORD TUYAU D'EAU	1
5	REC6G8-12414-A0	6G8-12414-00	JUNTA TAPA TERMOSTATO	GASKET, THERMOSTAT COVER	GUARNIZIONE COPERCHIO TERMOSTATO	JOINT COUVERCLE DE THERMOSTAT	1
6	REC6G8-11181-A1	6G8-11181-00	JUNTA CULATA	GASKET, CYLINDER HEAD	GUARNIZIONE TESTATA	JOINT DE CULASSE	1
7	PAF15-04000005	676-11372-00	NIPLA	HOSE NIPLA	TUBO	TUYAU	2
8	CM6G8-11325-00	6G8-11325-00	ÁNODO	ANODE	ANODO	ANODE	1
9	PAF15-07050004	6G8-15363-00	TAPÓN ACEITE	PLUG, OIL	TAPPO OLIO	BOUCHON REMPLISSAGE D'HUILE	1
10	PAJASOF40431-025	93210-24M79	TÓRICA	O-RING	O-RING	JOINT TORIQUE	1
11	NGKCR6HS	94701-00282	BUJÍA	SPARK PLUG	CANDELA	BOUGIE	2
12	REC6G8-11351-A0	6G8-11351-00	JUNTA BASE MOTOR	GASKET ENGINE	GUARNIZIONE BASE MOTOR	JOINT MOTEUR	1

4T STROKES F9.9 (2004-06) • F9.9C • F13.5 (2003-06) • F15 (2003-07) • F15A

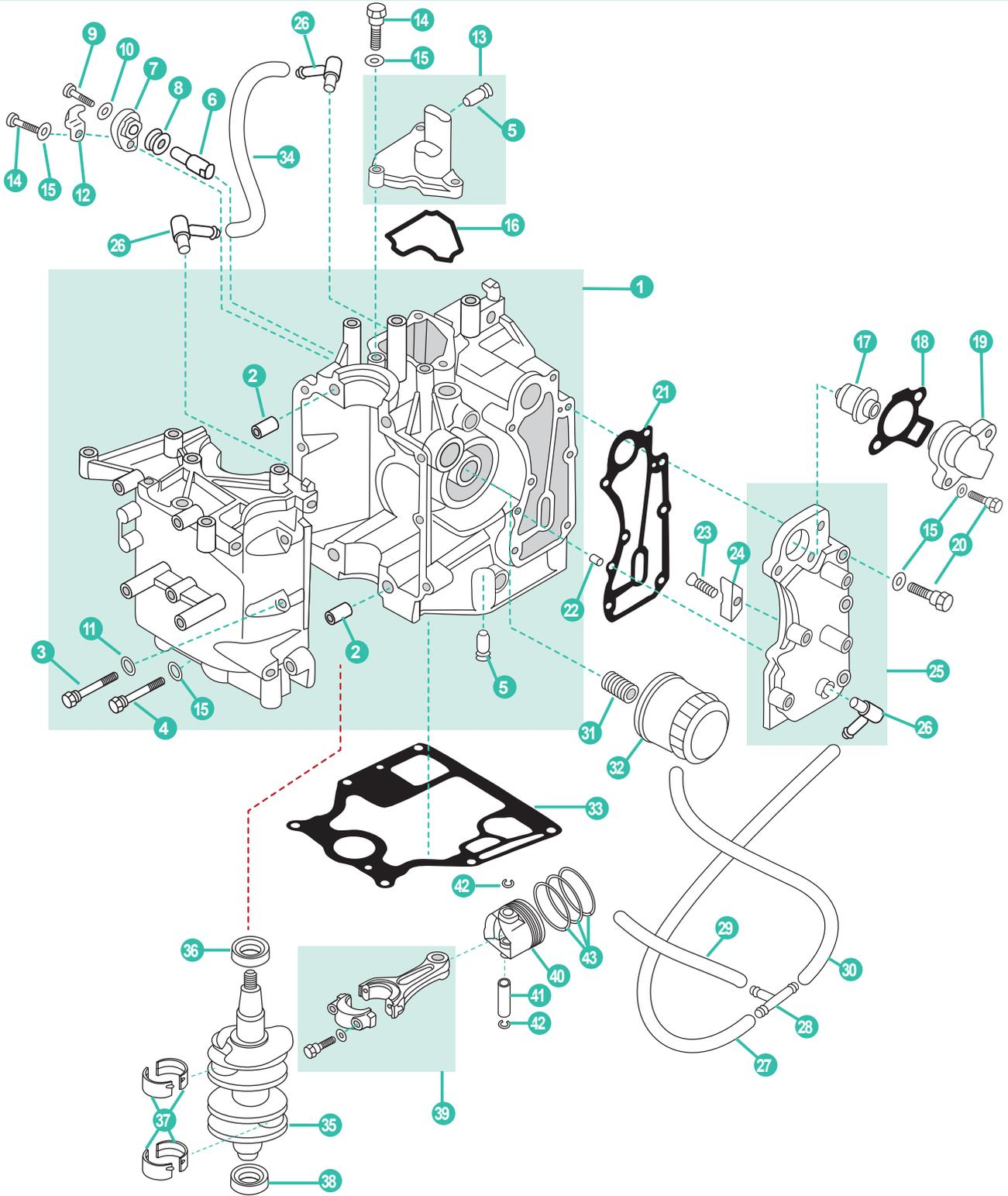

REF	OEM
REC66M-W0093-01	66M-W0093-01

P 95

REF	OEM
REC66M-W0001-01	66M-W0001-01

P 216

P 40

REC10W30U3  
REC10W30U6  
REC10W40U3  
REC10W40U6



	REF	OEM				UN.	
1	PAF15-07010000	66M-15100-02-15	BLOQUE MOTOR COMPLETO	CRANKCASE ASSY	BLOCCO MOTORE COMPLETO	CARTER BLOC MOTEUR	1
2	PAF15-07000001	99510-10114	PIN CENTRADOR	HOLLOW PIN	SPINOTTO DI CENTRAGGIO	PIN DE CENTRAGE	2
3	PAGB/T5783-M5X12	93102-25090	TORNILLO	SCREW	VITE	VIS	6
4	PAGB/T5783-M5X12	93306-205YD	TORNILLO	SCREW	VITE	VIS	4
5	PAF15-07010006	6E5-24377-00	PIPA DE AGUA	PIPE, WATER	TUBO	RACCORD TUYAU D'EAU	2
6	PAF15-07010008	66M-11325-00	ÁNODO	ANODE	ANODO	ANODE	1
7	PAF15-07010011	66M-11327-00-94	TAPA ÁNODO	COVER, ANODE	COPERTURA ANODO	COUVERCLE DU ANODE	1
8	PAF15-07010009	66M-11328-00	ALOJAMIENTO ÁNODO	GROMMET, ANODE	ALLOGGIAMENTO ANODO	JOINT D'ANODE	1
9	PAGB/T5783-M5X12	97095-0512	TORNILLO	SCREW	VITE	VIS	1
10	PAGB/T97.1-8	92995-05600	ARANDELA	WASHER	RONDELLA	RONDELLE	1
11	PAGB/T97.1-8	97595-06520	ARANDELA	WASHER	RONDELLA	RONDELLE	4
12	PAF15-07010012	66M-12535-00	EMPAQUETADORA DE ÁNODO	PLATE, ANODE	PIASTRA ANODO	PLAQUE D'ANODE	1
13	PAF15-07010200	66M-11168-001S	TAPA	COVER, BREATHER	COPERCHIO	COUVERCLE	1
14	PAGB/T5783-M5X12	97575-08550-00	TORNILLO	SCREW	VITE	VIS	4
15	PAGB/T97.1-8	93102-20108	ARANDELA	WASHER	RONDELLA	RONDELLE	17
16	PAF15-07010014	66M-11357-00	JUNTA TAPA	GASKET, COVER	GAURNIZIONE COPERCHIO	JOINT COUVERCLE	1
17	PAF15-07000031	66M-12411-01	TERMOSTATO	THERMOSTAT	TERMOSTATO	THERMOSTAT	1
18	PAF15-07010022	62Y-12414-00	JUNTA TAPA TERMOSTATO	GASKET, THERMOSTAT COVER	GUARNIZIONE COPERCHIO TERMOSTATO	JOINT COUVERCLE DE THERMOSTAT	1
19	PAF15-07010021	6H3-12413-001S	TAPA TERMOSTATO	COVER, THERMOSTAT	COPERCHIO TERMOSTATO	COUVERCLE DE THERMOSTAT	1
20	PAGB/T5783-M5X12	90201-08818	TORNILLO	SCREW	VITE	VIS	7
21	PAF15-07010018	66M-41114-01	JUNTA EXTERIR, TAPA DE ESCAPE	GASKET, EXHAUST OUTER COVER	GUARNIZIONE ESTERIORE, COPERCHIO SCARICO	JOINT DE COUVERCLE EXT ECHAPPEMENT	1
22	PAF15-07000013	93604-12M07	PIN	OPIN	SPINOTTO	LEVIER D'ENTRAINEMENT	2
23	PAGB/T5783-M5X12	68D-E5362-00	TORNILLO	SCREW	VITE	VIS	1
24	PAF15-07010026	6E5-11325-00	ÁNODO	ANODE	ANODO	ANODE	1
25	PAF15-07010019	66M-41113-20-1S	TAPA ESCAPE COMPLETA	OUTTER COVER, EXHAUST	COPERCHIO SCARICO COMPLETA	COUVERCLE ECHAPPEMENT EXTERIEUR	1
26	PAF15-04000005	676-11372-00	NIPLE DE MANGUERA	NIPPLE	TUBO	RACCORD D'EAU	3
27	PAF15-05000012	90445-09061	TUBO	HOSE A	TUBO	DURITE D'EAU	1
28	PAF15-05000011	688-24378-00	CONECTOR DE 3 VÍAS	THREE-WAY PIPE	CONNETTORE T	TE	1
29	PAF15-05000013	90445-09086	TUBO	HOSE B	TUBO	DURITE D'EAU	1
30	PAF15-05000014	90445-09104	TUBO	HOSE C	TUBO	DURITE D'EAU	1
31	PAF15-07010003	90401-20M00	TORNILLO	SCREW	VITE	VIS	1
32	PAF15-07010023	5GH-13440-00	FILTRO ACEITE	OIL FILTER	FILTRO DELL'OLIO	FILTRE À HUILE	1
	REC5GH-13440-00	5GH-13440-00	FILTRO ACEITE	OIL FILTER	FILTRO DELL'OLIO	FILTRE À HUILE	1
33	PAF15-00000014	66M-11351-10	JUNTA BASE MOTOR	GASKET ENGINE	GUARNIZIONE BASE MOTORE	JOINT MOTEUR	1
34	PAF15-07010007	90445-10M46	TUBO	HOSE, RETURN OIL	TUBO	TUYAU	1
35	PAF15-07030000	66M-11411-00	CIGÜEÑAL	CRANK ASSY	ALBERO MOTORE	VILEBREQUIN	1
36	PAF15-07030006	93102-35M51	RETÉN DE ACEITE	OIL SEAL	PARAOLIO	JOINT D'HUILE	1
37	PAF15-07010024	66M-11416-00	COJINETE BANCADA	MAIN BEARING	CUSCINETTO	PALIER DE VILEBREQUIN	4
38	PAF15-07030007	93102-25M52	RETÉN DE ACEITE	OIL SEAL	PARAOLIO	JOINT D'HUILE	1
39	PAF15-07020100	66M-11650-00	BIELA	ROD, CONNECTING	BIELLA	BIELLE	2
40	PAF15-07020001	66M-11631-00-96	PISTÓN	PISTON	PISTONE	PISTON	2
41	PAF15-07020006	634-11633-00	BULÓN	PIN, PISTON	BULLONE	AXE DE PISTON	2
42	PAF15-07020005	93450-15023	CIRCLIP	CIRCLIP	CIRCLIP	CIRCLIP	4
43	REC66N-11603-00	66N-11603-00	KIT SEGMENTOS DE PISTÓN	PISTON RING KIT	KIT FASCIA PISTONE	KIT DE SEGMENTS	2

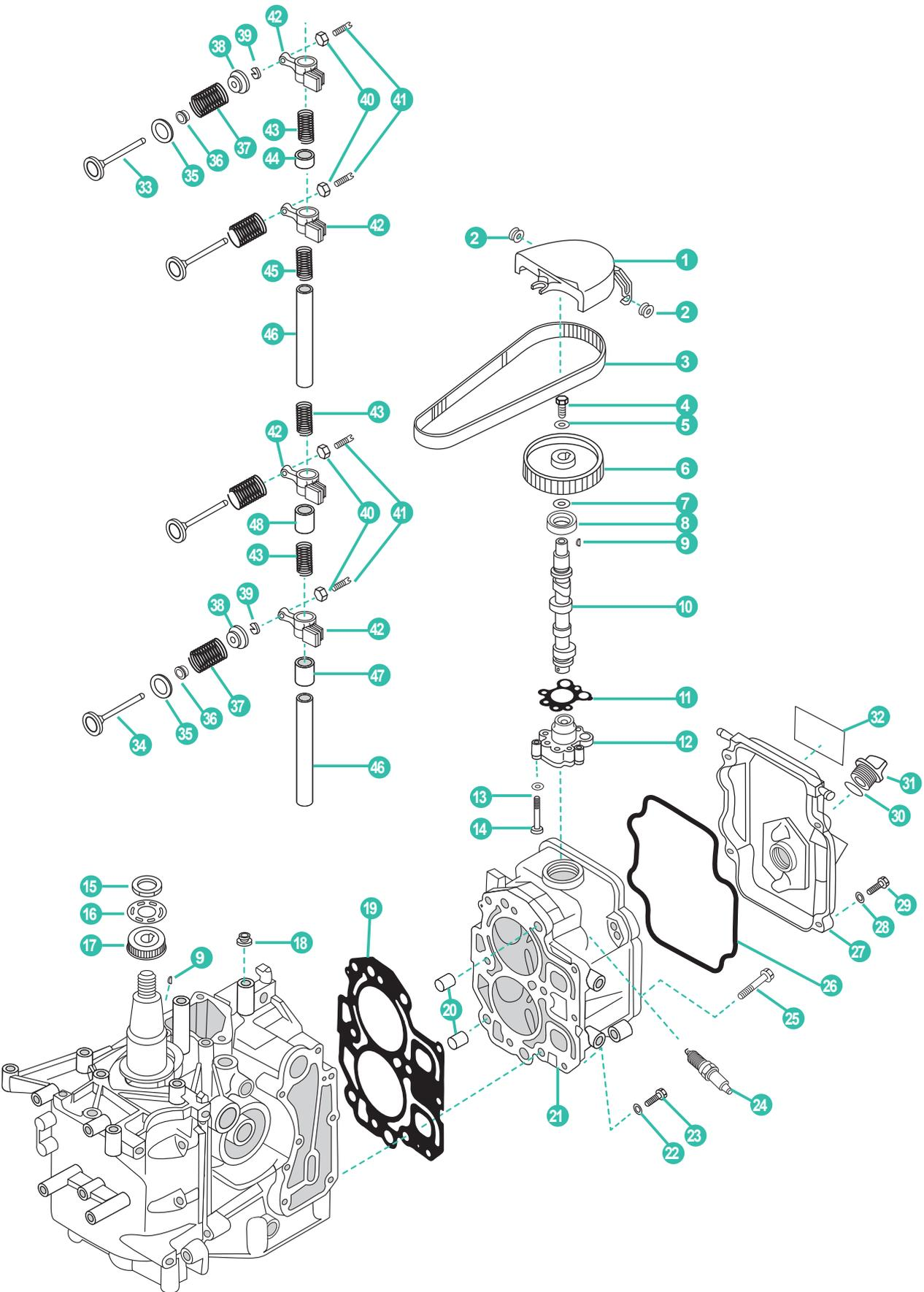

	REF	OEM					UN.
1	PAF15-07000024	66M-46297-00	TAPA	COVER, DUST	COPERCHIO	COUVERCLE	1
2	PAF15-07050003	90480-10M16	GOMA	RING RUBBER A	GOMMINO	BAGUE DE COUVERCLE	2
3	REC66M-46241-00	66M-46241-00	CORREA DISTRIBUCIÓN	BELT TIMING	CINGHIA DISTRIBUZIONE	COURROIE DISTRIBUTION	1
4	PAGB/T5783-M5X12	97013-06016	TORNILLO	BOLT	VITE	VIS	1
5	PAGB/T5287-6	90201-06M94	ARANDELA	BIG WASHER	RONDELLA	RONDELLE	1
6	PAF15-07040018	66M-11537-00-94	POLEA DE CORREA	BELT PULLEY, DRIVEN	PULEGGIA	POULIE DE COURROIE	1
7	PAF15-07040017	90201-13201	ARANDELA	WASHER	RONDELLA	RONDELLE	1
8	PAF15-07040008	93102-18M21	RETÉN DE ACEITE	OIL SEAL	PARAOLIO	JOINT D'HUILE	1
9	PAGB/T1099-3X5X13	90280-03M01	CHAVETA	KEY, WOODRUFF	CHIAVETTA	CLAVETTE	2
10	PAF15-07040200	66M-12170-00	ÁRBOL DE LEVAS	CAMSHAFT ASSY	ALBERO A CAMME	ARBRE À CAMES	1
11	PAF15-07040016	66M-13329-10	JUNTA	MAT, AIRPROOF	GUARNIZIONE	JOINT	1
12	PAF15-07040500	66M-13300-10	BOMBA ACEITE	OIL PUMP ASSY	POMPA DELL'OLIO	POMPE À HUILE	1
13	PAGB/T97.1-8	92995-06600	ARANDELA	WASHER	RONDELLA	RONDELLE	3
14	PAGB/T5783-M5X12	97095-06035	TORNILLO	BOLT	VITE	VIS	3
15	PAF15-07030005	90170-28M37	TUERCA	NUT	GHIERA	ÉCROU	1
16	PAF15-07030004	66M-11557-00	ARANDELA	WASHER	RONDELLA	RONDELLE	1
17	PAF15-07030003	66M-11536-10	POLEA DENTADA	BELT PULLEY, TIMING	PULEGGIA	POULIE	1
18	PAF15-07010027	90480-12072	GOMA	RUBBER RING	GOMMINO	BAGUE DE COUVERCLE	1
19	PAF15-07000100	66M-11181-10	JUNTA CULATA	GASKET, CYLINDER HEAD	GUARNIZIONE TESTATA	JOINT DE CULASSE	1
20	PAF15-07000001	99510-10114	PIN CENTRADOR	HOLLOW PIN	SPINOTTO DI CENTRAGGIO	PIN DE CENTRAGE	2
21	PAF15-07040000	66M-11111-01-1S	CULATA	CYLINDER HEAD ASSY	TESTATA	CULASSE	1
22	PAGB/T97.1-6	92990-06600	ARANDELA	WASHER	RONDELLA	RONDELLE	3
23	PAGB/T5783-M6X25	97513-06525	TORNILLO	BOLT	VITE	VIS	3
24	NGK DPR7EA-9	94701-00375	BUJÍA	SPARK PLUG	CANDELA	BOUGIE	2
25	PAF15-07000028	90105-08M78	TORNILLO	BOLT, FLANGE	VITE	VIS	6
26	PAF15-07050002	66M-11356-00	JUNTA TAPA	SEAL, CYLINDER COVER	GAURNIZIONE COPERCHIO	JOINT COUVERCLE	1
27	PAF15-07050001	66M-11191-00-1S	TAPA BALANCINES	COVER, CYLINDER HEAD	COPERCHIO PUNTERIE	CACHE CULBUTEUR	1
28	PAGB/T5783-M5X12	92995-06600	ARANDELA	WASHER, PLATE	RONDELLA	RONDELLE	7
29	PAGB/T5783-M6X20	97595-06520	TORNILLO	BOLT	VITE	VIS	4
30	PAF4-04000008	93210-24M79	TÓRICA	O-RING	O-RING	TORIQUE	1
31	PAF15-07050004	6G8-15363-00	TAPÓN ACEITE	PLUG, OIL	TAPPO OLIO	BOUCHON REMPLISSAGE D'HUILE	1
32	PAF15-10030001	66M-12138-60	ADHESIVO 4	MARK 4	ADESIVO 4	AUTOCOLLANT 4	1
33	PAF15-07040001	66M-12111-00	VÁLVULA ADMISIÓN	VALVE, INTAKE	VALVOLA ASPIRAZIONE	SOUPAPE D ADMISSION	2
34	PAF15-07040002	66M-12121-00	VÁLVULA ESCAPE	VALVE, EXHAUST	VALVOLA SCARICO	SOUPAPE D'ÉCHAPPEMENT	2
35	PAF15-07040004	66M-12116-00	ARANDELA DE ASIENTO	SEAT, VALVE SPRING	RONDELLA BASAMENTO	SIEGE RESSORT DE SOUPAPE	4
36	PAPS2700.04.03	51Y-12119-00	RETÉN	SEAL, VALVESTEM	GUARNIZIONE	JOINT D'HUILE	4
37	PAF15-07040005	66M-12113-00	MUELLE	SPRING, VALVE	MOLLA	RESSORT	4
38	PAF15-07050006	30X-12117-00	RETÉN RESORTE	SPRING, VALVE RETAINER	VALVOLA DI RITEGNO	JOINT DE RESSORT	4
39	PAF15-07040007	30X-12118-00	SEGURO DE VÁLVULA	CLAMP, VALVE	BLOCCAGGIO DI VALVOLA	CLAVETTE DE SOUPAPE	8
40	PAF15-07040304	62Y-12158-00	TUERCA	LOCK NUT	DADO	ÉCROU	4
41	PAF15-07040303	62Y-12159-00	TORNILLO REGULADOR	SCREW, VALVE ADJUSTING	VITE REGOLATORE	VIS POINTEAU	4
42	PAF15-07040301	66M-12151-10	BALANCÍN	VALVE ROCKER	BILANCERE	CULBUTEUR	4
43	PAF15-07040014	90501-12M40	MUELLE	SPRING, ROCKER	MOLLA	RESSORT	3
44	PAF15-07040009	90387-13001	CASQUILLO	BUSHER	GOMMINO	DOUILLE	1
45	PAF15-07040013	90501-12M41	MUELLE	SPRING, ROCKER A	MOLLA	RESSORT	1
46	PAF15-07040015	66M-12146-00	EJE DE BALANCÍN	SHAFT, ROCKER	ASSE BILANCERE	AXE DE CULBUTEUR	2
47	PAF15-07040012	90387-13M56	CASQUILLO B	BUSHER B	GOMMINO B	BAGUE B	1
48	PAF15-07040011	90387-13002	CASQUILLO A	BUSHER A	GOMMINO A	BAGUE A	1
49	PAF15-07000000	66M-W009B-15-1S	MOTOR COMPLETO	POWER HEAD COMPLETE	MOTORE COMPLETO	MOTEUR COMPLET	1

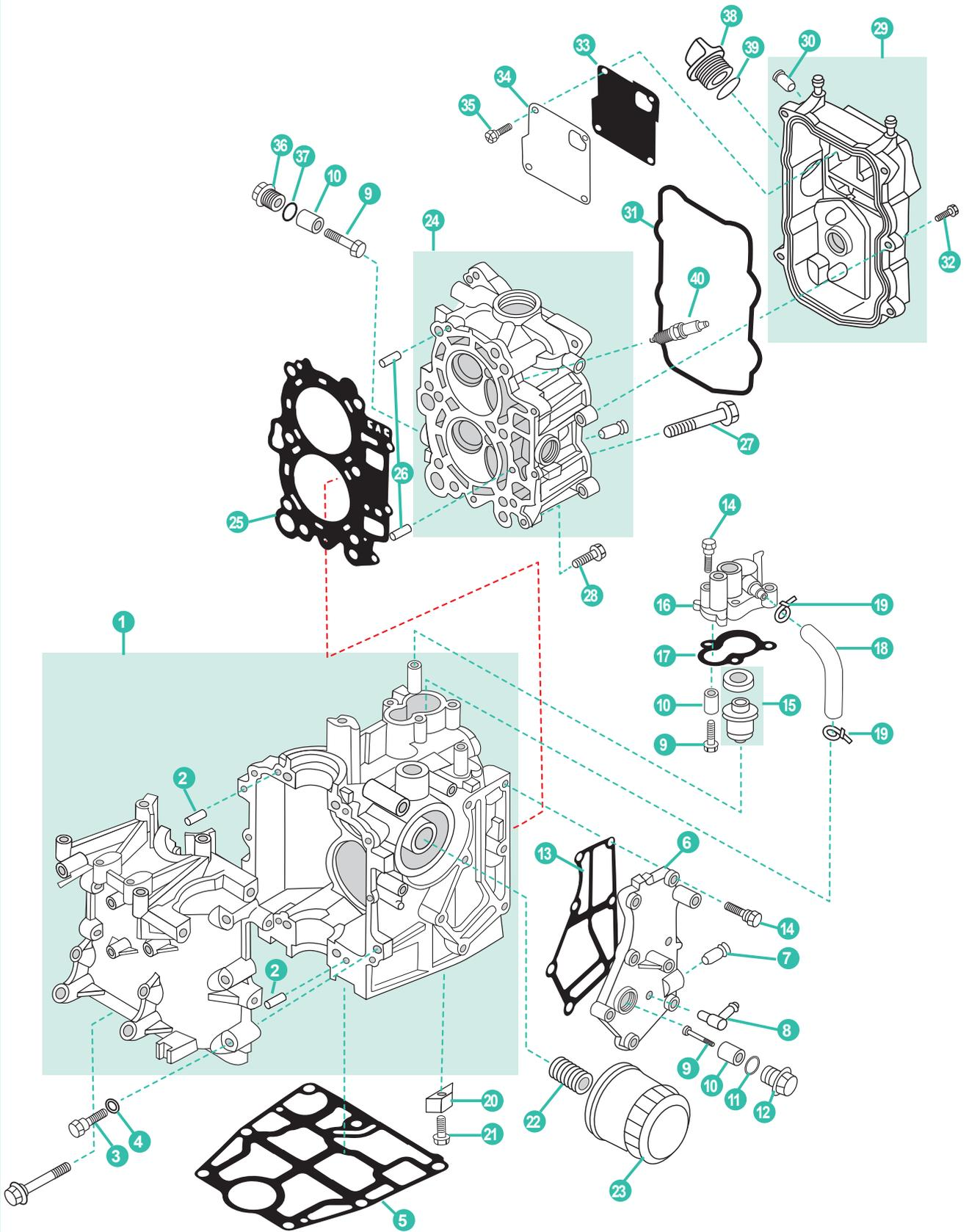

	REF	OEM				UN.	
1	PAF20-05010000	6AH-15100-00	CÁRTER COMPLETO	CRANKCASE ASSY	CARTER COMPLETO	CARTER BLOC MOTEUR	1
2	REC93606-12019	93606-12019	PIN CENTRADOR	HOLLOW PIN	SPINOTTO DI CENTRAGGIO	PIN DE CENTRAGE	4
3	PAF20-05010007	97013-06040	PERNO	BOLT	BULLONE	BOULON	6
4	PAGB/T97.1-6	92903-06600	ARANDELA	WASHER	RONDELLA	RONDELLE	6
5	REC6AH-11351-00	6AH-11351-10	JUNTA DE ESCAPE	EXHAUST GASKET	GUARNIZIONE DI SCARICO	JOINT D'ÉCHAPPEMENT	1
6	PAF20-05000600	6AH-41113-01-1S	CUBIERTA DE ESCAPE	EXHAUST COVER	COPERCHIO SCARICO	COUVERCLE D'ÉCHAPPEMENT	1
7	PAF4-04010102	6E9-24378-00	PIPA DE AGUA	PIPE, WATER	TUBO	RACCORD TUYAU D'EAU	1
8	PAF15-04000005	6H1-11372-00	NIPLE DE MANGUERA	NIPPLE	TUBO	RACCORD D'EAU	1
9	PAGB/T818-M5X25	98980-05025	TORNILLO	SCREW	VITE	VIS	4
10	CM6G8-11325-00A	6G8-11325-00	ÁNODO	ANODE	ANODO	ANODE	4
11	PAGB/T3452.1-13X2	93210-13M63	ANILLO	O-RING	O-RING	TORIQUE	1
12	PAF20-05030009	6G8-11197-A0	TAPÓN	CAP	TAPPO	BOUCHON	1
13	PAF20-05000602	6AH-41114-00	JUNTA DE ESCAPE	EXHAUST GASKET	GUARNIZIONE DI SCARICO	JOINT D'ÉCHAPPEMENT	1
14	PAGB/T5783-M6X25	90119-06MA3	TORNILLO	SCREW	VITE	VIS	3
15	REC6AH-12411-00	6AH-12411-00	TERMOSTATO	THERMOSTAT	TERMOSTATO	THERMOSTAT	1
16	PAF20-05000700	6AH-12413-00-1S	TAPA TERMOSTATO	COVER, THERMOSTAT	COPERCHIO TERMOSTATO	COUVERCLE DE THERMOSTAT	1
17	PAF20-05000702	6AH-12414-00	JUNTA	GASKET	GUARNIZIONE	JOINT	1
18	PAF20-05000016	6AH-12481-00	TUBO DE AGUA	WATER TUBE	TUBO DELL'ACQUA	DURITE D'EAU	1
19	PAHT2.5X50	90465-11M10	BRIDA	CLAMP	FLANGIA	COLLIER	2
20	CM15026A	6E5-11325-00	ÁNODO	ANODE	ANODO	ANODE	1
21	PAGB/T820-M4X12	98780-04016	TORNILLO	SCREW	VITE	VIS	1
22	PAF15-07010003	6C5-12858-00	PERNO	STUD	BULLONE	BOULON	1
23	REC5GH-13440-60	5GH-13440-60	FILTRO ACEITE	OIL FILTER	FILTRO DELL'OLIO	FILTRE À HUILE	1
24	PAF20-05030100	6AH-11111-10-1S	CULATA	CYLINDER HEAD	TESTATA	CULASSE	1
25	REC6AG-11181-00	6AG-11181-10	JUNTA CULATA	GASKET, CYLINDER HEAD	GUARNIZIONE TESTATA	JOINT DE CULASSE	1
26	REC93606-12019	93606-12019	PIN CENTRADOR	HOLLOW PIN	SPINOTTO DI CENTRAGGIO	PIN DE CENTRAGE	2
27	PAF20-05000002	90105-090006	TORNILLO	SCREW	VITE	VIS	6
28	PAF8-05000022	90119-06MA3	TORNILLO	SCREW	VITE	VIS	3
29	PAF20-05040000	6AH-11191-001S	TAPA DE CULATA COMPLETA	CYLINDER HEAD COVER ASSY	COPERCHIO TESTATA COMPLETA	CACHE CULBUTEUR COMPLÈTE	1
30	PAF20-05040005	6AH-11372-00	NIPLE DE MANGUERA	NIPPLE	TUBO	RACCORD D'EAU	1
31	PAF20-05040002	6AH-11356-00	RETÉN DE ACEITE	OIL SEAL	PARAOLIO	JOINT D'HUILE	1
32	PAGB/T5783-M6X20	97595-06520	PERNO	STUD	BULLONE	BOULON	5
33	PAF20-05040003	6AH-11168-00	CUBIERTA DE RESPIRADERO	COVER, BREATHER	COPERCHIO	PLAQUE	1
34	PAF20-05040004	6AH-11169-00	JUNTA DE CUBIERTA	GASKET, BREATHER	GUARNIZIONE COPERCHIO	JOINT DE PLAQUE	1
35	PAGB/T818-M4X10	97607-04210	TORNILLO	SCREW	VITE	VIS	4
36	PAF20-05030009	6G8-11197-A0	TAPÓN	CAP	TAPPO	BOUCHON	2
37	PAGB/T3452.1-13X2	93210-13M63	ANILLO	O-RING	O-RING	TORIQUE	2
38	PAF15-07050004	6G8-15363-00	TAPÓN DE ACEITE	OIL CAP	TAPPO OLIO	BOUCHON REMPLISSAGE D'HUILE	1
39	PAJASOF40431-025	93210-24M79	ANILLO	O-RING	O-RING	TORIQUE	1
40	NGKDPR6EB-9	94702-00418	BUJÍA	SPARK PLUG	CANDELA	BOUGIE	2



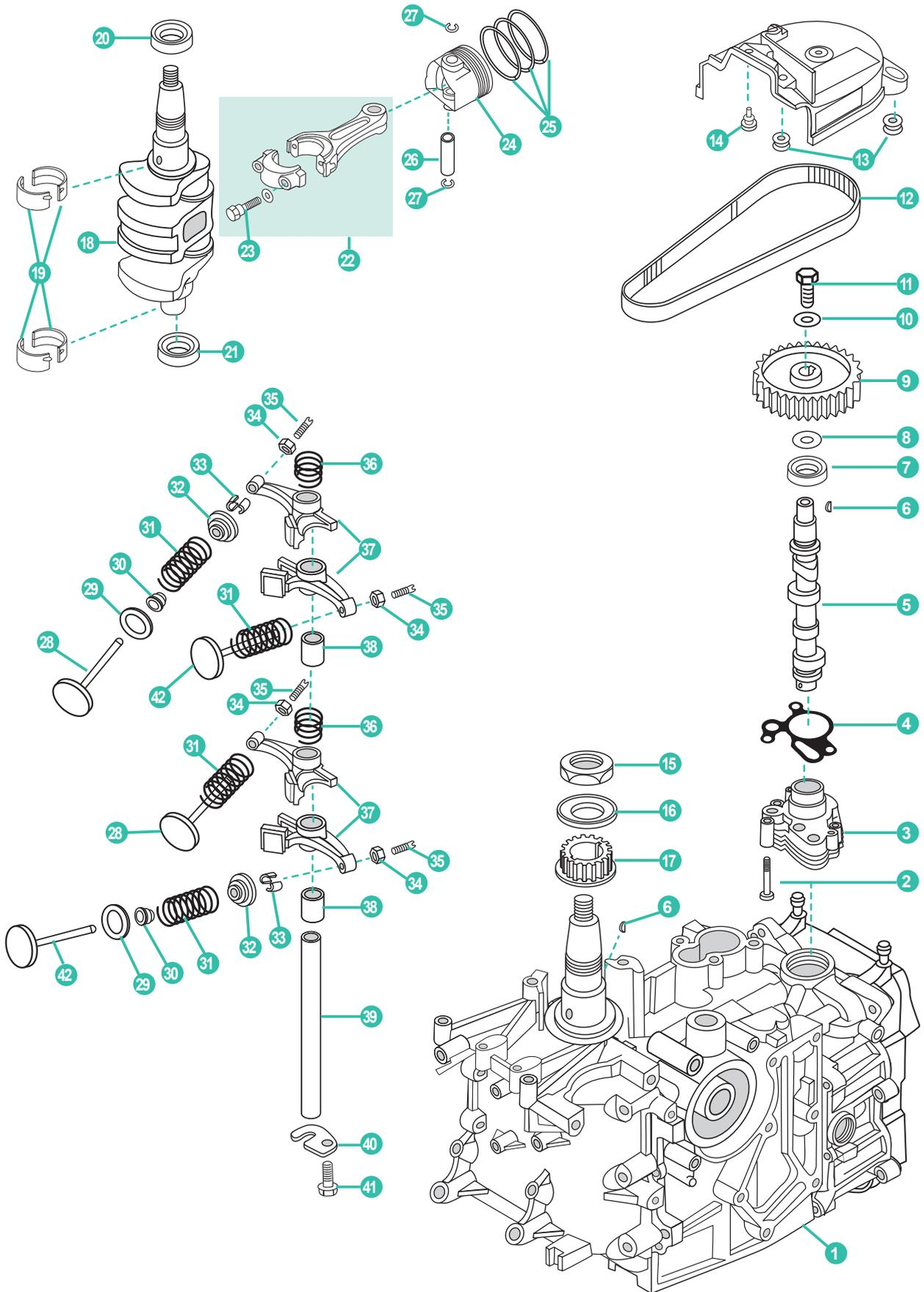

	REF	OEM				UN.	
1	PAF20-0500000	6AH-W009B-02-15	CILINDRO BLOQUE COMPLETO	POWER HEAD ASSY	BLOCCO COMPLETO	TÊTE MOTRICE	1
2	PAGB/T5783-M6X35	90105-06035	TORNILLO	SCREW	VITE	VIS	3
3	PAF20-05030400	6AH-13300-00	BOMBA DE ACEITE	OIL PUMP	POMPA DELL'OLIO	POMPE À HUILE	1
4	PAF20-05030010	6AH-13329-10	JUNTA TAPA	GASKET, COVER	GAURNIZIONE COPERCHIO	JOINT COUVERCLE	1
5	PAF20-05030200	6AH-12170-00	ÁRBOL DE LEVAS	CAMSHAFT ASSY	ALBERO A CAMME	ARBRE À CAMES	1
6	PAGB/T1099-3X5X13	90280-03M01	CUÑA	KEY WOODRUFF	CHIAVETTA	CLAVETTE	2
7	PAF20-05030005	93102-22010	RETÉN DE ACEITE	OIL SEAL	PARAOLIO	JOINT D'HUILE	1
8	PAF20-05030011	90201-15423	ARANDELA	WASHER	RONDELLA	RONDELLE	1
9	PAF20-05030012	6AH-11537-00	POLEA DE CORREA	BELT PULLEY, DRIVEN	PULEGGIA CINGHIA	POULIE DE COURROIE	1
10	PAF20-05030013	90201-08784	ARANDELA	WASHER	RONDELLA	RONDELLE	1
11	PAGB/T5783-M8X25	90105-081A7	TORNILLO	SCREW	VITE	VIS	1
12	PAF20-05000003	6AH-46241-00	CORREA	BELT	CINGHIA	COURROIE	1
13	PAF20-05000034	90480-10627	TAPÓN	CAP	TAPPO	BOUCHON	3
14	PAF20-05000036	90480-06M19	TAPÓN	CAP	TAPPO	BOUCHON	1
15	PAF20-05000029	90170-30003	TUERCA	NUT	DADO	ÉCROU	1
16	PAF20-05000028	6AH-11557-00	ARANDELA	WASHER	RONDELLA	RONDELLE	1
17	PAF20-05000027	6AH-11536-00	ENGRANAJE DE DISTRIBUCIÓN	BELT PULLEY, TIMING	PULEGGIA DE DISTRIBUZIONE	POULIE DE DISTRIBUTION	1
18	PAF20-05020004	6AH-11411-00	CIGÜEÑAL	CRANK ASSY	ALBERO MOTORE	VILEBREQUIN	1
19	PAF20-05010003	6AH-11416-00	COJINETE BANCADA	MAIN BEARING	CUSCINETTO	PALIER DE VILEBREQUIN	1
20	PAF25-05050021	93102-37004	RETÉN DE ACEITE	OIL SEAL	PARAOLIO	JOINT D'HUILE	1
21	PAF15-07030006	93102-25014	RETÉN DE ACEITE	OIL SEAL	PARAOLIO	JOINT D'HUILE	1
22	PAF20-05020200	6AH-11650-10	BIELA	ROD, CONNECTING	BIELLA	BIELLE	2
23	PAF25-05020204	6AH-11654-00	TORNILLO	SCREW	VITE	VIS	2
24	PAF20-05020001	6AH-11631-00	PISTÓN STD	PISTON STD	PISTONE STD	PISTON STD	2
25	PAF20-05020100	6AH-11603-00	KIT SEGMENTOS DE PISTÓN STD	PISTON RING KIT STD	KIT FASCIA PISTONE STD	KIT SEGMENTS STD	2
26	PAF20-05020003	137-11633-10	PIN, PISTÓN	PIN, PISTON	SPINOTTO PISTONE	AXE DE PISTON	2
27	PAF20-05020002	93450-17129	CIRCLIP	CIRCLIP	CIRCLIP	CIRCLIP	4
28	PAF20-05030001	6AH-12111-00	VÁLVULA ADMISIÓN	VALVE, INTAKE	VALVOLA ASPIRAZIONE	SOUPAPE D ADMISSION	2
29	PAF20-05030003	62Y-12116-00	ARANDELA DE ASIENTO	SEAT, VALVE SPRING	RONDELLA BASAMENTO	SIEGE RESSORT DE SOUPAPE	4
30	PA166F-010003	51Y-12119-00	RETÉN DE ACEITE	OIL SEAL	PARAOLIO	JOINT D'HUILE	4
31	PAF20-05030004	3YF-12113-00	MUELLE DE VÁLVULA	SPRING, VALVE STEM	MOLLA DI VALVOLA	RESSORT DE SOUPAPE	4
32	PAF15-07040006	30X-12117-00	RETÉN RESORTE	SPRING, VALVE RETAINER	VALVOLA DI RITEGNO	JOINT DE RESSORT	4
33	PAF15-07040007	30X-12118-00	SEGURO DE VÁLVULA	CLAMP, VALVE	BLOCCAGGIO DI VALVOLA	CLAVETTE DE SOUPAPE	8
34	PAF15-07040304	62Y-12158-00	TUERCA	LOCK NUT	DADO	ÉCROU	4
35	PAF15-07040303	64J-12159-00	TORNILLO REGULADOR	SCREW, VALVE ADJUSTING	VITE REGOLATORE	VIS POINTEAU	4
36	PAF20-05030007	90501-120A5	RESORTE DE COMPRESIÓN	SPRING, ROCKER	MOLLA	RESSORT ROCKER	2
37	PAF20-05030301	6AH-12151-00	BRAZO DE BALANCÍN	ARM, VALVE ROCKER	BILANCERE	CULBUTEUR	4
38	PAF20-05030006	90387-13006	ESPACIADOR	COLLAR	DISTANZIALE	ENTRETOISE	2
39	PAF15-07040015	66M-12146-00	EJE DE BALANCÍN	SHAFT, ROCKER	ASSE DE BILANCERE	AXE DE CULBUTEUR	1
40	PAF20-05030008	6AH-12279-00	PLACA	PLATE	PIASTRA	PLAQUE	1
41	PAGB/T5783-M6X12	97013-06012	TORNILLO	SCREW	VITE	VIS	1
42	PAF20-05030002	6AH-12121-10	VÁLVULA ESCAPE	VALVE, EXHAUST	VALVOLA SCARICO	SOUPAPE D'ECHAPPEMENT	2

4T FT • F20 • F25 (1998-08)  
STROKES



P 95

REF	OEM
REC8542561	65W-W0093-02

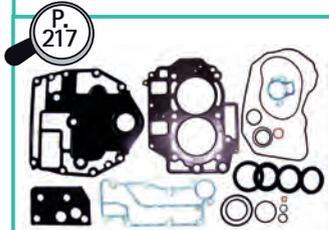
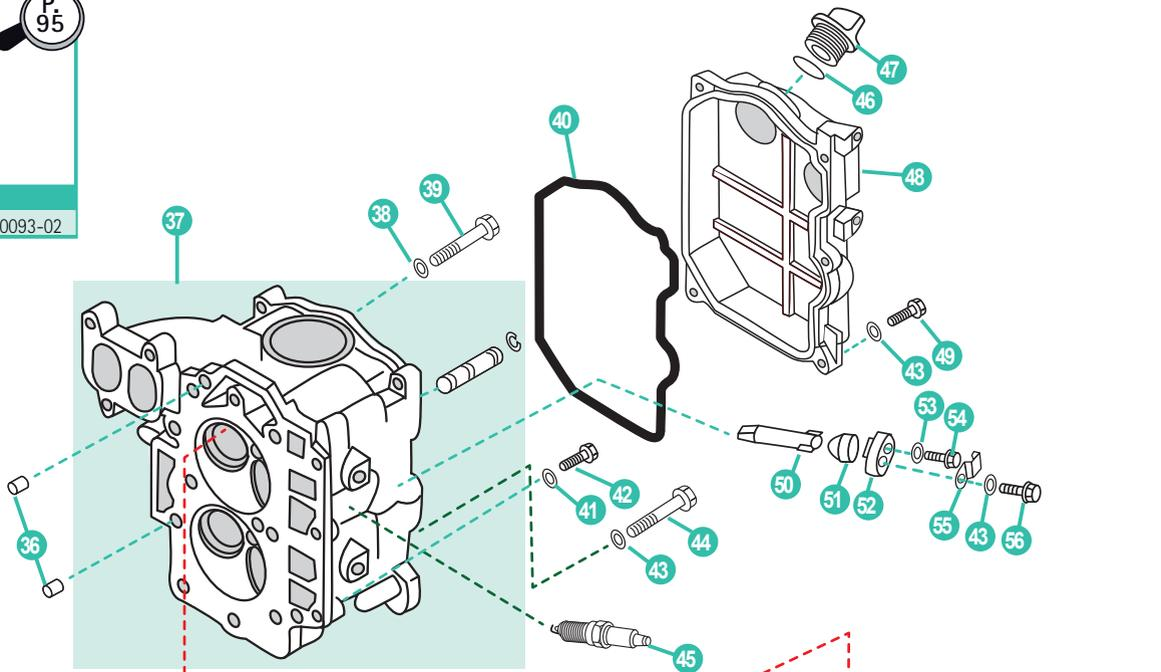

P 217

REF	OEM
REC65W-W0001-00	65W-W0001-02

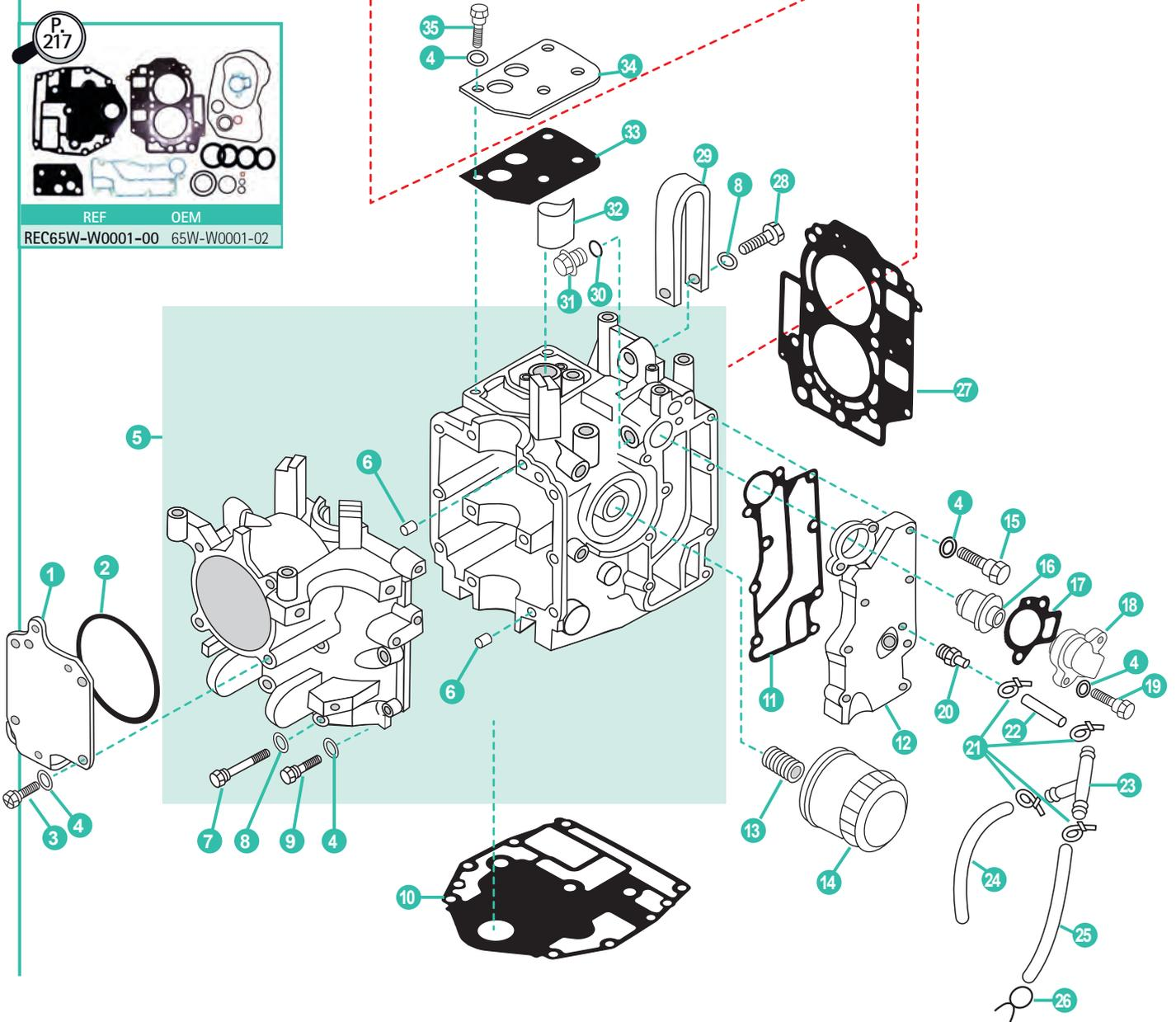



	REF	OEM				UN.	
1	PAF25-05000007	65W-15121-00	TAPA	COVER	COPERCHIO	COUVERCLE	1
2	PAGBT3452.1-97.5X1.8	65W-15663-00	JUNTA	SEAL	GUARNIZIONE	JOINT	1
3	PAGB/T5783-M6X20	65W-12228-00	TORNILLO	BOLT, HEXAGON	VITE	VIS	4
4	PAGB/T97.1-8	66M-11356-00	ARANDELA	WASHER 6	RONDELLA	RONDELLE	17
5	PAF25-05010000	65W-15100-00-94	BLOQUE MOTOR COMPLETO	CRANKCASE ASSY	BLOCCO MOTORE COMPLETO	CARTER BLOC MOTEUR	1
6	PAF25-00000014	99530-08012	PIN CENTRADOR	HOLLOW PIN	SPINOTTO DI CENTRAGGIO	PIN DE CENTRAGE	2
7	PAGB/T5782-M8X80	90119-08M01	TORNILLO	BOLT, HEXAGON	VITE	VIS	6
8	PAGB/T97.1-8	97595-06520	ARANDELA	WASHER	RONDELLA	RONDELLE	7
9	PAGB/T5782-M6X35	90119-06MA5	TORNILLO	BOLT, HEXAGON	VITE	VIS	6
10	PAF25-00000013	65W-11351-00	JUNTA BASE MOTOR	GASKET ENGINE	GUARNIZIONE BASE MOTORE	JOINT MOTEUR	1
11	PAF25-05010111	65W-41114-00	JUNTA EXTERIOR, TAPA DE ESCAPE	GASKET, EXHAUST OUTER COVER	GUARNIZIONE ESTERIORE, COPERCHIO SCARICO	JOINT DE COUVERCLE EXT ECHAPPEMENT	1
12	PAF25-05010112	65W-41113-01-94	TAPA EXTERIOR DE ESCAPE	OUTTER COVER, EXHAUST	COPERCHIO SCARICO	COUVERCLE D'ECHAPPEMENT	1
13	PAF15-07010003	90401-20M00	TORNILLO	BOLT, UNION	VITE	VIS	1
14	PAF25-05000100	5GH-13440-00	FILTRO ACEITE	OIL FILTER	FILTRO DELL'OLIO	FILTRE À HUILE	1
14	REC5GH-13440-00	5GH-13440-00	FILTRO ACEITE	OIL FILTER	FILTRO DELL'OLIO	FILTRE À HUILE	1
15	PAGB/T5783-M6X35	90119-06MAS	TORNILLO	BOLT	VITE	VIS	7
16	PAF15-07000031	6G8-12411-02	TERMOSTATO	THERMOSTAT	TERMOSTATO	THERMOSTAT	1
17	PAF15-07010022	62Y-12414-00	JUNTA TAPA TERMOSTATO	GASKET, THERMOSTAT COVER	GUARNIZIONE COPERCHIO TERMOSTATO	JOINT COUVERCLE DE THERMOSTAT	1
18	PAF15-07010021	6H3-12413-00-9M	TAPA TERMOSTATO	COVER, THERMOSTAT	COPERCHIO TERMOSTATO	COUVERCLE DE THERMOSTAT	1
19	PAGB/T5783-M6X25	90119-06MA5	TORNILLO	BOLT	VITE	VIS	2
20	PAF25-05010113	62Y-11372-01	NIPLE DE MANGUERA	NIPPLE	TUBO	RACCORD D'EAU	1
21	PAHT-2.5x60	90465-11M10	BRIDA	CLAMP	FLANGIA	COLLIER	5
22	PAF25-03000008	90445-09068	TUBO DE AGUA	WATER TUBE	TUBO DELL'ACQUA	DURITE D'EAU	1
23	PAF15-05000011	688-24378-00	CONECTOR DE 3 VÍAS	THREE-WAY PIPE	CONNETTORE T	TE	1
24	PAF25-03000009	90445-09095	TUBO DE AGUA	WATER TUBE	TUBO DELL'ACQUA	DURITE D'EAU	1
25	PAF25-03000011	90445-09105	TUBO DE AGUA	WATER TUBE	TUBO DELL'ACQUA	DURITE D'EAU	1
26	PAF4-04000030	90467-09M09	MUELLE TUBO COMBUSTIBLE B	SPRING, FUEL PIPE B	MOLLA TUBO COMBUSTIBILE B	RESSORT, TUYAU DE CARBURANT	1
27	PAF25-05040000	65W-11181-30	JUNTA CULATA	GASKET, CYLINDER HEAD	GUARNIZIONE TESTATA	JOINT DE CULASSE	1
28	PAGB/T5782-M8X35	65W-08M87	TORNILLO	BOLT, HEXAGON	VITE	VIS	1
29	PAF25-05010106	66W-11119-00	SOPORTE	HANGER, ENGINE	SUPPORTO	CROCHET LEVAGE MOTEUR	1
30	PAF15-04000003	90430-14M09	ARANDELA	WASHER	RONDELLA	RONDELLE	1
31	PAF15-04000002	90340-14M06	TORNILLO DRENAJE	BOLT, DISCHARGING OIL	VITE DRENAGGIO	VIS DE VIDANGE	1
32	PAF25-05010107	65W-13286-00	FILTRO ACEITE	OIL FILTER	FILTRO DELL'OLIO	FILTRE À HUILE	1
33	PAF25-05010108	65W-11169-00	JUNTA DE CUBIERTA	GASKET, BREATHER	GUARNIZIONE COPERCHIO	JOINT DE PLAQUE	1
34	PAF25-05010103	65W-11168-00	CUBIERTA DE RESPIRADERO	COVER, BREATHER	COPERCHIO	PLAQUE	1
35	PAGB/T5783-M6X20	65W-12228-00	TORNILLO	BOLT, HEXAGON	VITE	VIS	4
36	PAF25-00000014	99530-08012	PIN CENTRADOR	HOLLOW PIN	SPINOTTO DI CENTRAGGIO	PIN DE CENTRAGE	2
37	PAF25-05050100	65W-11111-02-94	CULATA	CYLINDER HEAD	TESTATA	CULASSE	1
38	PAF25-05050007	90430-06014	JUNTA	GASKET	GUARNIZIONE	JOINT	1
39	PAF25-05050006	90109-06M65	TORNILLO	BOLT	VITE	VIS	1
40	PAF25-05000004	65W-11356-00	JUNTA TAPA	GASKET, COVER	GAURNIZIONE COPERCHIO	JOINT COUVERCLE	1
41	PAGB/T97.1-8	97595-06520	ARANDELA	WASHER, PLATE	RONDELLA	RONDELLE	10
42	PAGB/T5783-M6X25	90119-06MA3	TORNILLO	BOLT, HEXAGON	VITE	VIS	6
43	PAF25-05000003		ARANDELA	WASHER, PLATE	RONDELLA	RONDELLE	10
44	PAF25-05000002	90119-09M00	TORNILLO	BOLT, FLANGE	VITE	VIS	9
45	NGKDPR7EA-9	94701-00375	BUJÍA	SPARK-PLUG	CANDELA	BOUGIE	2
46	PAJASOF40431-025	93210-24M79	TÓRICA	O-RING	O-RING	TORIQUE	1
47	PAF15-07050004	6G8-15363-00	TAPÓN ACEITE	PLUG, OIL	TAPPO OLIO	BOUCHON REMPLISSAGE D'HUILE	1
48	PAF25-05000005	65W-11191-00-94	TAPA BALANCINES	COVER, CYLINDER HEAD	COPERCHIO PUNTERIE	CACHE CULBUTEUR	1
49	PAGB/T5783-M6X20	90119-06MA3	TORNILLO	BOLT, HEXAGON	VITE	VIS	5
50	PAF25-02010005	62Y-11325-00	ÁNODO	ANODE	ANODO	ANODE	2
51	PAF15-07010009	66M-11328-00	ALOJAMIENTO ÁNODO	GROMMET, ANODE	ALLOGGIAMENTO ANODO	JOINT D'ANODE	2
52	PAF15-07010011	66M-11327-00-94	TAPA	COVER, ANODE	COPERTURA ANODO	COUVERCLE DU ANODE	2
53	PAGB/T97.1-5	92995-05600	ARANDELA	WASHER, PLATE	RONDELLA	RONDELLE	2
54	PAGB/T5783-M5X12	97095-05012	TORNILLO	BOLT, HEXAGON	VITE	VIS	2
55	PAF15-07010012	66M-12535-00	PLETINA	PLATE, ANODE	PIASTRA ANODO	PLAQUE	2
56	PAGB/T5783-M6X20	97095-06020	TORNILLO	BOLT, HEXAGON	VITE	VIS	2

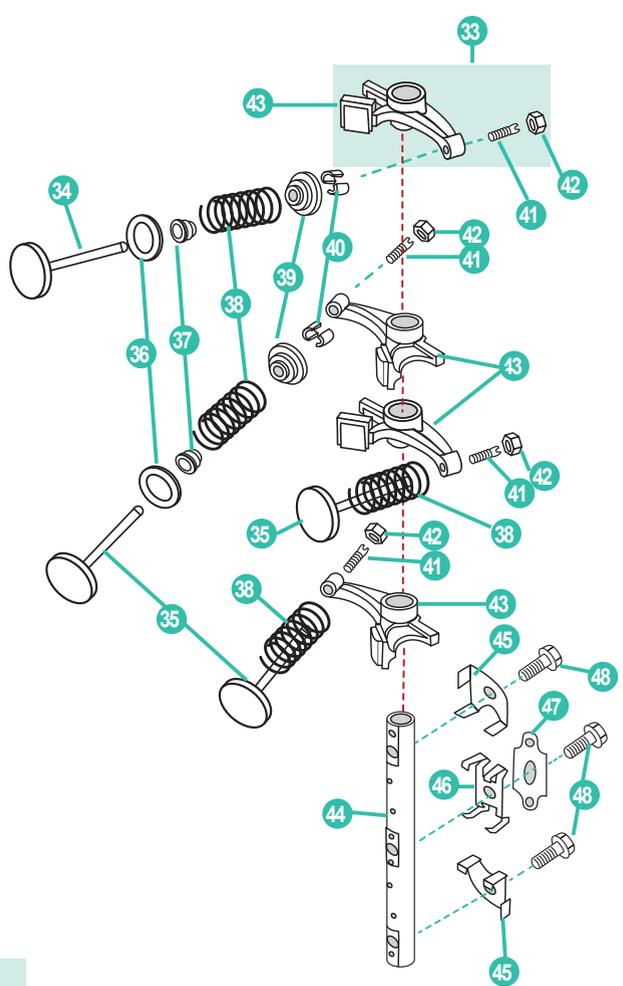
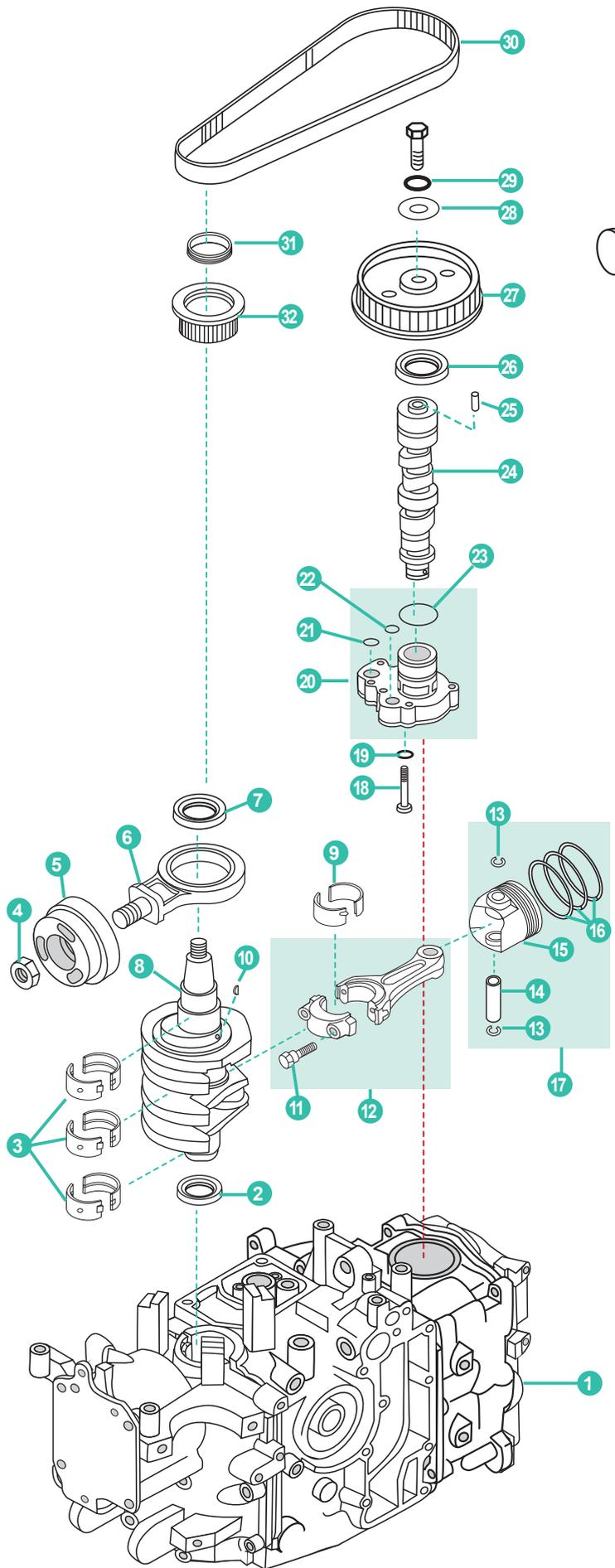

	REF	OEM				UN.	
1	POWERHEAD20-25		MOTOR	COMPLETE, POWER	BLOCCO COMPLETO	TÊTE MOTRICE	1
2	PAF25-05020002	93102-35M47	RETÉN	OIL-SEAL	GUARNIZIONE	JOINT D'HUILE	1
3	PAF25-05010302-1	62Y-11416-00	COJINETE BANCADA BROWN	MAIN BEARING BROWN	CUSCINETTO BROWN	PALIER DE VILEBREQUIN BROWN	6
3	PAF25-05010302-2	62Y-11416-10	COJINETE BANCADA BLACK	MAIN BEARING BLACK	CUSCINETTO BLACK	PALIER DE VILEBREQUIN BLACK	6
4	PAF25-05000026	90170-35M47	TUERCA	LOCK NUT	DADO	ÉCROU	1
5	PAF25-05020301	65W-11642-11	PISTÓN, CONTRA	PISTON, BALANCE	PISTONE, CONTRO	PISTON D'EQUILIBRAGE	1
6	PAF25-05020310	65W-11665-00	BIELA, CONTRO	CON-ROD ASSY, BALANCE	BIELLA, CONTRO	BIELLE D'EQUILIBRAGE	1
7	PAF25-05020003	93102-43M42	RETÉN	OIL SEAL	PARAOLIO	JOINT SPI	1
8	PAF25-05020001	65W-11411-01	CIGÜEÑAL	CRANK ASSY	ALBERO MOTORE	VILEBREQUIN	1
9	PAF25-05020203-1	62Y-11656-00	COJINETE BIELA	BEARING, CONNECTING ROD	CUSCINETTO BIELLA	PALIER DE BIELLE	2
9	PAF25-05020203-2	62Y-11656-00	COJINETE BIELA	BEARING, CONNECTING ROD	CUSCINETTO BIELLA	PALIER DE BIELLE	2
10	PAF4-04000019	90280-04M06	CUÑA	KEY WOODRUFF	CHIAVETTA	CLAVETTE	1
11	PAF25-05020204	62Y-11654-00	TORNILLO	BOLT, CONNECTING ROD	VITE	VIS	2
12	PAF25-05020200	67C-11650-00	BIELA	CONNECTING ROD	BIELLA	BIELLE	2
13	PAF25-05020106	93450-17129	CLIP	CIRCLIP	CLIP	CIRCLIP	4
14	PAF25-05020105	62Y-11633-00	PIN, PISTÓN	PIN, PISTON	SPINOTTO PISTONE	AXE DE PISTON	2
15	PAF25-05020101	65W-11631-00-96	PISTÓN	PISTON	PISTONE	PISTON	2
16	REC67C-11603-00	67C-11603-00	KIT SEGMENTOS DE PISTÓN	PISTON RING KIT	KIT FASCIA PISTONE	KIT SEGMENTS	2
17	PAF25-05020100	65W-11631-00-96	PISTÓN COMPLETO	PISTON ASSY	PISTONE COMPLETO	PISTON COMPLÈTE	2
18	PAGB/T5782-M6X125	97013-06035	TORNILLO	BOLT	VITE	VIS	4
19	PAGB/T97.1-8	66M-11328-00	ARANDELA	WASHER, PLATE	RONDELLA	RONDELLE	4
20	PAF25-05050400	65W-13300-00	BOMBA ACEITE COMPLETA	OIL PUMP ASSY	POMPA DELL'OLIO COMPLETA	POMPE À HUILE COMPLÈTE	1
21	PAF25-05050014	93210-14515	TÓRICA B	O-RING B	O-RING B	JOINT TORIQUE B	1
22	PAF25-05050013	93210-12MG9	TÓRICA A	O-RING A	O-RING A	JOINT TORIQUE A	1
23	PAF25-05050015	93210-33MH2	TÓRICA C	O-RING C	O-RING C	JOINT TORIQUE C	1
24	PAF25-05050200	65W-12171-10	ÁRBOL DE LEVAS	CAMSHAFT ASSY	ALBERO A CAMME	ARBRE À CAMES	1
25	PAF25-05050016	93605-14143	PIN CENTRADOR	HOLLOW PIN	SPINOTTO DI CENTRAGGIO	PIN DE CENTRAGE	1
26	PAF25-05050021	93102-37M40	RETÉN	OIL SEAL	PARAOLIO	JOINT SPI	1
27	PAF25-05050017	65W-11537-01	POLEA DE CORREA	BELT PULLEY, DRIVEN	PULEGGIA CINGHIA	POULIE DE COURROIE	1
28	PAF25-05050018	90201-10M06	ARANDELA	WASHER, PLATE	RONDELLA	RONDELLE	1
29	PAGB/T97.1-8	97595-06520	ARANDELA	WASHER, PLATE	RONDELLA	RONDELLE	1
30	REC65W-46241-00	65W-46241-00	CORREA DISTRIBUCIÓN	BELT, TIMING	CINGHIA DISTRIBUZIONE	COURROIE DISTRIBUTION	1
31	PAF25-05000022	65W-11476-00	MUELLE	BUSH, SPRING	MOLLA	RESSORT	1
32	PAF25-05000021	65W-11536-10	ENGRANAJE DE DISTRIBUCIÓN	BELT PULLEY, TIMING	PULEGGIA DE DISTRIBUZIONE	POULIE DE DISTRIBUTION	1
33	PAF25-05050300	65W-12151-00	BALANCÍN COMPLETO	ROCKET ASSY	BILANCERE COMPLETO	CULBUTEUR COMPLÈTE	4
34	PAF25-05050002	62Y-12121-00	VÁLVULA ESCAPE	VALVE, EXHAUST	VALVOLA SCARICO	SOUPAPE D'ÉCHAPPEMENT	2
35	PAF25-05050001	67C-12111-00	VÁLVULA ADMISIÓN	VALVE, INTAKE	VALVOLA ASPIRAZIONE	SOUPAPE D'ADMISSION	2
36	PAF25-05050003	62Y-12116-00	ARANDELA ASIENTO	SEAT, VALVE SPRING	RONDELLA BASAMENTO	SIEGE RESSORT DE SOUPAPE	4
37	PAF166-010003	51Y-12119-00	RETÉN DE ACEITE	OIL SEAL	PARAOLIO	JOINT D'HUILE	4
38	PAF25-05050005	51Y-12114-00	MUELLE DE VÁLVULA	SPRING, VALVE STEM	MOLLA DI VALVOLA	RESSORT DE SOUPAPE	4
39	PAF15-07040006	30X-12117-00	RETÉN RESORTE	SPRING, VALVE RETAINER	VALVOLA DI RITEGNO	JOINT DE RESSORT	4
40	PAF15-07040007	30X-12118-00	SEGURO DE VÁLVULA	CLAMP, VALVE	BLOCCAGGIO DI VALVOLA	CLAVETTE DE SOUPAPE	8
41	PAF15-07040303	62Y-12159-00	TORNILLO REGULADOR	SCREW, VALVE ADJUSTING	VITE REGOLATORE	VIS POINTEAU	4
42	PAF15-07040304	62Y-12158-00	TUERCA	NUT	GHIERA	ÉCROU	4
43	PAF25-05050301	65W-12151-00	BALANCÍN	VALVE ROCKER	BILANCERE	CULBUTEUR	4
44	PAF25-05050008	65W-12146-00	EJE DE BALANCÍN	SHAFT, ROCKER	ASSE BILANCERE	AXE DE CULBUTEUR	1
45	PAF25-05050009	62Y-12238-00	PLETINA	PLATE, BOLT STOPPER	PIASTRINA	PLAQUE	2
46	PAF25-05050011	62Y-12216-00	RESORTE	SPRING	MOLLA	RESSORT	1
47	PAF25-05050012	62Y-12231-00	PLETINA	PLATE B, BOLT STOPPER	PIASTRINA	PLAQUE	1
48	PAF25-05050019	90109-08M63	TORNILLO	BOLT	VITE	VIS	3

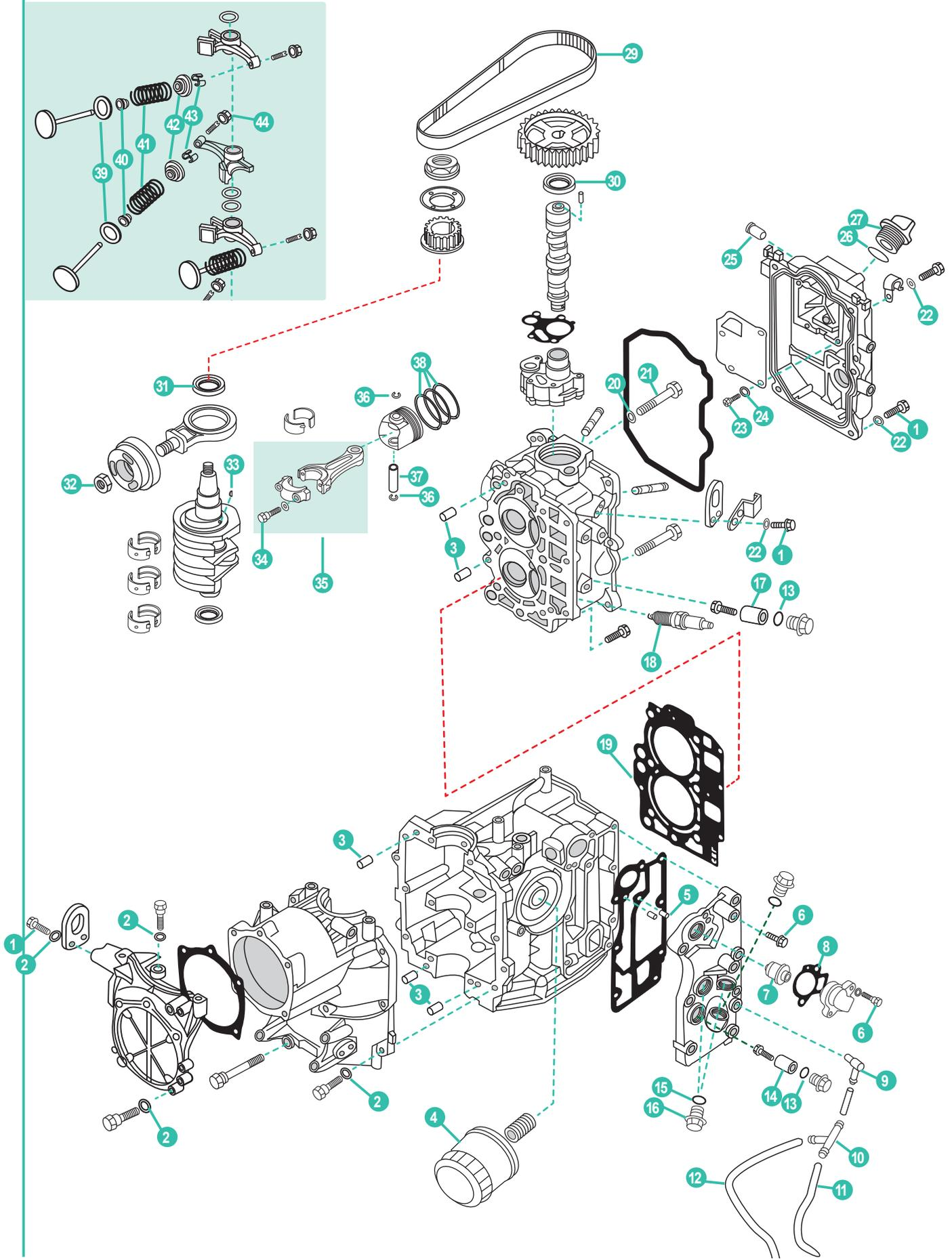

	REF	OEM				UN.	
1	PAGB/T5783-M6X20	97095-06020	TORNILLO	SCREW	VITE	VIS	9
2	PAGB/T97.1-6	92995-06600	ARANDELA	WASHER	RONDELLA	RONDELLE	16
3	REC93606-12019	93606-12019	PIN CENTRADOR	HOLLOW PIN	SPINOTTO DI CENTRAGGIO	PIN DE CENTRAGE	5
4	REC5GH-13440-60	5GH-13440-20	FILTRO ACEITE	OIL FILTER	FILTRO DELL'OLIO	FILTRE À HUILE	1
5	PAF25-04000007	93604-10M03	PIN CENTRADOR	HOLLOW PIN	SPINOTTO DI CENTRAGGIO	PIN DE CENTRAGE	2
6	PAGB/T5783-M6X30	90119-06MA5	TORNILLO	SCREW	VITE	VIS	8
7	PAF15-07000031	6G8-12411-03	TERMOSTATO	THERMOSTAT	TERMOSTATO	THERMOSTAT	1
8	PAF15-07010022	62Y-12414-00	JUNTA TAPA TERMOSTATO	GASKET, THERMOSTAT COVER	GUARNIZIONE COPERCHIO TERMOSTATO	JOINT COUVERCLE DE THERMOSTAT	1
9	PAF15-04000005	676-11372-00	NIPLE DE MANGUERA	NIPPLE	TUBO	RACCORD D'EAU	1
10	PAF15-05000011	688-24378-00	CONECTOR DE 3 VÍAS	THREE-WAY PIPE	CONNETTORE T	TE	1
11	PAF25-03000011	90445-09251	TUBO DE AGUA	WATER TUBE	TUBO DELL'ACQUA	DURITE D'EAU	1
12	PAF25-03000009	90445-09104	TUBO DE AGUA	WATER TUBE	TUBO DELL'ACQUA	DURITE D'EAU	1
13	PAGB/T3452.1-13X2	93210-13M63	TÓRICA	O-RING	O-RING	JOINT TORIQUE	1
14	CM6G8-11325-00A	6G8-11325-00	ÁNODO	ANODE	ANODO	ANODE	1
15	PAF15-04000003	90430-14115	TÓRICA	O-RING	O-RING	JOINT TORIQUE	2
16	PAF15-04000002	90340-14M06	TORNILLO DRENAJE	BOLT, DISCHARGING OIL	VITE DRENAGGIO	BOUCHON DE VIDANGE	2
17	CM6BL-11325-00A	6BL-11325-00	ÁNODO	ANODE	ANODO	ANODE	2
18	NGKDP6EB-9	94702-00418	BUJÍA	SPARK PLUG	CANDELE	BOUGIE	2
19	REC6BL-11181-00	6BL-11181-00	JUNTA CULATA	GASKET, CYLINDER HEAD	GUARNIZIONE TESTATA	JOINT DE CULASSE	1
20	PAF25-05050007	90430-06014	JUNTA	GASKET	GUARNIZIONE	JOINT	1
21	PAF25-05050006	90109-06M65	PERNO	STUD	BULLONE	BOULON	1
22	PAGB/T96-6	92995-06600	ARANDELA	WASHER	RONDELLA	RONDELLE	8
23	PAGB/T818-M4X10	98507-04010	TORNILLO	SCREW	VITE	VIS	4
24	PAGB/T97.1-4	92907-04600	ARANDELA	WASHER	RONDELLA	RONDELLE	4
25	PAF20-05040005	62Y-14485-00	PIPA DE AGUA	PIPE, WATER	TUBO	RACCORD TUYAU D'EAU	1
26	PAJASOF40431-025	93210-24M79	TÓRICA	O-RING	O-RING	JOINT TORIQUE	1
27	PAF15-07050004	6G8-15363-00	TAPÓN ACEITE	PLUG, OIL	TAPPO OLIO	BOUCHON REMPLISSAGE D'HUILE	1
28	PAF15-07010015	90465-08M83	BRIDA	CLAMP	FLANGIA	COLLIER	1
29	REC6C5-46241-00	6C5-46241-00	CORREA DISTRIBUCIÓN	BELT, TIMING	CINGHIA DISTRIBUZIONE	COURROIE DISTRIBUTION	1
30	PAF25-05050021	93102-37M40	RETÉN DE ACEITE	OIL SEAL	PARAOLIO	JOINT SPI	1
31	PAF25-05020003	93102-43M42	RETÉN DE ACEITE	OIL SEAL	PARAOLIO	JOINT SPI	1
32	PAF25-05000026	90170-20137	TUERCA	LOCK NUT	DADO	ÉCROU	1
33	PAGB/T1099-3X5X13	90280-03M01	CUÑA	KEY WOODRUFF	CHIAVETTA	CLAVETTE	1
34	PAF25-05020204	6C5-11654-00	TORNILLO	SCREW	VITE	VIS	2
35	PAF25-05020200	6C5-11650-00	BIELA COMPELTA	ROD, CONNECTING ASSY	BIELLA COMPLETA	BIELLE COMPLÈTE	2
36	PAF25-05020106	93450-17129	CIRCLIP	CIRCLIP	CIRCLIP	CIRCLIP	4
37	PAF25-05020105	62Y-11633-00	PIN, PISTÓN	PIN, PISTON	SPINOTTO PISTONE	AXE DE PISTON	2
38	REC67C-11603-00	67C-11603-00	KIT SEGMENTOS DE PISTÓN	PISTON RING KIT	KIT FASCIA PISTONE	KIT SEGMENTS	2
39	PAF25-05050003	62Y-12116-00	ARANDELA ASIENTO	SEAT, VALVE SPRING	RONDELLA BASAMENTO	SIEGE RESSORT DE SOUPAPE	4
40	PA166F-010003	51Y-12119-00	RETÉN DE ACEITE	OIL SEAL	PARAOLIO	JOINT D'HUILE	4
41	PAF25-05050005	51Y-12114-00	MUELLE DE VÁLVULA	SPRING, VALVE STEM	MOLLA DI VALVOLA	RESSORT DE SOUPAPE	4
42	PAF15-07040006	30X-12117-00	RETÉN RESORTE	SPRING, VALVE RETAINER	VALVOLA DI RITEGNO	JOINT DE RESSORT	4
43	PAF15-07040007	30X-12118-00	SEGURO DE VÁLVULA	CLAMP, VALVE	BLOCCAGGIO DI VALVOLA	CLAVETTE DE SOUPAPE	8
44	PAF15-07040304	62Y-12158-00	TUERCA	NUT	GHIERA	ÉCROU	1



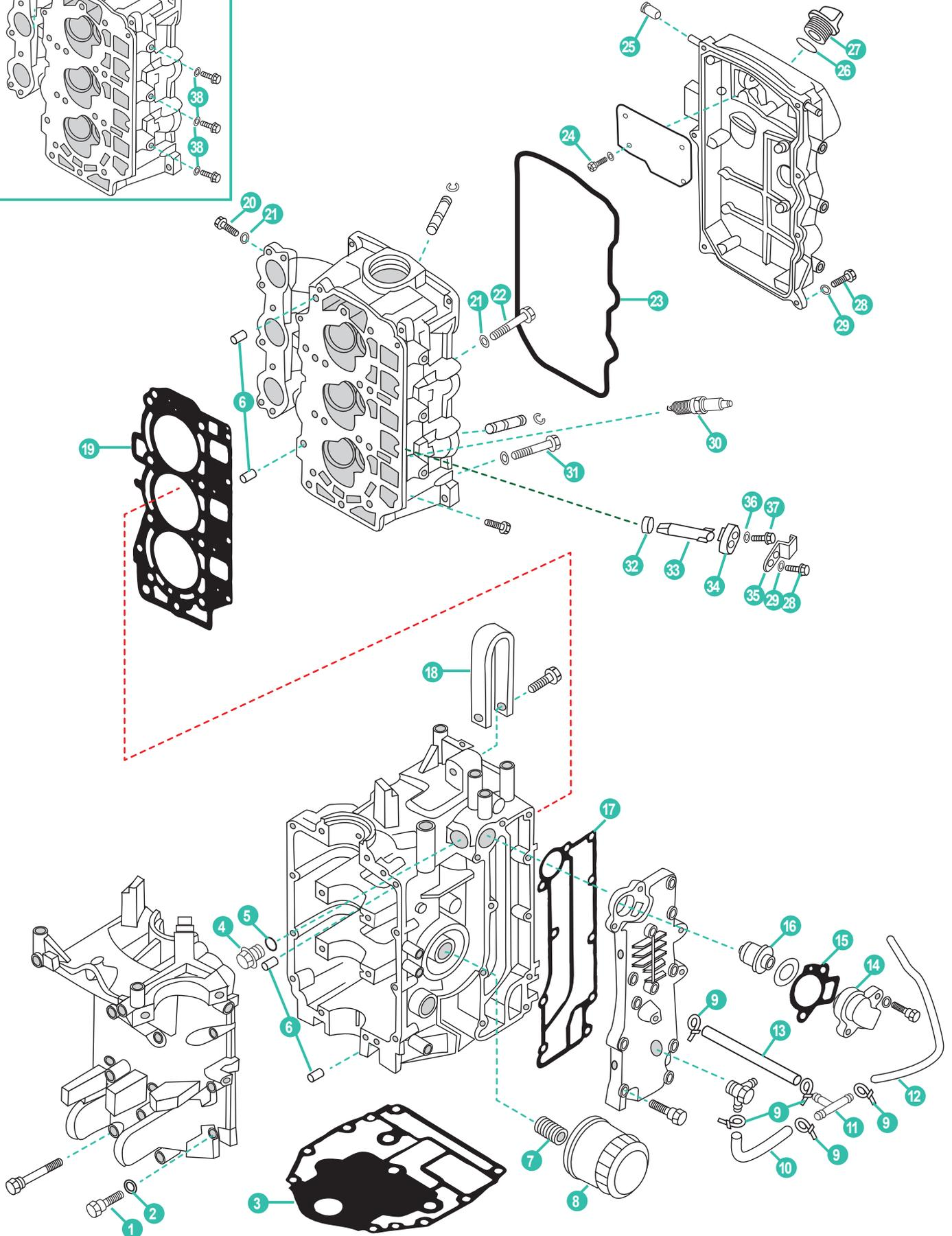
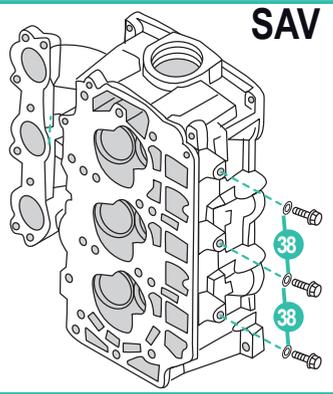

	REF	OEM					UN.
1	PAF15-07000030	97013-06035	TORNILLO	STUD	BULLONE	BOULON	8
2	PAGB/T97.1-6	92903-06600	ARANDELA	WASHER	RONDELLA	RONDELLE	8
3	REC67C-11351-00	67C-11351-01	JUNTA BASE MOTOR	GASKET ENGINE	GUARNIZIONE BASE MOTORE	JOINT MOTEUR	1
4	PAF15-04000002	90340-14M06	TORNILLO DRENAJE	BOLT, DISCHARGING OIL	VITE DRENAGGIO	BOUCHON DE VIDANGE	1
5	PAF15-04000003	90430-14115	TÓRICA	O-RING	O-RING	JOINT TORIQUE	1
6	PAF25-00000014	99530-08012	PIN CENTRADOR	HOLLOW PIN	SPINOTTO DI CENTRAGGIO	PIN DE CENTRAGE	4
7	PAF15-07010003	90401-20M00	PERNO	STUD	BULLONE	BOULON	1
8	REC5GH-13440-00	5GH-13440-00	FILTRO ACEITE	OIL FILTER	FILTRO DELL'OLIO	FILTRE À HUILE	1
9	PAHT-2.5X60	90465-11M10	BRIDA	CLAMP	FLANGIA	COLLIER	5
10	PAF25-03000008	90445-09068	TUBO DE AGUA	WATER TUBE	TUBO DELL'ACQUA	DURITE D'EAU	1
11	PAF15-05000011	688-24378-00	CONECTOR DE 3 VÍAS	THREE-WAY PIPE	CONNETTORE T	TE	1
12	PAF15-05000014	90445-09104	TUBO DE AGUA	WATER TUBE	TUBO DELL'ACQUA	DURITE D'EAU	1
13	PAF25-03000009	90445-09095	TUBO DE AGUA	WATER TUBE	TUBO DELL'ACQUA	DURITE D'EAU	1
14	PAF15-07010021	6H3-12413-00-1S	TAPA TERMOSTATO	COVER, THERMOSTAT	COPERCHIO TERMOSTATO	COUVERCLE DE THERMOSTAT	1
15	PAF15-07010022	62Y-12414-00	JUNTA TAPA TERMOSTATO	GASKET, THERMOSTAT COVER	GUARNIZIONE COPERCHIO TERMOSTATO	JOINT COUVERCLE DE THERMOSTAT	1
16	PAF15-07000031	6G8-12411-03	TERMOSTATO	THERMOSTAT	TERMOSTATO	THERMOSTAT	1
17	REC67C-41114-00	67C-41114-10	JUNTA EXTERIOR, TAPA DE ESCAPE	GASKET, EXHAUST OUTER COVER	GUARNIZIONE ESTERIORE, COPERCHIO SCARICO	JOINT COUVERCLE EXT ECHAPPEMENT	1
18	PAF25-05010106	65W-11119-00	SOPORTE	HANGER, ENGINE	SUPPORTO	CROCHET LEVAGE MOTEUR	1
19	REC67C-11181-01	67C-11181-01	JUNTA CULATA	GASKET, CYLINDER HEAD	GUARNIZIONE TESTATA	JOINT DE CULASSE	1
20	PAGB/T5783-M6X10	97095-06010	TORNILLO	SCREW	VITE	VIS	3
21	PAF25-05050007	90430-06014	JUNTA	GASKET	GUARNIZIONE	JOINT	3
22	PAF25-05050006	90109-06M65	PERNO	STUD	BULLONE	BOULON	1
23	REC67C-11356-00	67C-11356-00	JUNTA TAPA	GASKET, COVER	GUARNIZIONE COPERCHIO	JOINT COUVERCLE	1
24	PAGB/T818-M4X10	98507-04010	TORNILLO	SCREW	VITE	VIS	4
25	PAF40-05070002	62Y-14485-00	PIPA DE AGUA	PIPE, WATER	TUBO	RACCORD TUYAU D'EAU	1
26	PAJASOF40431-025	93210-24M79	TÓRICA	O-RING	O-RING	JOINT TORIQUE	1
27	PAF15-07050004	6G8-15363-00	TAPÓN ACEITE	PLUG, OIL	TAPPO OLIO	BOUCHON REMPLISSAGE D'HUILE	1
28	PAGB/T5783-M6X20	97095-06020	TORNILLO	SCREW	VITE	VIS	7
29	PAGB/T97.1-6	92995-06600	ARANDELA	WASHER	RONDELLA	RONDELLE	7
30	NGKDPR6EA-9	94701-00375	BUJÍA	SPARK PLUG	CANDELA	BOUGIE	3
31	PAF25-05000002	90119-09M00	TORNILLO	SCREW	VITE	VIS	8
32	PAF15-07010009	66M-11328-00	TAPÓN	PLUG	TAPPO	BOUCHON	3
33	CM62Y-11325-00A	62Y-11325-00	ÁNODO	ANODE	ANODO	ANODE	3
34	PAF15-07010011	66M-11327-00-94	TAPA ÁNODO	COVER, ANODE	COPERTURA ANODO	COUVERCLE D'ANODE	3
35	PAF15-07010012	66M-12535-00	PLETINA DEL ÁNODO	PLATE, ANODE	PIASTRA ANODO	PLAQUE D'ANODE	3
36	PAGB/T97.1-5	92995-05600	ARANDELA	WASHER	RONDELLA	RONDELLE	3
37	PAGB/T818-M5X12	97095-05012	TORNILLO	SCREW	VITE	VIS	3
38	PAF4-04000006	90430-08143	JUNTA	GASKET	GUARNIZIONE	JOINT	3

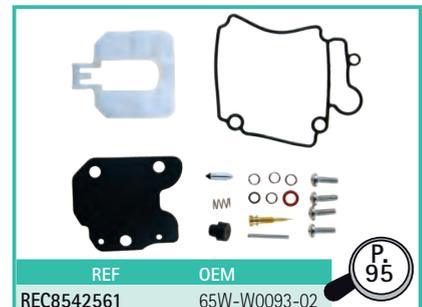
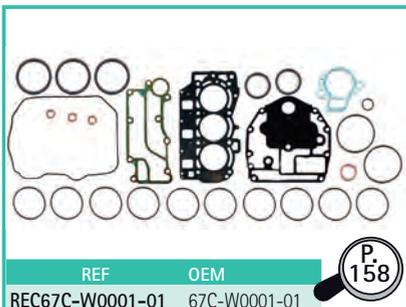

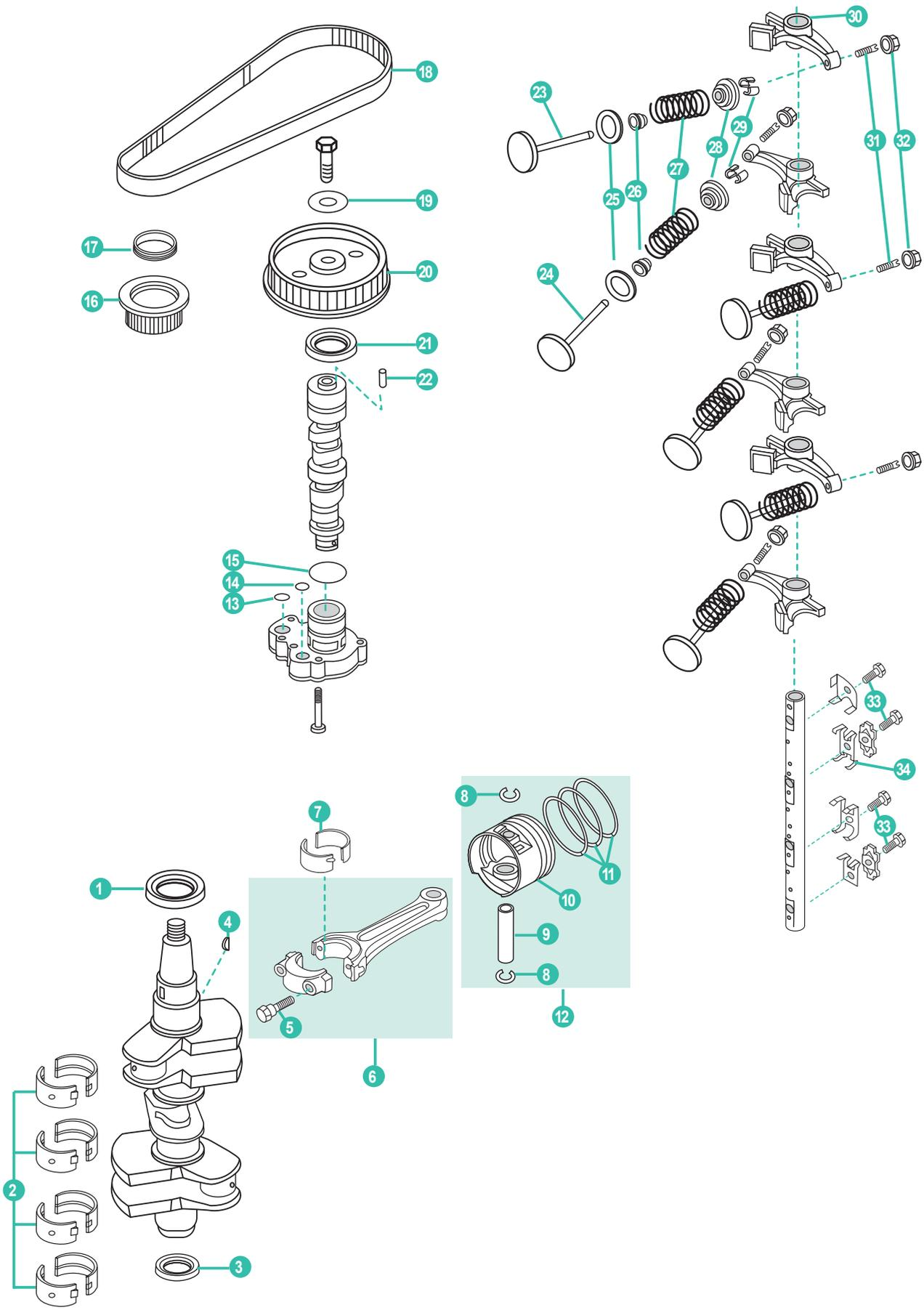



	REF	OEM				UN.	
1	PAF25-05020003	93102-43M42	RETÉN DE ACEITE	OIL SEAL	PARAOLIO	JOINT SPI	1
2	PAF25-05010302-1	62Y-11416-00	COJINETE BANCADA <b>BROWN</b>	MAIN BEARING <b>BROWN</b>	CUSCINETTO <b>BROWN</b>	PALIER DE VILEBREQUIN <b>BROWN</b>	8
	PAF25-05010302-2	62Y-11416-10	COJINETE BANCADA <b>BLACK</b>	MAIN BEARING <b>BLACK</b>	CUSCINETTO <b>BLACK</b>	PALIER DE VILEBREQUIN <b>BLACK</b>	8
3	PAF25-05020002	93102-35M47	RETÉN DE ACEITE	OIL SEAL	PARAOLIO	JOINT SPI	1
4	PAF25-05000024	90280-04M06	CUÑA	KEY WOODRUFF	CHIAVETTA	CLAVETTE	1
5	PAF25-05020204	62Y-11654-00	TORNILLO	SCREW	VITE	VIS	2
6	PAF25-05020200	62Y-11650-10	BIELA COMPLETA	ROD, CONNECTING ASSY	BIELLA COMPLETA	BIELLE COMPLÈTE	3
7	PAF25-05020203-1	62Y-11656-00	COJINETE DE BIELA <b>BROWN</b>	BEARING, CONNECTING ROD <b>BROWN</b>	CUSCINETTO BIELLA <b>BROWN</b>	PALIER DE BIELLE <b>BROWN</b>	6
	PAF25-05020203-2	62Y-11656-10	COJINETE DE BIELA <b>BLACK</b>	BEARING, CONNECTING ROD <b>BLACK</b>	CUSCINETTO BIELLA <b>BLACK</b>	PALIER DE BIELLE <b>BLACK</b>	6
8	PAF25-05020106	93450-17129	CIRCLIP	CIRCLIP	CIRCLIP	CIRCLIP	6
9	PAF25-05020105	62Y-11633-00	PIN, PISTÓN	PIN, PISTON	SPINOTTO PISTONE	AXE DE PISTON	3
10	PAF25-05020101	65W-11631-00-96	PISTÓN	PISTON	PISTONE	PISTON	3
11	REC67C-11603-00	67C-11603-00	KIT SEGMENTOS DE PISTÓN	PISTON RING KIT	KIT FASCIA PISTONE	KIT SEGMENTS	3
12	PAF25-05020100	65W-11631-00-96	KIT PISTÓN	PISTON KIT	KIT PISTONE	KIT PISTON	3
13	PAF25-05050014	93210-14515	TÓRICA	O-RING	O-RING	JOINT TORIQUE	1
14	PAF25-05050013	93210-12MG9	TÓRICA	O-RING	O-RING	JOINT TORIQUE	1
15	PAF25-05050015	93210-33MH2	TÓRICA	O-RING	O-RING	JOINT TORIQUE	1
16	PAF25-05000021	65W-11536-10	ENGRANAJE DE DISTRIBUCIÓN	BELT PULLEY, TIMING	PULEGGIA DE DISTRIBUZIONE	POULIE DE DISTRIBUTION	1
17	PAF25-05000022	65W-11476-00	RESORTE	SPRING	MOLLA	RESSORT	1
18	REC65W-46241-00	65W-46241-00	CORREA DISTRIBUCIÓN	BELT, TIMING	CINGHIA DISTRIBUZIONE	COURROIE DISTRIBUTION	1
19	PAF25-05050018	90201-10M06	ARANDELA	WASHER	RONDELLA	RONDELLE	1
20	PAF40-05040006	67C-11537-01	POLEA DE CORREA	BELT PULLEY, DRIVEN	PULEGGIA CINGHIA	POULIE DE COURROIE	1
21	PAF25-05050021	93102-37M40	RETÉN DE ACEITE	OIL SEAL	PARAOLIO	JOINT SPI	1
22	PAF25-05050016	93605-14143	PIN CENTRADOR	HOLLOW PIN	SPINOTTO DI CENTRAGGIO	PIN DE CENTRAGE	1
23	PAF25-05050002	62Y-12121-00	VÁLVULA ESCAPE	VALVE, EXHAUST	VALVOLA SCARICO	SOUPAPE D'ÉCHAPPEMENT	3
24	PAF25-05050001	67C-12111-00	VÁLVULA ADMISIÓN	VALVE, INTAKE	VALVOLA ASPIRAZIONE	SOUPAPE D'ADMISSION	3
25	PAF25-05050003	62Y-12116-00	ARANDELA ASIENTO	SEAT, VALVE SPRING	RONDELLA BASAMENTO	SIEGE RESSORT DE SOUPAPE	6
26	PAPS2700.04.03	51Y-12119-00	RETÉN DE ACEITE	OIL SEAL	PARAOLIO	JOINT SPI	6
27	PAF25-05050005	51Y-12114-00	MUELLE DE VÁLVULA	SPRING, VALVE STEM	MOLLA DI VALVOLA	RESSORT DE SOUPAPE	6
28	PAF15-07040006	30X-12117-00	RETÉN RESORTE	SPRING, VALVE RETAINER	VALVOLA DI RITEGNO	JOINT DE RESSORT	6
29	PAF15-07040007	30X-12118-00	SEGURO DE VÁLVULA	CLAMP, VALVE	BLOCCAGGIO DI VALVOLA	CLAVETTE DE SOUPAPE	12
30	PAF25-05050301	65W-12151-00	BRAZO DE BALANCÍN	ARM, VALVE ROCKER	BILANCERE	CULBUTEUR	6
31	PAF15-07040303	62Y-12159-00	TORNILLO REGULADOR	SCREW, VALVE ADJUSTING	VITE REGOLATORE	VIS POINTEAU	6
32	PAF15-07040304	62Y-12158-00	TUERCA	LOCK NUT	DADO	ÉCROU	6
33	PAF25-05050019	90109-08M63	TORNILLO	SCREW	VITE	VIS	4
34	PAF25-05050011	62Y-12216-00	RESORTE	SPRING	MOLLA	RESSORT	1

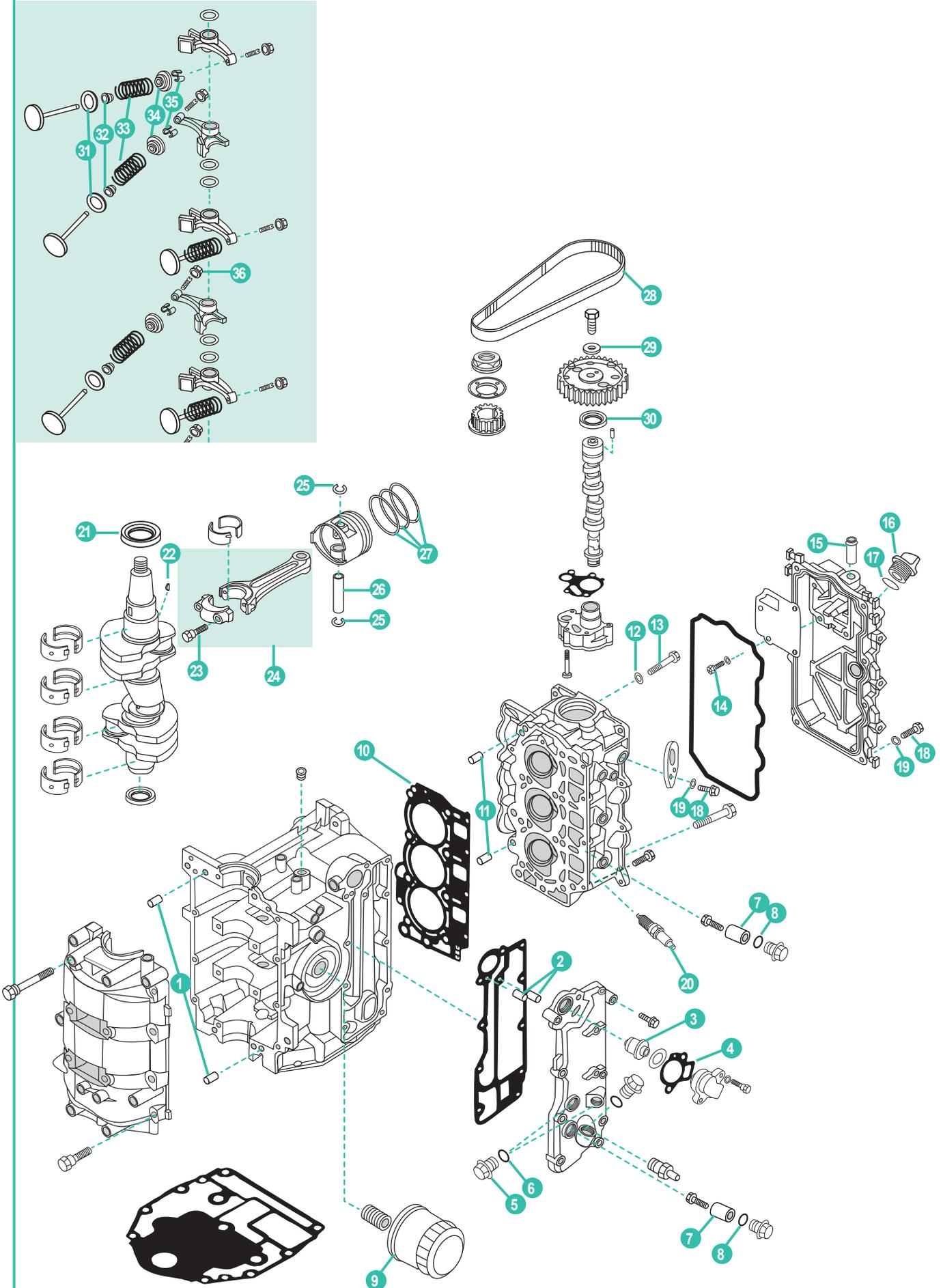

	REF	OEM				UN.	
1	REC93606-12019	93606-12019	PIN CENTRADOR	HOLLOW PIN	SPINOTTO DI CENTRAGGIO	PIN DE CENTRAGE	4
2	PAF15-00000013	93604-10M03	PIN CENTRADOR	HOLLOW PIN	SPINOTTO DI CENTRAGGIO	PIN DE CENTRAGE	2
3	PAF15-07000031	6G8-12411-03	TERMOSTATO	THERMOSTAT	TERMOSTATO	THERMOSTAT	1
4	PAF15-07010022	62Y-12414-00	JUNTA TAPA TERMOSTATO	GASKET, THERMOSTAT COVER	GUARNIZIONE COPERCHIO TERMOSTATO	JOINT COUVERCLE DE THERMOSTAT	1
5	PAF15-04000002	90340-14M06	TORNILLO DRENAJE	BOLT, DISCHARGING OIL	VITE DRENAGGIO	VIS DE VIDANGE	2
6	PAF15-04000003	90430-14115	TÓRICA	O-RING	O-RING	JOINT TORIQUE	2
7	CM6G8-11325-00A	6G8-11325-00	ÁNODO	ANODE	ANODO	ANODE	2
8	PAGB/T3452.1-13X2	93210-13M63	TÓRICA	O-RING	O-RING	JOINT TORIQUE	5
9	REC5GH-13440-60	5GH-13440-50	FILTRO ACEITE	OIL FILTER	FILTRO DELL'OLIO	FILTRE À HUILE	1
10	REC6BG-11181-00	6BG-11181-00	JUNTA CULATA	GASKET, CYLINDER HEAD	GUARNIZIONE TESTATA	JOINT DE CULASSE	1
11	PAF25-00000014	99530-08012	PIN CENTRADOR	HOLLOW PIN	SPINOTTO DI CENTRAGGIO	PIN DE CENTRAGE	2
12	PAF25-05050007	90430-06014	JUNTA	GASKET	GUARNIZIONE	JOINT	1
13	PAF25-05050006	90109-06M65	PERNO	STUD	BULLONE	BOULON	1
14	PAGB/T818-M4X10	98507-04010	TORNILLO	SCREW	VITE	VIS	4
15	PAF40-05070002	62Y-14485-00	PIPA DE AGUA	PIPE, WATER	TUBO	RACCORD TUYAU D'EAU	1
16	PAF15-07050004	6G8-15363-00	TAPÓN ACEITE	PLUG, OIL	TAPPO OLIO	BOUCHON DE REMPLISSAGE D'HUILE	1
17	PAF4-04000008	93210-24M79	TÓRICA	O-RING	O-RING	JOINT TORIQUE	1
18	PAGB/T5783-M6X20	97095-06020	PERNO	STUD	BULLONE	BOULON	9
19	PAGB/T97.1-6	92995-06600	ARANDELA	WASHER	RONDELLA	RONDELLE	9
20	NGKDPR6EB-9	94702-00418	BUJÍA	SPARK PLUG	CANDELA	BOUGIE	3
21	PAF25-05020003	93102-43M42	RETÉN DE ACEITE	OIL SEAL	PARAOLIO	JOINT D'HUILE	1
22	PAGB/T1099-3X5X13	90280-03017	CUÑA	KEY WOODRUFF	CHIAVETTA	CLAVETTE	1
23	PAF25-05020204	6C5-11654-00	TORNILLO	SCREW	VITE	VIS	2
24	PAF25-05020200	6C5-11650-10	BIELA COMPLETA	ROD, CONNECTING ASSY	BIELLA COMPLETA	BIELLE COMPLÈTE	3
25	PAF25-05020106	93450-17129	CIRCLIP	CIRCLIP	CIRCLIP	CIRCLIP	6
26	PAF25-05020105	62Y-11633-00	PIN, PISTÓN	PIN, PISTON	SPINOTTO PISTONE	AXE DE PISTON	3
27	REC67C-11603-00	67C-11603-00	KIT SEGMENTOS DE PISTÓN	PISTON RING KIT	KIT FASCIA PISTONE	KIT DE SEGMENTS	3
28	REC6C5-46241-00	6C5-46241-00	CORREA	BELT	CINGHIA	COURROIE DISTRIBUTION	1
29	PAF25-05050018	90201-10144	ARANDELA	WASHER	RONDELLA	RONDELLE	1
30	PAF25-05050021	93102-37M40	RETÉN DE ACEITE	OIL SEAL	PARAOLIO	JOINT D'HUILE	1
31	PAF25-05050003	62Y-12116-00	ARANDELA ASIENTO	SEAT, VALVE SPRING	RONDELLA BASAMENTO	SIEGE RESSORT DE SOUPAPE	6
32	PA166F-010003	51Y-12119-00	RETÉN DE ACEITE	OIL SEAL	PARAOLIO	JOINT D'HUILE	6
33	PAF25-05050005	51Y-12114-00	MUELLE DE VÁLVULA	SPRING, VALVE STEM	MOLLA DI VALVOLA	RESSORT DE SOUPAPE	6
34	PAF15-07040006	30X-12117-00	RETÉN RESORTE	SPRING, VALVE RETAINER	VALVOLA DI RITEGNO	JOINT DE RESSORT	6
35	PAF15-07040007	30X-12118-00	SEGURO DE VÁLVULA	CLAMP, VALVE	BLOCCAGGIO DI VALVOLA	CLAVETTE DE SOUPAPE	12
36	PAF15-07040304	62Y-12158-00	TUERCA	LOCK NUT	DADO	ÉCROU	1



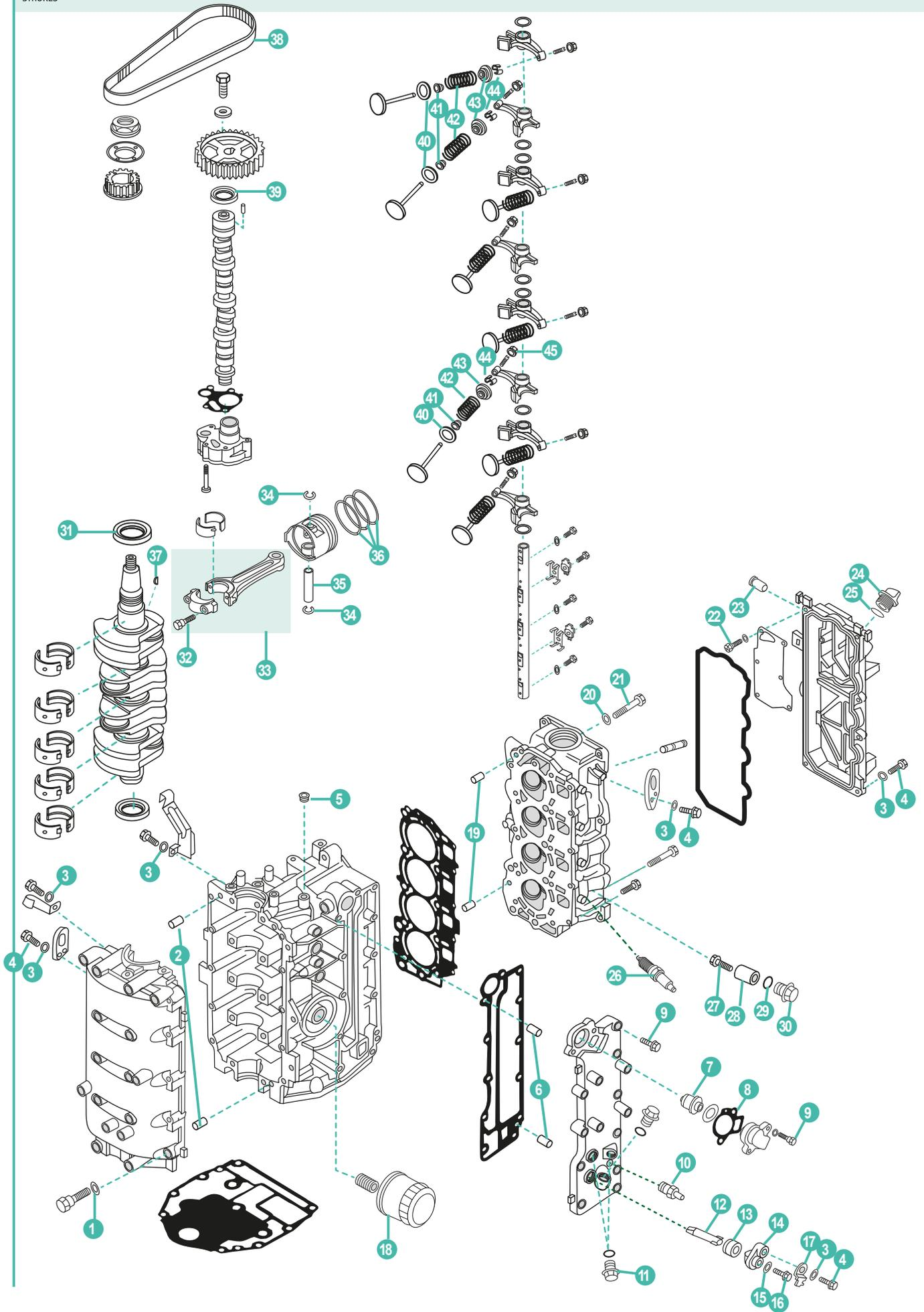

	REF	OEM				UN.	
1	PAGB/T848-6	92903-06600	ARANDELA	WASHER	RONDELLA	RONDELLE	10
2	REC93606-12019	93606-12019	PIN CENTRADOR	HOLLOW PIN	SPINOTTO DI CENTRAGGIO	PIN DE CENTRAGE	4
3	PAGB/T97.1-6	92995-06600	ARANDELA	WASHER	RONDELLA	RONDELLE	14
4	PAGB/T5783-M6X20	97095-06020	PERNO	STUD	BULLONE	BOULON	12
5	PAF15-07010004	90344-51003	TAPÓN	CAP	TAPPO	BOUCHON	1
6	PAF25-04000007	93604-10M03	PIN CENTRADOR	HOLLOW PIN	SPINOTTO DI CENTRAGGIO	PIN DE CENTRAGE	2
7	PAF15-07000031	6G8-12411-03	TERMOSTATO	THERMOSTAT	TERMOSTATO	THERMOSTAT	1
8	REC6H3-12414-A1	62Y-12414-00	JUNTA TAPA TERMOSTATO	GASKET, THERMOSTAT COVER	GUARNIZIONE COPERCHIO TERMOSTATO	JOINT COUVERCLE DE THERMOSTAT	1
9	PAGB/T5782-M6X35	90119-06MA5	TORNILLO	SCREW	VITE	VIS	12
10	PAF25-05010113	62Y-12481-10	NIPLE DE MANGUERA	NIPPLE	TUBO	RACCORD D'EAU	1
11	PAF15-04000002	90340-14M06	TORNILLO DRENAJE	BOLT, DISCHARGING OIL	VITE DRENAGGIO	VIS DE VIDANGE	2
12	CM62Y-11325-00A	62Y-11325-00	ÁNODO	ANODE	ANODO	ANODE	1
13	PAF15-07010009	66M-11328-00	TAPÓN	CAP	TAPPO	BOUCHON	1
14	PAF15-07010011	66M-11327-00-94	TAPA ÁNODO	COVER, ANODE	COPERTURA ANODO	COUVERCLE DU ANODE	1
15	PAGB/T97.1-8	92995-05600	ARANDELA	WASHER	RONDELLA	RONDELLE	1
16	PAGB/T818-M5X12	97095-05012	PERNO	STUD	BULLONE	BOULON	1
17	PAF15-07010012	66M-12535-00	EMPAQUETADURA DE ÁNODO	PLATE, ANODE	PIASTRA ANODO	PLAQUE D'ANODE	14
18	REC5GH-13440-60	5GH-13440-20	FILTRO ACEITE	OIL FILTER	FILTRO DELL'OLIO	FILTRE À HUILE	1
19	PAF25-00000014	99530-08012	PIN CENTRADOR	HOLLOW PIN	SPINOTTO DI CENTRAGGIO	PIN DE CENTRAGE	2
20	PAF25-05050007	90430-06014	JUNTA	GASKET	GUARNIZIONE	JOINT	1
21	PAF25-05050006	90109-06M65	PERNO	STUD	BULLONE	BOULON	1
22	PAGB/T818-M4X10	98507-04010	TORNILLO	SCREW	VITE	VIS	6
23	PAF40-05070002	62Y-14485-00	PIPA DE AGUA	PIPE, WATER	TUBO	RACCORD TUYAU D'EAU	1
24	PAF15-07050004	6G8-15363-00	RETÉN DE ACEITE	OIL SEAL	PARAOLIO	JOINT D'HUILE	1
25	PAF4-04000008	93210-24M79	TÓRICA	O-RING	O-RING	JOINT TORIQUE	1
26	NGK DPR6EB-9	94702-00418	BUJÍA	PLUG SPARK	CANDELA	BOUGIE	4
27	PAGB/T818-M5X25	97880-05025	TORNILLO	SCREW	VITE	VIS	4
28	CM6G8-11325-00A	6G8-11325-00	ÁNODO	ANODE	ANODO	ANODE	4
29	PAGB/T3452.1-13X2	93210-13M63	TÓRICA	O-RING	O-RING	JOINT TORIQUE	4
30	PAF20-05030009	6G8-11197-01	TAPÓN	CAP	TAPPO	BOUCHON	4
31	PAF25-05020003	93102-43M42	RETÉN DE ACEITE	OIL SEAL	PARAOLIO	JOINT SPI	1
32	PAF25-05020204	6C5-11654-00	TORNILLO	SCREW	VITE	VIS	2
33	PAF25-05020200	6C5-11650-00	BIELA COMPLETA	ROD, CONNECTING ASSY	BIELLA COMPLETA	BIELLE COMPLÈTE	4
34	PAF25-05020106	93450-17129	CIRCLIP	CIRCLIP	CIRCLIP	CIRCLIP	8
35	PAF25-05020105	62Y-11633-00	PIN, PISTÓN	PIN, PISTON	SPINOTTO PISTONE	AXE DE PISTON	4
36	REC67C-11603-00	67C-11603-00	KIT SEGMENTOS DE PISTÓN	PISTON RING KIT	KIT FASCIA PISTONE	KIT DE SEGMENTS	4
37	PAGB/T1099-3X5X13	90280-03M01	CHAVETA	KEY WOODRUFF	CHIAVETTA	CLAVETTE	1
38	REC6C5-46241-00	6C5-46241-00	CORREA DISTRIBUCIÓN	BELT, TIMING	CINGHIA DISTRIBUZIONE	COURROIE DISTRIBUTION	1
39	PAF25-05050021	93102-37M40	RETÉN DE ACEITE	OIL SEAL	PARAOLIO	JOINT SPI	1
40	PAF25-05050003	62Y-12116-00	ARANDELA ASIENTO	SEAT, VALVE SPRING	RONDELLA BASAMENTO	SIEGE RESSORT DE SOUPAPE	8
41	PAPS2700.04.03	51Y-12119-00	RETÉN DE ACEITE	OIL SEAL	PARAOLIO	JOINT SPI	8
42	PAF25-05050005	51Y-12114-00	MUELLE DE VÁLVULA	SPRING, VALVE STEM	MOLLA DI VALVOLA	RESSORT DE SOUPAPE	8
43	PAF15-07040006	30X-12117-00	RETÉN RESORTE	SPRING, VALVE RETAINER	VALVOLA DI RITEGNO	JOINT DE RESSORT	8
44	PAF15-07040007	30X-12118-00	SEGURO DE VÁLVULA	CLAMP, VALVE	BLOCCAGGIO DI VALVOLA	CLAVETTE DE SOUPAPE	16
45	PAF15-07040304	62Y-12158-00	TUERCA	LOCK NUT	DADO	ÉCROU	1



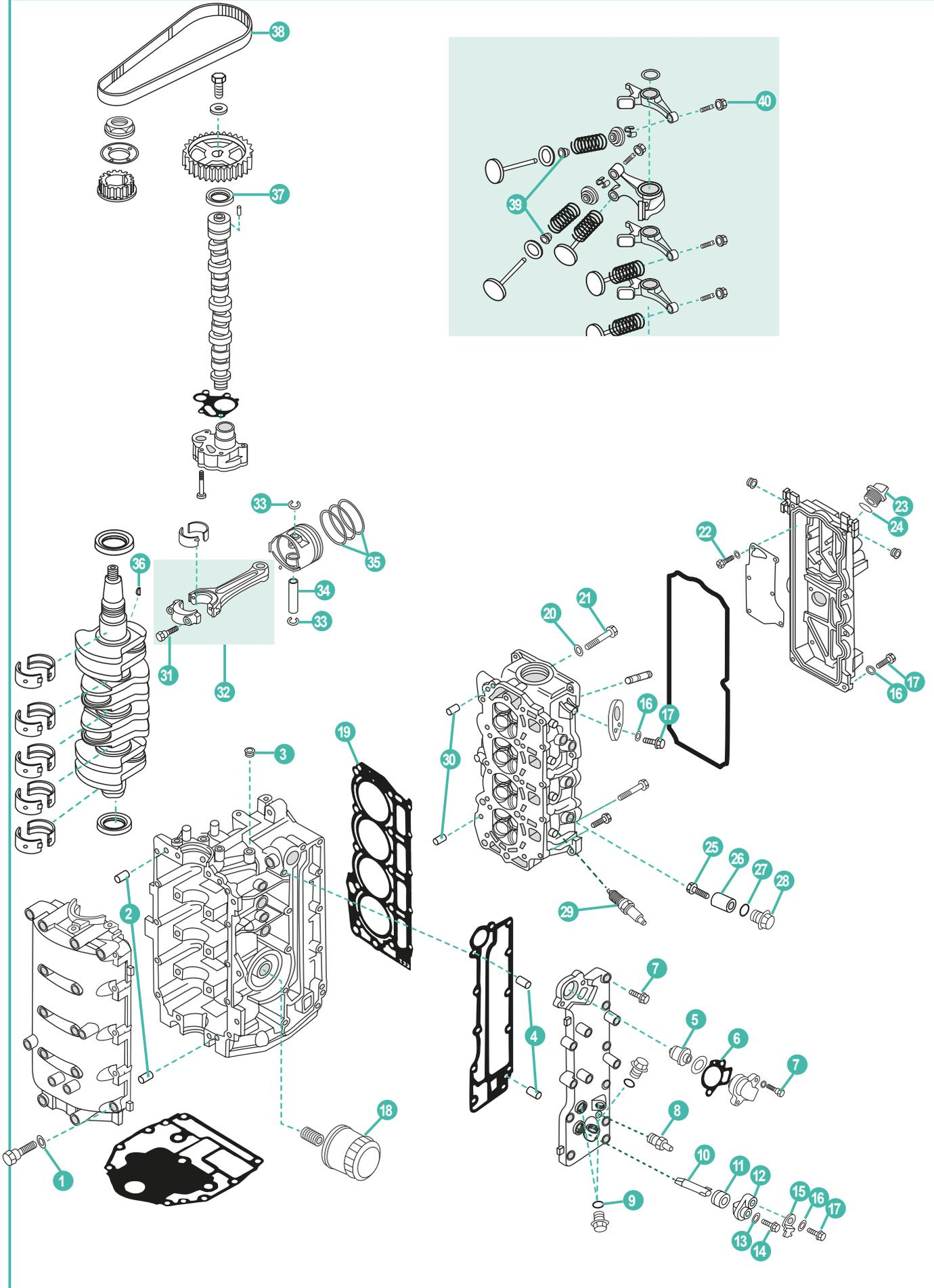

	REF	OEM					UN.
1	PAGB/T848-6	92903-06600	ARANDELA	WASHER	RONDELLA	RONDELLE	10
2	REC93606-12019	90606-12019	PIN CENTRADOR	HOLLOW PIN	SPINOTTO DI CENTRAGGIO	PIN DE CENTRAGE	4
3	PAF15-07010004	90344-51003	TAPÓN	CAP	TAPPO	BOUCHON	1
4	PAF25-04000007	93604-10M03	PIN CENTRADOR	HOLLOW PIN	SPINOTTO DI CENTRAGGIO	PIN DE CENTRAGE	2
5	PAF15-07000031	6G8-12411-03	TERMOSTATO	THERMOSTAT	TERMOSTATO	THERMOSTAT	1
6	REC6H3-12414-A1	62Y-12414-00	JUNTA TAPA TERMOSTATO	GASKET, THERMOSTAT COVER	GUARNIZIONE COPERCHIO TERMOSTATO	JOINT COUVERCLE DE THERMOSTAT	1
7	PAGB/T5782-M6X35	90119-06MA5	ARANDELA	WASHER	RONDELLA	RONDELLE	12
8	PAF25-05010113	62Y-12481-10	NIPLE DE MANGUERA	NIPPLE	TUBO	RACCORD D'EAU	1
9	PAF15-04000002	90340-14M06	TORNILLO DRENAJE	BOLT, DISCHARGING OIL	VITE DRENAGGIO	VIS DE VIDANGE	2
10	CM62Y-11325-00A	62Y-11325-00	ÁNODO	ANODE	ANODO	ANODE	1
11	PAF15-07010009	66M-11328-00	TAPÓN	CAP	TAPPO	BOUCHON	1
12	PAF15-07010011	66M-11327-00-94	TAPA ÁNODO	COVER, ANODE	COPERTURA ANODO	COUVERCLE DU ANODE	1
13	PAGB/T97.1-8	92995-05600	ARANDELA	WASHER	RONDELLA	RONDELLE	1
14	PAGB/T818-M5X12	97095-05012	PERNO	STUD	BULLONE	BOULON	1
15	PAF15-07010012	66M-12535-00	EMPAQUETADURA DE ÁNODO	PLATE, ANODE	PIASTRA ANODO	PLAQUE D'ANODE	1
16	PAGB/T97.1-6	92995-06600	ARANDELA	WASHER	RONDELLA	RONDELLE	1
17	PAGB/T5783-M6X20	97095-06020	PERNO	STUD	BULLONE	BOULON	3
18	REC5GH-13440-60	5GH-13440-50	FILTRO ACEITE	OIL FILTER	FILTRO DELL'OLIO	FILTRE À HUILE	1
19	REC6CJ-11181-00	6CJ-11181-00	JUNTA CULATA	GASKET, CYLINDER HEAD	GUARNIZIONE TESTATA	JOINT DE CULASSE	1
20	PAF25-05050007	90430-06014	JUNTA	GASKET	GUARNIZIONE	JOINT	1
21	PAF25-05050006	90109-06M65	PERNO	STUD	BULLONE	BOULON	1
22	PAGB/T818-M4X10	98507-04010	TORNILLO	SCREW	VITE	VIS	6
23	PAF15-07050004	6G8-15363-00	TAPÓN ACEITE	PLUG, OIL	TAPPO OLIO	BOUCHON REMPLISSAGE D'HUILE	1
24	PAF4-04000008	93210-24M79	TÓRICA	O-RING	O-RING	JOINT TORIQUE	1
25	PAGB/T818-M5X25	97880-05025	TORNILLO	SCREW	VITE	VIS	3
26	CM6G8-11325-00A	6G8-11325-00	ÁNODO	ANODE	ANODO	ANODE	3
27	PAGB/T3452.1-13X2	93210-13M63	TÓRICA	O-RING	O-RING	JOINT TORIQUE	3
28	PAF20-05030009	6G8-11197-01	TAPÓN	CAP	TAPPO	BOUCHON	3
29	NGKLR7E	94702-00429	BUJÍA	SPARK PLUG	CANDELA	BOUGIE	4
30	PAF25-00000014	99530-08012	PIN CENTRADOR	HOLLOW PIN	SPINOTTO DI CENTRAGGIO	PIN DE CENTRAGE	2
31	PAF25-05020204	6C5-11654-00	TORNILLO	SCREW	VITE	VIS	2
32	PAF25-05020200	6C5-11650-10	BIELA COMPLETA	ROD, CONNECTING ASSY	BIELLA COMPLETA	BIELLE COMPLÈTE	4
33	PAF25-05020106	93450-17129	CIRCLIP	CIRCLIP	CIRCLIP	CIRCLIP	8
34	PAF25-05020105	62Y-11633-00	PIN, PISTÓN	PIN, PISTON	SPINOTTO PISTONE	AXE DE PISTON	4
35	REC67C-11603-00	67C-11603-00	KIT SEGMENTOS DE PISTÓN	PISTON RING KIT	KIT FASCIA PISTONE	KIT DE SEGMENTS	4
36	PAGB/T1099-3X5X13	90280-03M01	CHAVETA	KEY WOODRUFF	CHIAVETTA	CLAVETTE	1
37	PAF25-05050021	93102-37M40	RETÉN DE ACEITE	OIL SEAL	PARAOLIO	JOINT SPI	1
38	REC6C5-46241-00	6C5-46241-00	CORREA DISTRIBUCIÓN	BELT, TIMING	CINGHIA DISTRIBUZIONE	COURROIE DISTRIBUTION	1
39	PAPS2700.04.03	51Y-12119-00	RETÉN DE ACEITE	OIL SEAL	PARAOLIO	JOINT SPI	16
40	PAF15-07040304	62Y-12158-00	TUERCA	LOCK NUT	DADO	ÉCROU	8



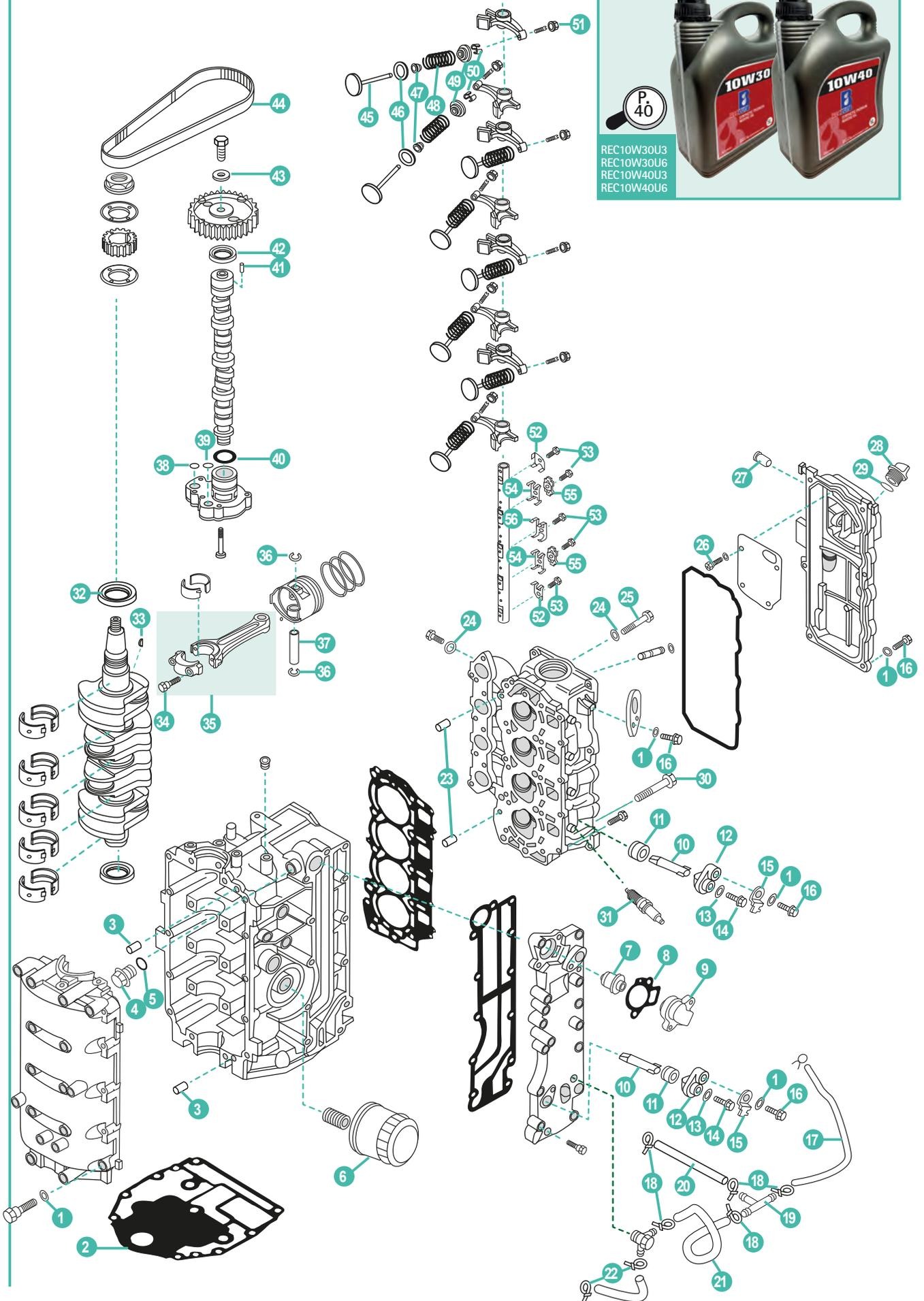



	REF	OEM					UN.
1	PAGB/T97.1-6	92903-06600	ARANDELA	WASHER	RONDELLA	RONDELLE	22
2	REC67C-11351-00	67C-11351-01	JUNTA BASE MOTOR	GASKET ENGINE	GUARNIZIONE BASE MOTORE	JOINT MOTEUR	1
3	REC93606-12019	93606-12019	PIN CENTRADOR	HOLLOW PIN	SPINOTTO DI CENTRAGGIO	PIN DE CENTRAGE	4
4	PAF15-04000002	90340-14M06	TORNILLO DRENAJE	BOLT, DISCHARGING OIL	VITE DRENAGGIO	VIS DE VIDANGE	1
5	PAF15-04000003	90430-14115	TÓRICA	O-RING	O-RING	JOINT TORIQUE	1
6	REC5GH-13440-00	5GH-13440-10	FILTRO ACEITE	OIL FILTER	FILTRO DELL'OLIO	FILTRE À HUILE	1
7	PAF15-07000031	6G8-12411-03	TÓRICA	O-RING	O-RING	JOINT TORIQUE	1
8	REC6H3-12414-A1	62Y-12414-00	JUNTA TAPA TERMOSTATO	GASKET, THERMOSTAT COVER	GUARNIZIONE COPERCHIO TERMOSTATO	JOINT COUVERCLE DE THERMOSTAT	1
9	PAF15-07010021	6H3-12413-00-1S	TAPA TERMOSTATO	COVER, THERMOSTAT	COPERCHIO TERMOSTATO	COUVERCLE DE THERMOSTAT	1
10	CM62Y-11325-00A	62Y-11325-00	ÁNODO	ANODE	ANODO	ANODE	2
11	PAF15-07010009	66M-11328-00	TAPÓN	CAP	TAPPO	BOUCHON	2
12	PAF15-07010011	66M-11327-00-94	TAPA ÁNODO	COVER, ANODE	COPERTURA ANODO	COUVERCLE DU ANODE	2
13	PAGB/T97.1-5	92995-05600	ARANDELA	WASHER	RONDELLA	RONDELLE	1
14	PAGB/T818-M5X12	97095-05012	PERNO	STUD	BULLONE	BOULON	1
15	PAF15-07010012	66M-12535-00	EMPAQUETADORA DE ÁNODO	PLATE, ANODE	PIASTRA ANODO	PLAQUE D'ANODE	1
16	PAGB/T5783-M6X20	97095-06020	PERNO	STUD	BULLONE	BOULON	12
17	PAF15-05000014	90445-09104	TUBO DE AGUA	WATER TUBE	TUBO DELL'ACQUA	DURITE D'EAU	1
18	PAHT-2.5X60	90465-11M10	BRIDA	CLAMP	FLANGIA	COLLIER	5
19	PAF15-05000011	688-24378-00	CONECTOR DE 3 VÍAS	THREE-WAY PIPE	CONNETTORE T	TE	1
20	PAF25-03000009	90445-09095	TUBO DE AGUA	WATER TUBE	TUBO DELL'ACQUA	DURITE D'EAU	1
21	PAF25-03000008	90445-09068	TUBO DE AGUA	WATER TUBE	TUBO DELL'ACQUA	DURITE D'EAU	1
22	PAHT-2.5X60	90465-11M10	BRIDA	CLAMP	FLANGIA	COLLIER	2
23	PAF25-00000014	99530-08012	PIN CENTRADOR	HOLLOW PIN	SPINOTTO DI CENTRAGGIO	PIN DE CENTRAGE	2
24	PAF25-05050007	90430-06014	JUNTA	GASKET	GUARNIZIONE	JOINT	5
25	PAF25-05050006	90109-06M65	TORNILLO	SCREW	VITE	VIS	1
26	PAGB/T818-M4X10	98507-04010	TORNILLO	SCREW	VITE	VIS	4
27	PAF40-05070002	62Y-14485-00	PIPA DE AGUA	PIPE, WATER	TUBO	RACCORD TUYAU D'EAU	1
28	PAF15-07050004	6G8-15363-00	TAPÓN ACEITE	PLUG, OIL	TAPPO OLIO	BOUCHON REMPLISSAGE D'HUILE	1
29	PAJASOF40431-025	93210-24M79	TÓRICA	O-RING	O-RING	JOINT TORIQUE	1
30	PAF25-05000002	90119-09M00	TORNILLO CON ARANDELA	BOLT, FLANGE	VITE CON RONDELLA	VIS DE BRIDE	10
31	NGKDPR6EA-9	94701-00375	BUJÍA	SPARK PLUG	CANDELA	BOUGIE	4
32	PAF25-05020003	93102-43M42	RETÉN DE ACEITE	OIL SEAL	PARAOLIO	JOINT SPI	1
33	PAF4-04000019	90280-04M06	CUÑA	KEY WOODRUFF	CHIAVETTA	CLAVETTE	1
34	PAF25-05020204	6C5-11654-00	TORNILLO	SCREW	VITE	VIS	2
35	PAF25-05020200	6C5-11650-00	BIELA COMPLETA	ROD, CONNECTING ASSY	BIELLA COMPLETA	BIELLE COMPLÈTE	4
36	PAF25-05020106	93450-17129	CIRCLIP	CIRCLIP	CIRCLIP	CIRCLIP	8
37	PAF25-05020105	62Y-11633-00	PIN, PISTÓN	PIN, PISTON	SPINOTTO PISTONE	AXE DE PISTON	4
38	PAF25-05050014	93210-14515	PISTÓN, CONTRA	PISTON, BALANCE	PISTONE, CONTRO	PISTON D'EQUILIBRAGE	1
39	PAF25-05050013	93210-12MG9	TÓRICA	O-RING	O-RING	JOINT TORIQUE	1
40	PAF25-05050015	93210-33MH2	TÓRICA	O-RING	O-RING	JOINT TORIQUE	1
41	PAF25-05050016	93605-14143	PIN CENTRADOR	HOLLOW PIN	SPINOTTO DI CENTRAGGIO	PIN DE CENTRAGE	1
42	PAF25-05050021	93102-37M40	RETÉN DE ACEITE	OIL SEAL	PARAOLIO	JOINT SPI	1
43	PAF25-05050018	90201-10M06	ARANDELA	WASHER	RONDELLA	RONDELLE	1
44	REC62Y-46241-00	62Y-46241-00	CORREA DISTRIBUCIÓN	BELT, TIMING	CINGHIA DISTRIBUZIONE	COURROIE DISTRIBUTION	1
45	PAF25-05050002	62Y-12121-00	VÁLVULA ESCAPE	VALVE, EXHAUST	VALVOLA SCARICO	SOUPAPE D'ÉCHAPPEMENT	4
46	PAF25-05050003	62Y-12116-00	ARANDELA ASIENTO	SEAT, VALVE SPRING	RONDELLA BASAMENTO	SIEGE RESSORT DE SOUPAPE	8
47	PAPS2700.04.03	51Y-12119-00	RETÉN DE ACEITE	OIL SEAL	PARAOLIO	JOINT SPI	8
48	PAF25-05050005	51Y-12114-00	MUELLE DE VÁLVULA	SPRING, VALVE STEM	MOLLA DI VALVOLA	RESSORT DE SOUPAPE	8
49	PAF15-07040006	30X-12117-00	RETÉN RESORTE	SPRING, VALVE RETAINER	VALVOLA DI RITEGNO	JOINT DE RESSORT	8
50	PAF15-07040007	30X-12118-00	SEGURO DE VÁLVULA	CLAMP, VALVE	BLOCCAGGIO DI VALVOLA	CLAVETTE DE SOUPAPE	16
51	PAF15-07040304	62Y-12158-00	TUERCA	LOCK NUT	DADO	ÉCROU	8
52	PAF25-05050009	62Y-12238-00	PLACA TOPE DE PERNO	PLATE, BOLT STOPPER	PIASTRA DE VITE	PLAQUE DE FIXATION	2
53	PAF25-05050019	90109-08M63	TORNILLO	SCREW	VITE	VIS	5
54	PAF25-05050011	62Y-12216-00	RESORTE	SPRING	MOLLA	RESSORT	14
55	PAF25-05050012	62Y-12231-00	TOPE DE GUÍA	PLATE, BOLT STOPPER	PIASTRA DE GUIDA	PLAQUE DE FIXATION	2
56	PAF40-05040003	62Y-12279-00	PLACA EJE DE BALANCINES	FIXED PLATE B, ROCKER SHAFT	PIASTRA, ASSE BILANCERE	PLAQUE ARBRE DE CULBUTEUR	1

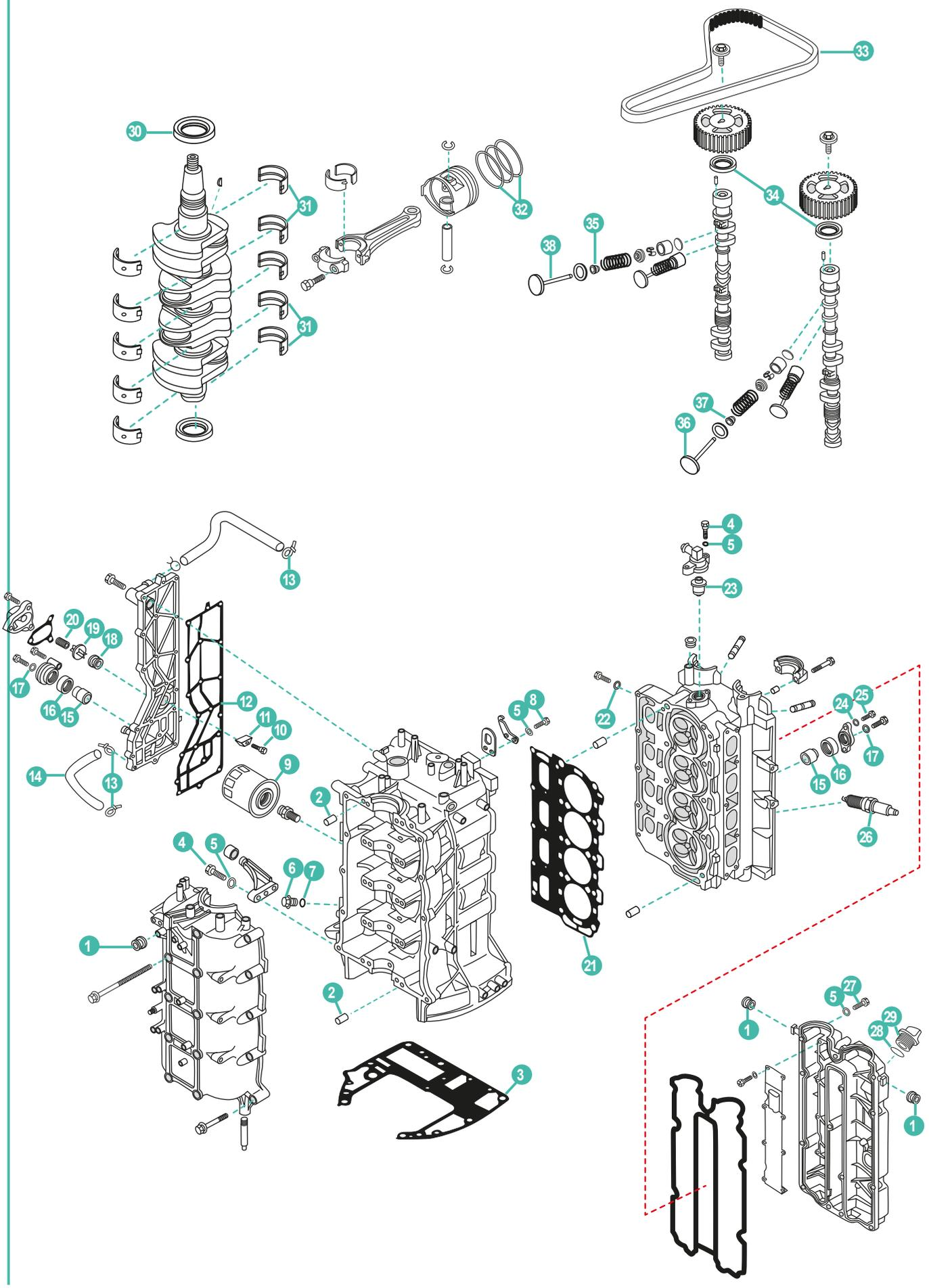

	REF	OEM				UN.	
1	PAF15-07010027	90480-12072	TAPÓN	CAP	TAPPO	BOUCHON	3
2	REC93606-12019	93606-12019	PIN CENTRADOR	HOLLOW PIN	SPINOTTO DI CENTRAGGIO	PIN DE CENTRAGE	24
3	REC68V-11351-00	68V-11351-00	JUNTA BASE MOTOR	GASKET ENGINE	GUARNIZIONE BASE MOTORE	JOINT MOTEUR	1
4	PAGB/T5782-M6X25	97095-06025	TORNILLO	SCREW	VITE	VIS	6
5	PAGB/T97.1-6	92995-06600	ARANDELA	WASHER	RONDELLA	RONDELLE	24
6	PAF15-04000002	90340-14M06	TORNILLO DRENAJE	BOLT, DISCHARGING OIL	VITE DRENAGGIO	VIS DE VIDANGE	1
7	PAF15-04000003	90430-14115	TÓRICA	O-RING	O-RING	JOINT TORIQUE	1
8	PAGB/T5783-M6X20	97095-06020	TORNILLO	SCREW	VITE	VIS	4
9	REC5GH-13440-00	5GH-13440-00	FILTRO ACEITE	OIL FILTER	FILTRO DELL'OLIO	FILTRE À HUILE	1
10	PAGB/T820-M4X12	98780-04016	TORNILLO	SCREW	VITE	VIS	3
11	CM15026A	6E5-11325-00	ÁNODO	ANODE	ANODO	ANODE	3
12	REC67F-41114-A2	6D8-41114-A0	JUNTA	GASKET	GUARNIZIONE	JOINT	1
13	PAHT-2.5X60	90465-11M10	BRIDA	CLAMP	FLANGIA	COLLIER	3
14	PAF40-05000053	90445-10M40	TUBO	TUBE	TUBO	DURITE	1
15	CM68V-11325-01A	68V-11325-02	ÁNODO	ANODE	ANODO	ANODE	2
16	REC67F-11328-00	67F-11328-00	TAPÓN	CAP	TAPPO	BOUCHON	2
17	REC90430-06M03	90430-06M03	JUNTA	GASKET	GUARNIZIONE	JOINT	2
18	REC90480-20M05	90480-20M05	TAPÓN	CAP	TAPPO	BOUCHON	1
19	REC60H-12416-00	6G5-12416-00	VÁLVULA CONTROL DE PRESIÓN	VALVE, PRESSURE CONTROL	VALVOLA ANTIPRESSIONE	SOUPAPE DE DEPRESSION	1
20	REC90501-16M11	90501-16M11	RESORTE	SPRING	MOLLA	RESSORT	1
21	REC67F-11181-03	67F-11181-02	JUNTA CULATA	GASKET, CYLINDER HEAD	GUARNIZIONE TESTATA	JOINT DE CULASSE	1
22	PAF4-04000006	90430-08143	JUNTA	GASKET	GUARNIZIONE	JOINT	4
23	REC67F-12411-01	67F-12411-01	TERMOSTATO	THERMOSTAT	TERMOSTATO	THERMOSTAT	1
24	PAGB/T97.1-8	92995-08600	ARANDELA	WASHER	RONDELLA	RONDELLE	4
25	PAGB/T5783-M8X25	97075-08025	PERNO	STUD	BULLONE	BOULON	4
26	NGKLF5A-11	94702-00391	BUJÍA	SPARK PLUG	CANDELA	BOUGIE	4
27	REC90101-06M56	97095-06030	TORNILLO	SCREW	VITE	VIS	14
28	PAJASOF40431-025	93210-24M79	TÓRICA	O-RING	O-RING	JOINT TORIQUE	1
29	PAF15-07050004	6G8-15363-00	TAPÓN ACEITE	PLUG, OIL	TAPPO OLIO	BOUCHON REMPLISSAGE D'HUILE	1
30	REC93102-48009	93102-48009	RETÉN DE ACEITE	OIL SEAL	PARAOLIO	JOINT SPI	1
31	REC67F-11416-00	67F11416-00	COJINETE PLANO 1 VERDE	MAIN BEARING 1 GREEN	CUSCINETTO 1 VERDE	PALIER 1 VERT	4
	REC67F-11416-10	67F11416-10	COJINETE PLANO 1 AZUL	MAIN BEARING 1 BLUE	CUSCINETTO 1 BLUE	PALIER 1 BLEU	4
	REC67F-11416-20	67F11416-20	COJINETE PLANO 1 ROJO	MAIN BEARING 1 RED	CUSCINETTO 1 ROSSO	PALIER 1 ROUGE	4
32	REC6D8-11603-10	6D8-11603-01	KIT SEGMENTOS DE PISTÓN 200-300	PISTON RING KIT 200-300	KIT FASCIA PISTONE 200-300	KIT DE SEGMENTS 200-300	4
	REC6D8-11604-10	6D8-11604-01	KIT SEGMENTOS DE PISTÓN 0.25mm O/S	PISTON RING KIT 0.25mm O/S	KIT FASCIA PISTONE 0.25mm O/S	KIT DE SEGMENTS 0.25 mm O/S	4
33	REC67F-46241-00	67F-46241-00	CORREA	BELT	CINGHIA	COURROIE DISTRIBUTION	1
34	REC93102-38008	93102-38M59	RETÉN DE ACEITE	OIL SEAL	PARAOLIO	JOINT SPI	2
35	RECK0A-A3722-00	K0A-A3722-00	RETÉN DE ACEITE	OIL SEAL	PARAOLIO	JOINT SPI	8
36	REC68V-12111-00	68V-12111-00	VÁLVULA ADMISIÓN	VALVE, INTAKE	VALVOLA ASPIRAZIONE	SOUPAPE D ADMISSION	8
37	RECK0A-A3721-00	K0A-A3721-00	RETÉN DE ACEITE	OIL SEAL	PARAOLIO	JOINT SPI	8

**4T** F80B/C, F100/B/D, F115A  
STROKES

	REF	OEM				UN.	
36	REC6D8-12111-00	6D8-12111-00	VÁLVULA DE ADMISIÓN Ø96,75mm	VALVE, INTAKE Ø96,75mm	VALVOLA ASPIRAZIONE Ø96,75mm	SOUPAPE D ADMISSION Ø96,75mm	8
38	REC6D8-12121-10	6D8-12121-10	VÁLVULA DE ESCAPE Ø98,95 mm	VALVE, EXHAUST Ø98,95 mm	VALVOLA SCARICO Ø98,95 mm	SOUPAPE D'ECHAPPEMENT Ø98,95 mm	8

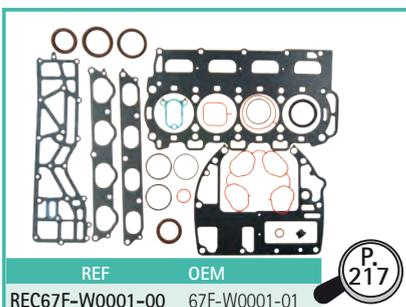

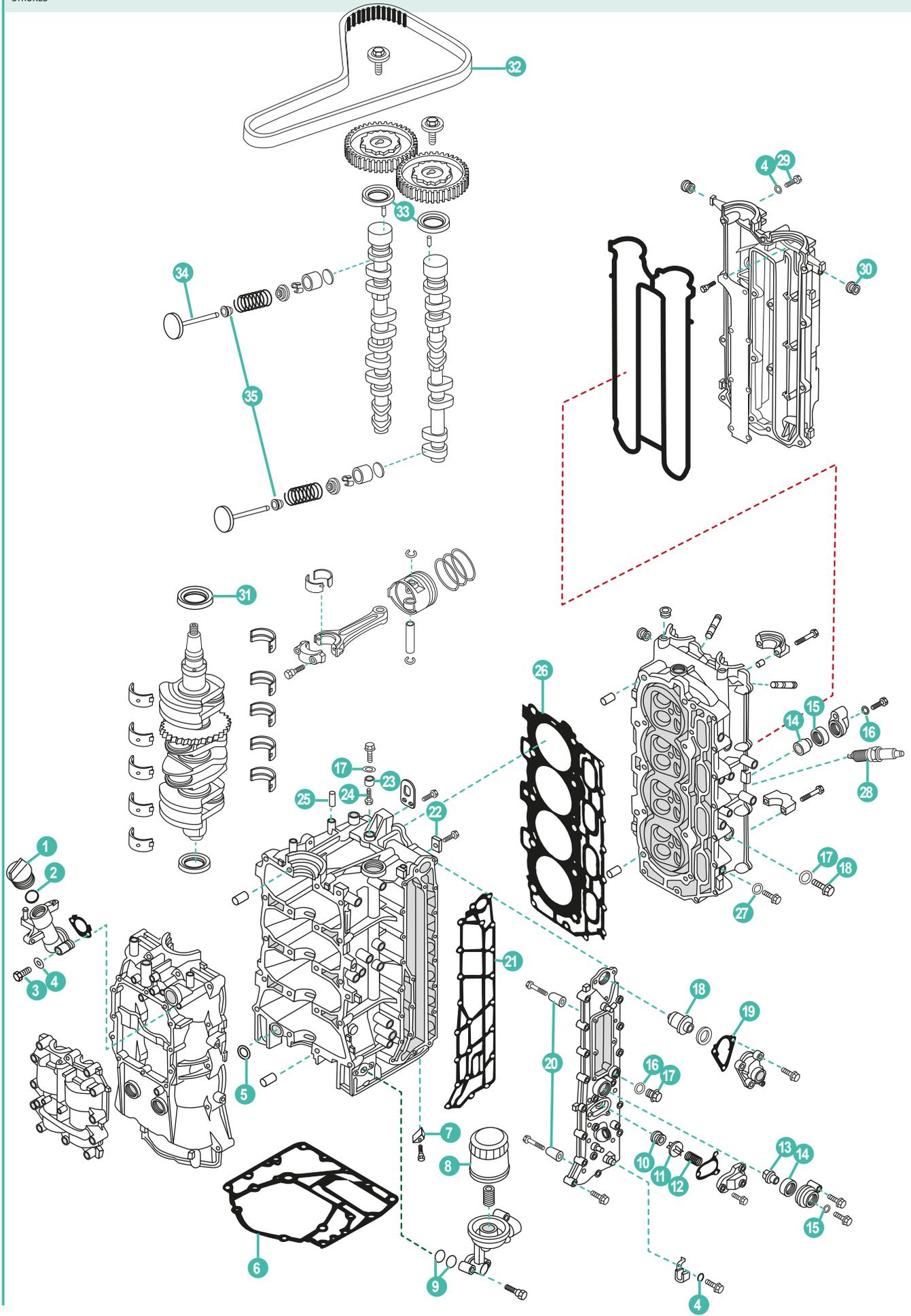

	REF	OEM					UN.
1	PAF15-07050004	6G8-15363-00	TAPÓN ACEITE	PLUG, OIL	TAPPO OLIO	BOUCHON REMPLISSAGE D'HUILE	1
2	PAJASOF40431-025	93210-24M79	TÓRICA	O-RING	O-RING	JOINT TORIQUE	1
3	REC97095-06045	97095-06045	TORNILLO	SCREW	VITE	VIS	2
4	PAGB/T97.1-6	92995-06600	ARNADELA	WASHER	RONDELLA	RONDELLE	15
5	REC93210-25552	93210-25552	TÓRICA	O-RING	O-RING	JOINT TORIQUE	1
6	REC63P-11351-01	63P-11351-00	JUNTA BASE MOTOR	GASKET ENGINE	GUARNIZIONE BASE MOTORE	JOINT MOTEUR	1
7	CM63P-11325-01A	63P-11325-01	ÁNODO	ANODE	ANODO	ANODE	1
8	REC35-822626Q15	69J-13440-01	FILTRO ACEITE	OIL FILTER	FILTRO DELL'OLIO	FILTRE À HUILE	1
9	REC93210-19MJ1	93210-19MJ1	TÓRICA	O-RING	O-RING	JOINT TORIQUE	2
10	REC90480-20M05	90480-20M05	TAPÓN	CAP	TAPPO	BOUCHON	1
11	REC60H-12416-00	6G5-12416-00	VÁLVULA DE PRESIÓN	VALVE, PRESSURE CONTROL	VALVOLA ANTIPRESSIONE	SOUPAPE DE DEPRESSION	1
12	REC90501-16M11	90501-16M11	RESORTE	SPRING	MOLLA	RESSORT	1
13	CM67F-11325-01A	67F-11325-01	ÁNODO	ANODE	ANODO	ANODE	2
14	REC67F-11328-00	67F-11328-00	TAPÓN	CAP	TAPPO	BOUCHON	2
15	REC90430-06M03	90430-06M03	JUNTA	GASKET	GUARNIZIONE	JOINT	2
16	PAF15-04000003	90430-14115	JUNTA	GASKET	GUARNIZIONE	JOINT	1
17	PAF15-04000002	90340-14M06	TORNILLO DRENAJE	BOLT, DISCHARGING OIL	VITE DRENAGGIO	VIS DE VIDANGE	1
18	REC67F-12411-01	67F-12411-01	TERMOSTATO	THERMOSTAT	TERMOSTATO	THERMOSTAT	1
19	REC63P-12414-00	63P-12414-00	JUNTA TAPA TERMOSTATO	GASKET, THERMOSTAT COVER	GUARNIZIONE COPERCHIO TERMOSTATO	JOINT COUVERCLE DE THERMOSTAT	1
20	CM68T-11325-00A	68T-11325-00	ÁNODO	ANODE	ANODO	ANODE	8
21	REC63P-41114-A3	63P-41114-A1	JUNTA	GASKET	GUARNIZIONE	JOINT	1
22	CM63P-11325-11A	63P-11325-11	ÁNODO	ANODE	ANODO	ANODE	4
23	TEN01165	63P-11325-21	ÁNODO	ANODE	ANODO	ANODE	1
24	PAGB/T818-M5X16	98780-05016	TORNILLO	SCREW	VITE	VIS	1
25	REC93606-12019	93606-12019	PIN CENTRADOR	HOLLOW PIN	SPINOTTO DI CENTRAGGIO	PIN DE CENTRAGE	1
26	REC63P-11181-00	63P-11181-00	JUNTA CULATA	GASKET, CYLINDER HEAD	GUARNIZIONE TESTATA	JOINT DE CULASSE	1
27	PAF4-04000006	90430-08143	JUNTA	GASKET	GUARNIZIONE	JOINT	4
28	NGKFR5A-11	94702-00391	BUJÍA	SPARK PLUG	CANDELA	BOUGIE	4
29	PAGB/T5783-M6X30	97095-06030	TORNILLO	SCREW	VITE	VIS	13
30	PAF15-07010027	90480-12072	TAPÓN	CAP	TAPPO	BOUCHON	5
31	REC93102-60004	93102-60004	RETÉN DE ACEITE	OIL SEAL	PARAOLIO	JOINT SPI	1
32	REC63P-46241-00	63P-46241-00	CORREA DISTRIBUCIÓN	BELT, TIMING	CINGHIA DISTRIBUZIONE	COURROIE DISTRIBUTION	1
33	REC93102-38008	93102-38008	RETÉN DE ACEITE	OIL SEAL	PARAOLIO	JOINT SPI	2
34	REC69J-12111-00	69J-12111-00	VÁLVULA ADMISIÓN Ø92.5 mm	VALVE, INTAKE Ø92.5 mm	VALVOLA ASPIRAZIONE Ø92.5 mm	SOUPAPE D ADMISSION Ø92.5 mm	8
35	REC69J-12119-00	69J-12119-00	RETÉN DE ACEITE	OIL SEAL	PARAOLIO	JOINT SPI	16



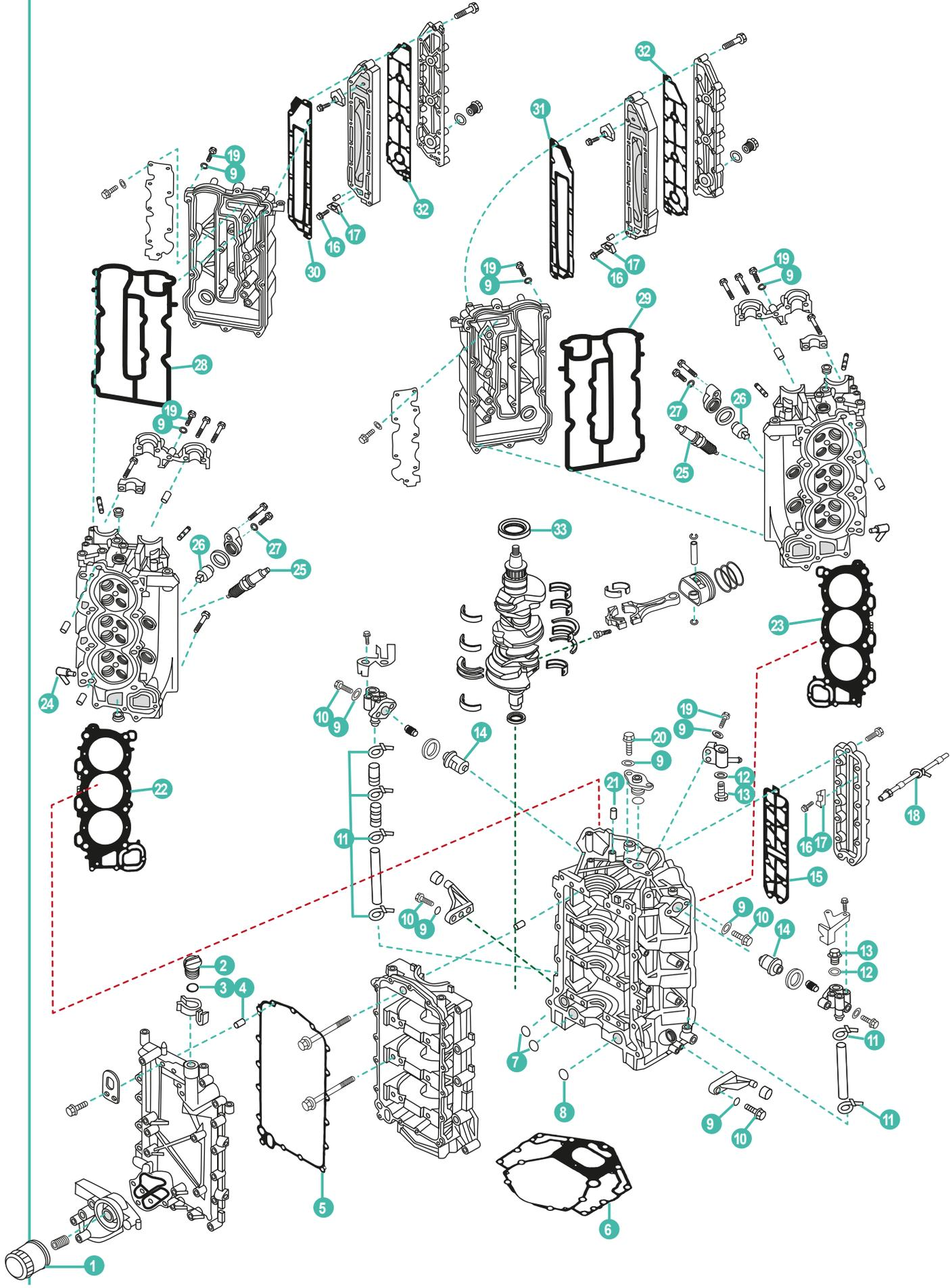

	REF	OEM					UN.
1	REC35-822626Q15	69J-13440-01	FILTRO ACEITE	OIL FILTER	FILTRO DELL'OLIO	FILTRE À HUILE	1
2	PAF15-07050004	6G8-15363-00	TAPÓN ACEITE	PLUG, OIL	TAPPO OLIO	BOUCHON REMPLISSAGE D'HUILE	1
3	PAJASOF40431-025	93210-24M79	TÓRICA	O-RING	O-RING	JOINT TORIQUE	1
4	REC93606-12019	93606-12019	PIN CENTRADOR	HOLLOW PIN	SPINOTTO DI CENTRAGGIO	PIN DE CENTRAGE	2
5	REC69J-15451-00	69J-15451-00	JUNTA	GASKET	GUANIZIONE	JOINT	1
6	REC69J-11351-11	69J-11351-11	JUNTA BASE MOTOR	GASKET ENGINE	GUARNIZIONE BASE MOTORE	JOINT MOTEUR	1
7	REC93210-19MJ1	93210-19MJ1	TÓRICA	O-RING	O-RING	JOINT TORIQUE	2
8	REC93210-25552	93210-25552	TÓRICA	O-RING	O-RING	JOINT TORIQUE	1
9	PAGB/T97.1-6	92995-06600	ARANDELA	WASHER	RONDELLA	RONDELLE	28
10	PAGB/T5782-M6X25	97095-06025	TORNILLO	SCREW	VITE	VIS	8
11	REC09401-11425	90465-11M59	BRIDA	CLAMP	FLANGIA	COLLIER	6
12	PAF15-04000003	90430-14115	JUNTA	GASKET	GUARNIZIONE	JOINT	2
13	PAF15-04000002	90340-14M06	TORNILLO DRENAJE	BOLT, DISCHARGING OIL	VITE DRENAGGIO	VIS DE VIDANGE	2
14	REC67F-12411-01	67F-12411-01	TERMOSTATO	THERMOSTAT	TERMOSTATO	THERMOSTAT	2
15	REC6P2-1131B-00	6P2-1131B-00	JUNTA (NO SERIE A)	GASKET (NO SERIAL A)	GUARNIZIONE (NO SERIE A)	JOINT (NO SÉRIE A)	1
16	PAGB/T820-M4X12	98780-04015	TORNILLO	SCREW	VITE	VIS	6
17	CM15026A	6E5-11325-00	ÁNODO	ANODE	ANODO	ANODE	6
18	PAHT-2.5X60	90465-11M10	BRIDA	CLAMP	FLANGIA	COLLIER	1
19	PAGB/T5783-M6X30	97095-06030	TORNILLO	SCREW	VITE	VIS	18
20	PAGB/T5783-M6X20	97095-06020	TORNILLO	SCREW	VITE	VIS	2
21	REC93606-12019	93606-12019	PIN CENTRADOR	HOLLOW PIN	SPINOTTO DI CENTRAGGIO	PIN DE CENTRAGE	1
22	REC6P2-11181-00	6P2-11181-00	JUNTA CULATA 1	GASKET, CYLINDER HEAD 1	GUARNIZIONE TESTATA 1	JOINT DE CULASSE 1	1
23	REC6P2-11182-00	6P2-11182-00	JUNTA CULATA 2	GASKET, CYLINDER HEAD 2	GUARNIZIONE TESTATA 2	JOINT DE CULASSE 2	1
24	PAF15-04000005	676-11372-00	NIPLE DE MANGUERA	NIPPLE	TUBO	RACCORD D'EAU	1
25	NGKLF6A-11	94702-00400	BUJÍA	SPARK PLUG	CANDELA	BOUGIE	6
26	CM67F-11325-01A	67F-11325-01	ÁNODO	ANODE	ANODO	ANODE	2
27	REC90430-06M03	90430-06M03	JUNTA	GASKET	GUARNIZIONE	JOINT	2
28	REC6P2-11193-00	6P2-11193-00	JUNTA TAPA DE CULATA 1	GASKET, CYLINDER HEAD COVER 1	GUARNIZIONE, COPERCHIO TESTATA 1	JOINT DE CACHE CULBUTEUR 1	1
29	REC6P2-11194-00	6P2-11194-00	JUNTA TAPA DE CULATA 2	GASKET, CYLINDER HEAD COVER 2	GUARNIZIONE, COPERCHIO TESTATA 2	JOINT DE CACHE CULBUTEUR 2	1
30	REC6P2-41122-00	6P2-41122-00	JUNTA	GASKET	GUARNIZIONE	JOINT	1
31	REC6P2-41112-00	6P2-41112-00	JUNTA	GASKET	GUARNIZIONE	JOINT	1
32	REC6P2-41114-00	6P2-41114-00	JUNTA	GASKET	GUARNIZIONE	JOINT	2
33	REC93102-63004	93102-63008	RETÉN DE ACEITE	OIL SEAL	PARAOLIO	JOINT SPI	1
34	PAPS2700.04.03	51Y-12119-00	RETÉN DE ACEITE	OIL SEAL	PARAOLIO	JOINT SPI	24
35	REC93102-38008	93102-38008	RETÉN DE ACEITE	OIL SEAL	PARAOLIO	JOINT SPI	4
36	REC6P2-46241-02	6P2-46241-01	CORREA DISTRIBUCIÓN	BELT, TIMING	CINGHIA DISTRIBUZIONE	COURROIE DISTRIBUTION	1

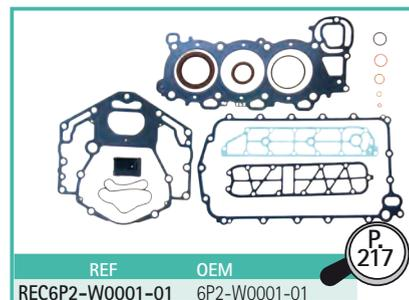
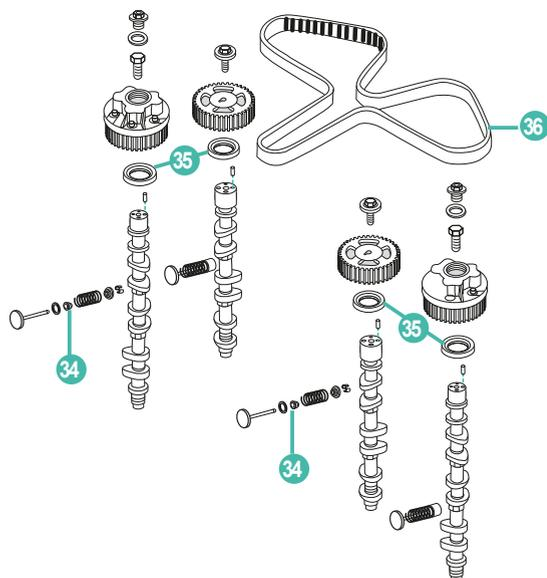

4T F300A • F350A  
STROKES



REC10W30U3  
REC10W30U6  
REC10W40U3  
REC10W40U6

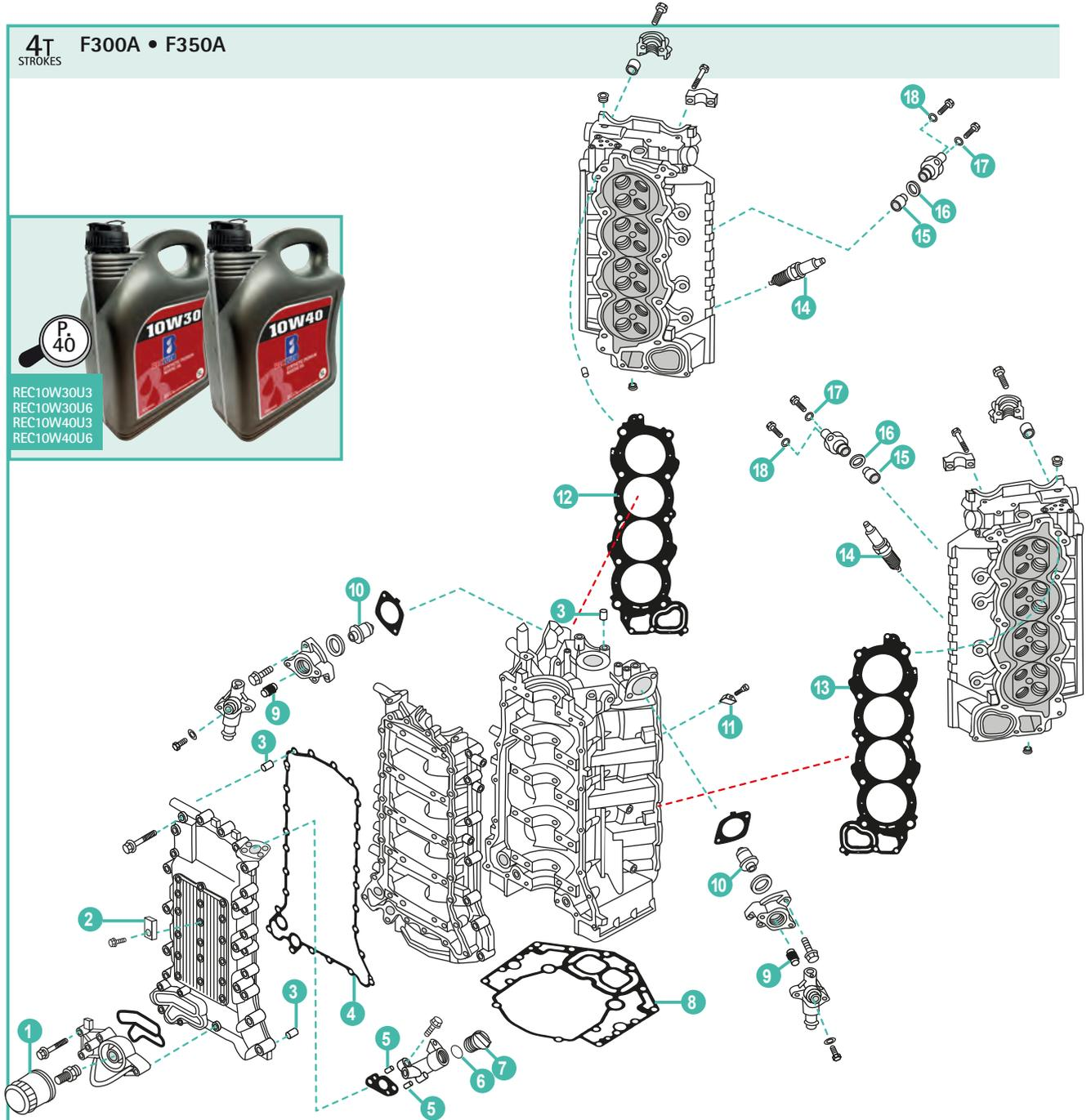

	REF	OEM					UN.
1	REC N26-13440-00	N26-13440-00	FILTRO ACEITE	OIL FILTER	FILTRO DELL'OLIO	FILTRE À HUILE	1
2	CM63P-11325-01A	63P-11325-01	ÁNODO	ANODE	ANODO	ANODE	3
3	REC93606-12019	93606-12019	PIN CENTRADOR	HOLLOW PIN	SPINOTTO DI CENTRAGGIO	PIN DE CENTRAGE	5
4	REC6AW-15451-00	6AW-15451-00	JUNTA CÁRTER	CRANK CASE COMPLEX GASKET	GUARNIZIONE COPPA L'OLLIO	JOINT DE CACHE CULBUTEUR	1
5	PAF25-04000007	93604-08062	PIN CENTRADOR	HOLLOW PIN	SPINOTTO DI CENTRAGGIO	PIN DE CENTRAGE	2
6	PAJASOF40431-025	93210-24M79	TÓRICA	O-RING	O-RING	JOINT TORIQUE	1
7	PAF15-07050004	6G8-15363-00	TAPÓN ACEITE	PLUG, OIL	TAPPO OLIO	BOUCHON REMPLISSAGE D'HUILE	1
8	REC6AW-11351-00	6AW-11351-00	JUNTA BASE MOTOR	GASKET ENGINE	GUARNIZIONE BASE MOTORE	JOINT DE TETE MOTRICE	1
9	TEN01172	6AW-1132R-00	ÁNODO	ANODE	ANODO	ANODE	2
10	REC6AW-12411-00	6AW-12411-00	TERMOSTATO	THERMOSTAT	TERMOSTATO	THERMOSTAT	2
11	TEN01177	6AW-1132P-00	ÁNODO	ANODE	ANODO	ANODE	8
12	REC6AW-11182-00	6AW-11182-00	JUNTA DE CULATA 2	HEAD GASKET 2	GUARNIZIONE TESTATA 2	JOINT DE CULASSE 2	1
13	REC6AW-11181-00	6AW-11181-00	JUNTA DE CULATA 1	HEAD GASKET 1	GUARNIZIONE TESTATA 1	JOINT DE CULASSE 1	1
14	NGK LFR6A-11	94702-00400	BUJÍA	SPARK PLUG	CANDELE	BOUGIE	8
15	TEN01170	6AW-11325-00	ÁNODO	ANODE	ANODO	ANODE	2
16	REC67F-11328-00	67F-11328-00	TAPÓN	CAP	TAPPO	BOUCHON	2
17	REC90430-06M03	90430-06M03	JUNTA	GASKET	GUARNIZIONE	JOINT	2
18	PAGB/T97.1-8	92995-08600	ARANDELA	WASHER	RONDELLA	RONDELLE	2



4T  
STROKES

JUNTAS DE MOTOR  
4 TIEMPOS

ENGINE GASKET  
4 STROKES

GUARNIZIONI DE  
MOTORE 4 TEMPI

JOINTS DE MOTEUR  
4 TEMPS

JUNTAS DE CULATA

CYLINDER HEAD GASKET

GUARNIZIONE DE TESTATA

JOINTS DE CULASSE

REF	OEM
PAF2.6-04000001	69M-11181-00

F2.5 (2003+)



P. 173

REF	OEM
PAF4-04000014	67D-11181-A0

F4 (1998-2009)



P. 175

REF	OEM
PAF6-04000002	6BX-11181-00

F4B/M (2010+)  
F5A/M (2010+)  
F6C/M (2010+)



new

P. 176

REF	OEM
REC6G8-11181-A1	6G8-11181-A1

F8/9.9 (1985-05)



P. 181

REF	OEM
PAF15-07000100	66M-11181-10

F9.9/13.5/15 (1998-08)



P. 185

REF	OEM
REC6AG-11181-00	6AG-11181-00

F9.9/15/20 (2007+)



P. 187

REF	OEM
REC6BL-11181-00	6BL-11181-00

F20/25  
FT25  
T25 (2009+)



P. 195

REF	OEM
PAF25-05040000	65W-11181-30

F20/25  
T25  
F45/50 (1998-09)



P. 191

REF	OEM
REC67C-11181-01	67C-11181-01

F30/40 (2000-09)

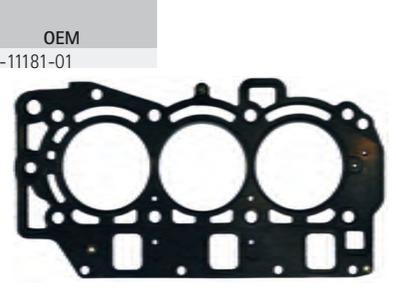

P. 197

REF	OEM
REC6BG-11181-00	6BG-11181-00

F30/40 (2009+)

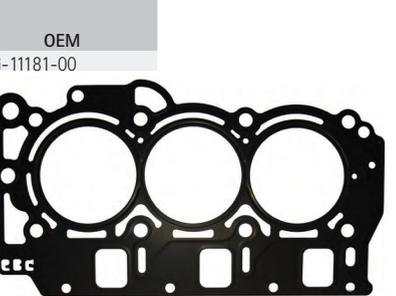

P. 201

REF	OEM
REC6CJ-11181-00	6CJ-11181-00

F40GE/70 (2011+)

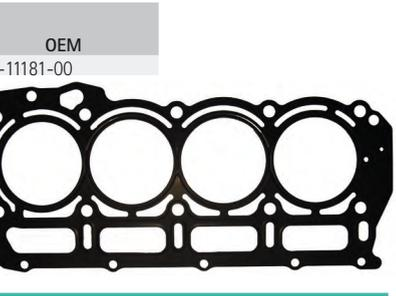

P. 205

REF	OEM
REC67F-11181-03	67F-11181-03

F75/80/100/115 (1999+)

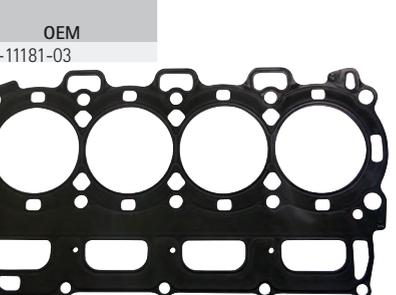

P. 209

REF	OEM
REC63P-11181-00	63P-11181-00

F150  
FL150 (2004+)



P. 211

YAMAHA

RECAMBIOS  
MARINOS

REF	OEM
REC6DA-11181-00	6DA-11181-00

F175/200  
FL200 (2013+)

REF	OEM
REC6CB-11181-00	6CB-11181-00

F225/250/300  
LF-FL225/250/300 (2011+)

REF	OEM
REC6P2-11182-00	6P2-11182-00
REC6P2-11181-00	6P2-11181-00

F200/225/250  
FL-LF 200/225/250 (2006-13)

P. 213

REC6P2-11182-00

REC6P2-11181-00

REF	OEM
REC6AW-11181-00	6AW-11181-00
REC6AW-11182-00	6AW-11182-00

F300/FL300  
(2008+)

P. 214

BABOR | PORT | BABORDO | GAUCHE  
ESTRIBOR | STD | TRIBORDO | DROIT

REC6AW-11181-00

REC6AW-11182-00

REF	OEM
REC69J-11182-03	69J-11182-03
REC69J-11181-03	69J-11181-03

F200/225  
FL200/225 (2002-07)

BABOR | PORT | BABORDO | GAUCHE  
ESTRIBOR | STD | TRIBORDO | DROIT

REC69J-11182-03

REC69J-11181-03

4T  
STROKES

**KITS JUNTAS DE CULATA**      **CYLINDER HEAD GASKET KIT**

REF	OEM
REC6G8-W0001-A3	6G8-W0001-A3

F9.9 (1996-06)  
F8BM (1996-99)

**KIT GUARNIZIONE TESTATA**      **KITS JOINTS DE CULASSE**

REF	OEM
REC66M-W0001-01	66M-W0001-01

F15 (2001-04)  
F13.5 (2002-04)  
FT 9.9/T9.9 (2001-04)  
F9.9 (2001-04)

REF	OEM
REC65W-W0001-00	65W-W0001-00

F20/25 (1998-01)  
T25/FT25 (2000-01)

REF	OEM
REC6P2-W0001-01	6P2-W0001-00 6P2-W0001-01

FL/LF/F250 AET/TX  
6P22 / 6P32 (2006)  
FL/F200C 6AL1-6AM6 (2006-11)  
FL/F225B/C 6AS1-6BBA (2007-11)  
LF/FL/F250A/B/T 6BR2-6P36 (2007-11)

REF	OEM
REC67C-W0001-01	67C-W0001-00 67C-W0001-01

F30 ALL  
F40ALL (2000-09)

REF	OEM
REC67F-W0001-00	67F-W0001-00

F75 (2003-17)  
F80 (1999-03)  
F100 (1999-03)  
F90 (2003-17)  
F115 (2000-15)

4T  
STROKES

JUNTAS BASE DE MOTOR CYLINDER GASKET

GUARNIZIONE  
BASE MOTORE

JOINTS DE TÊTE MOTRICE

REF	OEM
PAF2.6-00000003	69M-45113-A0

F2.5

REF	OEM
PAF15-00000014	66M-11351-10

T/FT9.9  
F9.9  
F15  
F13.5

REF	OEM
PAF6-00000001	6BX-45113-A0

F4/F5/F6

REF	OEM
REC6G8-11351-A0	6G8-11351-A0

T/FT 9.9  
F9.9  
F8

REF	OEM
PAF4-00000006	67D-45113-A0

F4

REF	OEM
PAF25-00000013	65W-11351-10

F20  
F25  
T/FT25

YAMAHA

RECAMBIOS  
MARINOS

REF	OEM
REC6AH-11351-00	6AH-11351-10

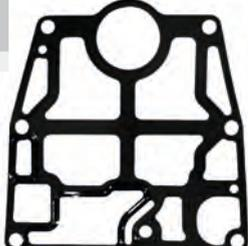

 F9.9  
 F13.5  
 F15  
 F20

REF	OEM
REC63P-11351-01	63P-11351-01

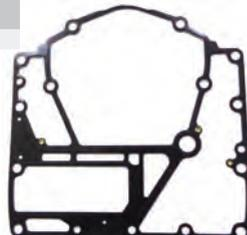

 F150  
 F175  
 F200

REF	OEM
REC67C-11351-00	67C-11351-01

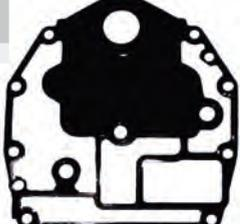

 F40  
 T/FT50  
 F50  
 T/FT60  
 F30  
 F60

REF	OEM
REC69J-11351-11	69J-11351-11



 F200  
 F225  
 F250

REF	OEM
REC68V-11351-00	68V-11351-00



 F75  
 F80  
 F90  
 F115  
 F100

REF	OEM
REC6AW-11351-00	6AW-11351-00

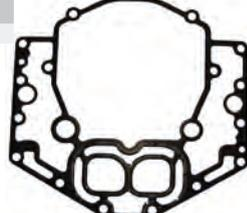

 F300  
 F350

4T  
STROKES

GUÍA JUNTAS DE MOTOR		ENGINE GASKET GUIDE		GUIDA GUARNIZIONE MOTORE		GUIDE JOINTS DE MOTEURS	
	CYL	JUNTA CULATA CYLINDER HEAD GASKET GUARNIZIONE TESTATA JOINT DE CULASSE		JUNTA BASE MOTOR CYLINDER GASKET GUARNIZIONE BASE MOTORE JOINT DE TETE MOTRICE			
			KIT		KIT		
F2.6A/M	2003	1	PAF2.6-04000001		PAF2.6-00000003		
F4A/M	1998	1	PAF4-04000014		PAF4-00000006		
F8A/B	1985-99	2	REC6G8-11181-A1	REC6G8-W0001-A3	REC6G8-11351-A0		
F9.9A/B	1985-99	2	REC6G8-11181-A1	REC6G8-W0001-A3	REC6G8-11351-A0		
F9.9C	2001-07	2	PAF15-07000100	REC66M-W0001-01	PAF15-00000014		
F9.9H	2008	2	REC6AG-11181-00		REC6AH-11351-00		
FT9.9D, F13.5 A	2001-07	2	PAF15-07000100	REC66M-W0001-01	PAF15-00000014		
F13.5B, F15C/E/M	2008	2	REC6AG-11181-00		REC6AH-11351-00		
F15A/E/M/P	2001-07	2	PAF15-07000100	REC66M-W0001-01	PAF15-00000014		
F20B/E/M	2008	2	REC6AG-11181-00		REC6AH-11351-00		
F20D	2011	2	REC6BL-11181-00				
F20A	1998	2	PAF25-05040000	REC65W-W0001-00	PAF25-00000013		
T25/F25A/A/E/M	1998-09	2	PAF25-05040000	REC65W-W0001-00	PAF25-00000013		
T25/F25D/M/F	2009	2	REC6BL-11181-00				
F30A/E/TR, F40B/E/TR	2000-09	3	REC67C-11181-01	REC67C-W0001-01	REC67C-11351-00		
F30B, F40F	2009	3	REC6BG-11181-00				
F40G, F70A	2011	4	REC6CJ-11181-00				
F80A/B/C/TLR	1999	4	REC67F-11181-03	REC67F-W0001-00	REC68V-11351-00		
F100A/B/D/TLR	1999	4	REC67F-11181-03	REC67F-W0001-00	REC68V-11351-00		
F115A/TX/TLR	2000	4	REC67F-11181-03	REC67F-W0001-00	REC68V-11351-00		
F150A/T/B	2004	4	REC63P-11181-00		REC63P-11351-01		
F17A	2014	4	REC6DA-11181-00		REC63P-11351-01		
F200A/TX/TR	2002-07	6	REC69J-11181-03 REC69J-11182-03		REC69J-11351-11		
F200A/C, F225A/B/C	2007	6	REC6P2-11181-00 REC6P2-11182-00	REC6P2-W0001-01	REC69J-11351-11		
F200B/F/G/CA	2013	4	REC6DA-11181-00		REC63P-11351-01		
F225A/TR/TX/TUR	2002-07	6	REC69J-11181-03 REC69J-11182-03		REC69J-11351-11		
F225CA/F, F250CA/D	2011	6	REC6CB-11181-00				
F250A/B/T	2009	6	REC6P2-11181-00 REC6P2-11182-00	REC6P2-W0001-01	REC69J-11351-11		
F300A/TR, F350A/C/T	2008	8	REC6AW-11181-00 REC6AW-11182-00		REC6AW-11351-00		
F300B/CA	2011	6	REC6CB-11181-00				

# CIGÜEÑAL

# CRANKSHAFT

# ALBERO MOTORE

# VILEBREQUIN

4T  
STROKES

## GUÍA CIGÜEÑAL COMPLETO

## GUIDE CRANKSHAFT ASSY

## GUIDA ALBERO MOTORE COMPLETO

## GUIDE VILEBREQUIN COMPLET

4T STROKES			4T STROKES		
	REF			REF	
F2.5	2003-13	PAF2.6-04030000	F15	2007-19	PAF20-05020004
F4	1998-09	PAF4-04030000	F20/AE/S/TL	2003-06	PAF25-05020001
F9.9	1998-09	PAF15-07030000	F20	2007-19	PAF20-05020004
F9.9	2009-19	PAF20-05020004	T25E/TL/R/B	2000-09	PAF25-05020001
F13.5	1999-07	PAF15-07030000	F25	1999-09	PAF25-05020001
F13.5	2007-09	PAF20-05020004	F45AET	1999	PAF25-05020001
F15	1998-07	PAF15-07030000	F50TJR	1999	PAF25-05020001

# PISTONES

# PISTONS

# PISTONI

# PISTONS

4T  
STROKES

## KITS DE PISTONES

## PISTON KITS

## KIT PISTONE

## KIT PISTON

	STD	
	REF	OEM
	PAF2.6-04020001	69M-E1631-01-96
	REC69M-E1603-01	69M-E1 603-01
	PAF2.6-04020005	69M-E1633-00
	F2.5AMH/MLH/MH/MSH (2004+)	



	STD	
	REF	OEM
	PAF20-05020001	6AH-11631-00
	PAF20-05020100	6AH-11603-00
	PAF20-05020003	137-11633-10
	PAF20-05020002	93450-17129
	F9.9 HMH, HE (2009+) F13.5 B, BMH (2007-09) F15 CMH, MH, ELH, CWH, CE (2007+) F20 BMH, ELH, BE, MH (2007+)	



	STD	
	REF	OEM
	PAF4-04020200	68D-E1631-00-96
	REC68D-E1603-00	68D-E1603-00
	PAF4-04020005	68D-E1633-00
	PAF4-04020006	93450-14088
	F4A/MSHA/AMH/MLHB-D/MH (2002-09)	



	STD	
	REF	OEM
	PAF25-05020100	65W-11631-00-96
	REC67C-11603-00	67C-11603-00
	PAF25-05020105	62Y-11633-00
	PAF25-05020106	93450-17129
	F20AES/AET/AE-S (2003-06) F25ELH/AE/AW/A/AET/MHZ/MHA/AM/AEH/A-ES/ T25ELRZ-T/FT25B (1998-09) F30A/ERZ/MLH/AET/ELHB/AMH/TR/AWH/ETL (2001-09) F40B/ELH/BE/ERZ/ERA/BMH/BWH (2000-09)	



	STD	
	REF	OEM
	PAF15-07020001	66M-11631-00-96
	REC66N-11603-00	66N-11603-00
	PAF15-07020006	634-11633-00
	PAF15-07020005	93450-15023
	F9.9C/CE/CMH/CWH/D (1998-08) F13.5AMH/AEH/AEP (2000-07) FT/F15A/PR/PLR/AEP/ELH/MH/AE/AM (2000-07)	



YAMAHA

RECAMBIOS MARINOS

DESPIECE MOTOR  
DE 2 TIEMPOS

ENGINE PARTS  
2 STROKES

PARTI DEL MOTORE  
2 TEMPI

PIECES MOTEUR  
2 TEMPS

2T  
STROKES 2B • 2MSH

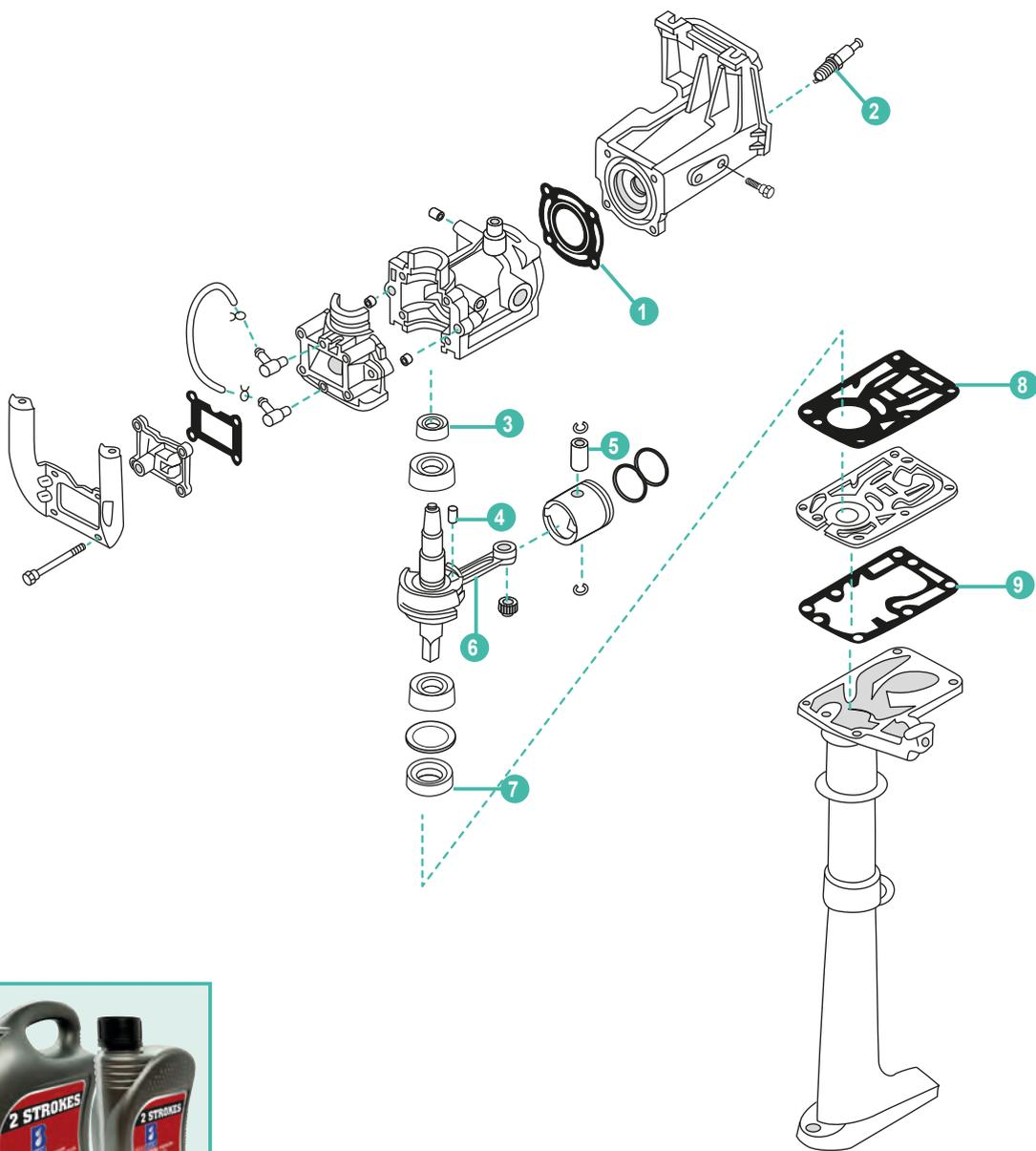

YAMAHA



	REF	OEM				UN.	
1	REC6F8-11181-A0	6F8-11181-A1	JUNTA CULATA	GASKET, CYLINDER HEAD	GUARNIZIONE TESTATA	JOINT DE CULASSE	1
2	NGKB7HS	94702-00040	BUJÍA	SPARK PLUG	CANDELA	BOUGIE	1
3	PAF2.6-04010001	93102-20070	RETÉN DE ACEITE	OIL SEAL	PARAOLIO	JOINT SPI	1
4	REC646-11681-00	646-11681-00	PIN DE BIELA	PIN, CRANK	SPINOTTO BIELLA	PIN DE BIELLE	1
5	REC646-11633-00	646-11633-00	PIN, PISTÓN	PIN, PISTON	SPINOTTO PISTONE	AXE DE PISTON	1
6	REC646-11651-02	646-11651-02	BIELA	CONNECTING ROD	BIELLA	BIELLE	1
7	REC93102-15M32	93102-15M32	RETÉN DE ACEITE	OIL SEAL	PARAOLIO	JOINT SPI	1
8	REC6A1-14613-A0	6A1-14613-A0	JUNTA TUBO DE ESCAPE	GASKET, EXHAUST PIPE	GUARNIZIONE, TUBO SCARICO	JOINT, PIPE D'ECHAPPEMENT	1
9	REC646-14623-A1	646-14623-A1	JUNTA	GASKET	GUARNIZIONE	JOINT	1

2T  
STROKES

4ACMH • 4A • 4AS • 4MSH • 4KZ • 4AC • 5C • 5CS • 5ACMH

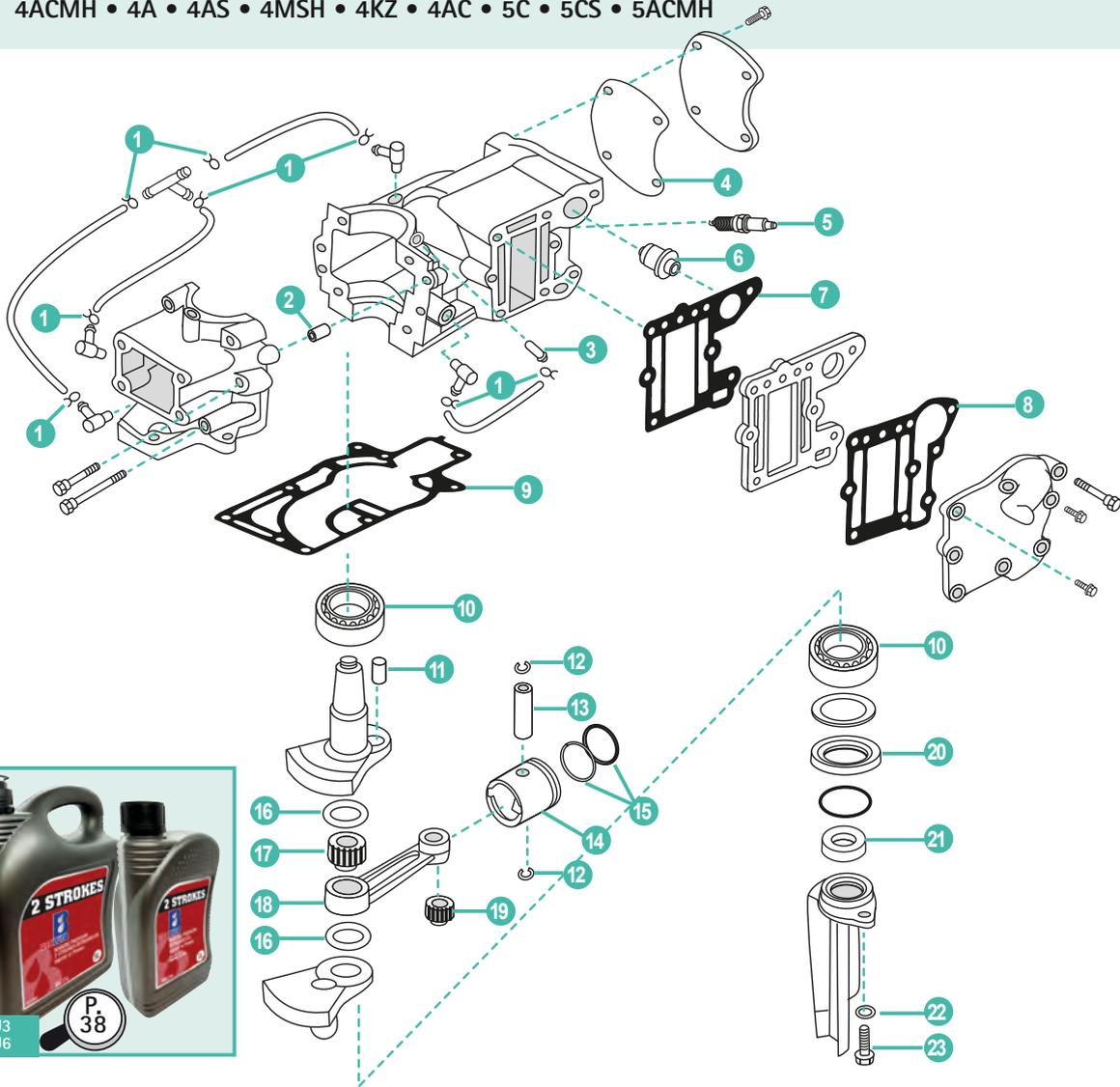

REC2TU3  
REC2TU6

REF	OEM					UN.	
1	PAHT-2.5X60	90467-06016	CLIP ABRAZADERA	CLIP	CLIP FASCETTA	COLLIER	8
2	REC93606-12019	93606-12019	PIN CENTRADOR	HOLLOW PIN	SPINOTTO DI CENTRAGGIO	PIN DE CENTRAGE	2
3	REC624-14485-00	624-14485-00	PIPA DE AGUA	PIPE, WATER	TUBO	RACCORD TUYAU D'EAU	1
4	REC6E0-11193-A1	6E0-11193-A1	JUNTA TAPA	GASKET, COVER	GAURNIZIONE COPERCHIO	JOINT COUVERCLE	1
5	NGKBR7HS	94702-00272	BUJÍA	SPARK PLUG	CANDELA	BOUGIE	1
6	REC6E5-12411-02	6E5-12411-01	TERMOSTATO	THERMOSTAT	TERMOSTATO	THERMOSTAT	1
7	REC6E0-41112-A1	6E0-41112-A1	JUNTA DE ESCAPE	EXHAUST GASKET	GUARNIZIONE DI SCARICO	JOINT D'ÉCHAPPEMENT	1
8	REC6E0-41114-A1	6E0-41114-A1	JUNTA EXTERIOR, TAPA DE ESCAPE	GASKET, EXHAUST OUTER COVER	GUARNIZIONE ESTERIORE, COPERCHIO SCARICO	JOINT DE COUVERCLE EXT ÉCHAPPEMENT	1
9	REC6E0-45113-A1	6E0-45113-A1	JUNTA BASE MOTOR	GASKET ENGINE	GUARNIZIONE BASE MOTORE	JOINT MOTEUR	1
10	REC93306-204U0	93306-204U0	RODAMIENTO	BEARING	CUSCINETTO	PALIER DE VILEBREQUIN	2
11	REC6G1-11681-00	6G1-11681-00	PIN DE CIGÜEÑAL	PIN, CRANK	SPINOTTO AALBERO MOTORE	PIN DE VILEBREQUIN	1
12	REC93450-13022	93450-13022	CIRCLIP	CIRCLIP	CIRCLIP	CIRCLIP	2
13	REC6G1-11633-00	6G1-11633-00	PIN, PISTÓN	PIN, PISTON	SPINOTTO PISTONE	AXE DE PISTON	1
14	REC6E0-11631-00-98K	6E0-11631-00-98	PISTON	PISTON STD	PISTONE	PISTON	1
15	REC6G1-11610-00	6G1-11610-00	KIT SEGMENTOS DE PISTÓN	PISTON RING KIT	KIT FASCIA PISTONE	KIT SEGMENTS	1
	REC6J1-11610-00	6J1-11610-00	KIT SEGMENTOS DE PISTÓN 5C	PISTON RING KIT 5C	KIT FASCIA PISTONE 5C	KIT SEGMENTS 5C	
16	REC90209-18112	90209-18112	ARANDELA	WASHER	RONDELLA	RONDELLE	2
17	REC93310-418V1	93310-418V1	COJINETE DE BIELA	BEARING, CONNECTING ROD	CUSCINETTO BIELLA	PALIER DE BIELLE	1
18	REC6E0-11651-01	6E0-11651-01	COJINETE DE BIELA	BEARING, CONNECTING ROD	CUSCINETTO BIELLA	PALIER DE BIELLE	1
19	REC93310-112V0	93310-112V0	RODAMIENTO	BEARING	CUSINETTO	PALIER	1
20	REC93101-20M29	93101-20M29	RETÉN DE ACEITE	OIL SEAL	PARAOLIO	JOINT SPI	1
21	REC93101-10M25	93101-10M25	RETÉN DE ACEITE	OIL SEAL	PARAOLIO	JOINT SPI	1
22	PAGB/T97.1-6	92995-06600	ARANDELA	WASHER	RONDELLA	RONDELLE	1
23	PAGB/T5783-M6X16	97095-06016	TORNILLO	BOLT	VITE	VIS	1

YAMAHA

RECAMBIOS  
MARINOS

2T  
STROKES

6CMH • 6CWH • 6MSH • 6DMH • 6MH • 6D  
8CMH • 8CWH • 8MSH • 8MH • 8D

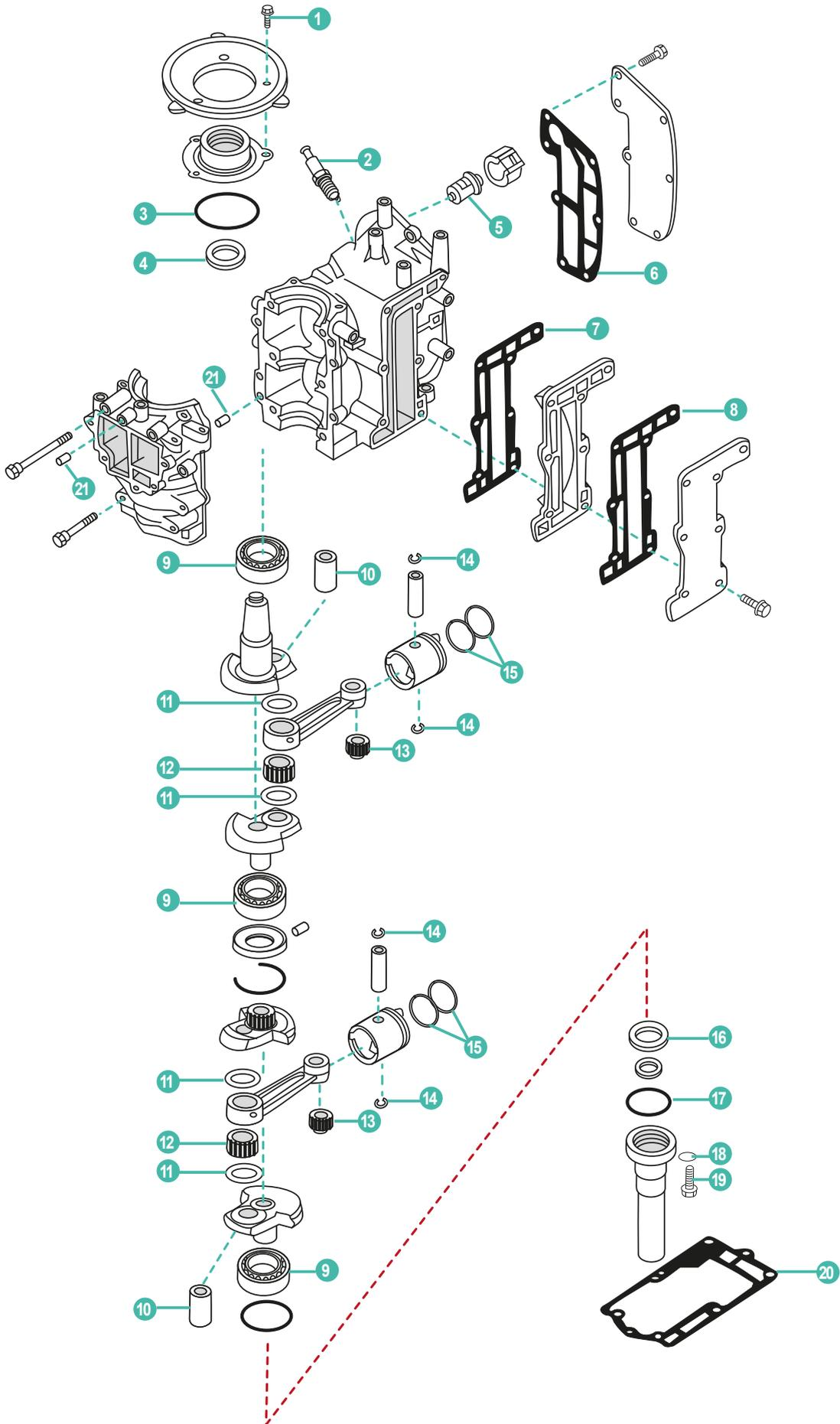

YAMAHA

RECAMBIOS  
MARINOS



	REF	OEM					UN.
1	PAGB/T5783-M5x12	97013-06016	TORNILLO	BOLT	VITE	VIS	3
2	NGKBR7HS-10	94702-00271	BUJÍA	SPARK PLUG	CANDELA	BOUGIE	2
2	NGKBR6HS-10	94702-00274	BUJÍA	SPARK PLUG	CANDELA	BOUGIE	2
3	REC93210-54M54	93210-54M54	TÓRICA	O-RING	O-RING	JOINT TORIQUE	1
4	REC93102-20M25	93102-20M25	RETÉN DE ACEITE	OIL SEAL	PARAOLIO	JOINT SPI	1
5	REC6E5-12411-02	6E5-12411-01	TERMOSTATO	THERMOSTAT	TERMOSTATO	THERMOSTAT	1
6	REC6G1-11193-A1	6G1-11193-A1	JUNTA TAPA TERMOSTATO	GASKET, THERMOSTAT COVER	GUARNIZIONE COPERCHIO TERMOSTATO	JOINT COUVERCLE DE THERMOSTAT	1
7	REC6G1-41112-A1	6G1-41112-A1	JUNTA EXTERIOR, TAPA DE ESCAPE	GASKET, EXHAUST OUTER COVER	GUARNIZIONE ESTERIORE, COPERCHIO SCARICO	JOINT DE COUVERCLE EXT ECHAPPEMENT	1
8	REC6G1-41114-A0	6G1-41114-A0	JUNTA DE ESCAPE	EXHAUST GASKET	GUARNIZIONE DI SCARICO	JOINT D'ECHAPPEMENT	1
9	REC93306-204U0	93306-204U0	RODAMIENTO	BALL BEARING	CUSCINETTO	ROULEMENT À BILLE	3
10	REC6G1-11681-00	6G1-11681-00	PIN	PIN	SPINOTTO	LEVIER D'ENTRAINEMENT	2
11	REC90209-18112	90209-18112	ARANDELA	WASHER	RONDELLA	RONDELLE	4
12	REC93310-418V1	93310-418V1	COJINETE DE BIELA	BEARING, CONNECTING ROD	CUSCINETTO BIELLA	PALIER DE BIELLE	2
13	REC93310-112V0	93310-112V0	COJINETE DE BIELA	BEARING, CONNECTING ROD	CUSCINETTO BIELLA	PALIER DE BIELLE	2
14	REC93450-13022	93450-13022	CIRCLIP	CIRCLIP	CIRCLIP	CIRCLIP	4
15	REC6G1-11610-00	6N0-E1603-00	KIT SEGMENTOS DE PISTÓN	PISTON RING SET	KIT FASCIA PISTONE	KIT SEGMENTS	2
16	REC93101-20M34	93101-20M34	RETÉN DE ACEITE	OIL SEAL	PARAOLIO	JOINT SPI	1
17	REC93210-42159	93210-42159	TÓRICA	O-RING	O-RING	JOINT TORIQUE	1
18	PAGB/T97.1-6	92995-06600	ARANDELA	WASHER	RONDELLA	RONDELLE	1
19	PAGB/T5783-M6X16	97095-06016	TORNILLO	BOLT	VITE	VIS	1
20	REC6G1-45113-A1	6G1-45113-A1	JUNTA BASE MOTOR	GASKET ENGINE	GUARNIZIONE BASE MOTORE	JOINT MOTEUR	1
21	PAF25-04000007	93604-08062	PIN CENTRADOR	HOLLOW PIN	SPINOTTO DI CENTRAGGIO	PIN DE CENTRAGE	6

REC2TU3  
REC2TU6P  
38REF OEM  
REC6G1-W0093-00 6G1-W0093-00P  
95

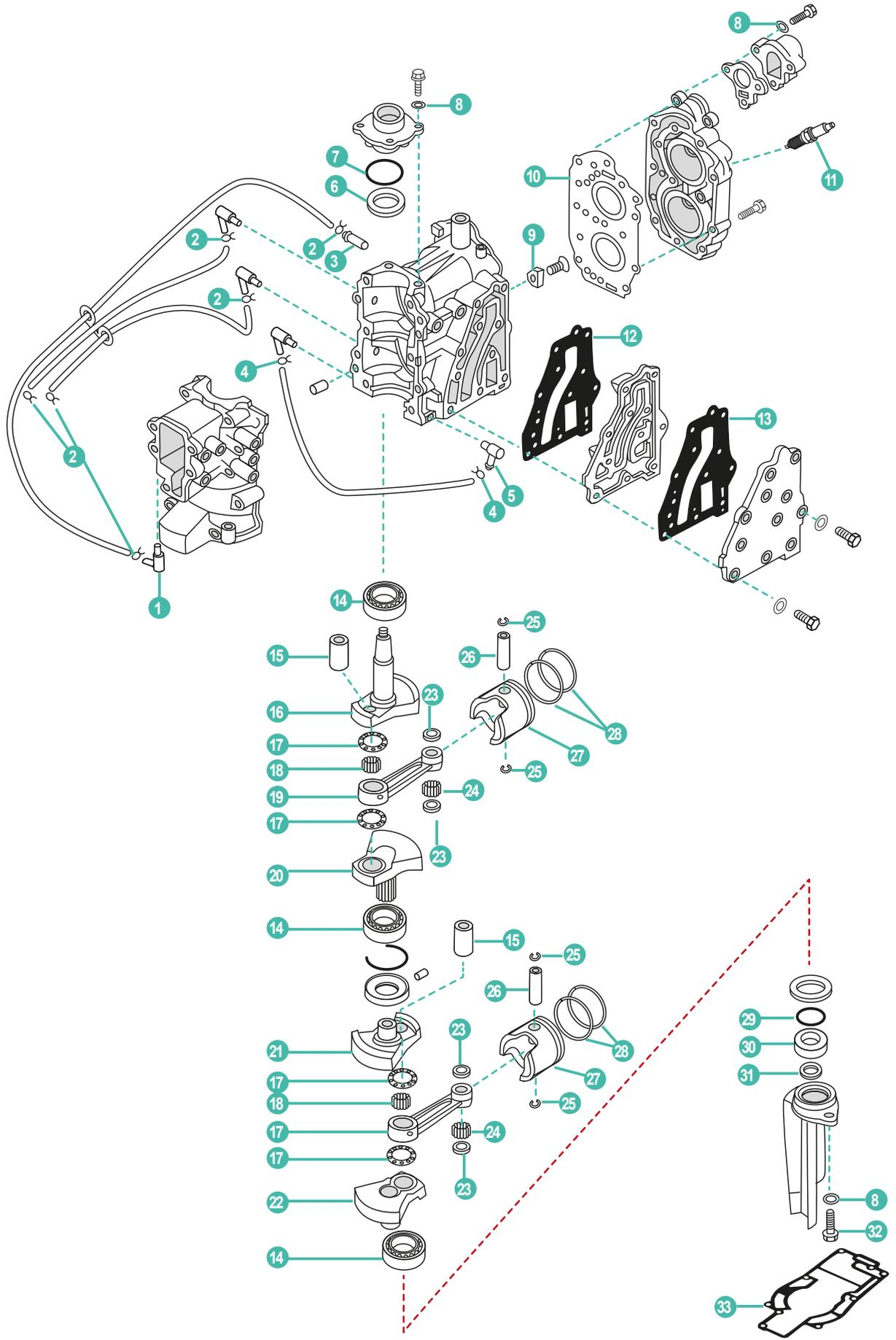

	REF	OEM				UN.	
1	REC650-11370-00	650-11370-01	NIPLE DE MANGUERA	NIPPLE	TUBO	RACCORD D'EAU	1
2	PAHT-2.5X60	90467-06016	PRESILLA	CLIP	CLIP	CLIP	6
3	REC624-14485-00	624-14485-00	PIPA DE AGUA	PIPE, WATER	TUBO	RACCORD TUYAU D'EAU	1
4	PAF4-04000030	90467-09M09	PRESILLA	CLIP	CLIP	CLIP	2
5	PAF15-04000005	676-11372-00	NIPLE DE MANGUERA	NIPPLE	TUBO	RACCORD D'EAU	1
6	REC93102-20M25	93102-20M25	RETÉN DE ACEITE	OIL SEAL	PARAOLIO	JOINT SPI	1
7	REC93210-42159	93210-42159	TÓRICA	O-RING	O-RING	JOINT TORIQUE	1
8	PAGB/T97.1-6	92995-06600	ARANDELA	WASHER	RONDELLA	RONDELLE	6
9	TEN01166	664-11325-00	ÁNODO	ANODE	ANODO	ANODE	1
10	REC677-11181-A0	677-11181-A1	JUNTA CULATA	GASKET, CYLINDER HEAD	GUARNIZIONE TESTATA	JOINT DE CULASSE	1
11	NGKB7HS-10	94702-00217	BUJÍA	SPARK PLUG	CANDELA	BOUGIE	2
12	REC677-41112-A0	677-41112-A1	JUNTA DE ESCAPE	EXHAUST GASKET	GUARNIZIONE DI SCARICO	JOINT D'ÉCHAPPEMENT	1
13	REC677-41112-A0	677-41114-A1	JUNTA EXTERIOR, TAPA DE ESCAPE	GASKET, EXHAUST OUTER COVER	GUARNIZIONE ESTERIORE, COPERCHIO SCARICO	JOINT DE COUVERCLE EXT ÉCHAPPEMENT	1
14	REC93306-204U0	93306-240U0	RODAMIENTO	BALL BEARING	CUSCINETTO	ROULEMENT À BILLE	3
15	REC6G1-11681-00	6G1-11681-00	PIN	PIN	SPINOTTO	LEVIER D'ENTRAÎNEMENT	2
16	REC677-11412-02	677-11412-02	CIGÜEÑAL 1	CRANK 1	ALBERO MOTORE 1	VILEBREQUIN 1	1
17	REC90209-18112	90209-18112	ARANDELA	WASHER	RONDELLA	RONDELLE	4
18	REC93310-418U0	93310-418U0	COJINETE DE BIELA	BEARING, CONNECTING ROD	CUSCINETTO BIELLA	PALIER DE BIELLE	2
19	REC6E0-11651-01	6E0-11651-01	BIELA	CONNECTING ROD	BIELLA	BIELLE	2
20	REC677-11422-02	677-11422-02	CIGÜEÑAL 2	CRANK 2	ALBERO MOTORE 2	VILEBREQUIN 2	1
21	REC677-11432-02	677-11432-02	CIGÜEÑAL 3	CRANK 3	ALBERO MOTORE 3	VILEBREQUIN 3	1
22	REC677-11442-02	677-11442-02	CIGÜEÑAL 4	CRANK 4	ALBERO MOTORE 4	VILEBREQUIN 4	1
23	REC90201-12565	90201-12565	ARANDELA PLANA	WASHER PLATE	RONDELLA PIANA	RONDELLE	4
24	REC93602-14118	93602-14118	COJINETE DE BIELA	BEARING, CONNECTING ROD	CUSCINETTO BIELLA	PALIER DE BIELLE	56
25	REC93450-13022	93450-13022	CIRCLIP	CIRCLIP	CIRCLIP	CIRCLIP	4
26	REC6G1-11633-00	6G1-11633-00	PIN, PISTÓN	PIN, PISTON	SPINOTTO PISTONE	AXE DE PISTON	2
	REC677-11631-00K	677-11631-00-97	PISTÓN STD	PISTON STD	PISTONE STD	PISTON STD	
27	REC677-11635-00K	677-11635-00	PISTÓN 0.25mm O/S	PISTON 0.25mm O/S	PISTONE 0.25mm O/S	PISTON 0.25mm O/S	2
	REC677-11636-00K	677-11636-00	PISTÓN 0.50mm O/S	PISTON 0.50mm O/S	PISTONE 0.50mm O/S	PISTON 0.50mm O/S	
	REC647-11610-00	647-11610-00	KIT SEGMENTOS STD	PISTON RING SET STD	KIT FASCE STD	KIT SEGMENTS STD	
28	REC647-11610-10	647-11610-10	KIT SEGMENTOS 0.25mm O/S	PISTON RING SET 0.25mm O/S	KIT FASCE 0.25mm O/S	KIT SEGMENTS 0.25mm O/S	2
	REC647-11610-20	647-11610-20	KIT SEGMENTOS 0.50mm O/S	PISTON RING SET 0.50mm O/S	KIT FASCE 0.50mm O/S	KIT SEGMENTS 0.50mm O/S	
29	REC93210-42M70	93210-42M70	TÓRICA	O-RING	O-RING	JOINT TORIQUE	1
30	REC93101-20M29	93101-20M29	RETÉN DE ACEITE	OIL SEAL	PARAOLIO	JOINT SPI	1
31	REC93101-14M01	93101-14M01	RETÉN DE ACEITE	OIL SEAL	PARAOLIO	JOINT SPI	1
32	PAGB/T5783-M6X16	97095-06016	PERNO	STUD	BULLONE	BOULON	2
33	REC677-45113-A0	677-45113-A0	JUNTA BASE MOTOR	GASKET ENGINE	GUARNIZIONE BASE MOTORE	JOINT MOTEUR	1



REC2TU3  
REC2TU6



REF OEM  
REC677-W0093-00 677-W0093-00

2T  
STROKES

9.9F/FM/FEM/MHV • 9.9FMH/MSH • 13.5AMH • 15F/FEM/FM/MH/MSH • 15FW/MHH



REC2TU3  
REC2TU6

P  
38

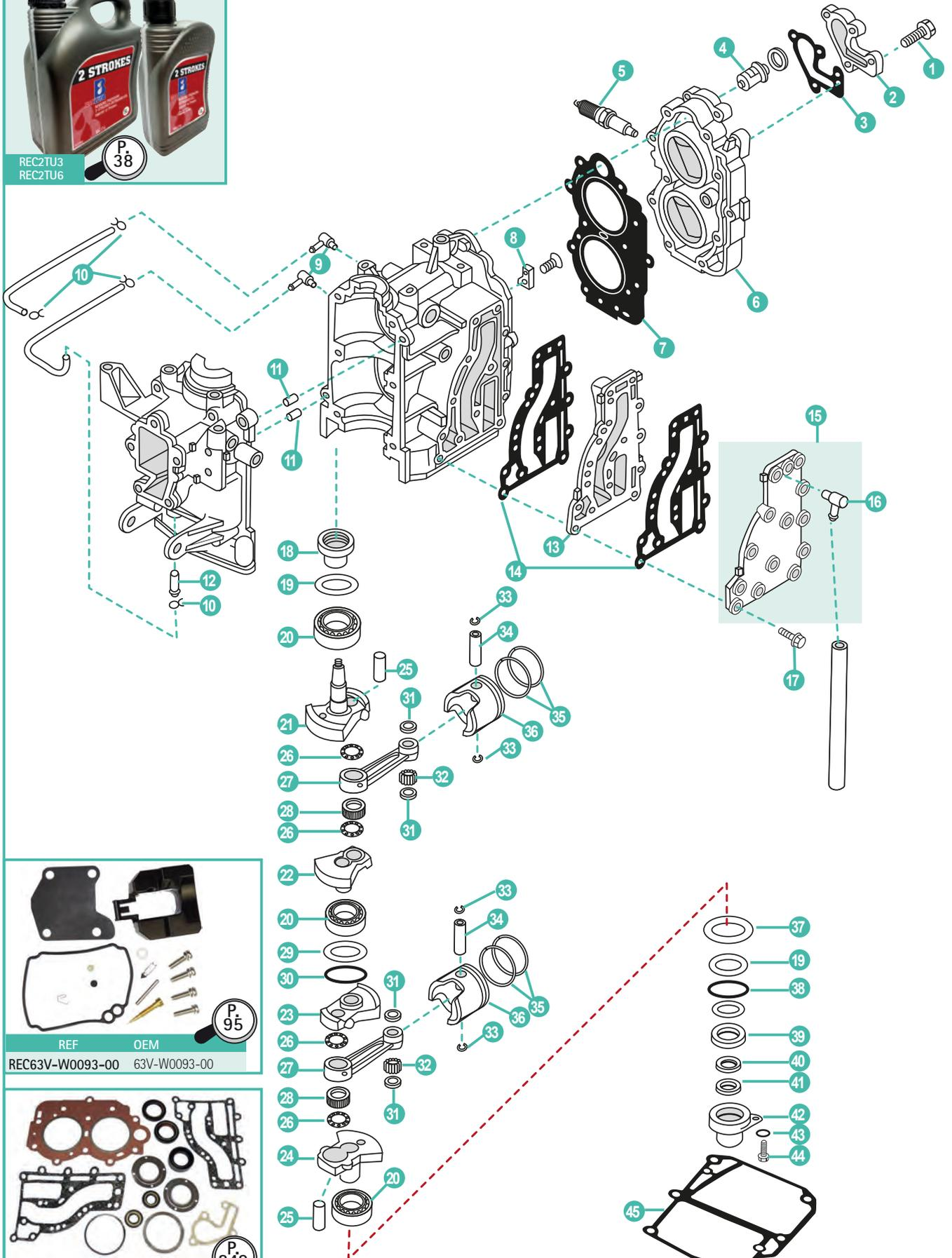

REF OEM  
REC63V-W0093-00 63V-W0093-00

P  
95



REF OEM  
REC63V-W0001-00 63V-W0001-00

P  
249

YAMAHA

RECAMBIOS  
MARINOS

	REF	OEM				UN.	
1	PAGB/T5783-M6X20	90119-06MA2	TORNILLO	BOLT	VITE	VIS	4
2	REC682-12413-00-1S	682-12413-00-1S	TAPA TERMOSTATO	COVER, THERMOSTAT	COPERCHIO TERMOSTATO	COUVERCLE DE THERMOSTAT	1
3	REC682-12414-A1	682-12414-A1	JUNTA TAPA TERMOSTATO	GASKET, THERMOSTAT COVER	GUARNIZIONE COPERCHIO TERMOSTATO	JOINT COUVERCLE DE THERMOSTAT	1
4	REC6E5-12411-30	6E5-12411-30	TERMOSTATO	THERMOSTAT	TERMOSTATO	THERMOSTAT	1
5	NGKB7HS-10	94702-00271	BUJÍA	SPARK PLUG	CANDELA	BOUGIE	2
6	REC6E7-11111-01-1S	6E7-11111-01-1S	CULATA	HEAD CYLINDER	TESTATA	CULASSE	1
7	REC63V-11181-A1	63V-11181-A2	JUNTA CULATA	GASKET, CYLINDER HEAD	GUARNIZIONE TESTATA	JOINT DE CULASSE	1
8	TEN01162	682-11325-00	ÁNODO DE ZINC	ZINC ANODE	ANODO ZINCO	ANODE ZINC	1
9	REC650-14485-03	650-14485-03	NIPLE DE MANGUERA	NIPPLE	TUBO	RACCORD D'EAU	2
10	PAHT-2.5X60	90467-06016	BRIDA	CLAMP	FLANGIA	COLLIER	4
11	REC93606-12019	93606-12019	PIN CENTRADOR	HOLLOW PIN	SPINOTTO DI CENTRAGGIO	PIN DE CENTRAGE	2
12	REC624-14485-00	624-14485-00	PIPA DE AGUA	PIPE, WATER	TUBO	RACCORD TUYAU D'EAU	1
13	REC63V-41111-00-1S	63V-41111-00-1S	PLACA ESCAPE	INNER COVER, EXHAUST	PIASTRA SCARICO	PLAQUE D'ECHAPPEMENT	1
14	REC63V-41112-A0	63V-41112-A0	JUNTA TAPA	GASKET, COVER	GAURNIZIONE COPERCHIO	JOINT COUVERCLE	2
15	REC63V-41113-00-1S	63V-41113-00-1S	CUBIERTA DE ESCAPE	EXHAUST COVER	COPERCHIO SCARICO	COUVERCLE D'ECHAPPEMENT	1
16	PAF15-04000005	676-11372-00	NIPLE DE MANGUERA	NIPPLE	TUBO	RACCORD D'EAU	1
17	PAGB/T5783-M6X30	90119-06M04	TORNILLO	BOLT	VITE	VIS	13
18	REC93110-23M00	93110-23M00	RETÉN DE ACEITE	OIL SEAL	PARAOLIO	JOINT SPI	1
19	REC63V-11445-00	63V-11445-00	ESPACIADOR	COLLAR	DISTANZIALE	ENTRETOISE	2
20	REC93306-205U7	93306-205U7	RODAMIENTO	BALL BEARING	CUSCINETTO	ROULEMENT À BILLE	3
21	REC63V-11412-00	63V-11412-00	CIGÜEÑAL 1	CRANK 1	ALBERO MOTORE 1	VILEBREQUIN 1	1
22	REC63V-11422-00	63V-11422-00	CIGÜEÑAL 2	CRANK 2	ALBERO MOTORE 2	VILEBREQUIN 2	1
23	REC63V-11432-00	63V-11432-00	CIGÜEÑAL 3	CRANK 3	ALBERO MOTORE 3	VILEBREQUIN 3	1
24	REC63V-11442-00	63V-11442-00	CIGÜEÑAL 4	CRANK 4	ALBERO MOTORE 4	VILEBREQUIN 4	1
25	REC682-11681-00	682-11681-00	PIN	PIN	SPINOTTO	PIN	2
26	REC90209-20159	90209-20M23	ARANDELA	WASHER	RONDELLA	RONDELLE	4
27	REC650-11651-04	650-11651-00	BIELA	CONNECTING ROD	BIELLA	BIELLE	2
28	REC93310-620V5	93310-620V5	COJINETE DE BIELA	BEARING, CONNECTING ROD	CUSCINETTO BIELLA	PALIER DE BIELLE	2
29	REC63V-11515-02	63V-11515-02	ARILLO	SEAL LABYRINTH	GUARNIZIONE	JOINT	1
30	REC93440-52009	93440-52008	CLIP	CLIP	CLIP	CLIP	1
31	REC90201-14377	9020-14377	ARANDELA	WASHER	RONDELLA	RONDELLE	4
32	REC93602-14104	93602-14104	AGUJAS DE RODAMIENTO	PIN DOWEL	SPILLO CUSCINETTO	AIGUILLE DE PALIER	50
33	REC93450-15023	93450-15023	CIRCLIP	CIRCLIP	CIRCLIP	CIRCLIP	4
34	REC634-11633-00	634-11633-00	PIN, PISTÓN	PIN, PISTON	SPINOTTO PISTONE	AXE DE PISTON	2
	REC682-11610-01	682-11610-01	KIT SEGMENTOS STD	PISTON RING SET STD	KIT FASCE STD	KIT SEGMENTS STD	
35	REC682-11610-11	682-11610-11	KIT SEGMENTOS 0.25mm O/S	PISTON RING SET 0.25mm O/S	KIT FASCE 0.25mm O/S	KIT SEGMENTS 0.25mm O/S	2
	REC682-11610-21	682-11610-21	KIT SEGMENTOS 0.50mm O/S	PISTON RING SET 0.50mm O/S	KIT FASCE 0.50mm O/S	KIT SEGMENTS 0.50mm O/S	
	REC6E7-11631-00K	6E7-11631-00-97	PISTÓN STD	PISTON STD	PISTONE STD	PISTON STD	
36	REC6E7-11635-00K	6E7-11635-00	PISTÓN 0.25mm O/S	PISTON 0.25mm O/S	PISTONE 0.25mm O/S	PISTON 0.25mm O/S	2
	REC6E7-11636-00K	6E7-11636-00	PISTÓN 0.50mm O/S	PISTON 0.50mm O/S	PISTONE 0.50mm O/S	PISTON 0.50mm O/S	
37	REC90201-46M29	90201-46M29	ARANDELA	WASHER	RONDELLA	RONDELLE	1
38	REC93210-46M16	93210-46M16	TÓRICA	O-RING	O-RING	JOINT TORIQUE	1
39	REC93102-25M48	93102-25M48	RETÉN DE ACEITE	OIL SEAL	PARAOLIO	JOINT D'HUILE	1
40	REC93101-25018	93101-250-18	RETÉN DE ACEITE	OIL SEAL	PARAOLIO	JOINT D'HUILE	1
41	REC93101-13018	93101-13018	RETÉN DE ACEITE	OIL SEAL	PARAOLIO	JOINT D'HUILE	2
42	REC63V-15396-01-CA	63V-15396-01-CA	CUERPO DEL RETÉN	SHELL, OIL SEAL	GUARNIZIONE CORPO	LOGEMENT JOINT SPI	1
43	PAGB/T97.1-8	92995-06600	ARANDELA	WASHER	RONDELLA	RONDELLE	1
44	PAGB/T5783-M6X16	97095-06016	TORNILLO	BOLT	VITE	VIS	1
45	REC63V-45113-A1	63V-45113-A1	JUNTA BASE MOTOR	GASKET ENGINE	GUARNIZIONE BASE MOTORE	JOINT DE TETE MOTRICE	1

2T  
STROKES

25B/BMH/BWH/VE/B07 • E25BMH/HMH • 30G/HMH/W/HWL/HWC • E30HMH

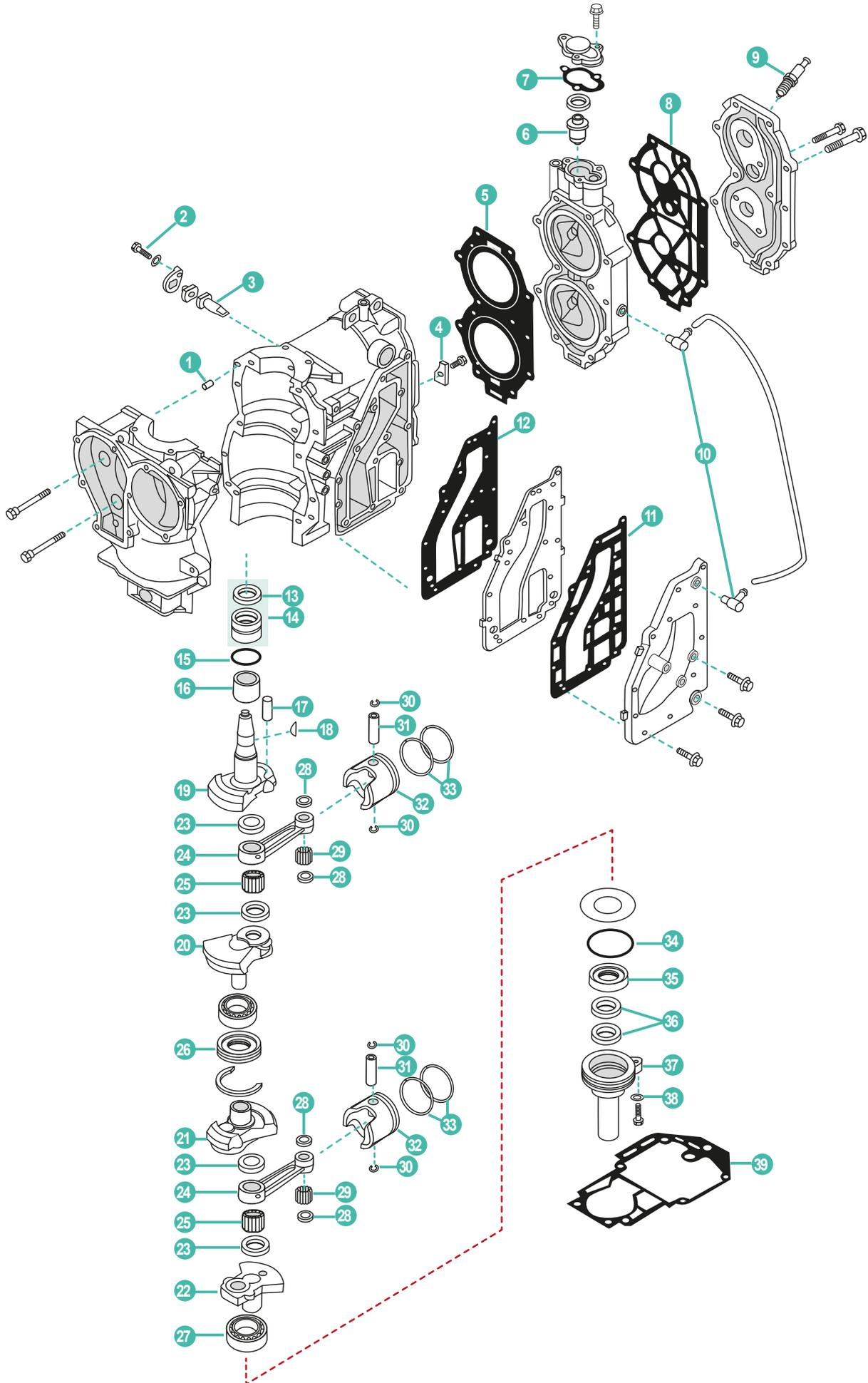

YAMAHA

RECAMBIOS  
MARINOS

	REF	OEM					UN.
1	REC93606-12019	93606-12019	PIN CENTRADOR	HOLLOW PIN	SPINOTTO DI CENTRAGGIO	PIN DE CENTRAGE	2
2	PAGB/T5783-M5X12	97013-06016	TORNILLO	BOLT	VITE	VIS	1
3	TEN01150	6J8-11325-00	ÁNODO DE ZINC	ZINC ANODE	ANODO DI ZINCO	ANODE ZINC	1
4	TEN01121	689-11325-00	ÁNODO DE ZINC	ZINC ANODE	ANODO DI ZINCO	ANODE ZINC	1
5	REC61N-11181-00	61N-11181-A1	JUNTA CULATA	GASKET, CYLINDER HEAD	GUARNIZIONE TESTATA	JOINT DE CULASSE	1
6	REC6E5-12411-02	6E5-12411-01	TERMOSTATO	THERMOSTAT	TERMOSTATO	THERMOSTAT	1
7	REC655-12414-A1	655-12414-A1	JUNTA TAPA TERMOSTATO	GASKET, THERMOSTAT COVER	GUARNIZIONE COPERCHIO TERMOSTATO	JOINT COUVERCLE DE THERMOSTAT	1
8	REC61T-11193-A0	61T-11193-A1	JUNTA TAPA DE CULATA	GASKET, CYLINDER HEAD COVER	GUARNIZIONE COPERCHIO TESTATA	JOINT COUVERCLE DE CULASSE	1
9	NGKBR7HS-10	94702-00271	BUJÍA	SPARK PLUG	CANDELA	BOUGIE	2
	NGKB7HS-10	94702-00217	BUJÍA	SPARK PLUG	CANDELA	BOUGIE	2
10	PAF15-04000005	676-11372-00	NIPLE DE MANGUERA	NIPPLE	TUBO	RACCORD D'EAU	2
11	REC6K8-41124-A1	6K8-41124-A1	JUNTA EXTERIOR, TAPA DE ESCAPE	GASKET, EXHAUST OUTER COVER	GUARNIZIONE ESTERIORE, COPERCHIO SCARICO	JOINT DE COUVERCLE EXT ECHAPPEMENT	1
12	REC6K8-41122-A1	6K8-41122-A1	JUNTA DE ESCAPE	EXHAUST GASKET	GUARNIZIONE DI SCARICO	JOINT D'ECHAPPEMENT	1
13	REC93102-32M07	93102-32M07	RETÉN DE ACEITE	OIL SEAL	PARAOILIO	JOINT SPI	1
14	REC93399-99951	93399-99951	RODAMIENTO	BEARING	CUSCINETTO	ROULEMENT À BILLE	1
15	REC93210-46M16	93210-46M16	TÓRICA	O-RING	O-RING	JOINT TORIQUE	1
16	REC90387-32002	90387-32002	COLLAR	COLLAR	COLLARE	COLLIER	1
17	REC689-11681-00	689-11681-01	PIN	PIN	SPINOTTO	PIN	2
18	REC90280-05049	90280-05049	CHAVETA	KEY WOODRUFF	CHIAVETTA	CLAVETTE	1
19	REC6G0-11412-00	69P-11412-00	CIGÜEÑAL 1	CRANK 1	ALBERO MOTORE 1	VILEBREQUIN 1	1
20	REC6G0-11422-00	69P-11422-00	CIGÜEÑAL 2	CRANK 2	ALBERO MOTORE 2	VILEBREQUIN 2	1
21	REC6G0-11432-00	69P-11432-00	CIGÜEÑAL 3	CRANK 3	ALBERO MOTORE 3	VILEBREQUIN 3	1
22	REC6G0-11442-00	69P-11442-00	CIGÜEÑAL 4	CRANK 4	ALBERO MOTORE 4	VILEBREQUIN 4	1
23	REC90209-24M03	90209-24M03	ARANDELA	WASHER	RONDELLA	RONDELLE	4
24	REC689-11651-00	689-11651-00	BIELA	ROD CONNECTING	BIELLA	BIELLE	2
25	REC93310-624U5	93310-62406	COJINETE DE BIELA	BEARING, CONNECTING ROD	CUSCINETTO BIELLA	PALIER DE BIELLE	2
26	REC61N-11515-00	61N-11515-00	ARO	SEAL, LABYRINTH	O-RING	JOINT	1
27	REC93306-305U3	93306-305U3	RODAMIENTO	BEARING	CUSCINETTO	PALIER	1
28	REC90201-20M27	90201-20M27	ARANDELA PLANA	WASHER, PLATE	RONDELLA PIANA	RONDELLE	4
29	REC93602-20M02	93602-20M02	AGUJA PASADOR	NEEDLE PIN	SPILLO	AIGUILLE	68
	REC93602-18M12	93602-18M12	AGUJAS PASADOR 25N/M & 20D/M	NEEDLE PIN 25N/M & 20D/M	SPILLO 25N/M & 20D/M	AIGUILLE 25N/M & 20D/M	
30	REC688-11634-00	688-11634-00	CIRCLIP	CIRCLIP	CIRCLIP	CIRCLIP	4
31	REC689-11633-00	689-11633-00	PIN, PISTÓN	PIN, PISTON	SPINOTTO PISTONE	AXE DE PISTON	2
	REC61N-11631-00K	61N-11631-00-95	PISTÓN STD	PISTON STD	PISTONE STD	PISTON STD	2
32	REC61N-11635-00K	61N-11635-00	PISTÓN 0.25mm O/S	PISTON 0.25mm O/S	PISTONE 0.25mm O/S	PISTON 0.25mm O/S	2
	REC61N-11636-00K	61N-11636-00	PISTÓN 0.50mm O/S	PISTON 0.50mm O/S	PISTONE 0.50mm O/S	PISTON 0.50mm O/S	2
	REC61N-11603-00	61N-11603-00	KIT SEGMENTOS STD	PISTON RING SET STD	KIT FASCE STD	KIT SEGMENTS STD	2
33	REC61N-11604-00	61N-11604-00	KIT SEGMENTOS 0.25mm O/S	PISTON RING SET 0.25mm O/S	KIT FASCE 0.25mm O/S	KIT SEGMENTS 0.25mm O/S	
	REC61N-11605-00	61N-11605-00	KIT SEGMENTOS 0.50mm O/S	PISTON RING SET 0.50mm O/S	KIT FASCE 0.50mm O/S	KIT SEGMENTS 0.50mm O/S	
34	REC93210-58M21	93210-58M21	TÓRICA	O-RING	O-RING	JOINT TORIQUE	1
35	REC93102-25008	93102-25008	RETÉN DE ACEITE	OIL SEAL	PARAOILIO	JOINT SPI	1
36	REC93101-16001	93101-16001	RETÉN DE ACEITE	OIL SEAL	PARAOILIO	JOINT SPI	2
37	REC689-15396-01-CA	689-15396-01-5B	CUERPO DEL RETÉN	SHELL, OIL SEAL	GUARNIZIONE CORPO	LOGEMENT JOINT SPI	1
38	PAGB/T97.1-8	92995-06600	ARANDELA	WASHER	RONDELLA	RONDELLE	1
39	REC61T-45113-A0	689-45113-A1	JUNTA BASE MOTOR	GASKET ENGINE	GUARNIZIONE BASE MOTORE	JOINT DE TETE MOTRICE	1

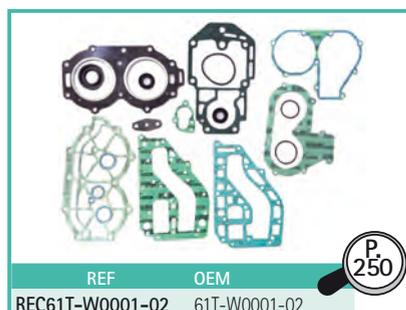

2T  
STROKES

25HP J/JEO/ESH • 30HP D/DEO/DETO • 30ELH/ELA • 30DMHO/DMSH • 30ERZ/DEL • 30MLH (1986-13)

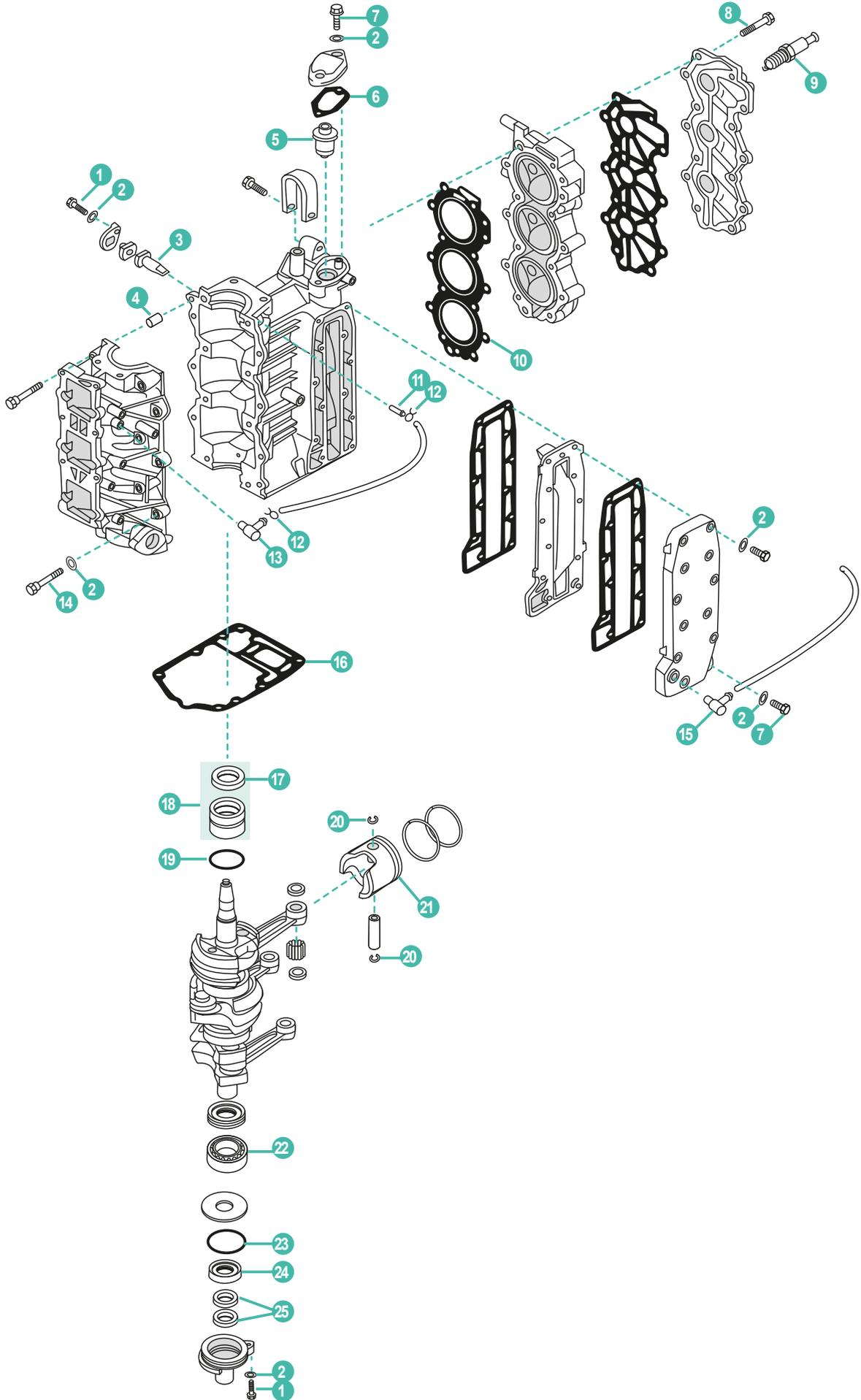

YAMAHA

RECAMBIOS  
MARINOS



	REF	OEM					UN.
1	PAGB/T5783-M6X16	97095-06016	TORNILLO	BOLT	VITE	VIS	4
2	PAGB/T97.1-6	92990-06600	ARANDELA PLANA	FLAT WASHER	RONDELLA PIANA	RONDELLE PLANE	24
3	TEN01150	6J8-11325-00	ÁNODO	ANODE	ANODO	ANODE	2
4	REC93606-12019	93606-12019	PIN CENTRADOR	HOLLOW PIN	SPINOTTO DI CENTRAGGIO	PIN DE CENTRAGE	2
5	REC6E5-12411-02	6E5-12411-01	TERMOSTATO	THERMOSTAT	TERMOSTATO	THERMOSTAT	1
6	REC61A-12414-A0	61A-12414-A0	JUNTA TAPA TERMOSTATO	GASKET, THERMOSTAT COVER	GUARNIZIONE COPERCHIO TERMOSTATO	JOINT COUVERCLE DE THERMOSTAT	1
7	PAGB/T5782-M6X25	97095-06025	TORNILLO	BOLT	VITE	VIS	3
8	REC90119-08M21	90119-08M21	TORNILLO CON ARANDELA	BOLT, FLANGE	VITE CON RONDELLA	VIS DE BRIDE	14
9	NGKBR7HS-10	94702-00271	BUJÍA	SPARK PLUG	CANDELA	BOUGIE	3
10	REC6J8-11181-A2	6J8-11181-A1	JUNTA CULATA	GASKET, CYLINDER HEAD	GUARNIZIONE TESTATA	JOINT DE CULASSE	1
11	REC624-14485-00	624-14485-00	PIPA DE AGUA	PIPE, WATER	TUBO	RACCORD TUYAU D'EAU	1
12	PAHT-2.5X60	90467-06016	PRESILLA	CLAMP	CLIP	COLLIER	2
13	REC650-11370-00	650-11370-00	NIPLA DE MANGUERA	NIPPLE	TUBO	RACCORD D'EAU	1
14	PAGB/T5783-M6X30	970-95-06030	TORNILLO	BOLT	VITE	VIS	6
15	PAF15-04000005	676-11372-00	NIPLA DE MANGUERA	NIPPLE	TUBO	RACCORD D'EAU	1
16	REC6J8-45113-00	6J8-45113-A0	JUNTA BASE MOTOR	GASKET ENGINE	GUARNIZIONE BASE MOTORE	JOINT DE TETE MOTRICE	1
17	REC93102-26M27	93102-26M27	RETÉN DE ACEITE	OIL SEAL	PARAOLIO	JOINT SPI	1
18	REC93311-632U7	93311-632U7	COJINETE DE RODILLOS	BEARING CYL	CUSCINETTO CILINDRO	ROULEMENT	1
19	REC93210-42159	93210-42159	TÓRICA	O-RING	O-RING	JOINT TORIQUE	1
20	PAF25-05020106	93450-17129	CIRCLIP	CIRCLIP	CIRCLIP	CIRCLIP	6
21	REC6J8-11631-02	6J8-11631-02-97	PISTÓN STD	PISTO STD	PISTONE STD	PISTON STD	3
22	REC93306-305U3	93306-305U3	RODAMIENTO	BALL BEARING	CUSCINETTO	ROULEMENT À BILLE	1
23	PAF15-06080003	93210-56M80	TÓRICA	O-RING	O-RING	JOINT TORIQUE	1
24	REC93101-25M35	93101-25M28	RETÉN DE ACEITE	OIL SEAL	PARAOLIO	JOINT SPI	1
25	REC93104-16M01	93104-16M04	RETÉN DE ACEITE	OIL SEAL	PARAOLIO	JOINT SPI	2



2T  
STROKES

E40X • 40XMH • E40XMH/XW/XWT

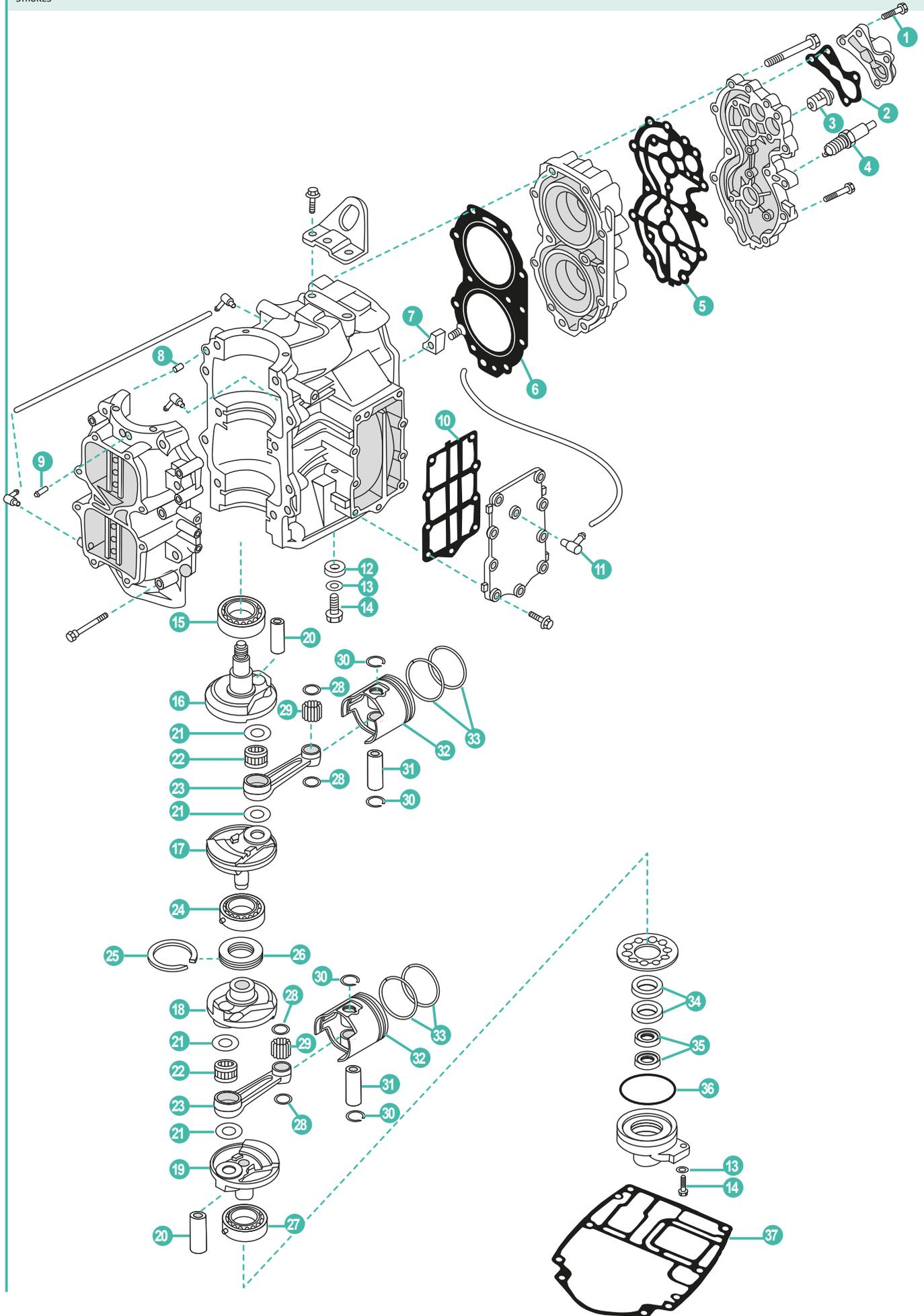

YAMAHA

RECAMBIOS  
MARINOS

	REF	OEM				UN.	
1	PAGB/T5782-M6X35	90119-06MA5	TORNILLO	BOLT WITH WASHER	VITE	VIS	4
2	REC676-12414-A0	676-12414-A0	JUNTA TAPA TERMOSTATO	GASKET, THERMOSTAT COVER	GUARNIZIONE COPERCHIO TERMOSTATO	JOINT COUVERCLE DE THERMOSTAT	1
3	REC6E5-12411-02	6E5-12411-01	TERMOSTATO	THERMOSTAT	TERMOSTATO	THERMOSTAT	1
4	NGKBR7HS	B7H-S0000-00-00	BUJÍA	SPARK PLUG	CANDELA	BOUGIE	2
5	REC66T-11193-A0	66T-11193-A0	JUNTA DE CULATÍN	HEAD VOER GASKET	GUARNIZIONE TESTATA	JOIN DE COUVRE CULASSE	1
6	REC66T-11181-00	66T-11181-A2	JUNTA CULATA	GASKET, CYLINDER HEAD	GUARNIZIONE TESTATA	JOINT DE CULASSE	1
7	TEN01166	676-11325-00	ÁNODO	ANODE	ANODO	ANODE	1
8	PAF15-00000014	93608-12063	PIN CENTRADOR	HOLLOW PIN	SPINOTTO DI CENTRAGGIO	PIN DE CENTRAGE	2
9	REC624-14485-00	624-14485-00	PIPA DE AGUA	PIPE, WATER	TUBO	RACCORD TUYAU D'EAU	1
10	REC66T-41114-A0	66T-41114-A0	JUNTA TAPA	GASKET, COVER	GUARNIZIONE COPERCHIO	JOINT COUVERCLE	1
11	PAF15-04000005	676-11372-00	NIPLE DE MANGUERA	NIPPLE	TUBO	RACCORD D'EAU	1
12	TEN01127	676-45251-00	ÁNODO	ANODE	ANODO	ANODE	1
13	PAGB/T97.1-8	92995-06600	ARANDELA	WASHER	RONDELLA	RONDELLE	2
14	PAGB/T5783-M6X20	97095-06020	TORNILLO	BOLT	VITE	VIS	2
15	REC93306-307U0	93306-307U0	RODAMIENTO	BEARING	CUSCINETTO	ROULEMENT À BILLE	1
16	REC66T-11412-00	66T-11412-00	CIGÜEÑAL 1	CRANK 1	ALBERO MOTORE 1	VILEBREQUIN 1	1
17	REC66T-11422-00	66T-11422-00	CIGÜEÑAL 2	CRANK 2	ALBERO MOTORE 2	VILEBREQUIN 2	1
18	REC66T-11432-00	66T-11432-00	CIGÜEÑAL 3	CRANK 3	ALBERO MOTORE 3	VILEBREQUIN 3	1
19	REC66T-11442-00	66T-11442-00	CIGÜEÑAL 4	CRANK 4	ALBERO MOTORE 4	VILEBREQUIN 4	1
20	REC66T-11681-00	66T-11681-00	PIN	PIN	SPINOTTO	PIN D'ENTRAÎNEMENT	2
21	REC90209-27M07	90209-27M07	ARANDELA	WASHER	RONDELLA	RONDELLE	4
22	REC93310-727U0	93310-727U0	RODAMIENTO	BEARING	CUSCINETTO	ROULEMENT	2
23	REC6F5-11651-00	6F5-11651-00	BIELA	ROD CONNECTING	BIELLA	BIELLE	2
24	REC93332-000UE	93332-000UE	RODAMIENTO	BEARING	CUSCINETTO	ROULEMENT À BILLE	1
25	REC93440-68M03	93440-68M03	CIRCLIP	CIRCLIP	CIRCLIP	CIRCLIP	1
26	REC6F5-11515-00	6F5-11515-00	ARILLO	SEAL, LABERYNTH	GUARNIZIONE TONDA	JOINT	1
27	REC93306-306V5	9306-306V5	RODAMIENTO	BEARING	CUSCINETTO	ROULEMENT	1
28	REC90201-20417	90201-20417	ARANDELA	WASHER PLATE	RONDELLA	RONDELLE	4
29	REC93603-21111	93603-21111	AGUJAS DE RODAMIENTO	PIN, DOWEL	SPINOTTO CENTRAGGIO	AIGUILLE	56
30	REC663-11634-00	633-11634-00	JUNTA	CLIP	GUARNIZIONE	JOINT	4
31	REC6F5-11633-00	6F5-11633-00	PIN, PISTÓN	PIN, PISTON	SPINOTTO PISTONE	AXE DE PISTON	2
	REC66T-11631-01K	66T-11631-01-93	PISTÓN STD	PISTON STD	PISTONE STD	PISTON STD	
32	REC66T-11635-01K	66T-11635-01	PISTÓN 0.25mm O/S	PISTON 0.25mm O/S	PISTONE 0.25mm O/S	PISTON 0.25mm O/S	2
	REC66T-11636-01K	66T-11636-01	PISTÓN 0.50mm O/S	PISTON 0.50mm O/S	PISTONE 0.50mm O/S	PISTON 0.50mm O/S	
	REC66T-11603-00	66T-11603-00	KIT SEGMENTOS STD	PISTON RING SET STD	KIT FASCE STD	KIT SEGMENTS STD	
33	REC66T-11604-00	66T-11604-00	KIT SEGMENTOS 0.25mm O/S	PISTON RING SET 0.25mm O/S	KIT FASCE 0.25mm O/S	KIT SEGMENTS 0.25mm O/S	2
	REC66T-11605-00	66T-11605-00	KIT SEGMENTOS 0.50mm O/S	PISTON RING SET 0.50mm O/S	KIT FASCE 0.50mm O/S	KIT SEGMENTS 0.50mm O/S	
34	REC93102-30M56	93102-30M56	RETÉN DE ACEITE	OIL SEAL	PARAOILIO	JOINT SPI	2
35	REC93101-16001	93101-16001	RETÉN DE ACEITE	OIL SEAL	PARAOILIO	JOINT SPI	2
36	REC93210-65M50	93210-65M50	TÓRICA	O-RING	O-RING	JOINT TORIQUE	1
37	REC66T-45113-A0	66T-45113-A00	JUNTA BASE MOTOR	GASKET ENGINE	GUARNIZIONE BASE MOTORE	JOINT DE TETE MOTRICE	1

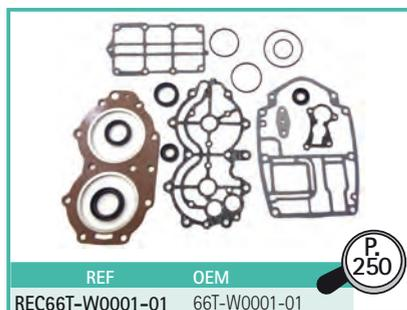

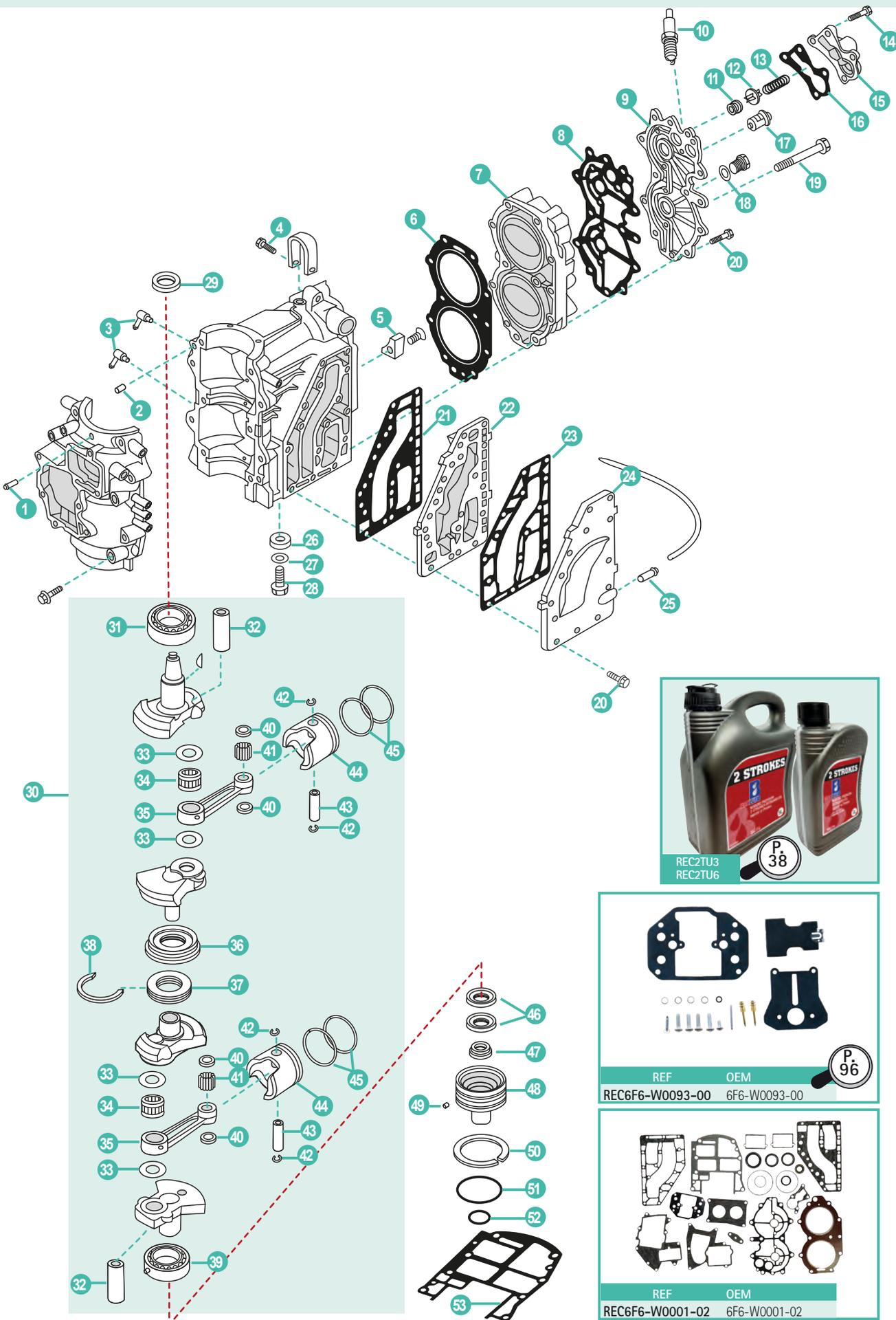

P 38



REF	OEM
REC6F6-W0093-00	6F6-W0093-00

P 96

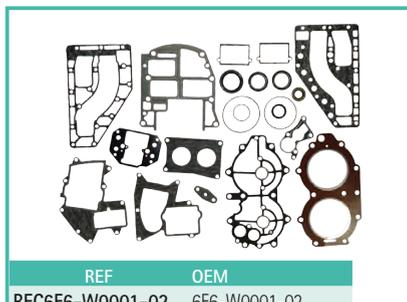

REF	OEM
REC6F6-W0001-02	6F6-W0001-02

	REF	OEM					UN.
1	PAT15-04010202	624-14485-00	PIPA DE AGUA	PIPE, WATER	TUBO	RACCORD TUYAU D'EAU	1
2	PAF25-00000014	93608-12063	PIN CENTRADOR	HOLLOW PIN	SPINOTTO DI CENTRAGGIO	PIN DE CENTRAGE	2
3	REC650-11370-00	650-11370-01	NIPLE DE MANGUERA	NIPPLE	TUBO	RACCORD D'EAU	2
4	PAGB/T5783-M8X35	90101-08001	TORNILLO	BOLT	VITE	VIS	1
5	TEN01166	676-11325-00	ÁNODO	ANODO	ANODO	ANODE	1
6	REC6F5-11181-A2	6F5-11181-A1	JUNTA CULATA	GASKET, CYLINDER HEAD	GUARNIZIONE TESTATA	JOINT DE CULASSE	1
7	REC6F6-11111-00-1S	6F6-11111-00-1S	CULATA DE CILINDRO	CYLINDER HEAD	TESTA CILINDRO	CULASSE	1
8	REC6F6-11193-A1	6F6-11193-A1	JUNTA TAPA	GASKET, COVER	GUARNIZIONE COPERCHIO	JOINT DE COUVRE CULASSE	1
9	REC6F6-11191-00-1S	6F6-11191-00-1S	TAPA CULATA DE CILINDRO	HEAD CYLINDER COVER	COPERCHIO TESTATA CILINDRO	CUVERCLE DE CULASSE	1
10	NGKB7HS	94702-00040	BUJÍA	SPARK PLUG	CANDELA	BOUGIE	2
11	REC90480-18065	90480-18065	TAPÓN	PLUG	TAPPO	BOUCHON	1
12	REC663-12416-00	663-12416-00	VÁLVULA DE PRESIÓN	VALVE, PRESS CONTROL	VALVOLA DI PRESSIONE	SOUPAPE DE PRESSION	1
13	REC90501-14M02	90501-14M02	RESORTE DE COMPRESIÓN	SPRING COMPRESSION	MOLLA DI COMPRESIONE	RESSORT	1
14	PAGB/T5783-M6X30	90119-06MA4	TORNILLO CON ARANDELA	BOLT, FLANGE	VITE CON RONDELLA	VIS DE BRIDE	4
15	REC6E9-12413-00-1S	6E9-12413-00-1S	TAPA TERMOSTATO	COVER, THERMOSTAT	COPERCHIO TERMOSTATO	COUVERCLE THERMOSTAT	1
16	REC6E9-12414-A1	6E9-12414-A1	JUNTA TAPA TERMOSTATO	GASKET, THERMOSTAT COVER	GUARNIZIONE COPERCHIO TERMOSTATO	JOINT COUVERCLE DE THERMOSTAT	1
17	REC6F5-12411-03	6F5-12411-02	TERMOSTATO	THERMOSTAT	TERMOSTATO	THERMOSTAT	1
18	PAF15-04000003	90430-14115	JUNTA	GASKET	GUARNIZIONE	JOINT	1
19	PAGB/T5783-M6X25	90119-08MA5	TORNILLO	BOLT	VITE	VIS	11
20	PAGB/T5783-M6X25	90119-06MA3	TORNILLO CON ARANDELA	BOLT, FLANGE	VITE CON RONDELLA	VIS DE BRIDE	20
21	REC6F5-41112-A0	6F5-41112-A0	JUNTA DE ESCAPE	EXHAUST GASKET	GUARNIZIONE DI SCARICO	JOINT D'ECHAPPEMENT	1
22	REC6F5-41111-01-1S	6F5-41111-01-1S	CUBIERTA INTERIOR DE ESCAPE	INNER EXHAUST COVER	COPERCHIO INTERIORE SCARICO	COUVERCLE INTERIEUR D'ECHAPPEMENT	1
23	REC6F5-41114-A0	6F5-41114-A0	JUNTA EXTERIOR, TAPA DE ESCAPE	GASKET, EXHAUST OUTER COVER	GUARNIZIONE ESTERIORE, COPERCHIO SCARICO	JOINT DE COUVERCLE EXT ECHAPPEMENT	1
24	REC6F5-41113-A0-1S	6F5-41113-01-1S	CUBIERTA EXTERIOR DE ESCAPE	OUTTER EXHAUST COVER	COPERCHIO ESTERNO SCARICO	COUVERCLE EXTERIEUR D'ECHAPPEMENT	1
25	PAF4-04010102	650-24378-00	PIPA DE AGUA	PIPE, WATER	TUBO	RACCORD TUYAU D'EAU	1
26	TEN01127	676-45251-00	ÁNODO	ANODE	ANODO	ANODE	1
27	PAGB/T97.1-6	92995-06600	ARANDELA	WASHER	RONDELLA	RONDELLE	1
28	PAGB/T5783-M6X16	97095-06016	TORNILLO	BOLT	VITE	VIS	1
29	REC93102-35M18	93102-35M18	RETÉN DE ACEITE	OIL SEAL	PARAOILIO	JOINT SPI	1
30	REC6F6-11400-02	6F6-11400-01	CIGÜEÑAL COMPLETO	CRANK ASSY	ALBERO MOTORE COMPLETO	VILEBREQUIN COMPLET	1
31	REC93306-307U0	93306-307U0	RODAMIENTO	BALL BEARING	CUSCINETTO	ROULEMENT À BILLE	1
32	REC6F5-11681-00	6F5-11681-00	PIN	PIN	SPINOTTO	PIN D'ENTRAINEMENT	2
33	REC90209-27M07	90209-27M07	ARANDELA DE SEPARACIÓN	WASHER	RONDELLA DISTANZIALE	RONDELLE	14
34	REC93310-727V7	93310-727V7	COJINETE DE BIELA	BEARING, CONNECTING ROD	CUSCINETTO BIELLA	PALIER DE BIELLE	2
35	REC6F5-11651-00	6F5-11651-00	BIELA	ROD, CONNECTING	BIELLA	BIELLE	2
36	REC93332-000UE	93332-000UE	COJINETE	BEARING	CUSCINETTO	PALIER	1
37	REC6F5-11515-00	6F5-11515-00	SELLO LABERINTO	LABERINTH SEAL	GUARNIZIONE SIGILLATA	JOINT	1
38	REC93440-68M03	93440-68M03	CIRCLIP	CIRCLIP	CIRCLIP	CIRCLIP	1
39	REC93306-306V1	93306-303V1	COJINETE	BEARING	CUSCINETTO	PALIER	1
40	REC90201-20417	90201-20417	ARANDELA PLANA	FLAT WASHER	RONDELLA PIANA	RONDELLE	4
41	REC93603-21111	93603-21111	AGUJA PASADOR	NEEDLE PIN	SPILLO	CLAVETTE	56
42	REC663-11634-00	663-11634-00	CIRCLIP	CIRCLIP	CIRCLIP	CIRCLIP	4
43	REC6F5-11633-00	6F5-11633-00	PIN, PISTÓN	PIN, PISTON	SPINOTTO PISTONE	AXE DE PISTON	2
	REC6F6-11631-00K	6F6-11631-00-95	PISTÓN STD	PISTON STD	PISTONE STD	PISTON STD	
44	REC6F6-11635-00K	6F6-11635-00	PISTÓN 0.25mm O/S	PISTON 0.25mm O/S	PISTONE 0.25mm O/S	PISTON 0.25mm O/S	2
	REC6F6-11636-00K	6F6-11636-00	PISTÓN 0.50mm O/S	PISTON 0.50mm O/S	PISTONE 0.50mm O/S	PISTON 0.50mm O/S	
	REC6F5-11610-00	6F6-11610-00	KIT SEGMENTOS STD	PISTON RING SET STD	KIT FASCE STD	KIT SEGMENTS STD	
45	REC6F5-11610-10	6F6-11610-010	KIT SEGMENTOS 0.25mm O/S	PISTON RING SET 0.25mm O/S	KIT FASCE 0.25mm O/S	KIT SEGMENTS 0.25mm O/S	2
	REC6F5-11610-20	6F6-11610-20	KIT SEGMENTOS 0.50mm O/S	PISTON RING SET 0.50mm O/S	KIT FASCE 0.50mm O/S	KIT SEGMENTS 0.50mm O/S	
46	REC93101-30M33	93101-30M33	RETÉN DE ACEITE	OIL SEAL	PARAOILIO	JOINT SPI	2
47	REC93104-16M01	93104-16M01	RETÉN DE ACEITE	OIL SEAL	PARAOILIO	JOINT SPI	1
48	REC6F5-15396-01-5B	6F5-15396-01-5B	CUERPO DEL RETÉN	SHELL, OIL SEAL	GUARNIZIONE CORPO	LOGEMENT JOINT SPI	1
49	PAGB/T879.4-3X20	91690-30010	PASADOR DE RESORTE	PIN, SPRING	SPINOTO DI RITORNO	GOUPILLE FENDUE	1
50	REC93440-68M03	93440-68M03	CIRCLIP	CIRCLIP	CIRCLIP	CIRCLIP	1
51	REC93210-65M50	93210-65M50	TÓRICA	O-RING	O-RING	JOINT TORIQUE	1
52	REC93210-22M02	93210-22M02	TÓRICA	O-RING	O-RING	JOINT TORIQUE	1
53	REC6F5-45113-A0	6F5-45113-A0	JUNTA BASE MOTOR	GASKET ENGINE	GUARNIZIONE BASE MOTORE	JOINT DE TETE MOTRICE	1

2T  
STROKES

25Q/QEO · 40A/C · 40ELR · 40H/HE · 40MLHZ · 40O/OS · 40TLR · 40V/VE/VEO/VETO/VMHO · 40YETO/Z  
50D/DE · 50H/HEDO/HETO/HMHD/HWHDLO/HRDO · 50MTO

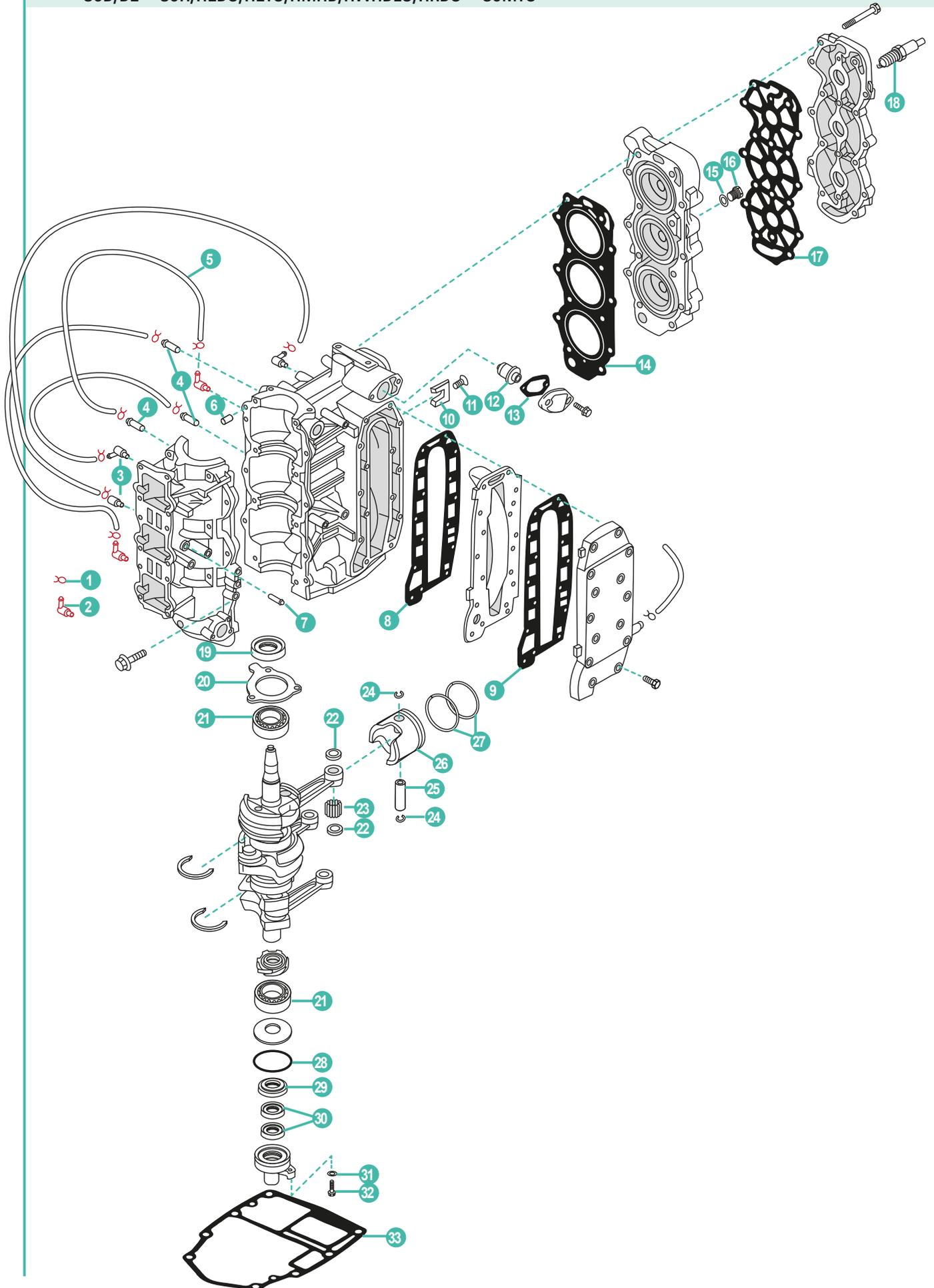

YAMAHA

RECAMBIOS  
MARINOS

	REF	OEM				UN.	
1	PAHT-2.5X60	90467-06016	CLIP	CLIP	CLIP	CLIP	8
2	REC688-11370-00	688-11370-01	NIPL DE MANGUERA	NIPPLE	TUBO	RACCORD D'EAU	2
3	REC650-11370-00	650-11370-01	NIPL DE MANGUERA	NIPPLE	TUBO	RACCORD D'EAU	2
4	REC624-14485-00	624-14485-00	PIPA DE AGUA	PIPE, WATER	TUBO	RACCORD TUYAU D'EAU	3
5	PAF2.6-04000015	90445-07MA3	TUBO L200	HOSE L200	TUBO L200	TUYAU L200	1
6	REC93606-12019	93606-12019	PIN CENTRADOR	HOLLOW PIN	SPINOTTO DI CENTRAGGIO	PIN DE CENTRAGE	2
7	PAF4-04010102	650-24378-00	PIPA DE AGUA	PIPE, WATER	TUBO	RACCORD TUYAU D'EAU	1
8	REC6H4-41112-A0	6H4-41112-A0	JUNTA DE ESCAPE	EXHAUST GASKET	GUARNIZIONE DI SCARICO	JOINT D'ECHAPPEMENT	1
9	REC6H4-41114-A0	6H4-41114-A0	JUNTA EXTERIOR, TAPA DE ESCAPE	GASKET, EXHAUST OUTER COVER	GUARNIZIONE ESTERIORE, COPERCHIO SCARICO	JOINT DE COUVERCLE EXT ECHAPPEMENT	1
10	TEN01147	688-11325-00	ÁNODO	ANODE	ANODO	ANODE	2
11	PAGB/T820-M4X12	98780-04016	TORNILLO	SCREW	VITE	VIS	2
12	REC6E5-12411-30	6E5-12411-30	TERMOSTATO	THERMOSTAT	TERMOSTATO	THERMOSTAT	1
13	REC61A-12414-A0	6J8-12414-A0	JUNTA TAPA TERMOSTATO	GASKET, THERMOSTAT COVER	GUARNIZIONE COPERCHIO TERMOSTATO	JOINT COUVERCLE DE THERMOSTAT	1
14	REC63D-11181-A1	63D-11181-A2	JUNTA CULATA	GASKET, CYLINDER HEAD	GUARNIZIONE TESTATA	JOINT DE CULASSE	1
15	PAF15-04000003	90430-14115	JUNTA	GASKET	GAURNIZIONE	JOINT	1
16	PAF15-04000002	90340-14M00	TAPÓN	PLUG	TAPPO	BOUCHON	1
17	REC63D-11193-A0	63D-11193-A0	JUNTA TAPA	GASKET, COVER	GUARNIZIONE COPERCHIO	JOINT COUVERCLE	1
18	NGKBR8HS-10	94702-00247	BUJÍA	SPARK PLUG	CANDELA	BOUGIE	3
18	NGKBR7HS-10	94702-00271	BUJÍA	SPARK PLUG	CANDELA	BOUGIE	
19	REC93102-23096	93102-23096	RETÉN DE ACEITE	OIL SEAL	PARAOLIO	JOINT SPI	1
20	REC6H4-15369-A1	6H4-15369-A1	JUNTA DE CUERPO	GASKET, OIL SEAL HOUSING	GUARNIZIONE CORPO	JOINT	1
21	REC93306-305U8	93306-305-U8	RODAMIENTO	BEARING	CUSCINETTO	PALIER	2
22	REC6H4-11641-00	6H4-11641-00	ARANDELA	WASHER	RONDELLA	RONDELLE	6
23	REC93602-20M02	93602-20M02	AGUJA DE RODAMIENTO	BEARING NEEDLE	SPILLO DE CUSCINETTO	CLAVETTE DE PALIER	93
24	REC6H4-11634-01	6H4-11634-01	CIRCLIP	CIRCLIP	CIRCLIP	CIRCLIP	6
25	REC648-11633-00	648-11633-00	PIN, PISTÓN	PIN, PISTON	SPINOTTO PISTONE	AXE DE PISTON	3
	REC6H4-11631-01K	6H4-11631-01-95	PISTÓN STD	PISTON STD	PISTONE STD	PISTON STD	
26	REC6H4-11635-01K	6H4-11635-01	PISTÓN 0.25mm O/S	PISTON 0.25mm O/S	PISTONE 0.25mm O/S	PISTON 0.25mm O/S	3
	REC6H4-11636-01K	6H4-11636-01	PISTÓN 0.50mm O/S	PISTON 0.50mm O/S	PISTONE 0.50mm O/S	PISTON 0.50mm O/S	
27	REC63D-11603-00	63D-11603-00	KIT SEGMENTOS STD	PISTON RING SET STD	KIT FASCE STD	KIT SEGMENTS STD	3
	REC63D-11605-00	63D-11605-00	KIT SEGMENTOS DE PISTÓN 0.50mm O/S	PISTON RING SET 0.50mm O/S	KIT FASCE 0.50mm O/S	KIT SEGMENTS 0.50mm O/S	
28	REC93210-58M21	93210-58M21	TÓRICA	O-RING	O-RING	JOINT TORIQUE	1
29	REC93102-25M28	93102-25M28	RETÉN DE ACEITE	OIL SEAL	PARAOLIO	JOINT SPI	1
30	REC93104-16M01	93104-16M01	RETÉN DE ACEITE	OIL SEAL	PARAOLIO	JOINT SPI	2
31	PAGB/T5783-M5X12	92995-06600	ARANDELA	WASHER	RONDELLA	RONDELLE	1
32	PAGB/T5783-M6X20	97095-06020	TORNILLO	BOLT	VITE	VIS	1
33	REC6H4-45113-00	6H4-45113-00	JUNTA BASE MOTOR	GASKET ENGINE	GUARNIZIONE BASE MOTORE	JOINT DE TETE MOTRICE	1

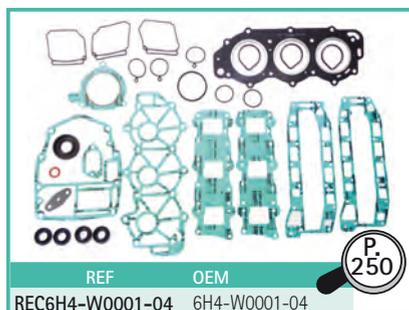
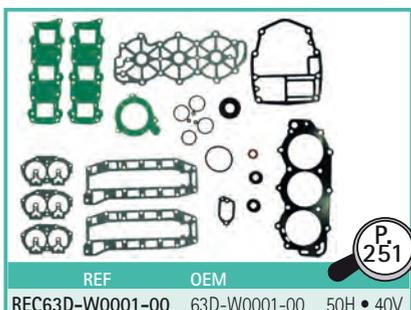

2T  
STROKES

E48C/CMH • 55B/BM/BET • E55C/CMH • 55ED • 55ET

YAMAHA

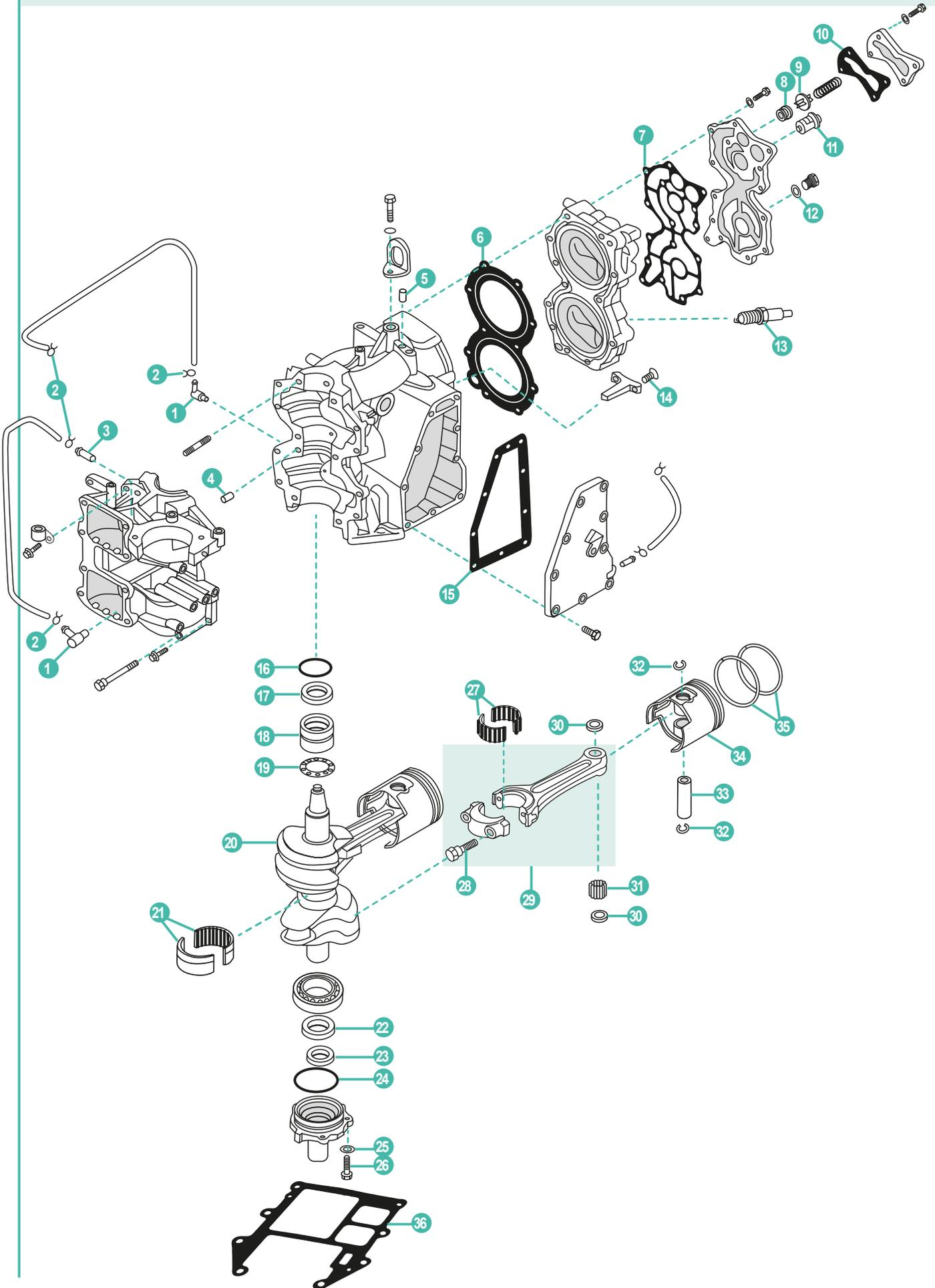

RECAMBIOS  
MARINOS



	REF	OEM				UN.	
1	REC650-11370-00	650-11370-01	NIPLE DE MANGUERA	NIPPLE	TUBO	RACCORD D'EAU	2
2	PAHT-2.5X60	90467-06016	PRESILLA	CLIP	CLIP	CLIP	4
3	REC624-14485-00	624-14485-00	PIPA DE AGUA	PIPE, WATER	TUBO	RACCORD TUYAU D'EAU	1
4	PAF25-00000014	93608-12063	PIN CENTRADOR	HOLLOW PIN	SPINOTTO DI CENTRAGGIO	PIN DE CENTRAGE	1
5	PAF25-04000007	93604-08062	PIN CENTRADOR	HOLLOW PIN	SPINOTTO DI CENTRAGGIO	PIN DE CENTRAGE	1
6	REC697-11181-A1	697-11181-A2	JUNTA CULATA	GASKET, CYLINDER HEAD	GUARNIZIONE TESTATA	JOINT DE CULASSE	1
7	REC663-11193-00	663-11193-A0	JUNTA TAPA	GASKET, COVER	GUARNIZIONE COPERCHIO	JOINT DE COUVRE CULASSE	1
8	REC90480-18065	90480-18065	TAPÓN	GROMMET	TAPPO	BOUCHON	1
9	REC663-12416-00	663-12416-00	VÁLVULA DE PRESIÓN	VALVE, PRESSURE CONTROL	VALVOLA DI PRESSIONE	SOUPAPE DE PRESION	1
10	REC663-12414-00	663-12414-A0	JUNTA TAPA TERMOSTATO	GASKET, THERMOSTAT COVER	GUARNIZIONE COPERCHIO TERMOSTATO	JOINT COUVERCLE DE THERMOSTAT	1
11	REC6F5-12411-03	6F5-12411-02	TERMOSTATO	THERMOSTAT	TERMOSTATO	THERMOSTAT	1
12	PAF15-04000003	90430-14115	JUNTA	GASKET	GUARNIZIONE	JOINT	1
	NGKB8HS-10	94702-00160	BUJÍA 55E	SPARK PLUG 55E	CANDELA 55E	BOUGIE 55E	
13	NGKB7HS	94702-00040	BUJÍA E48	SPARK PLUG E48	CANDELA E48	BOUGIE E48	2
	NGKB8HS	94702-00041	BUJÍA E55C	SPARK PLUG E55C	CANDELA E55C	BOUGIE E55C	
14	PAGB/T820-M4X12	98780-04015	TORNILLO CABEZA PLANA	SCREW, FLAT HEAD	VITE TESTA PLANA	VIS	2
15	REC663-41114-00	663-41114-A0	JUNTA DE ESCAPE	EXHAUST GASKET	GUARNIZIONE DI SCARICO	JOINT D'ECHAPPEMENT	1
16	REC93210-42159	93210-42159	TÓRICA	O-RING	O-RING	JOINT TORIQUE	1
17	REC93102-32M07	93102-32M07	RETÉN DE ACEITE	OIL SEAL	PARAOLIO	JOINT SPI	1
18	REC93311-632U1	93311-632U1	COJINETE DE RODILLOS	BEARING	CUSCINETTO A RULLI	ROULEMENT À BILLE	1
19	REC663-11561-00	663-11561-00	ARANDELA PLANA	CHIM, RANK	SPESSORE		1
20	REC663-11411-00	663-11411-01	CIGÜEÑAL	CRANK SHAFT	ALBERO MOTORE	VILEBREQUIN	1
21	REC93311-832U4	93311-832U4	COJINETE DE RODILLOS	BEARING	CUSCINETTO A RULLI	ROULEMENT À BILLE	1
22	REC93102-28135	93102-28135	RETÉN DE ACEITE	OIL SEAL	PARAOLIO	JOINT SPI	1
23	REC93104-18049	93104-18049	RETÉN DE ACEITE	OIL SEAL	PARAOLIO	JOINT SPI	1
24	REC93210-62269	93210-62269	TÓRICA	O-RING	O-RING	JOINT TORIQUE	1
25	PAGB/T97.1-6	92995-06600	ARANDELA	WASHER	RONDELLA	RONDELLE	3
26	PAGB/T5783-M6X16	97095-06016	PERNO	BOLT	PERNO	BOULON	3
27	REC93310-730V8	93310-730V8	COJINETE DE RODILLOS	BEARING	CUSCINETTO A RULLI	ROULEMENT À BILLE	2
28	REC90109-08022	90109-08022	PERNO	BOLT	PERNO	BOULON	2
29	REC688-11650-03	688-11650-03	BIELA COMPLETA	CONNECTING ROD ASSY	BIELLA COMPLETA	BIELLE COMPLÈTE	2
30	REC90201-20417	90201-20417	ARANDELA PLANA	WASHER	RONDELLA PIANA	RONDELLE	4
31	REC93603-21111	93603-21111	AGUJA DE RODAMIENTO	BEARING NEEDLE	SPILLO DE CUSCINETTO	CLAVETTE DE PALIER	56
32	REC688-11634-00	688-11634-00	CIRCLIP	CIRCLIP	CIRCLIP	CIRCLIP	4
33	REC663-11633-00	663-11633-00	PIN, PISTÓN	PIN, PISTON	SPINOTTO PISTONE	AXE DE PISTON	2
	REC688-11631-03K	688-11631-03-94	PISTÓN STD	PISTON STD	PISTONE STD	PISTON STD	
34	REC688-11635-03K	688-11635-03	PISTÓN 0.25mm O/S	PISTON 0.25mm O/S	PISTONE 0.25mm O/S	PISTON 0.25mm O/S	2
	REC688-11636-03K	688-11636-03	PISTÓN 0.50mm O/S	PISTON 0.50mm O/S	PISTONE 0.50mm O/S	PISTON 0.50mm O/S	
	REC688-11603-A0	688-11603-A0	KIT SEGMENTOS STD	PISTON RING SET STD	KIT FASCE STD	KIT SEGMENTS STD	
35	REC688-11605-A0	688-11605-A0	KIT SEGMENTOS DE PISTÓN 0.50mm O/S	PISTON RING SET 0.50mm O/S	KIT FASCE 0.50mm O/S	KIT SEGMENTS 0.50mm O/S	2
36	REC696-45113-00	696-45113-00	JUNTA BASE MOTOR	GASKET ENGINE	GUARNIZIONE BASE MOTORE	JOINT DE TETE MOTRICE	1

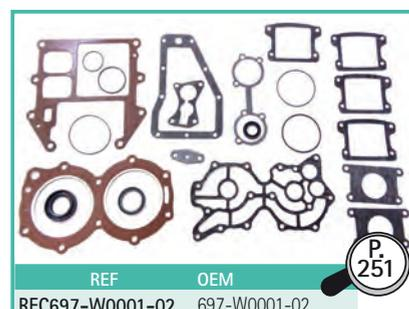

2T  
STROKES

50G/GEO/GETO • 60F/FEDO/FEHT/FEO/FET/FETO • 60TDR/TLR-B/TR-Z • 70B/BEHDO/BEMO/BEO/BETO • 70TDR/TR

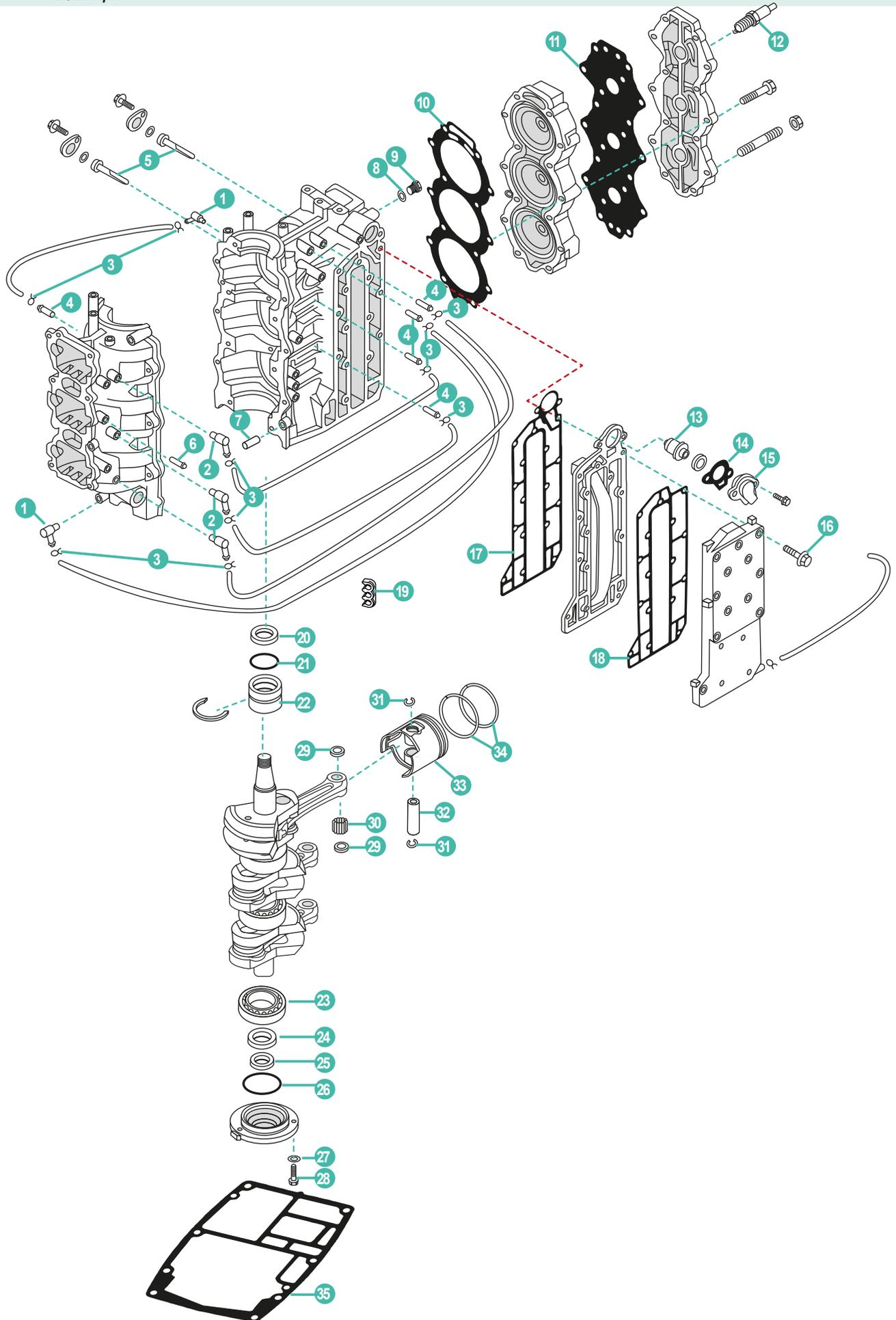

YAMAHA

RECAMBIOS  
MARINOS

	REF	OEM				UN.	
1	REC688-11370-00	688-11370-01	NIPLE DE MANGUERA	NIPPLE	TUBO	RACCORD D'EAU	2
2	REC650-11370-00	650-11370-01	NIPLE DE MANGUERA	NIPPLE	TUBO	RACCORD D'EAU	3
3	PAHT-2.5X60	90467-06016	CLIP	CLIP	CLIP	CLIP	10
4	REC624-14485-00	624-14485-00	PIPA DE AGUA	PIPE, WATER	TUBO	RACCORD TUYAU D'EAU	5
5	CM6H3-11325-01A	6H3-11325-01	ÁNODO	ANODE	ANODO	ANODE	2
6	PAF4-04010102	650-24378-00	PIPA DE AGUA	PIPE, WATER	TUBO	RACCORD TUYAU D'EAU	4
7	PAF25-00000014	93608-12063	PIN CENTRADOR	HOLLOW PIN	SPINOTTO DI CENTRAGGIO	PIN DE CENTRAGE	2
8	PAF15-04000003	90430-14115	JUNTA	GASKET	GUARNIZIONE	JOINT	1
9	PAF15-04000002	90340-14M00	TAPÓN	PLUG STRAIGHT SREW	TAPPO	BOUCHON	1
10	REC6H3-11181-A0	6H3-11181-A2	JUNTA CULATA	GASKET, CYLINDER HEAD	GUARNIZIONE TESTATA	JOINT DE CULASSE	1
11	REC6H3-11193-A1	6H3-11193-A1	JUNTA CULATÍN	GASKET COVER	GUARNIZIONE COPERCHIO	JOINT DE COUVRE CULASSE	1
12	NGKBR8HS-10	94702-00247	BUJÍA	SPARK PLUG	CANDELA	BOUGIE	3
13	REC6H3-12411-10	6H3-12411-10	TERMOSTATO	THERMOSTAT	TERMOSTATO	THERMOSTAT	1
14	REC6H3-12414-A1	6H3-12414-A1	JUNTA TAPA TERMOSTATO	GASKET, THERMOSTAT COVER	GUARNIZIONE COPERCHIO TERMOSTATO	JOINT COUVERCLE DE THERMOSTAT	1
15	PAF15-07010021	6H3-12413-00-1S	TAPA TERMOSTATO	COVER, THERMOSTAT	COPERCHIO TERMOSTATO	COUVERCLE DE THERMOSTAT	1
16	PAGB/T5782-M6X35	90119-06MA5	TORNILLO	BOLT	VITE	VIS	16
17	REC6H3-41112-A0	6H3-41112-A0	JUNTA DE ESCAPE	EXHAUST GASKET	GUARNIZIONE DI SCARICO	JOINT D'ECHAPPEMENT	1
18	REC6H3-41114-A0	6H3-41114-A0	JUNTA EXTERIOR, TAPA DE ESCAPE	GASKET, EXHAUST OUTER COVER	GUARNIZIONE ESTERIORE, COPERCHIO SCARICO	JOINT DE COUVERCLE EXT ECHAPPEMENT	1
19	PAF25-05000016	90464-07M05	ABRAZADERA	CLAMP	FASCETTA	COLLIER	1
20	REC93102-36M24	93102-36M24	RETÉN DE ACEITE	OIL SEAL	PARAOLIO	JOINT SPI	1
21	REC93210-46M16	93210-46M16	TÓRICA	O-RING	O-RING	JOINT TORIQUE	1
22	REC93311-636U6	93311-636U6	RODAMIENTO	BEARING	CUSCINETTO	ROULEMENT À BILLE	1
23	REC93306-306V1	93306-306V1	RODAMIENTO	BEARING	CUSCINETTO	ROULEMENT À BILLE	1
24	REC93102-30M23	93102-30M23	RETÉN DE ACEITE	OIL SEAL	PARAOLIO	JOINT SPI	1
25	REC93106-18M01	93106-18M01	RETÉN DE ACEITE	OIL SEAL	PARAOLIO	JOINT SPI	1
26	REC93210-65M50	93210-65M50	TÓRICA	O-RING	O-RING	JOINT TORIQUE	1
27	PAGB/T97.1-8	92995-06600	ARANDELA	WASHER	RONDELLA	RONDELLE	3
28	PAGB/T5783-M6X20	97095-06020	TORNILLO	BOLT	VITE	VIS	3
29	REC90201-20417	90201-20417	ARANDELA	WASHER	RONDELLA	RONDELLE	6
30	REC93603-18M09	93603-18M09	AGUJA DE RODAMIENTO	BEARING NEEDLE	SPILLO DE CUSCINETTO	CLAVETTE DE PALIER	84
31	REC688-11634-00	688-11634-10	CIRCLIP	CIRCLIP	CIRCLIP	CIRCLIP	6
32	REC6H3-11633-00	6H3-11633-00	PIN, PISTÓN	PIN, PISTON	SPINOTTO PISTONE	AXE DE PISTON	3
	REC6H3-11631-01K	6H3-11631-01-96	PISTÓN STD	PISTON STD	PISTONE STD	PISTON STD	
33	REC6H3-11635-01K	6H3-11635-01	PISTÓN 0.25mm O/S	PISTON 0.25mm O/S	PISTONE 0.25mm O/S	PISTON 0.25mm O/S	3
	REC6H3-11636-01K	6H3-11636-01	PISTÓN 0.50mm O/S	PISTON 0.50mm O/S	PISTONE 0.50mm O/S	PISTON 0.50mm O/S	
	REC6K5-11601-02	6K5-11601-02	KIT SEGMENTOS STD	PISTON RING SET STD	KIT FASCE STD	KIT SEGMENTS STD	
34	REC6K5-11601-12	6K5-11601-12	KIT SEGMENTOS DE PISTÓN 0.25mm O/S	PISTON RING SET 0.25mm O/S	KIT FASCE 0.25mm O/S	KIT SEGMENTS 0.25mm O/S	3
	REC6K5-11601-22	6K5-11601-22	KIT SEGMENTOS DE PISTÓN 0.50mm O/S	PISTON RING SET 0.50mm O/S	KIT FASCE 0.50mm O/S	KIT SEGMENTS 0.50mm O/S	
35	REC6H3-45113-00	6H3-45113-00	JUNTA BASE MOTOR	GASKET ENGINE	GUARNIZIONE BASE MOTORE	JOINT DE TETE MOTRICE	1

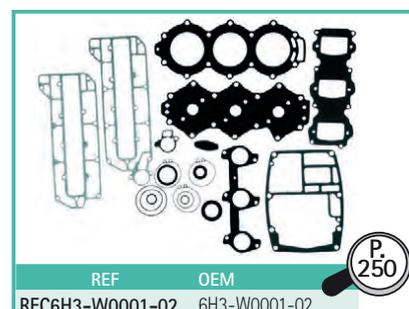

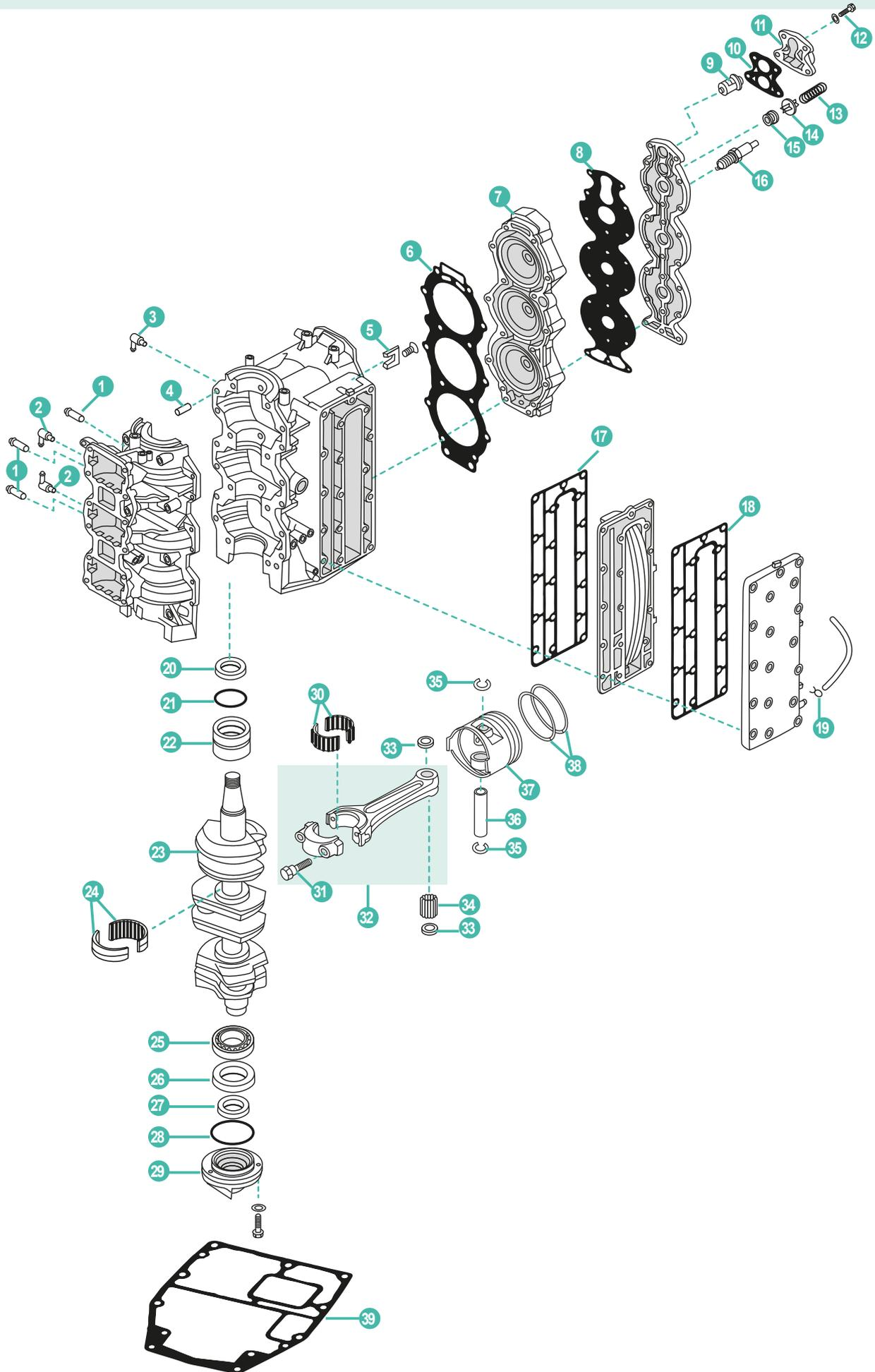

	REF	OEM				UN.	
1	REC624-14485-00	624-14485-00	PIPA DE AGUA	PIPE, WATER	TUBO	RACCORD TUYAU D'EAU	4
2	REC688-11370-00	688-11370-01	NIPLE DE MANGUERA	NIPPLE	TUBO	RACCORD D'EAU	2
3	REC650-11370-00	650-11370-01	NIPLE DE MANGUERA	NIPPLE	TUBO	RACCORD D'EAU	1
4	PAF25-00000014	93608-12063	PIN CENTRADOR	HOLLOW PIN	SPINOTTO DI CENTRAGGIO	PIN DE CENTRAGE	2
5	TEN01147	688-11325-00	ÁNODO	ANODE	ANODO	ANODE	2
6	REC688-11181-A1	688-11181-A1	JUNTA CULATA	GASKET, CYLINDER HEAD	GUARNIZIONE TESTATA	JOINT DE CULASSE	1
7	REC688-11111-02-1S	688-11111-02-1S	CULATA	CYLINDER HEAD	TESTATA	CULASSE	1
8	REC688-11193-A1	688-11193-A1	JUNTA TAPA	GASKET, COVER	GUARNIZIONE COPERCHIO	JOINT DE COUVRE CULASSE	1
9	REC6E5-12411-30	688-12411-10	TERMOSTATO	THERMOSTAT	TERMOSTATO	THERMOSTAT	1
10	REC688-12414-A1	688-12414-A1	JUNTA TAPA TERMOSTATO	GASKET, THERMOSTAT COVER	GUARNIZIONE COPERCHIO TERMOSTATO	JOINT COUVERCLE DE THERMOSTAT	1
11	REC688-12413-00-1S	688-12413-00-1S	TAPA TERMOSTATO	COVER, THERMOSTAT	COPERCHIO TERMOSTATO	COUVERCLE DE THERMOSTAT	1
12	PAGB/T5783-M6X35	90119-06MA5	TORNILLO	BOLT, WITH WASHER	VITE	VIS	4
13	REC90501-16M11	90501-16M11	MUELLE	SPRING COMPRESSION	MOLLA	RESSORT	1
14	REC688-12416-00	688-12416-00	VÁLVULA CONTROL DE PRESIÓN	VALVE, PRESSURE CONTROL	VALVOLA ANTIPRESSIONE	SOUPAPE DE DEPRESSION	1
15	REC90480-20M05	90480-20M05	JUNTA GOMA	GROMMET	GUARNIZIONE GOMMA	JOINT	1
16	NGKB8HS-10	90472-00247	BUJÍA	SPARK PLUG	CANDELA	BOUGIE	3
17	REC688-41112-A0	688-41112-A0	JUNTA DE ESCAPE	EXHAUST GASKET	GUARNIZIONE DI SCARICO	JOINT D'ECHAPPEMENT	1
18	REC688-41114-A0	688-41114-A0	JUNTA EXTERIOR, TAPA DE ESCAPE	GASKET, EXHAUST OUTER COVER	GUARNIZIONE ESTERIORE, COPERCHIO SCARICO	JOINT DE COUVERCLE EXT ECHAPPEMENT	1
19	PAF4-04000030	90467-08004	PRESILLA	CLAMP	CLIP	CLIP	1
20	REC93102-36M02	93102-36M02	RETÉN DE ACEITE	OIL SEAL	PARAOLIO	JOINT SPI	1
21	REC93210-46M16	93210-46M16	TÓRICA	O-RING	O-RING	JOINT TORIQUE	1
22	REC93310-636U4	93310-636U4	RODAMIENTO	BEARING	CUSCINETTO	PALIER	1
23	REC688-11411-00	688-11411-01	CIGÜEÑAL	CRANK ASSY	ALBERO MOTORE	VILEBREQUIN	1
24	REC93310-835U8	93310-835U8	RODAMIENTO	BEARING	CUSCINETTO	ROULEMENT À BILLE	2
25	REC93306-206U5	93306-206U5	RODAMIENTO	BEARING	CUSCINETTO	ROULEMENT À BILLE	1
26	REC93102-30M05	93102-30M05	RETÉN DE ACEITE	OIL SEAL	PARAOLIO	JOINT SPI	1
27	REC93104-20M02	93104-20M02	RETÉN DE ACEITE	OIL SEAL	PARAOLIO	JOINT SPI	1
28	REC93210-62269	93210-62269	TÓRICA	O-RING	O-RING	JOINT TORIQUE	1
29	REC6H1-15359-01-94	6H1-15359-01-94	CUERPO DEL RETÉN	SHELL, OIL SEAL	GUARNIZIONE CORPO	LOGEMENT JOINT D'HUILE	1
30	REC93310-730V8	93310-730V8	COJINETE DE BIELA	BEARING, CONNECTING ROD	CUSCINETTO BIELLA	PALIER DE BIELLE	3
31	REC90109-08022	90109-08022	TORNILLO	BOLT	VITE	VIS	2
32	REC688-11650-03	688-11650-03	BIELA	CONNECTING ROD ASSY	BEILLA	BIELLE	3
33	REC90201-20417	90201-20417	ARANDELA	WASHER PLATE	RONDELLA	RONDELLE	6
34	REC93603-21111	93603-21111	AGUJA DE RODAMIENTO	BEARING NEEDLE	SPILLO DE CUSCINETTO	CLAVETTE DE PALIER	84
35	REC688-11634-00	688-11634-00	CIRCLIP	CIRCLIP	CIRCLIP	CIRCLIP	6
36	REC663-11633-00	663-11633-00	PIN, PISTÓN	PIN, PISTON	SPINOTTO PISTONE	AXE DE PISTON	3
37	REC688-11631-03K	688-11631-03-94	PISTÓN STD	PISTON STD	PISTONE STD	PISTON STD	3
38	REC688-11603-A0	688-11603-A0	KIT SEGMENTOS STD	PISTON RING SET STD	KIT FASCE STD	KIT SEGMENTS STD	3
	REC688-11605-A0	688-11605-A0	KIT SEGMENTOS DE PISTÓN 0.50mm O/S	PISTON RING SET 0.50mm O/S	KIT FASCE 0.50mm O/S	KIT SEGMENTS 0.50mm O/S	3
39	REC688-45113-A0	688-45113-A0	JUNTA BASE MOTOR	GASKET ENGINE	GUARNIZIONE BASE MOTORE	JOINT DE TETE MOTRICE	1

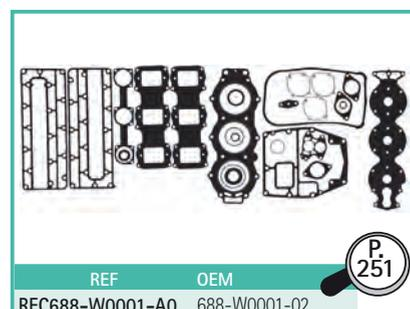

2T  
STROKES

100A/AETO • 100TLR • 115AEL/B/BETO/BE-TR/C/CEO/CETO • C115TLR • 130B/BETO • 130TLR/TLRZ • 140A • 140B

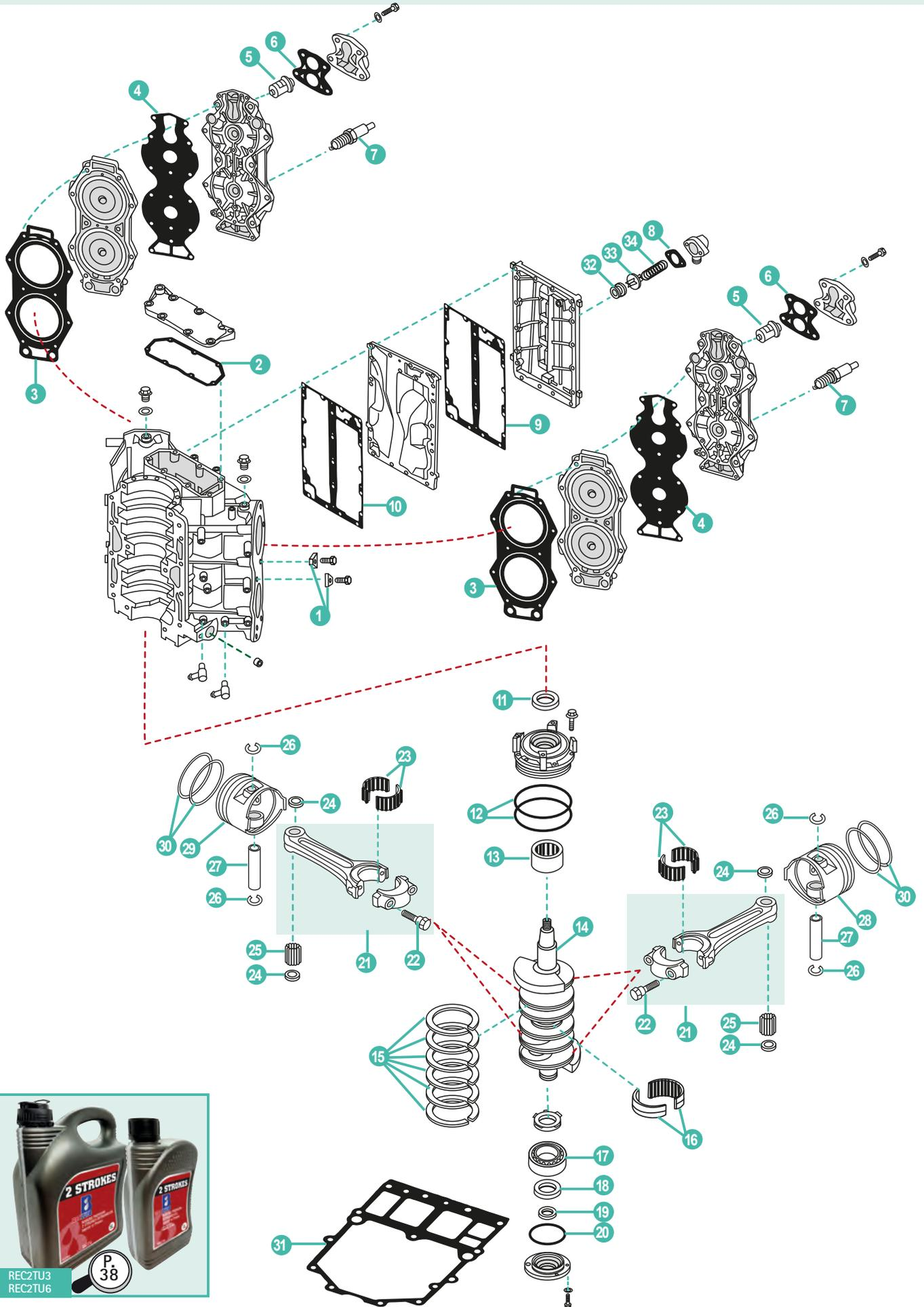

YAMAHA

RECAMBIOS  
MARINOS

	REF	OEM				UN.	
1	TEN01152	6E5-11325-00	ÁNODO	ANODE	ANODO	ANODE	4
2	REC6E5-11381-A1	6E5-11381-A2	JUNTA	GASKET	GUARNIZIONE	JOINT	1
3	REC6E5-11181-A0	6E5-11181-A2	JUNTA CULATA	GASKET, CYLINDER HEAD	GUARNIZIONE TESTATA	JOINT DE CULASSE	2
4	REC6E5-11193-A0	6E5-11193-A0	JUNTA CULATÍN	GASKET, HEAD COVER	GUARNIZIONE COPERCHIO TESTA	JOINT DE COUVRE CULASSE	2
5	REC6E5-12411-30	6E5-12411-30	TERMOSTATO	THERMOSTAT	TERMOSTATO	THERMOSTAT	2
6	REC688-12414-A1	688-12414-A1	JUNTA TAPA TERMOSTATO	GASKET, THERMOSTAT COVER	GUARNIZIONE COPERCHIO TERMOSTATO	JOINT COUVERCLE DE THERMOSTAT	2
7	NGKBR8HS-10	94702-00247	BUJÍA 100, 115	SPARK PLUG 100, 115	CANDELA 100, 115	BOUGIE 100, 115	4
	NGKBR9HS-10	94702-00309	BUJÍA 130	SPARK PLUG 130	CANDELA 130	BOUGIE 130	
8	REC6G5-11382-A1	6G5-11382-A1	JUNTA	GASKET	GUARNIZIONE	JOINT	1
9	REC6E5-41112-A1	6E5-41112-A1	JUNTA EXTERIOR, TAPA DE ESCAPE	GASKET, EXHAUST OUTER COVER	GUARNIZIONE ESTERIORE, COPERCHIO SCARICO	JOINT DE COUVERCLE EXT ECHAPPEMENT	1
10	REC6E5-41112-A1	6E5-41112-A1	JUNTA DE ESCAPE	EXHAUST GASKET	GUARNIZIONE DI SCARICO	JOINT D'ECHAPPEMENT	1
11	REC93102-40M14	93102-40M14	RETÉN DE ACEITE	OIL SEAL	PARAOLIO	JOINT SPI	1
12	REC93211-04001	93211-04001	TÓRICA	O-RING	O-RING	JOINT TORIQUE	2
13	REC93311-940U3	93311-940U3	RODAMIENTO	BALL BEARING	CUSCINETTO	ROULEMENT À BILLE	1
14	REC6N7-11411-00	6N7-11411-00	CIGÜEÑAL	CRANKSHAFT	ALBERO MOTORE	VILEBREQUIN	1
15	REC6E5-11447-00	6E5-11447-00	ARO	SEAL, CRANK	O-RING	JOINT TORIQUE	6
16	REC93310-954U1	93310-954U1	RODAMIENTO	BALL BEARING	CUSCINETTO	ROULEMENT À BILLE	1
17	REC93306-208U0	93306-208U0	RODAMIENTO	BALL BEARING	CUSCINETTO	ROULEMENT À BILLE	1
18	REC93102-35M13	93102-35M13	RETÉN DE ACEITE	OIL SEAL	PARAOLIO	JOINT SPI	1
19	REC93101-22M15	93101-22M15	RETÉN DE ACEITE	OIL SEAL	PARAOLIO	JOINT SPI	1
20	REC93210-74M35	93210-74M35	TÓRICA	O-RING	O-RING	JOINT TORIQUE	1
21	REC6R5-11650-10	6R5-116950-0	BIELA	CONNECTING ROD ASSY	BIELLA	BIELLE	4
22	REC90109-08M71	90109-08M71	TORNILLO	BOLT	VITE	VIS	8
23	REC93310-836V2	93310-836V2	COJINETE DE BIELA	BEARING, CONNECTING ROD	CUSCINETTO BIELLA	PALIER DE BIELLE	4
24	REC90201-23M01	90201-23M01	ARANDELA	WASHER	RONDELLA	RONDELLE	8
24	REC90201-21M75	90201-21M75	ARANDELA	WASHER	RONDELLA	RONDELLE	8
25	REC93310-32337	93310-323V6	AGUJA DE RODAMIENTO	BEARING NEEDLE	SPILLO DE CUSCINETTO	CLAVETTE DE PALIER	4
26	REC6R5-11634-00	6R5-11634-10	CIRCLIP	CIRCLIP	CIRCLIP	CIRCLIP	8
27	REC6R5-11633-00	6R5-11633-10	PIN, PISTÓN	PIN, PISTON	SPINOTTO PISTONE	AXE DE PISTON	4
28	REC6R5-11642-01K	6R5-11642-11-93	PISTÓN STD 2	PISTON STD 2	PISTONE STD 2	PISTON STD 2	2
29	REC6R5-11631-11K	6R5-11361-11-93	PISTÓN STD 1	PISTON STD 1	PISTONE STD 1	PISTON STD 1	2
	REC64D-11603-01	64D-11603-01	KIT SEGMENTOS DE PISTÓN STD	PISTON RING SET STD	KIT FASCE STD	KIT SEGMENTS STD	
30	REC64D-11604-01	64D-11604-01	KIT SEGMENTOS DE PISTÓN 0.25mm O/S	PISTON RING SET 0.25mm O/S	KIT FASCE 0.25mm O/S	KIT SEGMENTS 0.25mm O/S	4
	REC64D-11605-01	64D-11605-01	KIT SEGMENTOS DE PISTÓN 0.50mm O/S	PISTON RING SET 0.50mm O/S	KIT FASCE 0.50mm O/S	KIT SEGMENTS 0.50mm O/S	
31	REC6G5-45113-A1	6G5-45113-A1	JUNTA BASE MOTOR	GASKET ENGINE	GUARNIZIONE BASE MOTORE	JOINT DE TETE MOTRICE	1
32	REC90480-20M05	90480-20M05	JUNTA GOMA	GROMMET	GUARNIZIONE GOMMA	JOINT	1
33	REC60H-12416-00	60H-12416-00	VÁLVULA CONTROL DE PRESIÓN	VALVE, PRESSURE CONTROL	VALVOLA ANTIPRESSIONE	SOUPAPE DE DEPRESSION	1
34	REC90501-16M11	90501-16M11	MUELLE	SPRING COMPRESSION	MOLLA	RESSORT	1

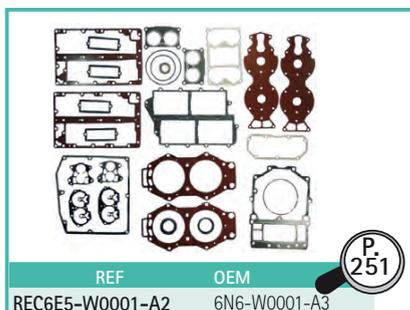

2T  
STROKES

150AET • 150F/FETO • 150L/SL150 • 150TR/150TXRA • D150H • 175D/DETO • S175 • L175 • 175D/DETO  
• S175 -L175 • 200AET • 200G/GETO • 200F/FETO • L200 • 200TLR • 225D/DET/DETO • L225A • L225B

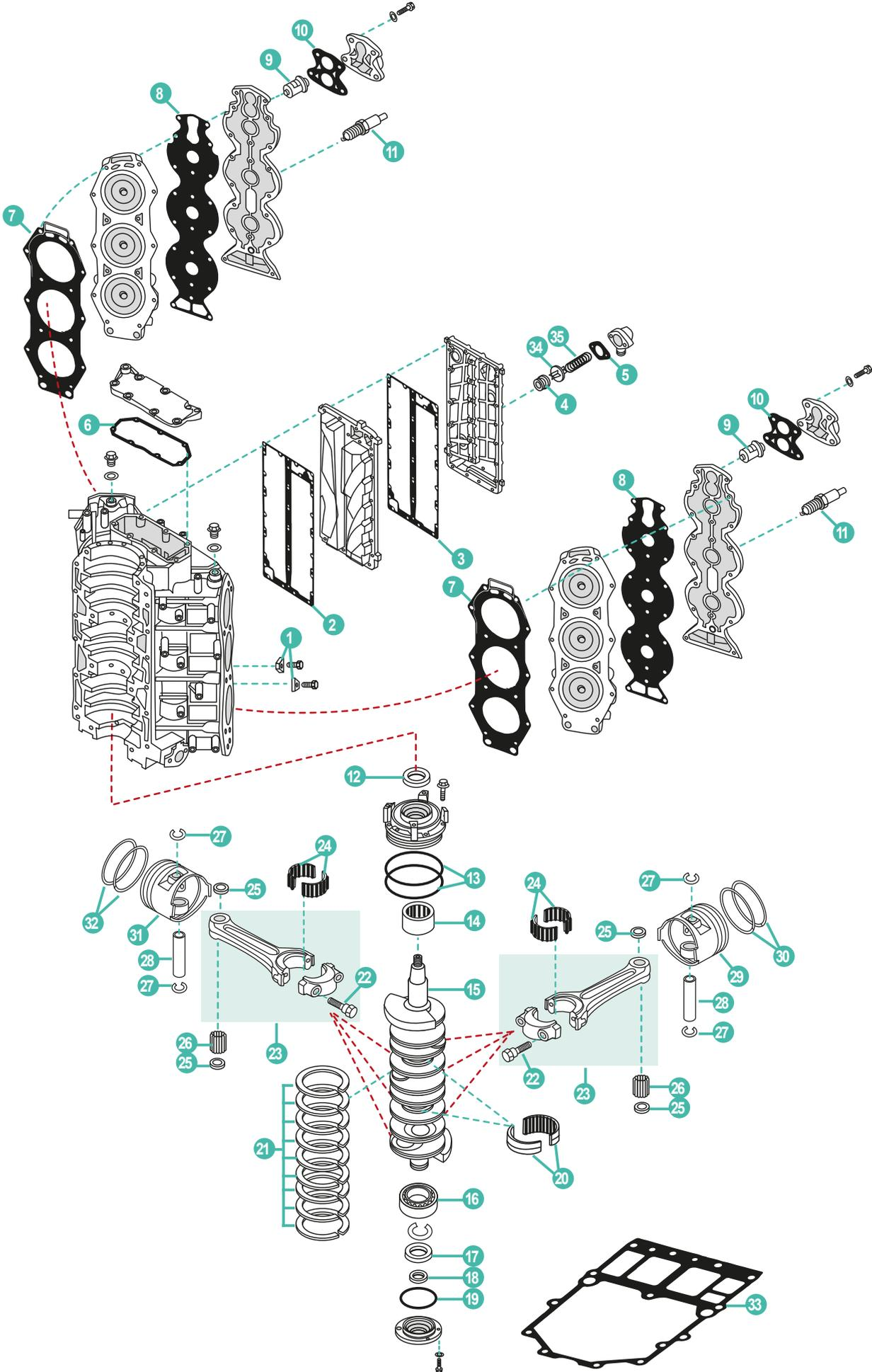

YAMAHA

RECAMBIOS  
MARINOS



	REF	OEM				UN.	
1	TEN01152	6E5-11325-00	ÁNODO	ANODE	ANODO	ANODE	8
2	REC6G5-41112-A1	6G5-41112-A1	JUNTA DE ESCAPE	EXHAUST GASKET	GUARNIZIONE DI SCARICO	JOINT D'ECHAPPEMENT	1
3	REC6G5-41114-A0	6G5-41114-A0	JUNTA EXTERIOR, TAPA DE ESCAPE	GASKET, EXHAUST OUTER COVER	GUARNIZIONE ESTERIORE, COPERCHIO SCARICO	JOINT DE COUVERCLE EXT ECHAPPEMENT	1
4	REC90480-20M05	90480-20M05	JUNTA DE GOMA	GROMMET	GUARNIZIONE GOMMA	JOINT	1
5	REC6G5-11382-A1	6G5-11382-A1	JUNTA	GASKET	GUARNIZIONE	JOINT	1
6	REC6E5-11381-A1	6E5-11381-A2	JUNTA	GASKET	GUARNIZIONE	JOINT	1
7	REC6G5-11181-A2	6G5-11181-A3	JUNTA CULATA	GASKET, CYLINDER HEAD	GUARNIZIONE TESTATA	JOINT DE CULASSE	2
8	REC6G5-11193-A0	6F5-11193-A0	JUNTA TAPA	GASKET, COVER	GUARNIZIONE COPERCHIO	JOINT DE COUVRE CULASSE	2
9	REC6E5-12411-30	6E5-12411-30	TERMOSTATO	THERMOSTAT	TERMOSTATO	THERMOSTAT	2
10	REC688-12414-A1	688-12414-A1	JUNTA TAPA TERMOSTATO	GASKET, THERMOSTAT COVER	GUARNIZIONE COPERCHIO TERMOSTATO	JOINT COUVERCLE DE THERMOSTAT	2
11	NGKBR8HS-10	94702-00271	BUJÍA	SPARK PLUG	CANDELA	BOUGIE	6
12	REC93102-40M14	93102-40M14	RETÉN DE ACEITE	OIL SEAL	PARAOLIO	JOINT SPI	1
13	REC93211-04001	93211-04001	TÓRICA	O-RING	O-RING	JOINT TORIQUE	2
14	REC93311-940U3	93311-940U3	RODAMIENTO	BEARING	CUSCINETTO	ROULEMENT À BILLE	1
	REC93311-940V0	93311-940V0	RODAMIENTO CIGÜEÑAL (6Do)	CRANKSHAFT BEARING (6Do)	CUSCINETTO ALBERO MOTORE (6Do)	ROULEMENT DE VILEBREQUIN (6Do)	1
15	REC6G5-11411-02	6G5-11411-02	CIGÜEÑAL	CRANKSHAFT	ALBERO MOTORE	VILEBREQUIN	1
16	REC93306-208U0	93306-208U0	RODAMIENTO	BEARING	CUSCINETTO	ROULEMENT	1
17	REC93102-35M13	93102-35M13	RETÉN DE ACEITE	OIL SEAL	PARAOLIO	JOINT SPI	1
18	REC93101-22M15	93101-22M15	RETÉN DE ACEITE	OIL SEAL	PARAOLIO	JOINT SPI	1
19	REC93210-74M35	93210-74M35	TÓRICA	O-RING	O-RING	JOINT TORIQUE	1
20	REC93310-954U1	93310-954U1	RODAMIENTO	BEARING	CUSCINETTO	ROULEMENT À BILLE	1
	REC93310-959U0	93310-959U0	RODAMIENTO CIGÜEÑAL (6Do)	CRANKSHAFT BEARING (6Do)	CUSCINETTO ALBERO MOTORE (6Do)	ROULEMENT DE VILEBREQUIN (6Do)	1
21	REC6E5-11447-00	6E5-11447-00	ARILLO	SEAL, CRANK	O-RING	JOINT	9
22	REC90109-08022	90109-08022	TORNILLO	BOLT	VITE	VIS	2
23	REC6R5-11650-10	6F5-11650-11	BIELA	CONNECTING ROD ASSY	BIELLA	BIELLE	6
24	REC93310-836V2	93310-836V2	COJINETE DE BIELA	BEARING, CONNECTING ROD	CUSCINETTO BIELLA	PALIER DE BIELLE	6
25	REC90201-23M01	90201-23M01	ARANDELA	WASHER PLATE	RONDELLA	RONDELLE	12
	REC90201-21M75	90201-21M75	ARANDELA (61A)	WASHER (61A)	RONDELLA (61A)	RONDELLE (61A)	12
26	REC93310-32337	93310-32337	AGUJA DE RODAMIENTO	BEARING NEEDLE	SPILLO DE CUSCINETTO	CLAVETTE DE PALIER	6
	REC93310-32668	93310-32668	AGUJA DE RODAMIENTO (250G)	BEARING NEEDLE (250G)	SPILLO DE CUSCINETTO (250G)	CLAVETTE DE PALIER (250G)	6
27	REC6R5-11634-00	6R5-11634-10	CIRCLIP	CIRCLIP	CIRCLIP	CIRCLIP	12
28	REC6R5-11633-00	6R5-11633-10	PIN, PISTÓN	PIN, PISTON	SPINOTTO PISTONE	AXE DE PISTON	6
29	REC64D-11642-00K	64D-11642-02-90	PISTON STD 2	PISTON STD 2	PISTONE STD 2	PISTON STD 2	3
	REC64D-11603-01	64D-11603-02	KIT SEGMENTOS DE PISTÓN STD	PISTON RING SET STD	KIT FASCE STD	KIT SEGMENTS STD	3
30	REC64D-11604-01	64D-11604-01	KIT SEGMENTOS DE PISTÓN 0.25mm O/S	PISTON RING SET 0.25mm O/S	KIT FASCE 0.25mm O/S	KIT SEGMENTS 0.25mm O/S	3
	REC64D-11605-01	64D-11605-02	KIT SEGMENTOS DE PISTÓN 0.50mm O/S	PISTON RING SET 0.50mm O/S	KIT FASCE 0.50mm O/S	KIT SEGMENTS 0.50mm O/S	3
31	REC64D-11631-00K	64D-11631-02-90	PISTON STD 1	PISTON STD 1	PISTONE STD 1	PISTON STD 1	3
	REC64D-11603-01	64D-11603-02	KIT SEGMENTOS DE PISTÓN STD	PISTON RING SET STD	KIT FASCE STD	KIT SEGMENTS STD	3
32	REC64D-11604-01	64D-11604-02	KIT SEGMENTOS DE PISTÓN 0.25mm O/S	PISTON RING SET 0.25mm O/S	KIT FASCE 0.25mm O/S	KIT SEGMENTS 0.25mm O/S	3
	REC64D-11605-01	64D-11605-02	KIT SEGMENTOS DE PISTÓN 0.50mm O/S	PISTON RING SET 0.50mm O/S	KIT FASCE 0.50mm O/S	KIT SEGMENTS 0.50mm O/S	3
33	REC6G5-45113-A1	6G5-45113-A1	JUNTA BASE MOTOR	GASKET ENGINE	GUARNIZIONE BASE MOTORE	JOINT DE TETE MOTRICE	1
34	REC60H-12416-00	60H-12416-00	VÁLVULA CONTROL DE PRESIÓN	VALVE, PRESSURE CONTROL	VALVOLA ANTIPRESSIONE	SOUPAPE DE DEPRESSION	1
35	REC90501-16M11	90501-16M11	MUELLE	SPRING COMPRESSION	MOLLA	RESSORT	1



JUNTAS DE MOTOR  
2 TIEMPOS

ENGINE GASKET  
2 STROKES

GUARNIZIONI  
MOTORE 2 TEMPI

JOINTS DE MOTEUR  
2 TEMPS

2T  
STROKES

JUNTAS DE CULATA

CYLINDER HEAD GASKET

GUARNIZIONE DE TESTATA

JOINT DE CULASSE

REF	OEM
REC6F8-11181-A0	6F8-11181-A1



2CMH (2003+)



REF	OEM
REC6H4-11181-00	6H4-11181-A2



25Q  
40N/H  
50E/D (1984-94)



REF	OEM
REC677-11181-A0	677-11181-A1



E8D/DMH (1997-03)



REF	OEM
REC61N-11181-00	61N-11181-A2



25VE/VM  
E25A/BMH  
30G  
E30HMH/H (1996-12)



REF	OEM
REC63V-11181-A1	63V-11181-A1



9.9F/MH/MSH  
E9.9D  
15F/FMH/MSH  
E15D  
13.5 AWH/AMH (1995+)



REF	OEM
REC689-11181-00	689-11181-A2



30A (1990-92)



REF	OEM
REC6E7-11181-00	6E7-11181-A2



9.9D  
15D (1988-96)



REF	OEM
REC6J8-11181-A2	6J8-11181-A2



30D  
25J (1986+)



REF	OEM
REC6L2-11181-A1	6L2-11181-A3



20D/M  
25D/M/N (1988+)



REF	OEM
REC6F5-11181-A2	6F5-11181-A2



40GWH/JWH  
E40GMH/JMH (2003)



REF	OEM
REC695-11181-00	695-11181-A1



20C  
25D (1986-02)



REF	OEM
REC63D-11181-A1	63D-11181-A2



40V  
C40/EL/TLR/Y  
50H/TLR/TR  
(1995+)



REF	OEM
REC6H3-11181-A0	6H3-11181-A2



25B  
50G  
60T  
E60  
60FE  
70B/ET/CE (1984+)



REF	OEM
REC6R7-11181-A0	6R7-11181-A1



40G (1993)



YAMAHA

RECAMBIOS  
MARINOS

REF	OEM
REC676-11181-01	676-11181-A2

40QE/QM/QWC (1990-98)

REF	OEM
REC6G5-11181-A2	6G5-11181-A3

150A/E/C/AET  
175AET/B/D  
200AET/B/C/FETGE  
225AET/BETO/D

REF	OEM
REC66T-11181-00	66T-11181-A0

40X  
E40X/M (1998-09)

REF	OEM
REC60V-11181-00	60V-11181-00

Z250  
VZ250  
LZ250 (2003-07)

REF	OEM
REC697-11181-A1	697-11181-A2

E55CMH  
E48CMH  
55BET  
55B/BE/BM (1990-05)

REF	OEM
REC68F-11181-00	68F-11181-00

Z/VZ/LZ200 (2001-07)  
Z/VZ/LZ150 (2000-07)  
Z/VZ175 (2001-07)

REF	OEM
REC688-11181-A1	688-11181-A2

75A/AE/CET  
80A/AE  
85A/AE  
90A/AE/TR (1986-14)

REF	OEM
REC6D0-11181-00	6D0-11181-00

VZ/LZ/Z300 (2004-07)

REF	OEM
REC6E5-11181-A0	6E5-11181-A2

100A  
115A/E/B/C  
C115T 130B  
140A (1984+)

REF	OEM
REC61A-11181-A0	69L-11181-00

225G/F (1194-03)  
250A/B/F (1992-06)

2T  
STROKES

**KITS**  
**JUNTAS DE CULATA**

**CYLINDER HEAD GASKET  
KIT**

REF	OEM
REC63V-W0001-00	63V-W0001-01

9.9-15F/FMH/FEMH/MSH (1995-00)  
13.5AWH (1998)

**KIT**  
**GUARNIZIONE TESTATA**

**KITS**  
**JOINT DE CULASSE**

REF	OEM
REC6E7-W0001-A1	6E7-W0001-00 6E7-W0001-A1

9.9D  
15D

REF	OEM
REC61T-W0001-02	61T-W0001-02

 E25A, 25VM, 30G/GE/A



REF	OEM
REC695-W0001-A2	695-W0001-01

 25D/DE (1985-92)  
20CM/C (1985-92)

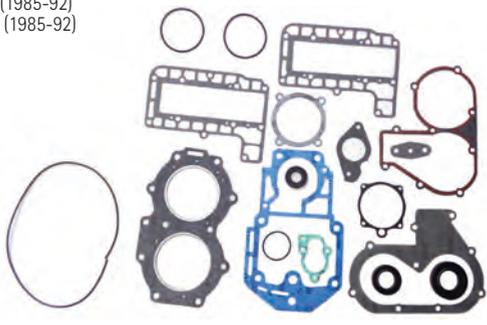

REF	OEM
REC6H3-W0001-02	6H3-W0001-02

 25B/BETO (1994-95)  
50G/GEO/GETOL (1994-98)  
60FEO/FETO/FEDO/TLR/FEHTO/TR (1994-2007)

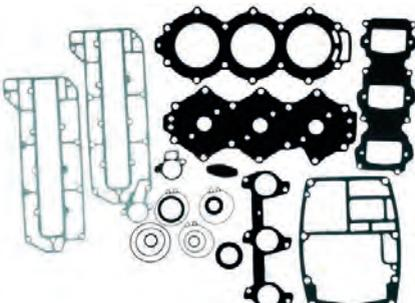

REF	OEM
REC6R6-W0001-02-00	6R6-W0001-02

 40QE-2 (1995-97)  
40QM (1996)  
40QWC (1998)

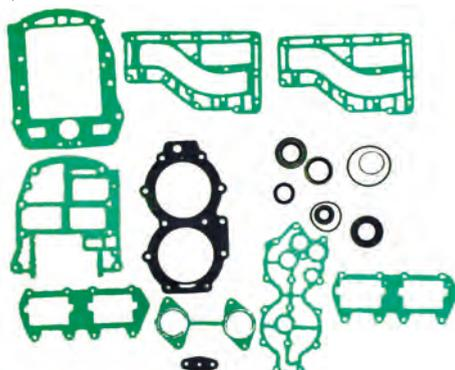

REF	OEM
REC6H4-W0001-04	6H4-W0001-04

 25QEO (1992-94)  
40HE (1992-94)  
50DE/DEMTO (1992-94)

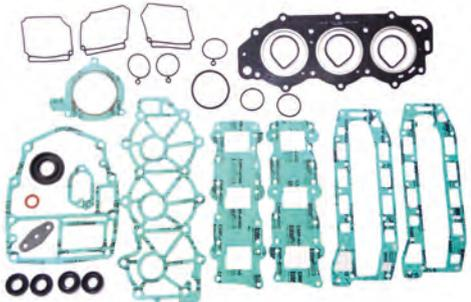

REF	OEM
REC66T-W0001-01	66T-W0001-01

 E40X/XMH/XW/  
MLHZ (2001-13)

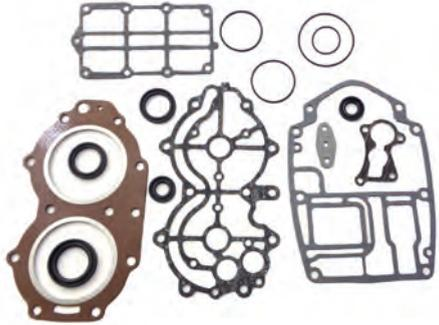

REF	OEM
REC6L2-W0001-03	6L2-W0001-A2

 25NE (1988-93)  
20DM (1988-93)  
25NEMO (1991-92)  
20D/DEO (1989-92)

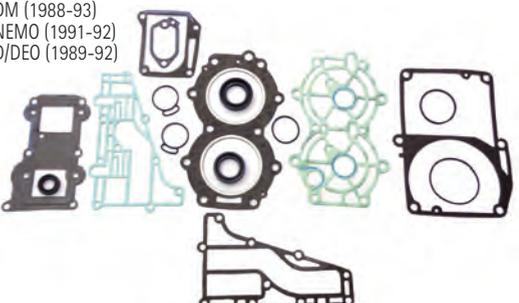

REF	OEM
REC6H4-W0001-A1	6H4-W0001-01

 40N (1984)  
40H (1985-98)  
50D (1985-98)  
50ETN (1984)

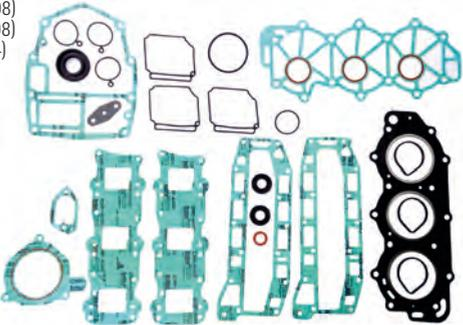

REF	OEM
REC6F6-W0001-02	6F6-W0001-02

**new**

 E40GMH/S/L  
 E40JMH  
 E40JWH  
 40GWH  
 40JWH

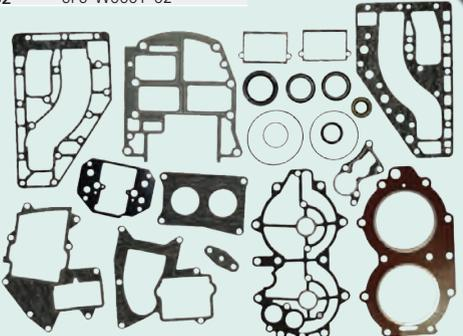

REF	OEM
REC688-W0001-A0	688-W0001-A0

 75A/AE (1990-91)  
 85A/AE (1990-91)

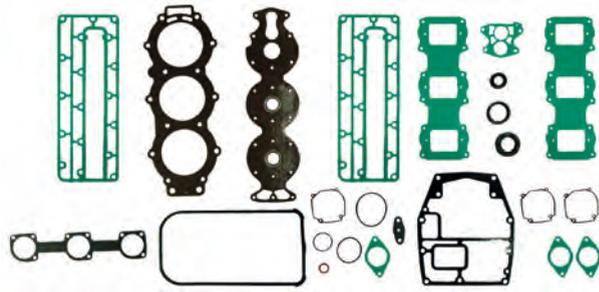

REF	OEM
REC63D-W0001-00	63D-W0001-00

 50H/HRDO/HMDH/HETO (1995-03)  
 40V/MMH/VETO/MLH/MHO/VE/VEO (1995-13)  
 40VEMHD/TLRZ/YETO (1997-07)  
 C40T/TLR (1995-02)

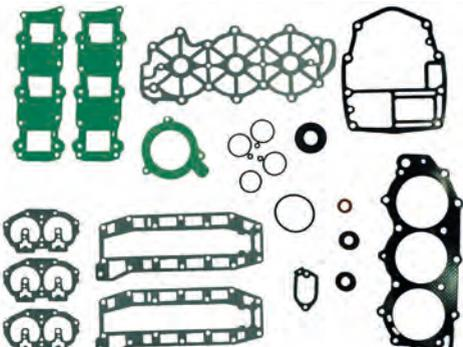

REF	OEM
REC6H1-W0001-00-00	6H1-W0001-A1

 80A/AE (1984-91)  
 80AEO (1992-93)  
 90A/AEO/AETO/ETN (1984-91)  
 90AEO (1992)

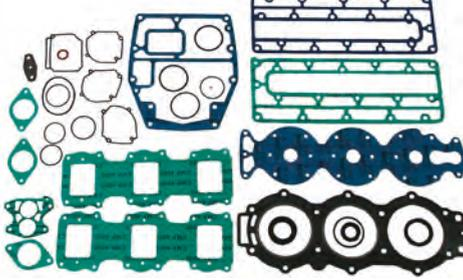

REF	OEM
REC697-W0001-02	697-W0001-A0

 55BET (1990)

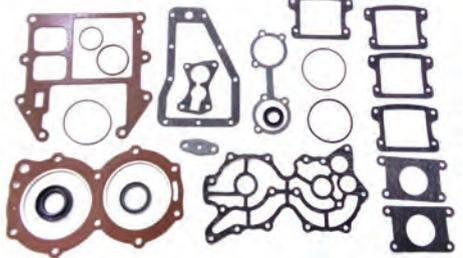

REF	OEM
REC6E5-W0001-A2	6E5-W0001-A2

 L130BETO (1991-99)  
 115CEO/CETO (1991-96)  
 100A/AETO/TLR (1996-00)

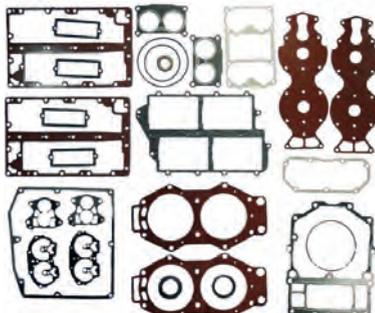

REF	OEM
REC6K5-W0001-02	6K5-W0001-02

 E60H/MHZ/HE/HM (1996-02)



REF	OEM
REC6F3-W0001-04-00	6F3-W0001-A4

 115BETO (1991-93)  
 115B (1988-00)  
 115ETN (1984)  
 115A (1987)  
 140AETO/BETO (1984-89)  
 115BE (1992)

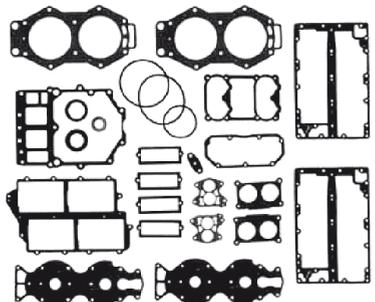

REF	OEM
REC6R3-W0001-03	6R3-W0001-A3

 L/150 CETO (1990-95)  
 L/200 BETO (1993-95)  
 175BETO/ET (1990-95)  
 L200ETD (1990)  
 150CED/ETD (1990)  
 200ET (1990)



REF	OEM
REC61A-W0001-01	61A-W0001-A1

 250ETD (1990)  
 250AETO/AET/B (1990-96)  
 L250A/AET/AETO (1992-96)  
 225C (1994-95)  
 L225CETO (1994)

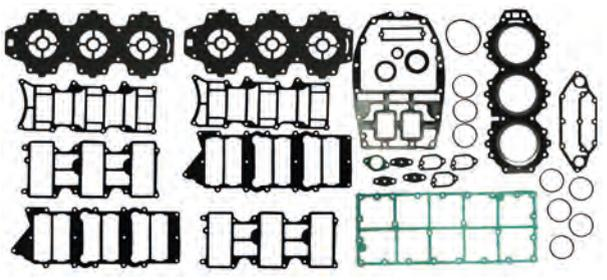

REF	OEM
REC68F-W0001-01	68F-W0001-01

 LZ200 (2004-10)  
 VZ200 (2004)  
 Z200 (2004-10)  
 Z  
 VZ200TLRC/PETO/TLR2D/PETOL/TXRC/  
 NETO-L/TR/NETOX/Z175GETO/GETOX/TR/TXR (2004-07)

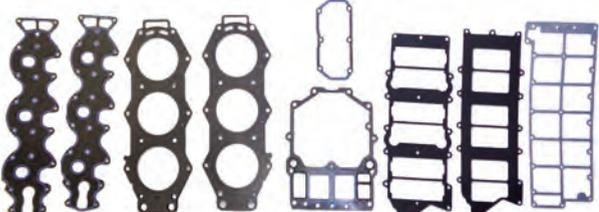

REF	OEM
REC6D0-W0001-00	6D0-W0001-00

 Z300AETO/TR  
 LZ300AETO/TR (2004-07)

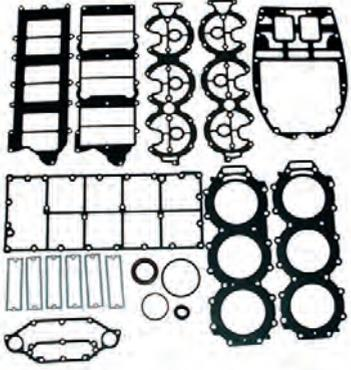

REF	OEM
REC6G5-W0001-A3	6G5-W0001-03

 200CETO (1992-93)  
 PROV200 (1991-94)  
 225BET/BETO (1991-95)  
 150A/AETO/AETL/AETX (1998-02)



2T STROKES    JUNTAS BASE DE MOTOR    CYLINDER GASKET    GUARNIZIONE BASE MOTORE    JOINTS DE TETE MOTRICE

REF	OEM
REC6E0-45113-A1	6E0-45113-A1

 4A/AC/AS/MSH  
 5C/CS/CMH

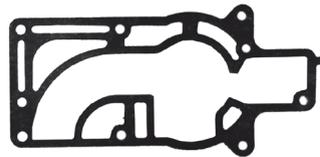

REF	OEM
REC6G1-45113-A1	6G1-45113-A1

 8N/C/J/T/M  
 6C/J/D/T/M



REF	OEM
REC677-45113-A0	677-45113-A0

 E8D/DMH



REF	OEM
REC6B4-11351-A1	6B4-11351-A1

 9.9/15 HP D 6B3-6B4 (2003)

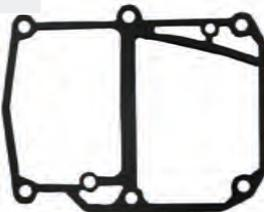

new

REF	OEM
REC63V-45113-A1	63V-45113-A1
	9.9FEM/F/MSH/FMH/MH 13.5 AW/AMH 15F/FEM/MSH/FMH/MH
	

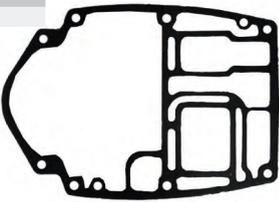
REF	OEM
REC66T-45113-A0	66T-45113-A0
	40X/E40X
	

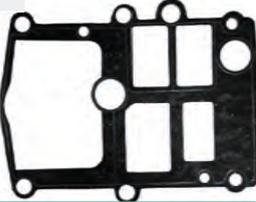
REF	OEM
REC682-11351-A0	682-11351-A0
	9.9D 15D
	

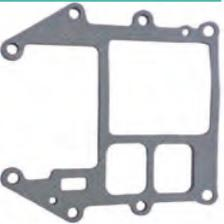
REF	OEM
REC696-45113-00	696-45113-A0
	55B/E55 E48
	

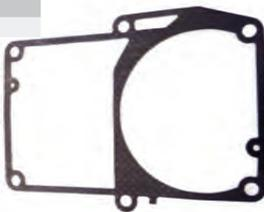
REF	OEM
REC6L2-45113-A2	6L2-45113-A1
	20D 25D/N/M
	

REF	OEM
REC6H3-45113-00	6H3-45113-A0
	60FE/TLR/F, 50G/GE E60H 70B/BE/CE/TR
	

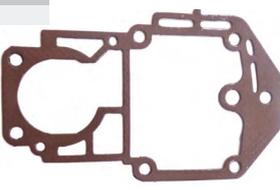
REF	OEM
REC61T-45113-A0	61T-45113-A0
	25VE/BMH 30G/HW
	

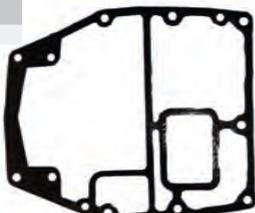
REF	OEM
REC688-45113-A0	688-45113-A0
	75A/AE/CE/TL 85A/AE 80A/AE 90A/AE/ETN
	

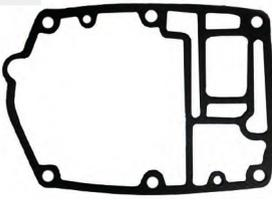
REF	OEM
REC6J8-45113-00	6J8-45113-A0
	25J 30D/DMH/DE/E/M
	

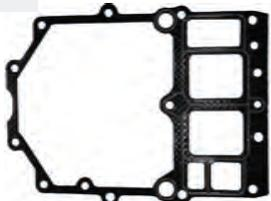
REF	OEM
REC6G5-45113-A1	6G5-45113-A2
	115ETN/A/B 130BE 150ETN/AET/CET/F/TXR/G 140AET/BET 175AET/BET/DE 150BET 200ETN/AET/CET/BET/AF/G 220AET 225AET/BET/D
	

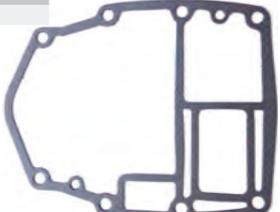
REF	OEM
REC6H4-45113-00	6H4-45113-A0
	25Q 40N/H/E/M/T/Y 50D/H/T
	

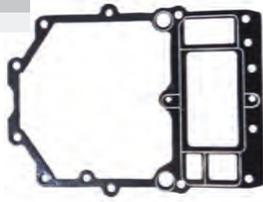
REF	OEM
REC6E5-45113-A2	6E5-45113-A0
	115B/ET 140AE/BE
	

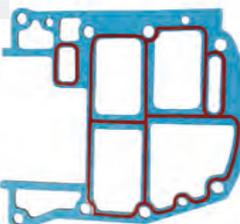
REF	OEM
REC6F5-45113-A0	6F5-45113-A0
	E40G/E40J/40G/40J/40Q
	

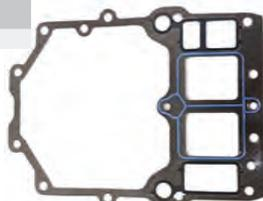
REF	OEM
REC68F-45113-01	68F-45113-01
	Z/VZ150 Z/VZ175 VZ-Z200/200A/F/J 150F/A Z200
	

2T  
STROKES

REF	OEM
REC60V-45113-02	60V-45113-02



LZ/Z/NZ  
250D/T/F  
300A/B/T (2004-07)

REF	OEM
REC61A-45113-A0	61A-45113-A0

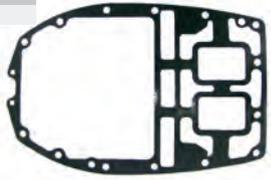

Z/NZ250  
Z300

GUÍA JUNTAS DE MOTOR		ENGINE GASKET GUIDE	GUIDA GUARNIZIONE MOTORE	GUIDE JOINTS DE MOTEURS
STROKE	CYL	JUNTA CULATA CYLINDER HEAD GASKET GUARNIZIONE TESTAT JOINT DE CULASSE		KIT JOINTS
				JUNTA BASE MOTOR CYLINDER GASKET GUARNIZIONE BASE MOTORE JOINT DE TETE MOTRICE
2CMH	2010	1	REC6F8-11181-A0	REC646-14623-A1
E8D/DMH	1997-03	2	REC677-11181-A0	REC677-45113-A0
9.9D	1988-96	2	REC6E7-11181-00	REC682-45113-A0
9.9F/FM/MSH/E9.9D	1995	2	REC63V-11181-A1	REC63V-45113-A1
13.5AWH/AMH	1995	2	REC63V-11181-A1	REC63V-45113-A1
15D	1988-95	2	REC6E7-11181-00	REC682-45113-A0
15F/FMH/MSH/E15D	1995	2	REC63V-11181-A1	REC63V-45113-A1
20C	1986-02	2	REC695-11181-00	REC61T-45113-A0
20D/20DM	1988	2	REC6L2-11181-A1	REC6L2-45113-A2
25DE/M/N	1998	2	REC6L2-11181-A1	REC6L2-45113-A2
25DE/M/N	1986-02	2	REC695-11181-00	REC61T-45113-A0
25VE/VM/BMH/E25A	1996-12	2	REC61N-11181-00	REC61T-45113-A0
25Q/QEO	1990-94	3	REC6H4-11181-00	REC6H4-45113-00
25J/JEO/JETO	1987-99	3	REC6J8-11181-A2	REC6J8-45113-00
25B/BETO	1994-95	3	REC6H3-11181-A0	REC6H3-45113-00
25B/BMH	1996-10	2	REC61N-11181-00	REC61T-45113-A0
30A	1990-92	2	REC689-11181-00	REC61T-45113-A0
30G/E30HMH/H	1996-12	2	REC61N-11181-00	REC61T-45113-A0
30D	1986	3	REC6J8-11181-A2	REC6J8-45113-00
40QE/QM/QWC	1990-98	2	REC676-11181-01	REC6R6-45113-A0
40N/H	1984-94	3	REC6H4-11181-00	REC6H4-45113-00
40G	1993	2	REC6R7-11181-A0	REC6R6-45113-A0
40X/E40/M/X	1998	2	REC66T-11181-00	REC66T-45113-A0
40/E40GMH/JMH	2003	2	REC6F5-11181-A2	REC6F5-45113-A0
40V/C40/EL/TLR/Y-YE	1995	3	REC63D-11181-A1	REC6H4-45113-00
E48	2003	2	REC697-11181-A1	REC696-45113-00
50H/TLR/TR	1995	3	REC63D-11181-A1	REC6H4-45113-00
50G/GEO/GETO	1993-02	3	REC6H3-11181-A0	REC6H3-45113-00
50E/D	1984-94	3	REC6H4-11181-00	REC6H4-45113-00
55B/E55	1990-05	2	REC697-11181-A1	REC697-45114-00
60FE/T/E60	1984	3	REC6H3-11181-A0	REC6H3-45113-00
70B/ET/CE	1984	3	REC6H3-11181-A0	REC6H3-45113-00
70A/AE/CET	1986	3	REC688-11181-A1	REC688-45113-A0
80A/AE	1986	3	REC688-11181-A1	REC688-45113-A0
85A/AE	1986	3	REC688-11181-A1	REC688-45113-A0
90A/AE/TR	1986	3	REC688-11181-A1	REC688-45113-A0
100A	1984	4	REC6E5-11181-A0	REC6E5-45113-A2
115A/B/E/C/C115T	1984	4	REC6E5-11181-A0	REC6E5-45113-A2
130B	1984	4	REC6E5-11181-A0	REC6E5-45113-A2
140A	1984	4	REC6E5-11181-A0	REC6E5-45113-A2
LZ150/NZ150/Z150	2004-05	6	REC68F-11181-00	REC68F-45113-01
150A/E/C/FET	1984-10	6	REC6G5-11181-A2	REC6G5-45113-A1
VZ175/Z175	2004-10	6	REC68F-11181-00	REC68F-45113-01
175D/B/AET	1984-10	6	REC6G5-11181-A2	REC6G5-45113-A1
LZ200/NZ200/Z200	2004-10	6	REC68F-11181-00	REC68F-45113-01
200B/C/AET/GE/FET	1984	6	REC6G5-11181-A2	REC6G5-45113-A1
225D/BET/AET	1984	6	REC6G5-11181-A2	REC6G5-45113-A1
225C/G	1990	6	REC61A-11181-A0	REC61A-45113-A0
250A/E/B	1990-06	6	REC61A-11181-A0	REC61A-45113-A0
Z-LZ250DET/TUR/TR	2003-07	6	REC60V-11181-00	REC60V-45113-02
250TR/FET/HETO	2003-07	6	REC60V-11181-00	REC60V-45113-02
V250TLR/TR	2003	6	REC60V-11181-00	REC60V-45113-02
Z-LZ300	2004-07	6	REC6D0-11181-00	REC6D0-45113-02



JUNTAS DE CULATÍN

GASKET, HEAD COVER

GUARNIZIONI COPERCHIO  
TESTATA

JOINT DE COUVRE CULASSE

REF	OEM
REC6L2-11193-A1	6L2-11193-A1
	20D/DM/DEO 25NE/NEMO/NWC/ MSH

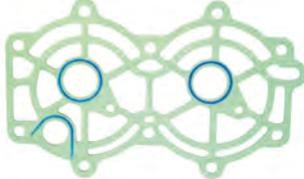

REF	OEM
REC63D-11193-A0	63D-11193-A0
	50H/T (1995+) 40V/M/Y (1995+)

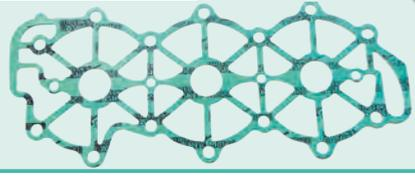

**new**

REF	OEM
REC6H3-11193-A1	6H3-11193-A1
	25B/BETO 50G/GEO/GETO 60FEO/FETO/FEDO/TLR E60H/ HMH/MLH 70B//BEO/BEMO/BETO/TR



REF	OEM
REC688-11193-A1	688-11193-A1
	75CETO/TLR/AE E75B 80AEO/AETO/A 85A/AE 90AEO/TLR/A/AETO



REF	OEM
REC61T-11193-A0	61T-11193-A1
	25VE/VM/BMH/B E25A/BMH 30G/GE/HMH/HW MSH

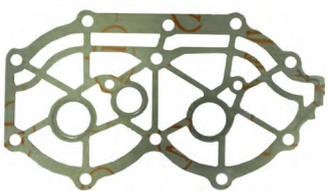

REF	OEM
REC6E5-11193-A0	6E5-11193-A0
	100A/AETO/TLR 115B/BETO/BE C115TLR/CEO/CETO/TXR E115AEL 130BETO



REF	OEM
REC66T-11193-A0	66T-11193-A0
	40X/E40X E40 MLH/X/XW

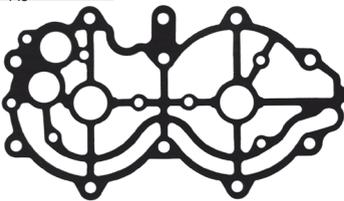

REF	OEM
REC68F-11193-02	68F-11193-02
	Z150P/TXR/PETO/TR/Q/QETO Z175G/GETO/TR/TXR/H Z200N/TXR/PETO/TLR/NETO



REF	OEM
REC6E9-11193-A0	6E9-11193-A0
	40QE/QE-Z/QM/QWC

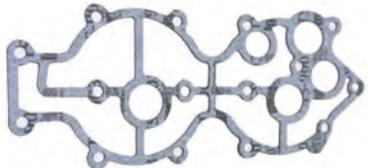

REF	OEM
REC6G5-11193-A0	6G5-11193-A1
	150A/AET/CETO/F/FETO/TXR D150H 175D/DETO/BETO 200AET/CETO/FETO/G/GETO/BETO/TXR/F/TLR, 225D/DET/BET



REF	OEM
REC6F6-11193-A1	6F6-11193-A1
	40GWH/JWH E40GMH/JMH

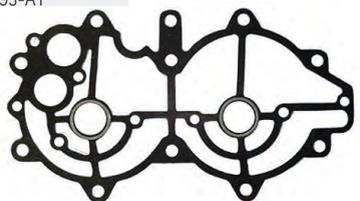

REF	OEM
REC61A-11193-A2	61A-11193-A2
	225C/CETO/G/GETO 250AET/B/TXR



REF	OEM
REC663-11193-00	663-11193-A0
	E48CMH 55BET/B/BE/BM/BET E55CMH

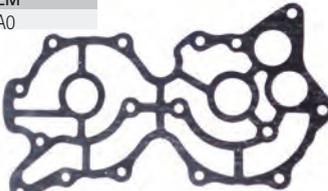

REF	OEM
REC6H4-11193-A1	6H4-11193-00
	25Q (1990-94) 40N/H (1984-91) 50E/D (1984-94)

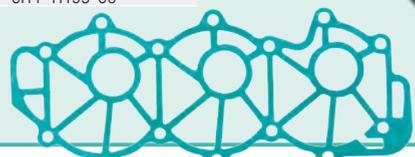

**new**

CIGÜEÑAL

CRANKSHAFT

ALBERO MOTORE

VILEBREQUIN

2T STROKES GUÍA CIGÜEÑAL COMPLETO			GUIDE CRANKSHAFT ASSY			GUIDA ALBERO MOTORE COMPLETO			GUIDE VILEBREQUIN COMPLET		
2T STROKES		REF	2T STROKES		REF	2T STROKES		REF	2T STROKES		REF
E48CMHS	2003	REC663-11411-00	140A	1984-87	REC6E5-11411-00	175D ETO	2000	REC6G5-11411-02			
E55CMH/L/S	2003-05	REC663-11411-00	140B	1988-89	REC6E5-11411-00	175D ETOX	2001-02	REC6G5-11411-02			
55B	1993-02	REC663-11411-00	L140B	1989	REC6E5-11411-00	200A	1984-89	REC6G5-11411-02			
55B E	1990-92	REC663-11411-00	150A	1984-89	REC6G5-11411-02	200AET-L-X	2003	REC6G5-11411-02			
55B EHD	2000	REC663-11411-00	150A ET	1998-00	REC6G5-11411-02	200BETO/ETD	1990-95	REC6R3-11411-00			
55B ET	1990-98	REC663-11411-00	150A ETL/ETX	2001	REC6G5-11411-02	200CETO	1992-93	REC6R3-11411-00			
55B ETL	2001-02	REC663-11411-00	150D ETOL	2001-03	REC6G5-11411-02	200F	1997-98	REC6G5-11411-02			
80A/90AETO	1988	REC688-11411-00	150F	1997-98	REC6G5-11411-02	200F ETO	2000	REC6G5-11411-02			
100A	1996-01	REC6N7-11411-00	150F ETO	2000	REC6G5-11411-02	200F ETOL	2001	REC6G5-11411-02			
100A A ETO	2000	REC6N7-11411-00	150FETOL-X	2002-07	REC6G5-11411-02	200FETOL-X	2002-10	REC6G5-11411-02			
100A ETOL	2001	REC6N7-11411-00	150F ETOL	2001-06	REC6G5-11411-02	200F ETOX	2001	REC6G5-11411-02			
115A	1984-87	REC6E5-11411-00	150F ETOX	2001-06	REC6G5-11411-02	200G	1999	REC6G5-11411-02			
115B	1985-01	REC6E5-11411-00	D150H	1999	REC6G5-11411-02	200G ETO	2000	REC6G5-11411-02			
115B ETO	1997-00	REC6N7-11411-00	DX150TLRA	2002	REC67H-11411-00	200G ETOL	2001	REC6G5-11411-02			
115B ETOL	2001-02	REC6N7-11411-00	L150A	1988-89	REC6G5-11411-02	L200A	1988-91	REC6G5-11411-02			
115CEO	1990-98	REC6N7-11411-00	L150CETO	1990-95	REC6R3-11411-00	L200BETO/ET	1990-95	REC6R3-11411-00			
115C ETO	1995-01	REC6N7-11411-00	L150F	1997-98	REC6G5-11411-02	L200F	1997-98	REC6G5-11411-02			
115CETOL/CETOX	2001	REC6N7-11411-00	L150F ETO	2000	REC6G5-11411-02	L200F ETO	2000	REC6G5-11411-02			
130BETO	1990-01	REC6N7-11411-00	L150 FETOL/FETOX	2001	REC6G5-11411-02	PROV200	1991-95	REC6R3-11411-00			
130BETOL/BETOX	2001	REC6N7-11411-00	SX150TXRA	2002	REC67H-11411-00	220AET	1984-96	REC6G5-11411-02			
L130B	1991-98	REC6N7-11411-00	175A	1984-89	REC6G5-11411-02	225AETO	1987-89	REC6G5-11411-02			
L130B ETO	2000	REC6N7-11411-00	175BETO/ET	1990-95	REC6R3-11411-00	225D-DET	1997-01	REC6G5-11411-02			
L130B ETOX	2001	REC6N7-11411-00	175D	1997-98	REC6G5-11411-02						

2T STROKES GUÍA PARTES DE CIGÜEÑAL		GUIDE CRANKSHAFT PARTS		GUIDA PARTE ALBERO MOTORE		GUIDE PARTS DE VILEBREQUIN	
		1	2	3	4		
6B/8B	1980-81	REC677-11412-02	REC677-11422-02	REC677-11432-02	REC677-11442-02		1
E8D	1996-99	REC677-11412-02	REC677-11422-02	REC677-11432-02	REC677-11442-02		
E8D MH	1998-99	REC677-11412-02	REC677-11422-02	REC677-11432-02	REC677-11442-02		
9.9D	1985-97	REC682-11412-00	REC682-11422-00	REC682-11432-00	REC682-11442-00		
9.9D	1988-95	REC63V-11412-00	REC6K4-11422-00	REC6K4-11432-00	REC682-11442-00		2
9.9F/MH	1995-14	REC63V-11412-00	REC63V-11422-00	REC63V-11432-00	REC63V-11442-00		
9.9F WH	2000	REC63V-11412-00	REC63V-11422-00	REC63V-11432-00	REC63V-11442-00		
9.9F WHL/S	2001	REC63V-11412-00	REC63V-11422-00	REC63V-11432-00	REC63V-11442-00		
13.5A	1999-06	REC63V-11412-00	REC63V-11422-00	REC63V-11432-00	REC63V-11442-00		3
15D	1985-87	REC682-11412-00	REC682-11422-00	REC63V-11432-00	REC682-11442-00		
15D	1988-95	REC682-11412-00	REC6K4-11422-00	REC6K4-11432-00	REC682-11442-00		
15F/MH	1995-14	REC63V-11412-00	REC63V-11412-00	REC63V-11432-00	REC63V-11442-00		
E15D	2003	REC63V-11412-00	REC63V-11422-00	REC63V-11432-00	REC63V-11442-00		4
15F WCL	2001-03	REC63V-11412-00	REC63V-11422-00	REC63V-11432-00	REC63V-11442-00		
15 WCS	2001-02	REC63V-11412-00	REC63V-11422-00	REC63V-11432-00	REC63V-11442-00		
20C	1981-86	REC6G0-11412-00	REC6G0-11422-00	REC6G0-11432-00			
20C	1996-02		REC6G0-11422-00	REC6G0-11432-00			
20C M	1990-02	REC6G0-11412-00	REC6G0-11422-00	REC6G0-11432-00			
25D	1985-87	REC6G0-11412-00	REC6G0-11422-00	REC6G0-11432-00			
25D M	1990-97	REC6G0-11412-00	REC6G0-11422-00	REC6G0-11432-00	REC6G0-11442-00		
25D MH	1998	REC6G0-11412-00	REC6G0-11422-00	REC6G0-11432-00	REC6G0-11442-00		
25D MHL/MHS	2001	REC6G0-11412-00	REC6G0-11422-00	REC6G0-11432-00	REC6G0-11442-00		
40X/E40X/MH	1998-02	REC66T-11412-00	REC66T-11422-00	REC66T-11432-00	REC66T-11442-00		
40X MHL	2001-13	REC66T-11412-00	REC66T-11422-00	REC66T-11432-00	REC66T-11442-00		
40X MHS	2001-13	REC66T-11412-00	REC66T-11422-00	REC66T-11432-00	REC66T-11442-00		
40X W	2000	REC66T-11412-00	REC66T-11422-00	REC66T-11432-00	REC66T-11442-00		
40X WL/WS	2001-03	REC66T-11412-00	REC66T-11422-00	REC66T-11432-00	REC66T-11442-00		
40X WT	2000	REC66T-11412-00	REC66T-11422-00	REC66T-11432-00	REC66T-11442-00		
40X WTL	2001-03	REC66T-11412-00	REC66T-11422-00	REC66T-11432-00	REC66T-11442-00		

GUÍA  
RODAMIENTOS DE MOTOR

GUIDE  
ENGINE BEARING

GUIDA  
CUSCINETTI MOTORE

GUIDE  
ROULEMENTS DE MOTEUR

		1	2	3	4	5
4A	1985-87	REC93306-304U0		REC93306-304U0	REC93310-112V0	REC93310-418V1
4AC	1987-99	REC93306-304U0		REC93306-304U0	REC93310-112V0	REC93310-418V1
4AC	1999	REC93306-304U0		REC93306-304U0	REC93310-112V0	REC93310-418V1
4AC MHL/MHS	2001-03	REC93306-304U0		REC93306-304U0	REC93310-112V0	REC93310-418V1
4AS	1987-96	REC93306-304U0		REC93306-304U0	REC93310-112V0	REC93310-418V1
4BC	1998-99	REC93306-304U0		REC93306-304U0	REC93310-112V0	REC93310-418V1
4BC	1999	REC93306-304U0		REC93306-304U0	REC93310-112V0	REC93310-418V1
4BC MHL/MHS	2001-03	REC93306-304U0		REC93306-304U0	REC93310-112V0	REC93310-418V1
5C	1985-99	REC93306-304U0		REC93306-304U0	REC93310-112V0	REC93310-418V1
5C MHL/MHS	2001-13	REC93306-304U0		REC93306-304U0	REC93310-112V0	REC93310-418V1
5CS	1987-96	REC93306-304U0		REC93306-304U0	REC93310-112V0	REC93310-418V1
6C	1990	REC93306-204U0	REC93306-204U0	REC93306-204U0	REC93310-112V0	REC93310-418V1
6C	1990-02	REC93306-204U0	REC93306-204U0	REC93306-204U0	REC93310-112V0	REC93310-418V1
6C MHL/MHS	2001-06	REC93306-204U0	REC93306-204U0	REC93306-204U0	REC93310-112V0	REC93310-418V1
6C WHL/WHS	2001	REC93306-204U0	REC93306-204U0	REC93306-204U0	REC93310-112V0	REC93310-418V1
6C	1990	REC93306-204U0	REC93306-204U0	REC93306-204U0	REC93310-112V0	REC93310-418V1
6D	1990-98	REC93306-204U0	REC93306-204U0	REC93306-204U0	REC93310-112V0	REC93310-418V1
6D MHL/MHS	2001-06	REC93306-204U0	REC93306-204U0	REC93306-204U0	REC93310-112V0	REC93310-418V1
6D WHS	2001	REC93306-204U0	REC93306-204U0	REC93306-204U0	REC93310-112V0	REC93310-418V1
8C	1987-02	REC93306-204U0	REC93306-204U0	REC93306-204U0	REC93310-112V0	REC93310-418V1
8C MHL/MHS	2001-12	REC93306-204U0	REC93306-204U0	REC93306-204U0	REC93310-112V0	REC93310-418V1
8C MHX/WHL	2001-03	REC93306-204U0	REC93306-204U0	REC93306-204U0	REC93310-112V0	REC93310-418V1
E8D/MH	1996-99	REC93306-204U0	REC93306-204U0	REC93306-204U0	REC93302-14118	REC93310-418U0
9.9D	1985-89	REC93306-205U2	REC93304-205U0	REC93306-304U0	REC93602-14104	REC93310-620V5
9.9D	1985-95	REC93306-205U2	REC93304-205U0	REC93306-304U0	REC93602-14104	REC93310-620V5
9.9D	1990-95	REC93306-205U2	REC93304-205U0	REC93306-304U0	REC93602-14104	REC93310-620V5
9.9F	1995-99	REC93306-205U7	REC93306-205U7	REC93306-205U7	REC93602-14104	REC93310-620V5
9.9F MH	2000	REC93306-205U7	REC93306-205U7	REC93306-205U7	REC93602-14104	REC93310-620V5
9.9F MHL/MHS	2001-06	REC93306-205U7	REC93306-205U7	REC93306-205U7	REC93602-14104	REC93310-620V5
9.9F WC/WH	2000	REC93306-205U7	REC93306-205U7	REC93306-205U7	REC93602-14104	REC93310-620V5
9.9F WHL/WHS	2001	REC93306-205U7	REC93306-205U7	REC93306-205U7	REC93602-14104	REC93310-620V5
13.5A	1999	REC93306-205U7	REC93306-205U7	REC93306-205U7	REC93602-14104	REC93310-620V5
13.5A MH	2000	REC93306-205U7	REC93306-205U7	REC93306-205U7	REC93602-14104	REC93310-620V5
13.5A MHL/MHS	2001-04	REC93306-205U7	REC93306-205U7	REC93306-205U7	REC93602-14104	REC93310-620V5
13.5A WH	2000	REC93306-205U7	REC93306-205U7	REC93306-205U7	REC93602-14104	REC93310-620V5
15D	1985-89	REC93306-205U2	REC93304-205U0	REC93306-304U0	REC93602-14104	REC93310-620V5
15D	1985	REC93306-205U2	REC93304-205U0	REC93306-304U0	REC93602-14104	REC93310-620V5
15D	1990-95	REC93306-205U2	REC93304-205U0	REC93306-304U0	REC93602-14104	REC93310-620V5
15F	1995-99	REC93306-205U7	REC93306-205U7	REC93306-205U7	REC93602-14104	REC93310-620V5
15F MH	2000	REC93306-205U7	REC93306-205U7	REC93306-205U7	REC93602-14104	REC93310-620V5
15F MHL/MHS	2001-06	REC93306-205U7	REC93306-205U7	REC93306-205U7	REC93602-14104	REC93310-620V5
15F WC	2000	REC93306-205U7	REC93306-205U7	REC93306-205U7	REC93602-14104	REC93310-620V5
15F WCL/WCS	2001-03	REC93306-205U7	REC93306-205U7	REC93306-205U7	REC93602-14104	REC93310-620V5
20C	1985	REC93306-305I0		REC93306-305I0	REC93602-20M02	REC93310-522W0
20C	1986-93	REC93306-305I0		REC93306-305I0	REC93602-20M02	REC93310-522W0
20C	1993	REC93306-305U3		REC93306-305U3	REC93602-20M02	REC93310-522W0
20C M	1990-97	REC93306-305U3		REC93306-305U3	REC93602-20M02	REC93310-522W0
20C MH	1998	REC93306-305U3		REC93306-305U3	REC93602-20M02	REC93310-522W0
20C MHL/MHS	2001-02	REC93306-305U3		REC93306-305U3	REC93602-20M02	REC93310-522W0
20DEM	1994-98	REC93311-632U7	REC93306-305U3	REC93306-305U3		
20D MHOL/MHOS	2001-06	REC93311-632U7	REC93306-305U3	REC93306-305U3		
20D WOL/WOS	2006	REC93311-632U7	REC93306-305U3	REC93306-305U3		
25B	1994-95	REC93311-636U6		REC93306-306V1	REC93603-18M09	REC93603-18M09
25B MHL/MHS	2001-06	REC93399-99951		REC93306-305U3	REC93602-20M02	
25B WCS	2001-02	REC93399-99951		REC93306-305U3	REC93602-20M02	
25D	1985	REC93306-305I0		REC93306-305I0	REC93602-20M02	REC93310-522W0
25D	1986-87	REC93306-305I0		REC93306-305I0	REC93602-20M02	REC93310-522W0
25D M	1990-97	REC93311-632U7	REC93306-305U3	REC93306-305U3	REC93602-20M02	REC93310-522W0
25D MH	1998	REC93311-632U7	REC93306-305U3	REC93306-305U3	REC93602-20M02	REC93310-522W0
25D MHL/MHS	2001	REC93311-632U7	REC93306-305U3	REC93306-305U3	REC93602-20M02	REC93310-522W0
25J	1987-2000			REC93306-305U3		
25J	1992-2000	REC93311-632U7		REC93306-305U3		
25N	1994-98	REC93311-632U7	REC93306-305U3	REC93306-305U3		
25N MHOL/MHOS	2001-06	REC93311-632U7	REC93306-305U3	REC93306-305U3		
25N WOL/WOS	2001-03	REC93311-632U7	REC93306-305U3	REC93306-305U3		
25V	1996	REC93311-632U7	REC93306-305U3	REC93306-305U3	REC93602-20M02	
25V	1997-98	REC93311-632V4	REC93306-305U3	REC93306-305U3	REC93602-20M02	REC93310-624U5
25V MHL/MHS	2001	REC93311-632V4	REC93306-305U3	REC93306-305U3	REC93602-20M02	REC93310-624U5
25V WCS	2001	REC93311-632V4	REC93306-305U3	REC93306-305U3	REC93602-20M02	REC93310-624U5
30A	1985			REC93306-305I0	REC93602-20M02	REC93310-624U5
30A M	1990-92			REC93306-305U3	REC93602-20M02	REC93310-624U5
30D	1986-99			REC93306-305U3		
30D	1992-00	REC93311-632U7		REC93306-305U3		
30D EOL/ETOL	2001-06	REC93311-632U7		REC93306-305U3		
30D MHOL/MHOS	2001-06	REC93311-632U7		REC93306-305U3		
30D OL	2001-03	REC93311-632U7		REC93306-305U3		
30D EOS	2001-06	REC93311-632U7		REC93306-305U3		
30G	1996	REC93311-632U7		REC93306-305U3	REC93602-20M02	REC93310-624U5

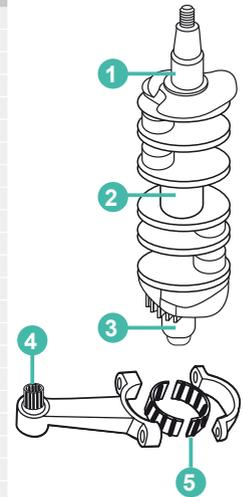



1 2 3 4 5

30G	1996-98	REC93311-632V4		REC93306-305U3	REC93602-20M02	REC93310-624U5
30G MHS/WCS	2001	REC93311-632V4		REC93306-305U3	REC93602-20M02	REC93310-624U5
30H MHS	2001-03	REC93311-632V4		REC93306-305U3	REC93602-20M02	REC93310-624U5
30H WCS	2001-02	REC93311-632V4		REC93306-305U3	REC93602-20M02	
40H	1984-87	REC93306-305U8		REC93306-30510	REC93602-20M02	
40Q	1993-98		REC93311-832U4		REC93603-21111	REC93310-730V6
40Q E/M	1992		REC93311-832U4		REC93603-21111	REC93310-730V6
40R MHO	2000				REC93602-20M02	
40R ROS	2001				REC93602-20M02	
40V	1994-99	REC93306-305U8		REC93306-305U8	REC93602-20M02	
40V EO	2000	REC93306-305U8		REC93306-305U8	REC93602-20M02	
40V EOL/EOS	2001-06	REC93306-305U8		REC93306-305U8	REC93602-20M02	
40V ETO	2000	REC93306-305U8		REC93306-305U8	REC93602-20M02	
40V ETOL/ETOS	2001-03	REC93306-305U8		REC93306-305U8	REC93602-20M02	
40V MHOL/MHOS	2001-06	REC93306-305U8		REC93306-305U8	REC93602-20M02	
40V MO	2000	REC93306-305U8		REC93306-305U8	REC93602-20M02	
40V MOS	2002-05	REC93306-305U8		REC93306-305U8	REC93602-20M02	
40X	1998	REC93306-307U0	REC93332-000UE	REC93306-306V5	REC93603-21111	REC93310-727U0
40X MH	2000	REC93306-307U0	REC93332-000UE	REC93306-306V5	REC93603-21111	REC93310-727U0
40X MHL	2001-06	REC93306-307U0	REC93332-000UE	REC93306-306V5	REC93603-21111	REC93310-727U0
40X WL/WS	2001	REC93306-307U0	REC93332-000UE	REC93306-306V5	REC93603-21111	REC93310-727U0
40X WT	2000	REC93306-307U0	REC93332-000UE	REC93306-306V5	REC93603-21111	REC93310-727U0
40X WTL	2001-03	REC93306-307U0	REC93332-000UE	REC93306-306V5	REC93603-21111	REC93310-727U0
40Y ETOL	2001-06	REC93306-305U8		REC93306-305U8	REC93602-20M02	
40Y MHOS	2001-06	REC93306-305U8		REC93306-305U8	REC93602-20M02	
E40G	2003	REC93306-307U0	REC93332-000UE	REC93306-306V1	REC93603-21111	REC93310-727V7
E40J	2003	REC93306-307U0	REC93332-000UE	REC93306-306V1	REC93603-21111	REC93310-727V7
50D	1984-90	REC93306-305U8		REC93306-30510	REC93602-20M02	
50G	1993-98	REC93311-636U6		REC93306-306V1	REC93603-18M09	REC93310-522W0
50G ETO	2000	REC93311-636U6		REC93306-306V1	REC93603-18M09	REC93310-522W0
50G ETOL	2001-06	REC93311-636U6		REC93306-306V1	REC93603-18M09	REC93310-522W0
50H	1994-99	REC93306-305U8		REC93306-305U8	REC93602-20M02	REC93310-522W0
50H EDO	2000	REC93306-305U8		REC93306-305U8	REC93602-20M02	REC93310-522W0
50H EDOL/EDOS	2001-02	REC93306-305U8		REC93306-305U8	REC93602-20M02	REC93310-522W0
50H MDO/MO	2000	REC93306-305U8		REC93306-305U8	REC93602-20M02	REC93310-522W0
55B	1993-98	REC93311-632U1			REC93603-21111	REC93311-832U4
55B E	1990-00	REC93311-632U1	REC93311-832U4		REC93603-21111	REC93311-832U4
55B EHD/ET	2000	REC93311-632U1	REC93311-832U4		REC93603-21111	REC93311-832U4
55B ETL	2001-02	REC93311-632U1	REC93311-832U4		REC93603-21111	REC93311-832U4
60F	1984-98	REC93311-636U6		REC93306-306V1	REC93603-18M09	
60F EO/ETO	2000	REC93311-636U6		REC93306-306V1	REC93603-18M09	
60F ETOL	2001-06	REC93311-636U6		REC93306-306V1	REC93603-18M09	
E60HMHD	2003	REC93311-636U6		REC93306-306V1		REC93310-527W1
E60 ELHB	2003	REC93311-636U6		REC93306-306V1		REC93310-527W1
E60H MHDL	2001-06	REC93311-636U6		REC93306-306V1	REC93603-18M09	
70B	1984-98	REC93311-636U6		REC93306-306V1	REC93603-18M09	
70B EDOL	2001	REC93311-636U6		REC93306-306V1	REC93603-18M09	
70B EO/ETO	2000	REC93311-636U6		REC93306-306V1	REC93603-18M09	
70B ETOL	2001-06	REC93311-636U6		REC93306-306V1	REC93603-18M09	
75A	1993-98	REC93310-636U4	REC93310-835U8	REC93306-206U5	REC93603-21111	REC93310-730V8
75A E	1990-00	REC93310-636U4	REC93310-835U8	REC93306-206U5	REC93603-21111	REC93310-730V8
75A EDL	2001-06	REC93310-636U4	REC93310-835U8	REC93306-206U5	REC93603-21111	REC93310-730V8
75A EM	1992	REC93310-636U4	REC93310-835U8	REC93306-206U5	REC93603-21111	REC93310-730V8
75A ET/ETL	2000	REC93310-636U4	REC93310-835U8	REC93306-206U5	REC93603-21111	REC93310-730V8
75A MHD	2000	REC93310-636U4	REC93310-835U8	REC93306-206U5	REC93603-21111	REC93310-730V8
75C	1998	REC93310-636U4	REC93310-835U8	REC93306-206U5	REC93603-21111	REC93310-730V8
75C ETO	2000	REC93310-636U4	REC93310-835U8	REC93306-206U5	REC93603-21111	REC93310-730V8
75C ETOL	2001-06	REC93310-636U4	REC93310-835U8	REC93306-206U5	REC93603-21111	REC93310-730V8
80A	1985-95	REC93310-636U4	REC93310-835U8	REC93306-206U5	REC93603-21111	REC93310-730V8
85A	1996-98	REC93310-636U4	REC93310-835U8	REC93306-206U5	REC93603-21111	REC93310-730V8
85A E	1990-2000	REC93310-636U4	REC93310-835U8	REC93306-206U5	REC93603-21111	REC93310-730V8
85A ET/ETL	2000	REC93310-636U4	REC93310-835U8	REC93306-206U5	REC93603-21111	REC93310-730V8
90A	1984-98	REC93310-636U4	REC93310-835U8	REC93306-206U5	REC93603-21111	REC93310-730V8
90A ETO/ETOL	2000	REC93310-636U4	REC93310-835U8	REC93306-206U5	REC93603-21111	REC93310-730V8
100A	1998	REC93311-940U3	REC93310-954U1	REC93306-208U0	REC93310-32337	REC93310-836V2
100A ETO	2000	REC93311-940U3	REC93310-954U1	REC93306-208U0	REC93310-32337	REC93310-836V2
100A ETOL	2001	REC93311-940U3	REC93310-954U1	REC93306-208U0	REC93310-32337	REC93310-836V2
115A	1984-87	REC93311-940U3	REC93310-954V3	REC93306-208U0	REC93603-21111	REC93310-836V2
115B	1988-92	REC93311-940U3	REC93310-954V3	REC93306-208U0	REC93603-21111	REC93310-836V2
115B	1993-96	REC93311-940U3	REC93310-954V3	REC93306-208U0	REC93310-32337	REC93310-836V2
115B ETOL	2001-02	REC93311-940U3	REC93310-954U1	REC93306-208U0	REC93310-32337	REC93310-836U0
115C	1988-91	REC93311-940U3	REC93310-954V3	REC93306-208U0	REC93603-21111	REC93310-836V2
115C	1992-98	REC93311-940U3	REC93310-954V3	REC93306-208U0	REC93310-32337	REC93310-836V2
115C ETO	2000	REC93311-940U3	REC93310-954U1	REC93306-208U0	REC93310-32337	REC93310-836V2
115C ETOL	2001	REC93311-940U3	REC93310-954U1	REC93306-208U0	REC93310-32337	REC93310-836U0
115C ETOX	1988-91	REC93311-940U3	REC93310-954U1	REC93306-208U0	REC93310-32337	REC93310-836V2
130B	1992-98	REC93311-940U3	REC93310-954V3	REC93306-208U0	REC93603-21111	REC93310-836V2
130B	2001-06	REC93311-940U3	REC93310-954U1	REC93306-208U0	REC93310-32337	REC93310-836V2
130B ETO	2000-2005	REC93306-307U0	REC93332-000UE	REC93306-208U0	REC93603-21111	REC93310-836V2
130B ETOL	2001-06	REC93311-940U3	REC93310-954U1	REC93306-208U0	REC93310-32337	REC93310-836V2
130B ETOX	2001	REC93311-940U3	REC93310-954U1	REC93306-208U0	REC93310-32337	REC93310-836U0
L130B	1988-91	REC93311-940U3	REC93310-954U1	REC93306-208U0	REC93310-32337	REC93310-836V2
L130B	1992-98	REC93311-940U3	REC93310-954U1	REC93306-208U0	REC93603-21111	REC93310-836V2

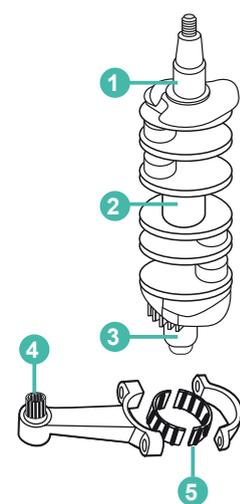



1 2 3 4 5

L130B ETO	2000	REC93311-940U3	REC93310-954U1	REC93306-208U0	REC93310-32337	REC93310-836V2
L130B ETO	2001	REC93311-940U3	REC93310-954U1	REC93306-208U0	REC93310-32337	REC93310-836V2
140A	1984-89	REC93311-940U3	REC93310-954U1	REC93306-208U0	REC93310-32337	REC93310-836V2
140B	1988-89	REC93311-940U3	REC93310-954V3	REC93306-208U0	REC93603-21111	REC93310-836V2
L140B	1989	REC93311-940U3	REC93310-954V3	REC93306-208U0	REC93603-21111	REC93310-836V2
150A	1984-89	REC93311-940U3	REC93310-954V3	REC93306-208U0	REC93603-21111	REC93310-836V2
150A ET	1998-00	REC93311-940U3	REC93310-954V3	REC93306-208U0	REC93603-21111	REC93310-836V2
150A ETL	2001-02	REC93311-940U3	REC93310-954U1	REC93306-208U0	REC93310-32337	REC93310-836V2
150A ETX	2001-02	REC93311-940U3	REC93310-954U1	REC93306-208U0	REC93310-32337	REC93310-836V2
L150C	1988-91	REC93311-940U3	REC93310-954U1	REC93306-208U0	REC93310-32337	REC93310-836V2
150C	1988-91	REC93311-940U3	REC93310-954V3	REC93306-208U0	REC93603-21111	REC93310-836V2
150C	1992-95	REC93311-940U3	REC93310-954V3	REC93306-208U0	REC93603-21111	REC93310-836V2
150F	1996-98	REC93311-940U3	REC93310-954V3	REC93306-208U0	REC93310-32337	REC93310-836V2
150F ETO	2000	REC93311-940U3	REC93310-954U1	REC93306-208U0	REC93310-32337	REC93310-836V2
150F ETOL	2001-06	REC93311-940U3	REC93310-954U1	REC93306-208U0	REC93310-32337	REC93310-836V2
150F ETOX	2001-06	REC93311-940U3	REC93310-954U1	REC93306-208U0	REC93310-32337	REC93310-836V2
D150H	1999	REC93311-940U3	REC93310-954U1	REC93306-208U0	REC93310-32337	REC93310-836V2
D150HETO	2001-02	REC93311-940U3	REC93310-954U1	REC93306-208U0	REC93310-32337	REC93310-836V2
L150A	1988-89	REC93311-940U3	REC93310-954U1	REC93306-208U0	REC93310-32337	REC93310-836V2
L150C	1990-95	REC93311-940U3	REC93310-954V3	REC93306-208U0	REC93603-21111	REC93310-836V2
L150F	1996-98	REC93311-940U3	REC93310-954V3	REC93306-208U0	REC93310-32337	REC93310-836V2
L150F ETO	2000	REC93311-940U3	REC93310-954U1	REC93306-208U0	REC93310-32337	REC93310-836V2
L150F ETOL	2001	REC93311-940U3	REC93310-954U1	REC93306-208U0	REC93310-32337	REC93310-836V2
L150 EOTX	2001	REC93311-940U3	REC93310-954U1	REC93306-208U0	REC93310-32337	REC93310-836V2
LZ150PETO	2000-06	REC93311-940U3	REC93310-954U1	REC93306-208U0	REC93310-32337	REC93310-836V2
Z150P ETO	2000	REC93311-940U3	REC93310-954U1	REC93306-208U0	REC93310-32337	REC93310-836U0
Z150P ETO	2001-06	REC93311-940U3	REC93310-954U1	REC93306-208U0	REC93310-32337	REC93310-836U0
Z150Q ETO	2000	REC93311-940U3	REC93310-954U1	REC93306-208U0	REC93310-32337	REC93310-836U0
Z150Q ETOL	2001-06	REC93311-940U3	REC93310-954U1	REC93306-208U0	REC93310-32337	REC93310-836U0
175A	1984-89	REC93311-940U3	REC93310-954U1	REC93306-208U0	REC93310-32337	REC93310-836U0
175B	1978-95	REC93311-940U3	REC93310-954V3	REC93306-208U0	REC93603-21111	REC93310-836V2
175D	1996-98	REC93311-940U3	REC93310-954V3	REC93306-208U0	REC93310-32337	REC93310-836V2
175D ETO/ETOL	2000	REC93311-940U3	REC93310-954U1	REC93306-208U0	REC93310-32337	REC93310-836V2
175D ETOX/ETOL	2001-02	REC93311-940U3	REC93310-954U1	REC93306-208U0	REC93310-32337	REC93310-836V2
175D ETOL	2001	REC93311-940U3	REC93310-954U1	REC93306-208U0	REC93310-32337	REC93310-836V2
Z175G ETOX	2001-06	REC93311-940U3	REC93310-954U1	REC93306-208U0	REC93310-32337	REC93310-836U0
200A	1984-89	REC93311-940U3	REC93310-954U1	REC93306-208U0	REC93310-32337	REC93310-836U0
200B	1990-95	REC93311-940U3	REC93310-954V3	REC93306-208U0	REC93603-21111	REC93310-836V2
200F	1996-98	REC93311-940U3	REC93310-954V3	REC93306-208U0	REC93310-32337	REC93310-836V2
200F ETO/ETOL	2000	REC93311-940U3	REC93310-954U1	REC93306-208U0	REC93310-32337	REC93310-836V2
200F ETOX	2001-06	REC93311-940U3	REC93310-954U1	REC93306-208U0	REC93310-32337	REC93310-836V2
200G	1999-02	REC93311-940U3	REC93310-954U1	REC93306-208U0	REC93310-32337	REC93310-836V2
200G ETO/ETOL	2000	REC93311-940U3	REC93310-954U1	REC93306-208U0	REC93310-32337	REC93310-836V2
L200A	1988-91	REC93311-940U3	REC93310-954U1	REC93306-208U0	REC93310-32337	REC93310-836V2
L200B	1992-95	REC93311-940U3	REC93310-954V3	REC93306-208U0	REC93603-21111	REC93310-836V2
L200F	1996-98	REC93311-940U3	REC93310-954V3	REC93306-208U0	REC93310-32337	REC93310-836V2
L200F ETO/ETOL	2000	REC93311-940U3	REC93310-954U1	REC93306-208U0	REC93310-32337	REC93310-836V2
LZ200N ETO	2000	REC93311-940U3	REC93310-954U1	REC93306-208U0	REC93310-32337	REC93310-836V2
LZ200NETO		REC93311-940U3	REC93310-954U1	REC93306-208U0	REC93310-32337	REC93310-836U0
Z200N ETO	2001-06	REC93311-940U3	REC93310-954U1	REC93306-208U0	REC93310-32337	REC93310-836U0
Z200 N ETOL	2000	REC93311-940U3	REC93310-954U1	REC93306-208U0	REC93310-32337	REC93310-836U0
Z200N ETOX/ETOL	2001-06	REC93311-940U3	REC93310-954U1	REC93306-208U0	REC93310-32337	REC93310-836U0
220A	2003-06	REC93311-940U3	REC93310-954U1	REC93306-208U0	REC93310-32337	REC93310-836U0
225A	1984-86	REC93311-940U3	REC93310-954V3	REC93306-208U0	REC93603-21111	REC93310-836V2
225A	1987-89	REC93311-940U3	REC93310-954V3	REC93306-208U0	REC93603-21111	REC93310-836V2
225D ETO	2000	REC93311-940U3	REC93310-954U1	REC93306-208U0	REC93310-32337	REC93310-836V2
225D ETOL/ETOX	2001-03	REC93311-940U3	REC93310-954U1	REC93306-208U0	REC93310-32337	REC93310-836V2
250AET	1996-06				REC93310-326V4	
250B	95-02				REC93310-326V4	
225G	99-03				REC93310-326V4	
225A	1984-86	REC93311-940U3	REC93310-954V3	REC93306-208U0	REC93603-21111	REC93310-836V2
225A	1987-89	REC93311-940U3	REC93310-954V3	REC93306-208U0	REC93603-21111	REC93310-836V2
225D ETO	2000	REC93311-940U3	REC93310-954U1	REC93306-208U0	REC93310-32337	REC93310-836V2
225D ETOL/ETOX	2001-03	REC93311-940U3	REC93310-954U1	REC93306-208U0	REC93310-32337	REC93310-836V2
250AET	1996-06				REC93310-326V4	
250B	95-02				REC93310-326V4	
225G	99-03				REC93310-326V4	
Z, LZ						
225/250/300 HP V6	1990-10	REC93306-209U1				

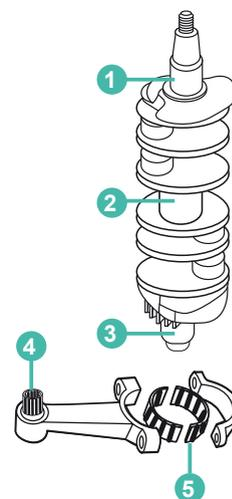

**GUÍA DE BIELAS**

**GUIDE CONNECTING ROAD**

**GUIDA BIELLE**

**GUIDE DE BIELLES**

		1	2	3	4	5
2B	1986-02	REC646-11651-02			REC646-11681-00	REC90209-18112
2MSHA/S/B	2002-03	REC646-11651-02			REC646-11681-00	
2CMHS	2010	REC646-11651-02			REC646-11681-00	
4A	1985-87	REC6E0-11651-01	REC6G1-11633-00		REC6G1-11681-00	
4AC	1987-99	REC6E0-11651-01	REC6G1-11633-00		REC6G1-11681-00	REC90209-18112
4AC MHL/HS	2001-03	REC6E0-11651-01	REC6G1-11633-00		REC6G1-11681-00	REC90209-18112
4AS	1987-96	REC6E0-11651-01	REC6G1-11633-00		REC6G1-11681-00	REC90209-18112
4BC	1998-99	REC6E0-11651-01	REC6G1-11633-00		REC6G1-11681-00	REC90209-18112
4BC	1999	REC6E0-11651-01	REC6G1-11633-00		REC6G1-11681-00	REC90209-18112
4BC MHL/HS	2001-03	REC6E0-11651-01	REC6G1-11633-00		REC6G1-11681-00	REC90209-18112
5C	1985-99	REC6E0-11651-01	REC6G1-11633-00		REC6G1-11681-00	REC90209-18112
5C MHL/MHS	2001-06	REC6E0-11651-01	REC6G1-11633-00	REC90201-12565	REC6G1-11681-00	REC90209-18112
5CS	1987-96	REC650-11651-04	REC634-11633-00	REC90201-14377	REC682-11681-00	REC90209-20159
6C	1990		REC634-11633-00	REC90201-14377	REC682-11681-00	REC90209-20159
6C	1990-98		REC634-11633-00	REC90201-14377	REC682-11681-00	REC90209-20159
6C MHL/HS	2001-06		REC634-11633-00	REC90201-14377	REC682-11681-00	REC90209-18112
6C WHL/HS	2001		REC634-11633-00	REC90201-14377	REC682-11681-00	REC90209-18112
6C	1990		REC634-11633-00	REC90201-14377	REC682-11681-00	REC90209-18112
6D	1990-98		REC634-11633-00	REC90201-14377	REC682-11681-00	REC90209-18112
6D MHL/HS	2001-06		REC634-11633-00	REC90201-14377	REC682-11681-00	REC90209-18112
6D WHS	2001		REC634-11633-00	REC90201-14377	REC682-11681-00	REC90209-18112
8C	1990-98	REC677-11651-00	REC634-11633-00	REC90201-14377	REC682-11681-00	REC90209-18112
8C	1990	REC677-11651-00	REC634-11633-00	REC90201-14377	REC682-11681-00	REC90209-18112
8C MHL/HS	2001-06	REC677-11651-00	REC634-11633-00	REC90201-14377	REC682-11681-00	REC90209-20159
8C MHX	2001-03	REC677-11651-00	REC634-11633-00	REC90201-14377	REC682-11681-00	REC90209-20159
8C WHL/HS	2001-02	REC677-11651-00	REC634-11633-00	REC90201-14377	REC682-11681-00	REC90209-20159
E8D	1997-98	REC6E0-11651-01	REC634-11633-00	REC90201-14377	REC682-11681-00	REC90209-18112
E8D MH	1999	REC6E0-11651-01	REC634-11633-00	REC90201-14377	REC682-11681-00	REC90209-18112
9.9D	1985-89	REC650-11651-04	REC634-11633-00	REC90201-14377	REC682-11681-00	
9.9D	1985-95	REC6K4-11651-00	REC634-11633-00	REC90201-14377	REC682-11681-00	
9.9D	1990-95	REC6K4-11651-00	REC634-11633-00	REC90201-14377	REC648-11681-00	REC90209-20159
9.9F	1995-99	REC648-11651-00	REC648-11633-00	REC90201-14377	REC682-11681-00	REC90209-20159
9.9F MH	2000	REC648-11651-00	REC648-11633-00	REC90201-14377	REC682-11681-00	REC90209-20159
9.9F MHL	2001-06	REC648-11651-00	REC648-11633-00	REC90201-14377	REC682-11681-00	REC90209-20159
9.9F MHS	2001-06	REC648-11651-00	REC648-11633-00	REC90201-14377	REC682-11681-00	REC90209-20159
9.9F WC	2000	REC648-11651-00	REC648-11633-00	REC90201-20M27	REC682-11681-00	
9.9F WH	2000	REC689-11651-00	REC689-11633-00	REC90201-20M27	REC689-11681-00	REC90209-24M03
9.9F WHL/HS	2001	REC689-11651-00	REC689-11633-00	REC90201-20M27	REC689-11681-00	REC90209-24M03
13.5A	1999	REC689-11651-00	REC689-11633-00	REC90201-20M27	REC689-11681-00	REC90209-24M03
13.5A MH	2000	REC689-11651-00	REC689-11633-00	REC90201-20M27	REC689-11681-00	REC90209-24M03
13.5A MHL	2001-04	REC689-11651-00	REC689-11633-00	REC90201-20M27	REC689-11681-00	REC90209-24M03
13.5A MHS	2001-04	REC689-11651-00	REC648-11633-00	REC90201-14377	REC648-11681-00	
13.5A WH	2000	REC648-11651-00	REC648-11633-00	REC90201-14377	REC648-11681-00	
15D	1985-89	REC648-11651-00	REC648-11633-00	REC90201-14377	REC648-11681-00	
15D	1985-95	REC648-11651-00	REC648-11633-00	REC90201-14377	REC648-11681-00	
15D	1990-95	REC648-11651-00	REC648-11633-00	REC90201-14377	REC648-11681-00	
15F	1995-99	REC648-11651-00	REC689-11633-00	REC90201-20M27	REC689-11681-00	REC90209-24M03
15F MH	2000	REC689-11651-00	REC689-11633-00	REC90201-20M27	REC689-11681-00	REC90209-24M03
15F MHL/HS	2001-06	REC689-11651-00	REC689-11633-00	REC90201-20M27	REC689-11681-00	REC90209-24M03
13.5A MH	2000	REC689-11651-00	REC689-11633-00	REC90201-20M27	REC689-11681-00	REC90209-24M03
13.5A MHL	2001-04	REC689-11651-00	REC689-11633-00	REC90201-20M27	REC689-11681-00	REC90209-24M03
13.5A MHS	2001-04	REC689-11651-00	REC648-11633-00	REC90201-14377	REC648-11681-00	
13.5A WH	2000	REC648-11651-00	REC648-11633-00	REC90201-14377	REC648-11681-00	
15D	1985-89	REC648-11651-00	REC648-11633-00	REC90201-14377	REC648-11681-00	
15D	1985-95	REC648-11651-00	REC648-11633-00	REC90201-14377	REC648-11681-00	
15D	1990-95	REC648-11651-00	REC648-11633-00	REC90201-14377	REC648-11681-00	
15F	1995-99	REC648-11651-00	REC689-11633-00	REC90201-20M27	REC689-11681-00	REC90209-24M03
15F MH	2000	REC689-11651-00	REC689-11633-00	REC90201-20M27	REC689-11681-00	REC90209-24M03
15F MHL/HS	2001-06	REC689-11651-00	REC689-11633-00	REC90201-20M27	REC689-11681-00	REC90209-24M03
15F WC	2000	REC689-11651-00	REC689-11633-00	REC90201-20M27	REC689-11681-00	REC90209-24M03
15F WCL	2001-03	REC689-11651-00	REC689-11633-00	REC90201-20M27	REC689-11681-00	REC90209-24M03
15F WCS	2001-02	REC689-11651-00	REC689-11633-00	REC90201-20M27	REC689-11681-00	REC90209-24M03
20C	1985-93	REC689-11651-00	REC689-11633-00	REC90201-20M27	REC689-11681-00	REC90209-24M03
20C	1986-02	REC648-11651-00	REC648-11633-00	REC90201-20417	REC648-11681-00	
20C	1993	REC6F5-11651-00	REC6F5-11633-00	REC90201-20417	REC66T-11681-00	REC90209-27M07
20C M	1990-97	REC6F5-11651-00	REC6F5-11633-00	REC90201-20417	REC66T-11681-00	REC90209-27M07
20C MH	1998	REC6F5-11651-00	REC6F5-11633-00	REC90201-20417	REC66T-11681-00	REC90209-27M07
20C MHL	2001-02	REC6F5-11651-00	REC6F5-11633-00	REC90201-20417	REC66T-11681-00	REC90209-27M07
20C MHS	2001-02	REC6F5-11651-00	REC6F5-11633-00	REC90201-20417	REC66T-11681-00	REC90209-27M07
20D	1994-98	REC6F5-11651-00	REC6F5-11633-00	REC90201-20417	REC66T-11681-00	REC90209-27M07
20D MHOL	2001-06	REC6F5-11651-00	REC6F5-11633-00	REC90201-20417	REC66T-11681-00	REC90209-27M07
20D MHOS	2001-06	REC6F5-11651-00	REC6F5-11633-00	REC90201-20417	REC66T-11681-00	REC90209-27M07
20D WOL/OS	2006	REC6F5-11651-00	REC6F5-11633-00	REC90201-20417	REC66T-11681-00	REC90209-27M07
25B	1994-02	REC689-11651-00	REC663-11633-00	REC90201-20417	REC689-11681-00	REC90209-24M03
25B MHL/HS	2001-06	REC689-11651-00	REC663-11633-00	REC90201-20417	REC689-11681-00	REC90209-24M03
25B WCS	2001-02	REC689-11651-00	REC663-11633-00	REC90201-20417	REC689-11681-00	REC90209-24M03
25D	1985-01	REC648-11651-00	REC663-11633-00	REC90201-20417	REC648-11681-00	
25D	1986-87	REC648-11651-00	REC663-11633-00	REC90201-20417	REC648-11681-00	
25D M	1990-97	REC648-11651-00	REC663-11633-00	REC90201-20417		
25D MH	1998	REC648-11651-00				
25D MHL	2001	REC648-11651-00				

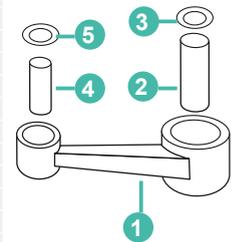

**YAMAHA**

**RECAMBIOS MARINOS**



1

2

3

4

5

25D MHS	2001	REC648-11651-00					
25N	1994-98		REC6H3-11633-00	REC90201-20417			
25N MHOL/S	2001-06	REC689-11651-00	REC663-11633-00	REC90201-20417			
25N WOL/WOS	2001-03	REC689-11651-00	REC663-11633-00	REC90201-20417			
25V	1996-98	REC689-11651-00	REC663-11633-00	REC90201-20417	REC689-11681-00	REC90209-24M03	
25V MHL/HS	2001	REC689-11651-00	REC663-11633-00	REC90201-20417	REC689-11681-00	REC90209-24M03	
25V WCS	2001	REC689-11651-00	REC663-11633-00	REC90201-20417	REC689-11681-00	REC90209-24M03	
30A	1985	REC689-11651-00	REC663-11633-00	REC90201-20417	REC689-11681-00	REC90209-24M03	
30A M	1990-92	REC689-11651-00	REC663-11633-00	REC90201-20417	REC689-11681-00	REC90209-24M03	
30D	1986-00	REC689-11651-00	REC663-11633-00	REC90201-20417			
30D EOL/EOS	2001-06	REC689-11651-00	REC663-11633-00	REC90201-20417			
30D ETOL	2001-06	REC689-11651-00	REC663-11633-00	REC90201-20417			
30D MHOL	2001-06	REC689-11651-00	REC663-11633-00	REC90201-20417			
30D MHOS	2001-05	REC689-11651-00	REC663-11633-00	REC90201-20417			
30D OL	2001-03	REC689-11651-00	REC663-11633-00	REC90201-20417			
30D EOS	2001-06		REC6R5-11633-00	REC90201-23M01			
40G/J	1986-89	REC6F5-11651-00	REC6F5-11633-00		REC6F5-11681-00	REC90209-27M11	
40R ROS	2001		REC6R5-11633-00	REC90201-23M01			
40V	1994-99	REC6H4-11651-00	REC6R5-11633-00	REC90201-23M01			
40V EO	2000	REC6E5-11651-00	REC6R5-11633-00	REC90201-23M01			
40V EOL/EOS	2001-06		REC6R5-11633-00	REC90201-23M01			
40V ETO	2000	REC6E5-11651-00	REC6E5-11633-00				
40V ETOL	2001-03	REC6E5-11651-00					
40V ETOS	2001-03	REC6E5-11651-00					
40V MHOL	2001-06	REC6E5-11651-00					
40V MHOS	2001-06		REC6E5-11633-00				
40V MO	2000		REC6R5-11633-00	REC90201-23M01			
40V MOS	2002-05		REC6R5-11633-00	REC90201-23M01			
40X	1998	REC6F5-11651-00	REC6F5-11633-00	REC90201-23M01	REC66T-11681-00	REC90209-27M07	
40X MH	2000	REC6F5-11651-00	REC6F5-11633-00	REC90201-23M01	REC66T-11681-00	REC90209-27M07	
40X MHL	2001-06	REC6F5-11651-00	REC6F5-11633-00	REC90201-23M01	REC66T-11681-00	REC90209-27M07	
40 MHS	2001-02	REC6F5-11651-00	REC6F5-11633-00	REC90201-23M01	REC66T-11681-00	REC90209-27M07	
40X W	2000	REC6F5-11651-00	REC6F5-11633-00	REC90201-23M01	REC66T-11681-00	REC90209-27M07	
40X WL	2001	REC6F5-11651-00	REC6F5-11633-00	REC90201-23M01	REC66T-11681-00	REC90209-27M07	
40X WS	2001	REC6E5-11651-00	REC6F5-11633-00		REC66T-11681-00	REC90209-27M07	
40X WT	2000	REC6E5-11651-00	REC6F5-11633-00	REC90201-23M01	REC66T-11681-00	REC90209-27M07	
40X WTL	2001-03		REC6F5-11633-00	REC90201-23M01	REC66T-11681-00	REC90209-27M07	
40Y ETOL	2001-06		REC6R5-11633-00	REC90201-23M01			
40Y MHOS	2001-06		REC6R5-11633-00	REC90201-23M01			
40GM,W,J	2003-04	REC6F5-11651-00	REC6F5-11633-00	REC90209-27M07	REC6F5-11681-00	REC90209-27M07	
50D	1984-87		REC6R5-11633-00	REC90201-23M01			
50G	1993-98	REC6H4-11651-00	REC648-11633-00		REC6G0-11681-00	REC90209-24M03	
50G ETO	2000	REC6E5-11651-00	REC648-11633-00	REC90201-23M01	REC6G0-11681-00	REC90209-24M03	
50G ETOL	2001-06		REC648-11633-00	REC90201-23M01	REC6G0-11681-00	REC90209-24M03	
50H	1994-99	REC6H4-11651-00	REC648-11633-00	REC90201-23M01	REC6G0-11681-00	REC90209-24M03	
50H EDO	2000	REC6H4-11651-00	REC648-11633-00	REC90201-23M01	REC6G0-11681-00	REC90209-24M03	
50H EDOL	2001-02	REC6H4-11651-00	REC648-11633-00	REC90201-23M01	REC6G0-11681-00	REC90209-24M03	
50H EDOS	2001-02	REC6E5-11651-00	REC648-11633-00		REC6G0-11681-00	REC90209-24M03	
50H MDO	2000	REC6E5-11651-00	REC648-11633-00	REC90201-23M01	REC6G0-11681-00	REC90209-24M03	
50H MO	2000		REC648-11633-00	REC90201-23M01	REC6G0-11681-00	REC90209-24M03	
55B	1993-98	REC688-11651-00	REC6R5-11633-00	REC90201-23M01			
70B ETOL	2001-06	REC6E5-11651-00	REC6R5-11633-00	REC90201-23M01			
75A	1993-98	REC688-11651-00	REC6R5-11633-00	REC90201-23M01			
75A E	1990-00	REC688-11651-00	REC6R5-11633-00	REC90201-23M01			
75A EDL	2001-06	REC688-11651-00	REC6R5-11633-00	REC90201-23M01			
75A EM	1992	REC688-11651-00	REC6R5-11633-00	REC90201-23M01			
75A ET	2000	REC688-11651-00					
75A ETL	2001-02	REC688-11651-00					
75A MHD	2000	REC688-11651-00					
75C	1998	REC688-11651-00					
75C ETO	2000	REC688-11651-00					
75C ETOL	2001-06	REC688-11651-00					
80A	1985-96	REC688-11651-00					
85A	1996-98	REC688-11651-00					
85A E	1990-00	REC688-11651-00					
85A ET	2000	REC688-11651-00					
85A ETL	2001-02	REC688-11651-00					
90A	1984-98	REC688-11651-00					
90A ETO	2000-00	REC688-11651-00					
90A ETOL	2001-06	REC688-11651-00					
V4-V6	21.5	REC6E5-11651-00					
E60 ELHB	2003				REC6K5-11681-00		
E60HMHD	2003				REC6K5-11681-00		
225 AET	1986		REC6E5-11633-00				
115 B	1988-90	REC6E5-11650-01	REC6K7-11633-00	REC90201-21M75			
115BE-T	1991-92	REC6E5-11650-01	REC6K7-11633-00	REC90201-21M75			
140 BETO	1988-89	REC6E5-11650-01	REC6K7-11633-00	REC90201-21M75			
150 AETO	1988-89	REC6E5-11650-01	REC6K7-11633-00	REC90201-21M75			
200-225 BETO	1990-92	REC6E5-11650-01	REC6K7-11633-00	REC90201-21M75			
175 BETO	1990-92	REC6E5-11650-01	REC6K7-11633-00	REC90201-21M75			
250A,E 225C	1990-06	REC61A-11650-00					
250B							

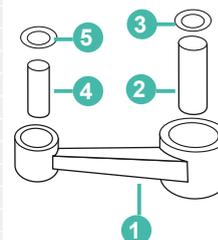

YAMAHA

RECAMBIOS  
MARINOS

# PISTONES

# PISTON

# PISTONE

# PISTONS

2T  
STROKES

## KITS DE PISTONES

La gama de pistones RECMAR®, se suministrará siempre como kit, compuesto por pistón, aros, bulón y clips. Eventualmente las referencias antiguas sufren cambios de numeración. En caso de duda contacten con nuestros técnicos comerciales.

## PISTON KITS

The RECMAR® piston assortment is always supplied as a set (piston, rings, pins and bearings). Old references may change. In case of any doubt contact our technicians.

## KIT PISTONE

La gamma dei pistoni RECMAR®, si vende sempre come kit, composto da pistoni, fasce, bulloni e clips. Le referenze vecchie avranno un cambio di numerazione. In caso di dubbi contattare i nostri tecnici commerciali.

## KIT PISTON

La gamme de pistons RECMAR® sera toujours fournie en kit, comprenant piston, segments, axe et clips. Les anciennes références subissent des modifications de numérotation. En cas de doute, contactez nos technico commerciaux

	STD Ø 50mm	
	REF	OEM
	REC6E0-11631-00-98K	6E0-11631-00-98
	REC6G1-11610-00	6G1-11610-00
	REC6G1-11633-00	6G1-11633-00
	REC93310-112V0	93310-112V0
	REC93450-13022	93450-13022
	4AC (1985-02) 4AS (1987-96) 5C (1994-98) 5CS (1994-96)	



	STD Ø 50mm		0.25		0.50	
	REF	OEM	REF	OEM	REF	OEM
	REC677-11631-00K	677-11631-00-97	REC677-11635-00K	677-11635-00	REC677-11636-00K	677-11636-00
	REC647-11610-00	647-11610-00				
	REC6G1-11633-00	6G1-11633-00	REC6G1-11633-00	6G1-11633-00	REC6G1-11633-00	6G1-11633-00
	REC93602-14118	93602-14118	REC93602-14118	93602-14118	REC93602-14118	93602-14118
	REC93450-13022	93450-13022	REC93450-13022	93450-13022	REC93450-13022	93450-13022
	E8D (1997-99) E8DMH (1998-03)					



	STD Ø 56mm		0.25		0.50	
	REF	OEM	REF	OEM	REF	OEM
	REC6E7-11631-00K	6E7-11631-00	REC6E7-11635-00K	6E7-11635-00	REC6E7-11636-00K	6E7-11636-00
	REC682-11610-01	682-11610-00	REC682-11610-11	682-11610-11	REC682-11610-21	682-11610-21
	REC634-11633-00	634-11633-00	REC634-11633-00	634-11633-00	REC634-11633-00	634-11633-00
	REC93602-14104	93602-14104	REC93602-14104	93602-14104	REC93602-14104	93602-14104
	REC93450-15023	93450-15023	REC93450-15023	93450-15023	REC93450-15023	93450-15023
	9.9D/15D (1985-95) 9.9F/FMH/MSH (1995-14) 15F/FEM/MSH/FMH/MH (1995-14)					



	STD Ø 72mm		0.25		0.50	
	REF	OEM	REF	OEM	REF	OEM
	REC6H3-11631-01K	6H3-11631-01-96	REC6H3-11635-01K	6H3-11635-01	REC6H3-11636-01K	6H3-11636-01
	REC6K5-11601-02	6K5-11601-02	REC6K5-11601-12	6K5-11601-12	REC6K5-11601-22	6K5-11601-22
	REC6H3-11633-00	6H3-11633-00	REC6H3-11633-00	6H3-11633-00	REC6H3-11633-00	6H3-11633-00
	REC93603-18M09	93603-18M09	REC93603-18M09	93603-18M09	REC93603-18M09	93603-18M09
	25B/BETO (1994-95) 50G/GEO/GETO (1993-07) 60F/FE0/FEDO/FETO/FEH/TR/TLR (1990-07) 70BEH/BEO/B/BEM/BETO/BEDO/TR (1990-13)					





	STD Ø 72mm		0.25		0.50	
	REF	OEM	REF	OEM	REF	OEM
	REC61N-11631-00K	61N-11631-00-95	REC61N-11635-00K	61N-11635-00	REC61N-11636-00K	61N-11636-00
	REC61N-11603-00	61N-11603-00	REC61N-11604-00	61N-11604-00	REC61N-11605-00	61N-11605-00
	REC689-11633-00	689-11633-00	REC689-11633-00	689-11633-00	REC689-11633-00	689-11633-00
	REC93602-20M02	93602-20M02	REC93602-20M02	93602-20M02	REC93602-20M02	93602-20M02
	REC688-11634-00	688-11634-00	REC688-11634-00	688-11634-00	REC688-11634-00	688-11634-00
	25VE/VM (1996-01) 25B/BMH (2001-10) 30G/GE (1996-00) E30HMH(2003) E30HMH/HW (2003-12)					



	STD Ø 67mm		0.25		0.50	
	REF	OEM	REF	OEM	REF	OEM
	REC6H4-11631-01K	6H4-11631-01-95	REC6H4-11635-01K	6H4-11635-01	REC6H4-11636-01K	6H4-11636-01
	REC63D-11603-00	63D-11603-00			REC63D-11605-00	63D-11605-00
	REC648-11633-00	648-11633-00	REC648-11633-00	648-11633-00	REC648-11633-00	648-11633-00
	REC93602-20M02	93602-20M02	REC93602-20M02	93602-20M02	REC93602-20M02	93602-20M02
	REC6H4-11634-01	6H4-11634-01	REC6H4-11634-01	6H4-11634-01	REC6H4-11634-01	6H4-11634-01
	25Q/QEO (1990-94) 40V/VMH/VETO/VMH/MLH/VMHO/VE/VEO/TLR/VETO/YETO/H/HE (1995-13) C40T/TLR (1995-02) 50H/HRD/HMHD/HETO/HEDO/HWM/D/DE/DEMTO (1989-03)					



	STD Ø 72mm	
	REF	OEM
	REC689-11631-00K	689-11631-00-95
	REC689-11610-00	689-11610-01
	REC689-11633-00	689-11633-00
	REC93602-20M02	93602-20M02
	REC663-11634-00	633-11634-00
	30A (1985-1992)	



	STD Ø 59mm	
	REF	OEM
	REC6J8-11631-02	6J8-11631-02-97
	25J/JEO/JETO/ESH (1990-99) 30DETO/DEO/DE/DMH/D/ELH/ DWH (1990-12)	



	STD Ø 76mm		0.25		0.50	
	REF	OEM	REF	OEM	REF	OEM
	REC6F6-11631-00K	6F6-11631-00-95	REC6F6-11635-00K	6F6-11635-00	REC6F6-11636-00K	6F6-11636-00
	REC6F5-11610-00	6F5-11610-00	REC6F5-11610-10	6F5-11610-10	REC6F5-11610-20	6F5-11610-20
	REC6F5-11633-00	6F5-11633-00	REC6F5-11633-00	6F5-11633-00	REC6F5-11633-00	6F5-11633-00
	REC93603-21111	93603-21111	REC93603-21111	93603-21111	REC93603-21111	93603-21111
	REC663-11634-00	663-11634-00	REC663-11634-00	663-11634-00	REC663-11634-00	663-11634-00
	E40GMH/JMH/JWH (2003) 40GWH/JWH (2003)					



	STD Ø 80mm		0.25		0.50	
	REF	OEM	REF	OEM	REF	OEM
	REC66T-11631-01K	66T-11631-01-93	REC66T-11635-01K	66T-11635-01	REC66T-11636-01K	66T-11636-01
	REC66T-11603-00	66T-11603-00	REC66T-11604-00	66T-11604-00	REC66T-11605-00	66T-11605-00
	REC6F5-11633-00	6F5-11633-00	REC6F5-11633-00	6F5-11633-00	REC6F5-11633-00	6F5-11633-00
	REC93603-21111	93603-21111	REC93603-21111	93603-21111	REC93603-21111	93603-21111
	REC663-11634-00	663-11634-00	REC663-11634-00	663-11634-00	REC663-11634-00	663-11634-00
	E40X/XMH/XW (2002-13) 40XMH/XW (2003-13)					



	STD Ø 67mm		0.25		0.50	
	REF	OEM	REF	OEM	REF	OEM
	REC6H4-11631-00K	6H4-11631-00-96	REC6H4-11635-00K	6H4-11635-00	REC6H4-11636-00K	6H4-11636-00
	REC6H4-11610-00-00	6H4-11610-00				
	REC648-11633-00	648-11633-00	REC648-11633-00	648-11633-00	REC648-11633-00	648-11633-00
	REC93602-20M02	93602-20M02	REC93602-20M02	93602-20M02	REC93602-20M02	93602-20M02
	REC6H4-11634-01	6H4-11634-01	REC6H4-11634-01	6H4-11634-01	REC6H4-11634-01	6H4-11634-01
	40N/E/H (1984-1988) 50D/ETN (1984-1988)					



	STD Ø 81mm		0.25		0.50	
	REF	OEM	REF	OEM	REF	OEM
	REC6H1-11631-03K	6H1-11631-03-95				
	REC688-11603-A0	688-11603-A0			REC688-11605-A0	688-11605-A0
	REC663-11633-00	663-11633-00				
	REC93603-21111	93603-21111	REC93603-21111	93603-21111	REC93603-21111	93603-21111
	55B (1996) 75 TLRB (2003) 75CETO (2004-13) 75AE/T/M/HD (1995-98) E75B (2000-02) 75AED (2003-07) 75TLR (2000-02) 80A/AETO/AEMTO (1994-02) 85A/AE (1995-02) 90A/AEO/AEMO/AETO/AET/TLR/AETO (1994-13)					



	STD Ø 82mm	
	REF	OEM
	REC688-11631-02K	688-11631-02-95
	REC688-11610-02	688-11610-02
	REC663-11633-00	663-11633-00
	REC93603-21111	93603-21111
	REC688-11634-00	688-11634-00
	55BET (1990) 55BE (1992)	



	STD	
	REF	OEM
	REC688-11631-81K	688-11631-81-96
	REC688-11610-02	688-11610-02
	REC93603-21111	93603-21111
	75A/AE (1990-93) 85A/AE (1990-93)	



	STD Ø 82mm		0.25		0.50	
	REF	OEM	REF	OEM	REF	OEM
	REC688-11631-03K	688-11631-03-94	REC688-11635-03K	688-11635-03	REC688-11636-03K	688-11635-03
	REC688-11603-A0	688-11603-A0			REC688-11605-A0	688-11605-A0
	REC663-11633-00	663-11633-00	REC663-11633-00	663-11633-00	REC663-11633-00	663-11633-00
	REC93603-21111	93603-21111	REC93603-21111	93603-21111	REC93603-21111	93603-21111
	REC688-11634-00	688-11634-00	REC688-11634-00	688-11634-00	REC688-11634-00	688-11634-00
	E48CMHS (2003) 55B/BM/BET (1993-02) E55CMH (2003-05) E75B (2000) 85A/AET/AED (2000-03)					



	STD Ø 72mm		0.25		0.50	
	REF	OEM	REF	OEM	REF	OEM
	REC6K5-11631-03K	6K5-11631-03-95	REC6K5-11635-03K	6K5-11635-03	REC6K5-11636-03K	6K5-11636-03
	REC6K5-11601-02	6K5-11601-02	REC6K5-11601-12	6K5-11601-12	REC6K5-11601-22	6K5-11601-22
	REC6H3-11633-00	6H3-11633-00	REC6H3-11633-00	6H3-11633-00	REC6H3-11633-00	6H3-11633-00
	REC93603-18M09	93603-18M09	REC93603-18M09	93603-18M09	REC93603-18M09	93603-18M09
	E60HE/HM/H/MHZ/MLHA/ELHB/HMHD -S-L (1997-13)					



	STD Ø 89mm		STD Ø 89mm	
	ESTRIBOR REF	STD   TRIBORDO   DROIT OEM	BABOR REF	PORT   BABORDO   GAUCHE OEM
	REC6R5-11631-11K	6R5-11631-11-93	REC6R5-11642-11K	6R5-11642-11-93
	REC6R5-11603-00	6R5-11603-00	REC6R5-11603-00	6R5-11603-00
	REC6R5-11633-00	6R5-11633-00		
	REC93310-32337	93310-32337	REC93310-32337	93310-32337
	REC6R5-11634-00	6R5-11634-10	REC6R5-11634-00	6R5-11634-10
	100A/AETO (1996-01) 115B (2000-02) 115CEO/CETO/TLR/TXRZ (1993-13) 130BETO/TLR (1993-07) 150 CETO/L150CETO (1993-95)		175BETO (1993-95) 200CETO (1993) 200BETO (1993-95) 225BET/BETO (1993-95)	



	STD Ø 89mm		STD Ø 89mm		0.2590		0.50	
	ESTRIBOR REF	STD   TRIBORDO   DROIT OEM	BABOR REF	PORT   BABORDO   GAUCHE OEM	REF	OEM	REF	OEM
	REC6R5-11631-01K	6R5-11631-11-93	REC6R5-11642-01K	6R5-11642-11-93				
	REC64D-11603-01	64D-11603-02	REC64D-11603-01	64D-11603-02	REC64D-11604-01	64D-11603-04	REC64D-11605-01	64D-11603-05
	REC6K7-11633-00	6K7-11633-00	REC6K7-11633-00	6K7-11633-00				
	REC93310-32337	93603-21111	REC93310-32337	93603-21111				
	REC6R5-11634-00	6R5-11634-00	REC6R5-11634-00	6R5-11634-00				
	115BE/CEO (1992) E115AEL (2003) 130BETO (1992) 150CETO (1992) 175BETO (1992) 200BETO (1992)							



	STD Ø 89mm		STD Ø 89mm	
	ESTRIBOR REF	STD   TRIBORDO   DROIT OEM	BABOR REF	PORT   BABORDO   GAUCHE OEM
	REC6G5-11631-00K	6G5-11631-00-93	REC6G5-11642-00K	6G5-11642-00-93
	REC6E5-11610-02	6E5-11610-02	REC6E5-11610-02	6E5-11610-02
	REC6E5-11633-00	6E5-11633-01	REC6E5-11633-00	6E5-11633-01
	REC93603-21111	93603-21111	REC93603-21111	93603-21111
	REC6E5-11634-00	6E5-11634-00	REC6E5-11634-00	6E5-11634-00
	115ETN (1984) 115A (1985-87) 140AETO (1984-87) 150ETN (1984) 150AETO (1985-87) 175AETO (1984-87) 200ETN (1984) 200AETO (1985-87)			



	STD Ø 89mm		STD Ø 89mm	
	ESTRIBOR REF	STD   TRIBORDO   DROIT OEM	BABOR REF	PORT   BABORDO   GAUCHE OEM
	REC64D-11631-00K	64D-11631-02-90	REC64D-11642-00K	64D-11642-02-90
	REC64D-11603-01	64D-11603-02	REC64D-11603-01	64D-11603-02
	REC6R5-11633-00	6R5-11633-10	REC6R5-11633-00	6R5-11633-10
	REC93310-32337	93310-32337	REC93310-32337	93310-32337
	REC6R5-11634-00	6R5-11634-10	REC6R5-11634-00	6R5-11634-10
	150F/FETO (1996-2007) 150TXR/TR (2002-05) 150AET (2001-02) 175D/DETO (1996-03) 200AET (2003)		200F/TLR/FETO (1996-10) 200G/GETOL (1996-02) L200F/FETO (1996-00) 225D/DET (1996-09)	





					
		ESTRIBOR   STD TRIBORDO   DROIT		BABOR   PORT BABORDO   GAUCHE	
L130B	1997-98	REC64D-11603-01	REC6R5-11631-11K	REC6R5-11642-11K	
L130BETOX	2000-01	REC64D-11603-01	REC6R5-11631-11K	REC6R5-11642-11K	
140A	1985-87	REC6E5-11610-02	REC6G5-11631-00K	REC6G5-11642-00K	
150A	1984-87	REC6E5-11610-02	REC6G5-11631-00K	REC6G5-11642-00K	
150AET	1998-00	REC64D-11603-01	REC64D-11631-00K		
150AETL/ AETX	2001-02	REC64D-11603-01	REC64D-11642-00K		
150C	1992	REC61U-11601-00	REC6R5-11631-01K	REC6R5-11642-01K	
150C	1993-05	REC6R5-11603-00	REC6R5-11631-11K	REC6R5-11642-11K	
150F	1996-01	REC64D-11603-01	REC6G5-11631-00K	REC6G5-11642-00K	
150FETO	1998-00	REC64D-11603-01	REC64D-11631-00K	REC64D-11642-00K	
150FETOL	2001-04	REC64D-11603-01	REC64D-11631-00K	REC64D-11642-00K	
150FETOX	2001-05	REC64D-11603-01	REC64D-11631-00K	REC64D-11642-00K	
D150H	1999-02	REC64D-11603-01	REC64D-11631-00K	REC64D-11642-00K	
L150C	1992	REC61U-11601-00	REC6R5-11631-01K	REC6R5-11642-01K	
L 150C	1993-95	REC6R5-11603-00	REC6R5-11631-11K	REC6R5-11642-11K	
L150F	1996-98	REC64D-11603-01	REC6G5-11631-00K	REC6G5-11642-00K	
L150FETO	2000	REC64D-11603-01	REC64D-11631-00K	REC64D-11642-00K	
L150FETOL/ FETOX	2001	REC64D-11603-01	REC64D-11642-00K	REC64D-11642-00K	
175A	1984-87	REC6E5-11610-02	REC6G5-11631-00K	REC6G5-11642-00K	
175B	1992	REC61U-11601-00	REC6R5-11631-01K	REC6R5-11642-01K	
175BETO/ CETO	1993-95	REC6R5-11603-00	REC6R5-11631-11K	REC6R5-11642-11K	
175D	1996-98	REC64D-11603-01	REC6G5-11631-00K	REC6G5-11642-00K	
175DETO	1996-00	REC64D-11603-01	REC64D-11631-00K		
175DETOX	2001-03	REC64D-11603-01	REC64D-11642-00K		
175DETOX	2001-02	REC64D-11603-01	REC64D-11642-00K		
200A	1984-87	REC6E5-11610-02	REC6G5-11631-00K	REC6G5-11642-00K	
200B	1992	REC64D-11603-01	REC6R5-11631-01K	REC6R5-11642-01K	
200B	1993-95	REC6R5-11603-00	REC6R5-11631-11K	REC6R5-11642-11K	
200F	1996-98	REC64D-11603-01	REC6G5-11631-00K	REC6G5-11642-00K	
200FETO	2000	REC64D-11603-01	REC64D-11631-00K	REC64D-11642-00K	
200FETOL/F	2001-04	REC64D-11603-01	REC64D-11631-00K	REC64D-11642-00K	

					
		ESTRIBOR   STD TRIBORDO   DROIT		BABOR   PORT BABORDO   GAUCHE	
200G	1999	REC64D-11603-01	REC64D-11631-00K	REC64D-11642-00K	
200GETO	2000	REC64D-11603-01	REC64D-11631-00K	REC64D-11642-00K	
200GETOL	2001-03	REC64D-11603-01	REC64D-11631-00K	REC64D-11642-00K	
L200B	1992	REC6R5-11603-00	REC6R5-11631-01K	REC6R5-11642-01K	
L 200B	1993-95	REC6R5-11603-00	REC6R5-11631-11K	REC6R5-11642-11K	
L200F	1996-01	REC64D-11603-01	REC6G5-11631-00K	REC6G5-11642-00K	
L200FETO	1996-00	REC64D-11603-01	REC64D-11631-00K	REC64D-11642-00K	
200FETOL	2001-04	REC64D-11603-01	REC64D-11631-00K	REC64D-11642-00K	
220A, ET, O	1985-87	REC6E5-11610-02			
225B	1993-95	REC6R5-11603-00	REC6R5-11631-11K	REC6R5-11642-11K	
225D	1996-01	REC64D-11603-01	REC6G5-11631-00K	REC6G5-11642-00K	
225DETO	1996-00	REC64D-11603-01	REC64D-11631-00K	REC64D-11642-00K	
225G	1999	REC64D-11603-01	REC64D-11631-00K	REC64D-11642-00K	
225GETO	1999-00	REC64D-11603-01	REC64D-11631-00K	REC64D-11642-00K	
225GETOL	2001-03	REC64D-11603-01	REC64D-11631-00K	REC64D-11642-00K	
L225C	1994-95	REC6R5-11603-00	REC6R5-11631-00K	REC6R5-11642-00K	
250A	1993-95	REC6R5-11603-00	REC6R5-11631-00K	REC6R5-11642-00K	
250AETO	2000	REC64D-11603-01	REC69L-11631-00K	REC69L-11642-00K	
250AETOX	2001-04	REC64D-11603-01	REC69L-11631-00K	REC69L-11642-00K	
250B	1997-98	REC64D-11603-01	REC69L-11631-00K	REC69L-11642-00K	
250BETO	2000	REC64D-11603-01	REC69L-11631-00K	REC69L-11642-00K	
250BETOX	2001	REC64D-11603-01	REC69L-11631-00K	REC69L-11642-00K	
L250AETO	2000-05	REC64D-11603-01	REC69L-11631-00K	REC69L-11642-00K	
L250AETOX	2001-06	REC64D-11603-01	REC69L-11631-00K	REC69L-11642-00K	
L250B	1997-02	REC64D-11603-01	REC69L-11631-00K	REC69L-11642-00K	
L250BETO	2000-03	REC64D-11603-01	REC69L-11631-00K	REC69L-11642-00K	
L250BETOX	2001-03	REC64D-11603-01	REC69L-11631-00K	REC69L-11642-00K	
L250GETOX	2006-10	REC64D-11603-01	REC69L-11631-00K	REC69L-11642-00K	
L250 A	1997-98	REC64D-11603-01	REC69L-11631-00K	REC69L-11642-00K	



## GUÍA CORREAS DE DISTRIBUCIÓN

## GUIDE TIMING BELT

## GUIDA CINGHIE DISTRIBUZIONE

## GUIDE DES COURROIES DE DISTRIBUTION

			REF	OEM
F6A-04/ F6A-05/ F8C-04/ F8C-05/ FT8D-04/ FT8D-05/ F9.9F/ F9.9J/ FT9.9G/ FT9.9L	2000+	60	REC68T-46241-00	68T-46241-00
F8B/ FT9.9A/ F9.9B	1985-06	64	REC6G8-46241-00	6G8-46241-00
F9.9C/ FT9.9D/ F15A	1998-08	68	REC66M-46241-00	66M-46241-00
F15C/ F20B	2007+	80	PAF20-05000003	6AH-46241-00
F20A/ F25A/ FT25B/ F30A/ F40B/ F45A	1998-09	80	REC65W-46241-00	65W-46241-00
F40A/ F50A/ FT50B/ FT50C/ F60A/ FT60B	1995+	106	REC62Y-46241-00	62Y-46241-00
F25D/ FT25F/ F30B/ F40F/ F50F/ FT50G/ FT50J/ F50H/ F60C/ F60F/ FT60D/ FT60G/ F70A	2005+	94	REC6C5-46241-00	6C5-46241-00
F80A/ F80B/ F100A/ F100B/ F100D/ F100F(L)/ F115A	1999+	135	REC67F-46241-00	67F-46241-00
F(L) 150A	2004+	147	REC63P-46241-00	63P-46241-00
F(L) 200A/ F(L) 225A	2002-11	159	REC69J-46241-00	69J-46241-00
F(L) 200C/ F(L) 225B/ F225C/ F(L) 250A/ F(L) 250B	2005+	225	REC6P2-46241-02	6P2-46241-02

# SISTEMA DE ESCAPE Y ADMISIÓN EXHAUST & INTAKE SYSTEM

# SISTEMA DI SCARICO E ASPIRAZIONE SYSTEME D'ÉCHAPPEMENT ET D'ADMISSION

## SISTEMA DE ESCAPE

## EXHAUST SYSTEM

## SISTEMA SCARICO

## SYSTÈME D'ÉCHAPPEMENT

### JUNTAS DEL SISTEMA DE ESCAPE

### EXHAUST GASKETS

### GUARNIZIONE SCARICO

### JOINTS D'ÉCHAPPEMENT

REF	OEM
REC6G1-41133-A0	6G1-41133-A0
	6C/CEM/D/DEM/TRV/MSH/MHS/CWH/DMH/J 8CEM/C/TRV/MSH/MH/CMH/J/N



REF	OEM
PAF25-05080004	65W-14457-10
	F20/25 T25



REF	OEM
PAF15-04010004	66M-41138-00
	F9.9/15/13.5 T9.9



REF	OEM
REC62Y-45127-00	62Y-45127-00
	F20/25/40/45/50 T50



REF	OEM
PAF15-03000003	66M-45115-00
	F9.9/13.5/15 T9.9



REF	OEM
REC62Y-41133-00	62Y-41133-00
	F20/25/40/45/50 T50



REF	OEM
REC682-41133-A0	682-41133-A0
	9.9D E9.9DMH 15D E15DMH



REF	OEM
REC67C-41133-00	67C-41133-00
	F20/25/40/50/30 T25



REF	OEM
REC63V-41133-A1	63V-41133-A1
	9.9F/FEM/FMH/MH/AW/MSH 13.5AWH

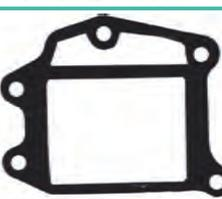

REF	OEM
REC67C-45123-00	67C-45123-00
	F20/25/40/50/30 T25



REF	OEM
REC6L2-41133-A3	6L2-41133-A3
	20D/DEM/DEO/MLH/DMH 25NE/NW/MLH/N/MSH/MH/MLH



REF	OEM	
REC663-45123-00	663-45123-00	
	25QE0 40H/N F40/45/50 50ETN	T50 55B E55CM



REF	OEM
REC6L2-41134-00	6L2-41134-00
	20D/DEM/DEO/MLH/DMH 25NE/NW/MLH/N/MSH/MH/MLH



REF	OEM
REC664-41134-A0	664-41134-A0
	20C/CM/A/G/GE E25A/25VE/VM/DE/D

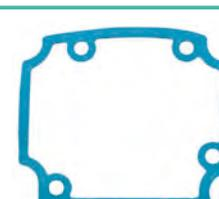

YAMAHA

RECAMBIOS MARINOS

REF	OEM
REC63D-45123-00	63D-45123-00

 25AE0/50H/40V/YE  
C40M/40TLR/50DE



REF	OEM
REC688-41134-00	688-41134-A0

 75A/AE/AED/CETO/TLR  
80A/AEO  
85A/AED-T  
90A/AET/AEO



REF	OEM
REC6H3-45127-00	6H3-45127-00

 25B/BETO  
50G/GEO/GETO  
60FE/FET/FEO/FETO/FEDO  
E60H/MHZ/MLH/HMH/HW



REF	OEM
REC688-45123-00	688-45123-00

 75CETO/TLR  
E75B/AED  
80A/AE/TLR  
85A/AE  
90A/AE/TLR/TR



REF	OEM
REC6H3-45123-00	6H3-45123-00

 25B/BETO  
50G/GEO/GETO  
60FE/FET/FEO/FETO/FEDO  
E60H/MHZ/MLH/HMH/HW  
70B/ETN/  
BEH/BE0/BEM0/BETO/CE



REF	OEM
REC67F-41138-00	67F-41138-00

 F80/100/115



REF	OEM
REC6H4-41134-A0	6H4-41134-A0

 25QEO/50H/40V/YE  
C40M/40TLR/50DE



REF	OEM
REC67F-45127-00	67F-45127-00

 F80/100/115



REF	OEM
REC66T-41133-A1	66T-41133-A0

 40X/XW/XMH  
E40X/MLN



REF	OEM
REC67F-45123-00	67F-45123-00

 F75/80/100



REF	OEM
REC676-41133-A0	676-41133-A0

 40QE/QE-Z/QM/QWC

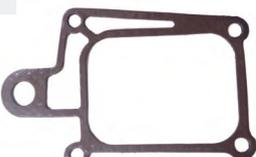

REF	OEM
REC67F-41134-A0	67F-41134-A0

 F80/100/115

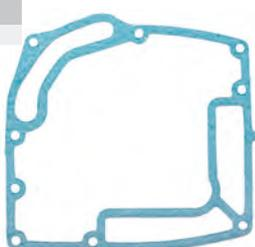

REF	OEM
REC676-45128-00	676-45128-00

 40QE/QE-Z/QM/QWC

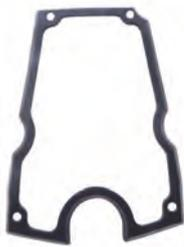

REF	OEM
REC68V-45123-00	68V-45123-00

 F80/100/115



REF	OEM
REC676-45127-00	676-45127-00

 40QE/QE-Z/QM/QWC



REF	OEM
REC6E5-41135-A0	6E5-41135-A0

 100A/AET/TLR  
115B/BETO/CEO/CETO/TXR  
130BETO



REF	OEM
REC6E5-41134-A0	6E5-41134-A0

 100A/AET/TLR  
 115B/BETO/CEO/CETO/TXR, 130BETO



REF	OEM
REC6S1-41136-00	6S1-41136-00

 F200/225/250

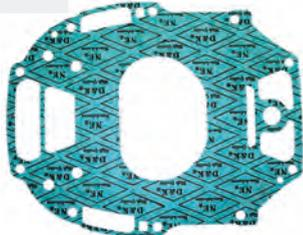

REF	OEM
REC6G5-41134-A1	6G5-41134-A1

 130BETO  
 150FETO/PETO/TR  
 175DETO/GETO/TR  
 Z200  
 200AET/ FETO/NETO/TXR  
 225DET



REF	OEM
REC6AW-41134-01	6AW-41134-00

 FL/F300-350 (2008+)



REF	OEM
REC69J-41138-00	69J-41138-00

 F200/225/250



REF	OEM
REC6A1-14613-A0	6A1-14613-A0, 00, 01

 2B/C/M (1985-10)  
 2T/strokes

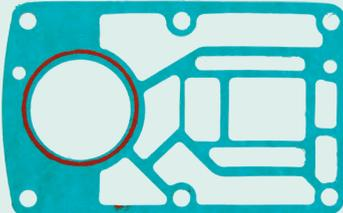

**new**

REF	OEM
REC69J-45123-00	69J-45123-00

 F200/225/250



REF	OEM
REC69J-41135-A0	69J-41135-A0

 F200/225/250

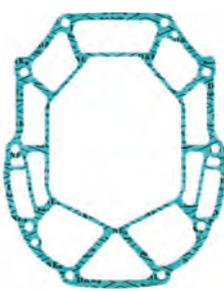

REF	OEM
REC93101-13M27	93101-13M27

 E9.9/E15  
 F9.9/F15 (modelos antiguos | old models | modello vecchio | anciens)



**new**

REF	OEM
REC69J-41134-A0	69J-41134-A0

 F200/225

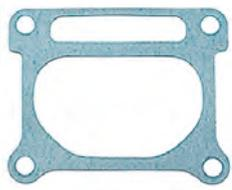

**JUNTAS DE COLECTOR Y CARTER**

**GASKET, UPPERCASING, OIL PAN, MANIFOLD**

**GUARNIZIONI COLLETTORE E CARTER**

**JOINTS DE COLLECTEUR ET CARTER D'HUILE**

REF	OEM
REC646-14623-A1	646-14623-A1

 2B

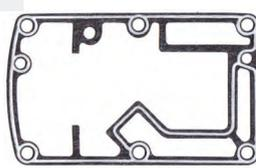

REF	OEM
PAF4-04000002	68D-11351-A0

 F4



REF	OEM
PAF2.6-04000004	69M-11351-A0

 F2.5

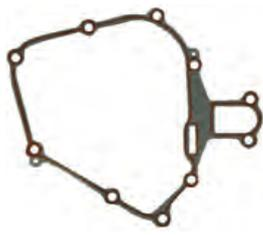

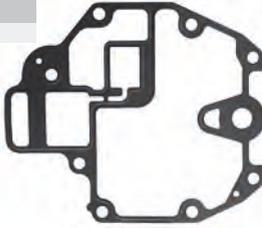

REF	OEM
REC68T-13475-00	68T-13475-00
 F6/8/9.9 T8/9.9	

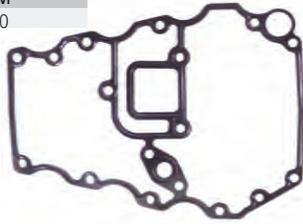
REF	OEM
REC67C-15312-00	67C-15312-00
 F25/30/40 T25	

REF	OEM
REC6G8-45113-A1	6G8-45113-A1
 F8/9.9 T9.9	

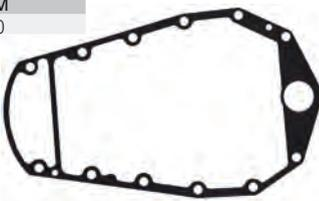
REF	OEM
REC67C-45113-00	67C-45113-00
 F25/30/40 T25	

REF	OEM
REC6AH-13329-00	6AH-13329-00
 F9.9/13.5/15/20	

REF	OEM
REC6H3-45114-A1	6H3-45114-A1
 25B/BETO 50G/GEO/GETO 60FEDO/TLR/BEO E60H/MLHMHM 70B/BEO 70BETO/TR	

REF	OEM
REC682-45113-A0	682-45113-02
 9.9D 15D	

REF	OEM
PAF25-02010007	67C-15312-00
 F25/30/40 T25	

REF	OEM
REC6AH-15312-00	6AH-15312-00
 F9.9/13.5/15/20	

REF	OEM
REC676-45114-A1	676-45114-A1
 40QE/QE-Z/QM/QWC/GWH/JWH E40GMH/JMH	

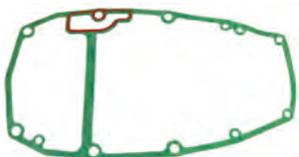
REF	OEM
PAF15-00000005	66M-45113-00
 F15/9.9/13.5 FT9.9	

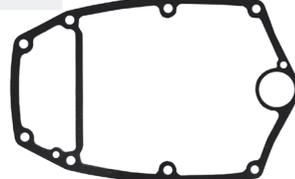
REF	OEM
REC66T-45114-A0	66T-45114-A0
 40X/XMH/XW E40X/MLH/XMH	

REF	OEM
REC62Y-15312-00	62Y-15312-00
 F20/25/40/45/50 T50	

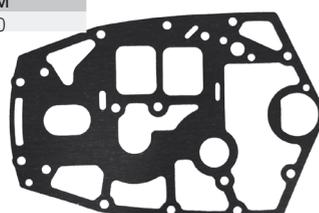
REF	OEM
REC697-45114-00	697-45114-A0
 E48CMH 55BET/B/BE/BM E55CMH	

REF	OEM
REC63D-45114-A0	63D-45114-A0

 50H/HR/HM  
 40V/VM/VETO/C40MLH  
 C40T/TLR  
 40YETO



REF	OEM
REC63P-15312-00	63P-15312-00

 F150/175/200



REF	OEM
REC688-45114-A1	688-45114-A1

 75A/AE/CETO/TLR/AED  
 E75B  
 85A/AED-M-T  
 80A/AE/AEO  
 90A/ETN/AEO/AETO

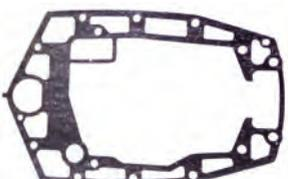

REF	OEM
REC61A-41134-A0	6D0-41134-00

 225C/FETO/G/GETO  
 Z250  
 250B/AET/BETO/TXR  
 Z300/AETO/TR

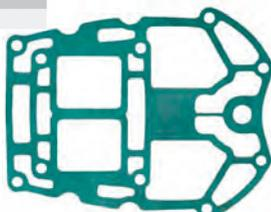

REF	OEM
REC67F-45113-00	67F-45113-00

 F75/80/100/115

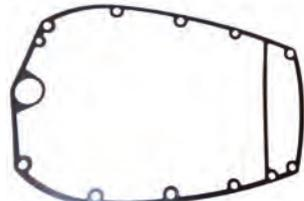

REF	OEM
REC6AW-45113-00	6AW-45113-00

 F300/350

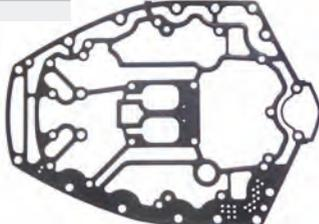

REF	OEM
REC68V-15312-00	68V-15312-00

 F80/100/115

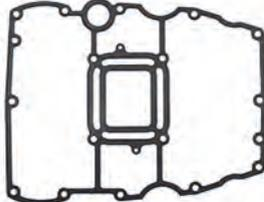

REF	OEM
REC6AW-15312-00	6AW-15312-00

 FL/F300-350 (2008+)



REF	OEM
REC6G5-45114-A0	6G5-45114-A1

 115A/B/ETN/BETO  
 130BETO  
 140AETO/BETO  
 150ETN/AETO/CETO/FETO  
 Z150  
 Z175  
 175AETO  
 200ETN/AET-0  
 Z200  
 225AETO/DET

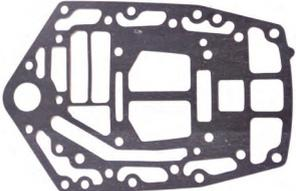

REF	OEM
REC6AW-15451-00	6AW-15451-00

 FL/F300-350 (2008+)

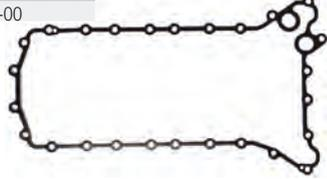

REF	OEM
REC6E5-45114-00	6E5-45114-A0

 115A/ETN  
 E115AEL  
 140AETO



REF	OEM
REC6AW-14613-00	6AW-14613-00

 FL/F300-350 (2008-11)



REF	OEM
REC6AW-14623-00	6AW-14623-00

 FL/F300-350 (2008-11)



# SISTEMA DE ADMISION

# INTAKE SYSTEM

# SISTEMA ASPIRAZIONE

# SYSTEME D'ADMISSION

## JUNTAS DEL SISTEMA DE ADMISION

## GASKETS INTAKE

## GUARNIZIONE SISTEMA ASPIRAZIONE

## JOINTS D'ADMISSION

REF	OEM
REC69J-13645-00	69J-13645-A1

 F200/FL-LF200 (2002-11)  
 F225/LF-FL225 (2002-11)



REF	OEM
REC6G8-15374-00	6G8-15374-00

 F8BE/BM/B  
 F9.9B/BE/BM/A/AM



REF	OEM
REC69J-15451-00	69J-15451-A1

 F200/FL-LF200 (2002-11)  
 F225/LF-FL225 (2002-11)

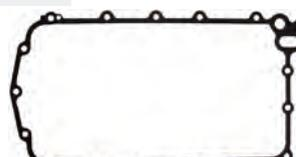

REF	OEM
REC677-24434-02	677-24434-02

 E8D/DMH  
 9.9D/15D  
 25D/NH/NMH/MH/NE/NEMO  
 20DMH/MLH/DW

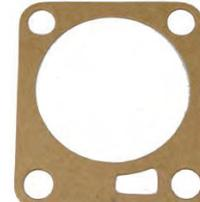

REF	OEM
REC6G1-13645-A1	6G1-13645-A1

 6D/DMH/CMH//MH/C/TRV  
 8C/CMH/MH/MSH



REF	OEM
REC677-13621-00	677-13621-A1

 20CM/C  
 25DE/BMH/B/D/V  
 30A/HM/HW/G/GE  
 E30HMH



REF	OEM
REC6G1-14198-A1	6G1-14198-A1

 6D/DMH/CMH//MH/C/TRV  
 8C/CMH/MH/MSH



REF	OEM
REC677-14198-A1	677-14198-A1

 20CM/C  
 25DE/BMH/B/D/V  
 30A/HM/HW/G/GE  
 E30HMH



REF	OEM
REC6G1-13621-A1	6G1-13621-A1

 6D/DMH/CMH//MH/C/TRV  
 8C/CMH/MH/MSH

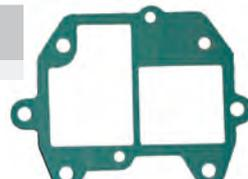

REF	OEM
REC682-13621-00	682-13621-A0

 9.9D  
 15D



REF	OEM
REC6G8-14198-A0	6G8-14198-00

 F8BE/BM/B  
 F9.9B/BE/BM/A/AM



REF	OEM
REC648-13645-A0	648-13645-A0

 20CM/C  
 25DE/BMH/B/D/V  
 30A/HM/HW/G/GE, E30HMH



REF	OEM
REC6G8-13645-00	6G8-13645-00

 F8BE/BM/B  
 F9.9B/BE/BM/A/AM



REF	OEM
REC6G8-13646-A0	6G8-13646-00

 F8BE/BM/B  
 F9.9B/BE/BM/A/AM



REF	OEM
REC648-13621-A0	648-13621-A1

 20CM/C  
 25DE/BMH/B/D/V  
 30A/HM/HW/G/GE  
 E30HMH

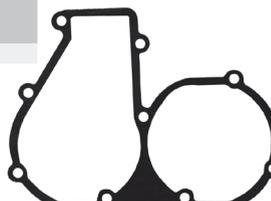

REF	OEM
REC648-14198-A0	648-14198-A0

 20C/CM  
 25D/DE  
 30A



REF	OEM
REC6H4-14198-09	6H4-14198-00

 40N/H/E  
 50D/ETN



REF	OEM
REC6H4-14198-01	6H4-14198-01

 25Q/QEO/B  
 50D/G/GEO/GET/H  
 40V/VM/TLR/H  
 C40T/40YET  
 60FEO/FET/D  
 70B/BE



REF	OEM
REC676-13646-A0	676-13646-A0

 40QE/QM/QWC



REF	OEM
REC6L2-13621-00	6L2-13621-00

 25N/M 6L2-6L29, 6L2A - 6L2D  
 (1988-13)

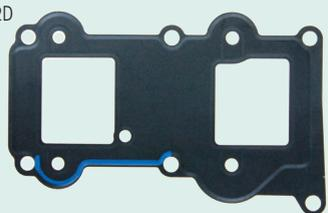

REF	OEM
REC688-14483-A0	688-14483-A0

 E40CMH  
 55B/BE/BET  
 E55CMH



REF	OEM
REC61N-14198-00	61N-14198-00

 25VE/VM/B/BMH/BWH  
 E25A/BMH  
 30G/GE/HMH/HW  
 E30HMH



REF	OEM
REC688-14416-01	688-14416-01

 75AET/AEM/AED  
 E75B  
 85A/AE/AET/AED



REF	OEM
REC6H3-13621-A1	6H3-13621-A1

 25B  
 50G/GEO/GETO,  
 60FEO/FETO/TLR/TRZ/F  
 E60H/E60M  
 70BEO/B/BE/  
 BEDO/BETO/TR



REF	OEM
REC688-13621-A1	688-13621-A1

 75AET/AEM/AED  
 E75B  
 85A/AE/AET/AED



REF	OEM
REC6H3-14198-A1	6H3-14198-A1

 25B  
 50G/GEO/GETO  
 60FEO/FETO/TLR/TRZ/F  
 E60H/E60M  
 70BEO/B/BE/  
 BEDO/BETO/TR



REF	OEM
REC688-14198-A1	688-14198-A2

 Z150P/Q/TLR  
 175G/GET  
 200NETO/N/TR/PET  
 250G/GET/B



REF	OEM
REC6H3-13622-A1	6H3-13622-A1

 25B  
 50G/GEO/GETO  
 60FEO/FETO/TLR/TRZ/F  
 E60H/E60M  
 70BEO/B/BE/BEDO/BETO/TR



REF	OEM
REC6F5-13645-A0	6F5-13645-A1

 40GWH/JWH  
 E40GMH/JMH



REF	OEM
REC6F5-13646-A2	6F5-13646-A1

 40GWH/JWH  
 E40GMH/JMH



REF	OEM
REC6F5-13621-A1	6F5-13621-A1

 40GWH/JWH  
 E40GMH/JMH



REF	OEM
REC6E5-14198-A2	6E5-14198-A2

 100A/TLR  
 115BE/B/CETO/TXR  
 130BETO/TLR  
 150F/FETO/TXR/TR/GETO/A/AETO  
 175DETO/D/FETO  
 225DET/D



REF	OEM
REC6F5-14198-A1	6F5-14198-A1

 40GWH/JWH  
 E40GMH/JMH



REF	OEM
REC6E5-14416-A1	6E5-14416-A1

 115B/BE/BET  
 C115TLR

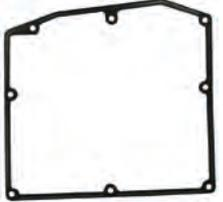

REF	OEM
REC6E9-14198-A0	6E9-14198-A0

 40QE/QM/QWC



REF	OEM
REC6E5-11381-A1	6E5-11381-A1

 115BET/CEO  
 130BET  
 150CET  
 175BET  
 200CETO  
 225BET



REF	OEM
REC663-14483-A0	663-14483-A0

 E40CMH  
 55B/BE/BET  
 E55CMH



REF	OEM
REC6E5-14483-A1	6E5-14483-A1

 115B/BE/BET  
 C115TLR



REF	OEM
REC663-14198-00	663-14198-A0

 E48CMHS  
 55BET/B/BE/BM



REF	OEM
REC65L-13646-00	65L-13646-00

 150PETO/QETO/TXR  
 175GETO  
 200N/NETO/PET/TLR  
 225G/GET

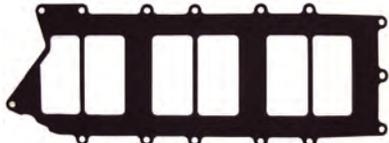

REF	OEM
REC663-13621-00	663-13621-A0

 E48CMHS  
 55BET/B/BE/BM



REF	OEM
REC6E5-13645-A1-00	6E5-13645-A1

 100A/TLR  
 115BE/B/CETO/TXR  
 130BETO/TLR  
 150F/FETO/TXR/TR/GETO/A/AETO  
 175DETO/D/FETO  
 225DET/D

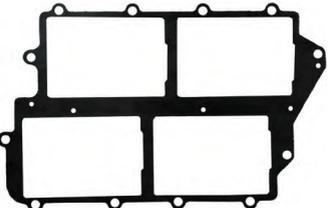

REF	OEM
REC65L-13645-00	65L-13645-00

 150PETO/QETO/TXR  
 175GETO  
 200N/NETO/PET/TLR  
 225G/GET



REF	OEM
REC6E5-13621-A1	6E5-13621-A1

 100A/TLR  
 115BE/B/CETO/TXR  
 130BETO/TLR  
 150F/FETO/TXR/TR/GETO/A/AETO  
 175DETO/D/FETO  
 225DET/D



REF	OEM
REC6G5-14416-A1	6G5-14416-A1

 150A-AET

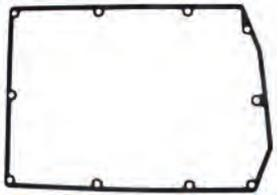

REF	OEM
REC6G5-14483-01	6G5-14483-A1

 150A/AETO  
 175AE/AETO  
 200AET/AETO



REF	OEM
REC61A-13646-00	61A-13646-00

 225C/CET  
 250AET/B/A/ETD



REF	OEM
REC6G5-13645-A1	6G5-13645-A2

 150A/AETO  
 175AE/AETO  
 200AET/AETO

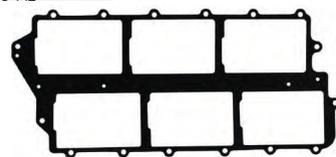

REF	OEM
REC68F-11381-00	68F-11381-00

 Z150  
 VZ150  
 LZ150  
 Z175  
 VZ175

Z200  
 VZ200  
 LZ200



REF	OEM
REC64E-13645-A0	64E-13645-A0

 150GETO  
 D150H 175DET  
 200GETO/G  
 225D/DET



REF	OEM
REC6K7-13645-A2	6K7-13645-A2

 200CETO  
 225BET



REF	OEM
REC61A-13621-A0	61A-13621-A0

 Z150P/Q/TLR  
 175G/GET  
 200NETO/N/TR/PET  
 250G/GET/B



REF	OEM
REC6K7-13646-A2	6K7-13646-A2

 200CETO  
 225BET



REF	OEM
REC61A-11381-A0	61A-11381-A0

 225C/CET/FET/G/GET  
 250AET/B

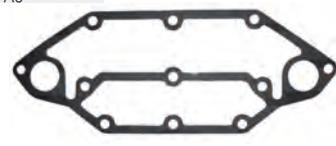

REF	OEM
REC60V-13621-A0	60V-13621-A0

 Z300AETO/TR  
 Z250DETO/TR/FETO  
 LZ250 (2003-07)  
 LZ300 (2004-07)  
 VZ200 (2005-09)  
 VZ225 (2003-09)  
 VZ300 (2004-09)  
 VZ250 (2003-07)  
 Z300 (2004-07)



REF	OEM
REC61A-13645-00	61A-13645-00

 225C/CET  
 250AET/B/A/ETD



REF	OEM
REC60V-13645-00	60V-13645-00

 Z300AETO/TR  
 Z250DETO/TR/FETO  
 LZ250 (2003-07)  
 LZ300 (2004-07)  
 VZ200 (2005-09)  
 VZ225 (2003-09)  
 VZ300 (2004-09)  
 VZ250 (2003-07)  
 Z300 (2004-07)



# UNIDADES DE TRANSMISIÓN UNIT DRIVES & COMPONENTS

# UNITÀ DI TRASMISSIONE EMBASES ET PIECES

## COLA COMPLETA

## COMPLETE GEARCASE ASSY

## PIEDI COMPLETI

## EMBASE COMPLETE

4T  
STROKES

### COLAS DE 4 TIEMPOS

### 4 STROKES GEARCASE

### PIEDI 4 TEMPI

### EMBASES DE MOTEUR 4T

REF	OEM		REDUCCIÓN GEAR RATIO RIDUZIONE REDUCTION
PAF2.6-03020000S	69M-65300-01-4D	17"	2.08
PAF2.6-03020000L	69M-65300-11-4D	22"	2.08

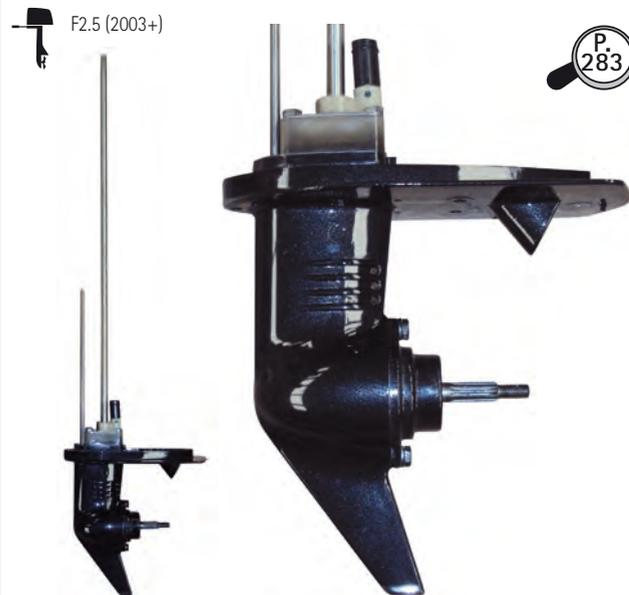

REF	OEM		REDUCCIÓN GEAR RATIO RIDUZIONE REDUCTION
PAF15-06100000S	66M-45300-02-4D	17.3"	2.08
PAF15-06100000L	66M-45300-11-4D	22.3"	2.08

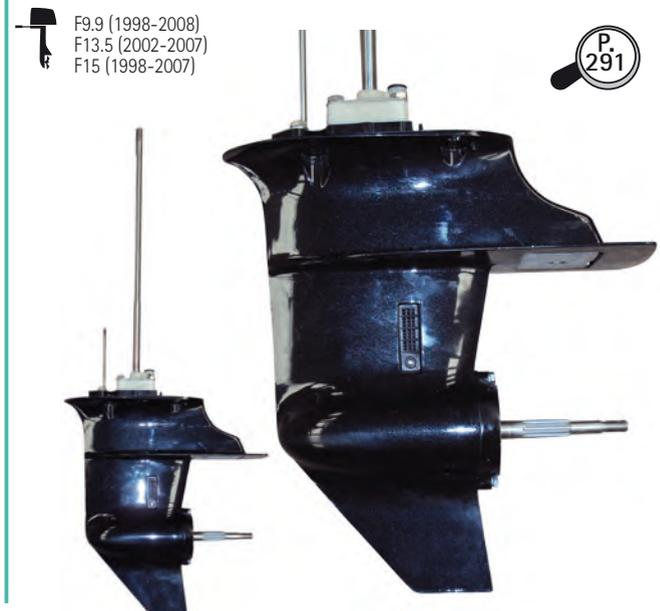

REF	OEM		REDUCCIÓN GEAR RATIO RIDUZIONE REDUCTION
PAF4-03100000S	68D-65300-03-4D	17.1"	2.08
PAF4-03100000L	68D-65300-11-4D	22.1"	2.08

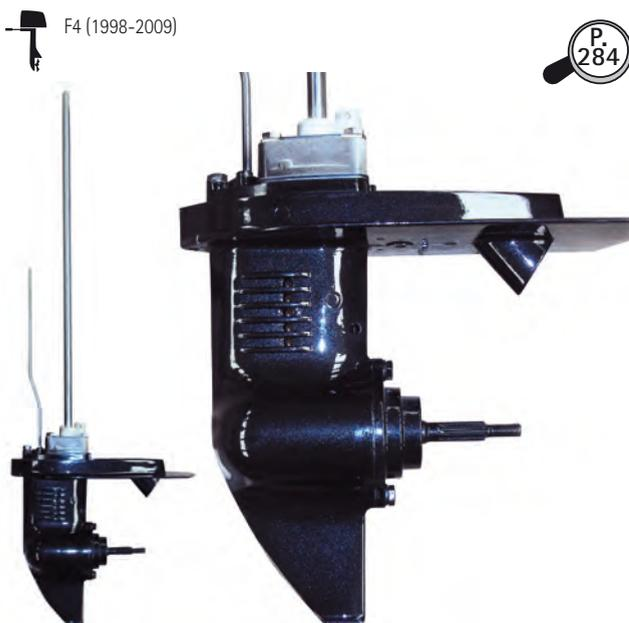

REF	OEM		REDUCCIÓN GEAR RATIO RIDUZIONE REDUCTION
PAF20-04000000S	6AH-45300-00-4D 6AH-45300-00-8D	17.1"	2.08
PAF20-04000000L	6AH-45300-10-4D 6AH-45300-10-8D	22.1"	2.08



YAMAHA

RECAMBIOS  
MARINOS

REF	OEM		REDUCCIÓN GEAR RATIO RIDUZIONE REDUCTION
PAF25-04090000S	65W-45300-01-4D	16.6"	2.08
PAF25-04090000L	65W-45300-01-4D	21.6"	2.08

F20 (1998-2003)  
F25 (1998+)

P. 294

new

REF	OEM		REDUCCIÓN GEAR RATIO RIDUZIONE REDUCTION
PAF60-04000000	69W-45300-00-4D 69W-45300-00-8D 69W-45300-01-8D	20"	1.85

F40D/H (2006+)  
F50F/H/T (2005+)  
F60A/B/C/T (2002+)

P. 310

STD	CONTRAROTACIÓN COUNTERROTATION CONTROROTANTE CONTRE ROTATION	OEM		REDUCCIÓN GEAR RATIO RIDUZIONE REDUCTION
REC416-B20F		63P-45300-00-8D	20" V6 90°	2.0:1
REC416-B25F		63P-45300-10-8D	25" V6 90°	2.0:1
	REC418-B25F	64P-45300-10-8D	25" V6 90°	2.0:1

20" --> F150HP  
25" --> LF150 HP  
V6

P. 326

P. 326

DUAL WATER PICKUP

STD	CONTRAROTACIÓN COUNTERROTATION CONTROROTANTE CONTRE ROTATION	OEM		REDUCCIÓN GEAR RATIO RIDUZIONE REDUCTION
REC422-B25F		6P2-45300-20-8D 6P2-45300-21-8D 6P2-45300-40-8D 6P2-45300-41-8D 6P3-45300-40-8D	25"	2.00:1
	REC429-B25F	6P3-45300-41-8D 6P3-45300-42-8D	25"	2.00:1

F200  
F250

P. 336

new

P. 336



STD	CONTRAROTACIÓN COUNTERROTATION CONTROROTANTE CONTRE ROTATION	OEM		REDUCCIÓN GEAR RATIO RIDUZIONE REDUCTION
REC421-B25F		69J-45300-21-8D	25" V6 76°	2.0:1
REC421-B30F		69J-45300-32-8D	30" V6 76°	2.0:1
	REC428-B25F	69K-45300-21-8D	25" V6 90°	2.0:1
	REC428-B30F	69K-45300-34-8D	30" V6	2.0:1

P. 330

F200 HP  
F225 HP

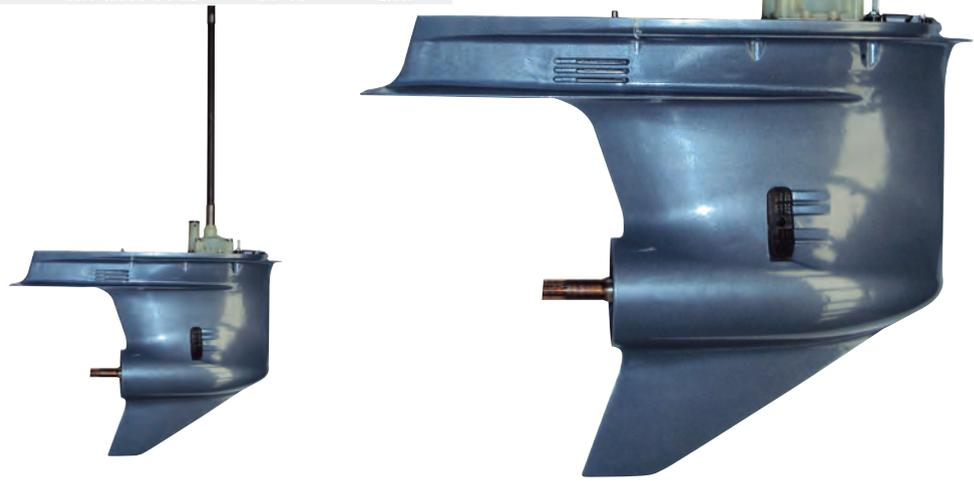

2T  
STROKES

COLAS DE 2 TIEMPOS    2 STROKES GEARCASE    PIEDI 2 TEMPI    EMBASES DE MOTEUR 2 TEMPS

REF	OEM		REDUCCIÓN GEAR RATIO RIDUZIONE REDUCTION
REC63V-45300-13-8D	63V-45300-13-8D		
	63V-45300-13-4D	L 22.3"	2.08
	63V-45300-10-4D		
REC63V-45300-03-8D	63V-45300-03-8D		
	63V-45300-03-4D	S 17.3"	2.08
	63V-45300-00-4D		

9.9 /15 HP (63V Et 63W) (1995+)  
13.5 HP (66S)

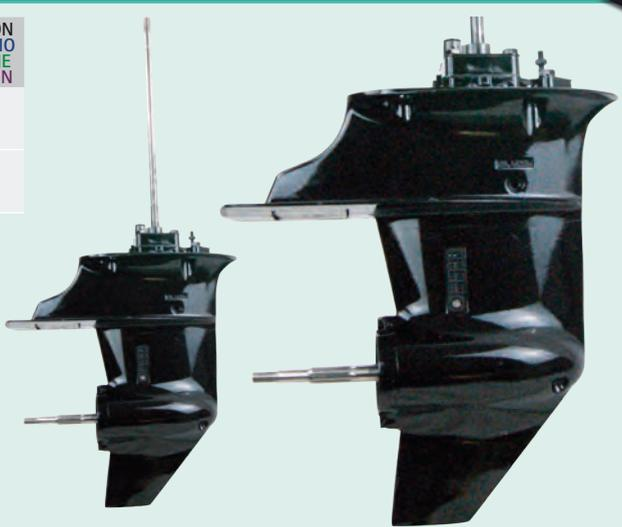

new

P. 350

REF	OEM		REDUCCIÓN GEAR RATIO RIDUZIONE REDUCTION
PAF40-04000000L	66T-45300-10-4D 66T-45311-13-8D	20"	2.08

(E)40X/M (1998-09)

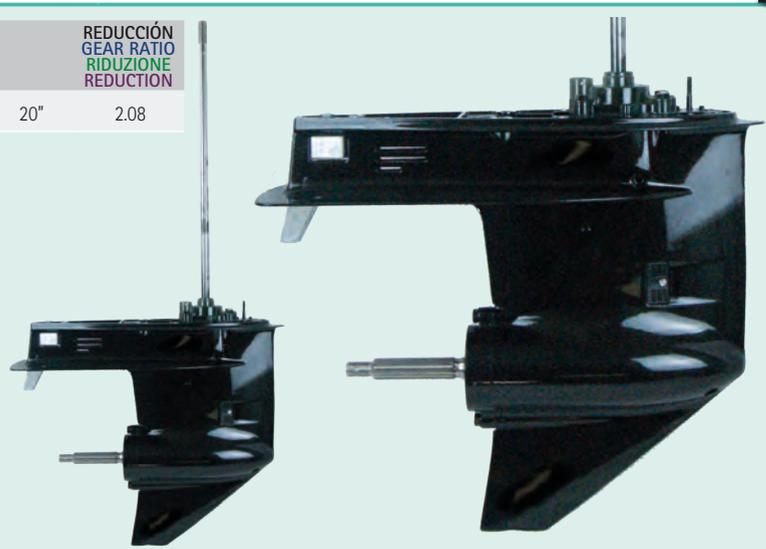

new

P. 360

YAMAHA

RECAMBIOS  
MARINOS

REF	OEM	
REC692-45300-16-8D	692-45300-16-8D	L
	692-45300-14-4D	
	692-45300-13-4D	
	692-45300-12-4D	

 75A (692) (1995-09)  
 85A (688) (1995-09)

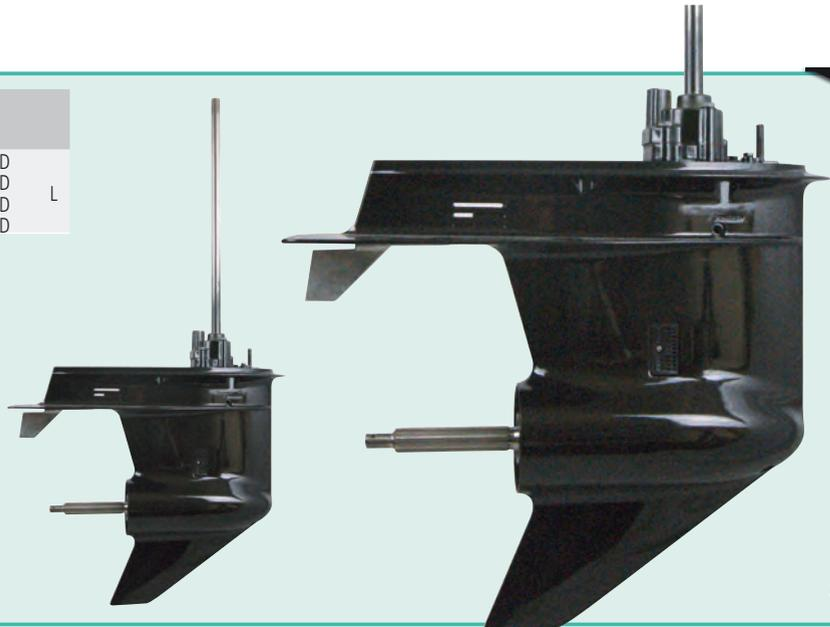

P. 370

STD	OEM		REDUCCIÓN GEAR RATIO RIDUZIONE REDUCTION
REC405-A20	6E5-45300-17-8D	20° V4	2.0:1
REC405-A25	6E5-45300-27-8D	25° V4	2.0:1

 115HP (1984+)  
 130HP (1987+)

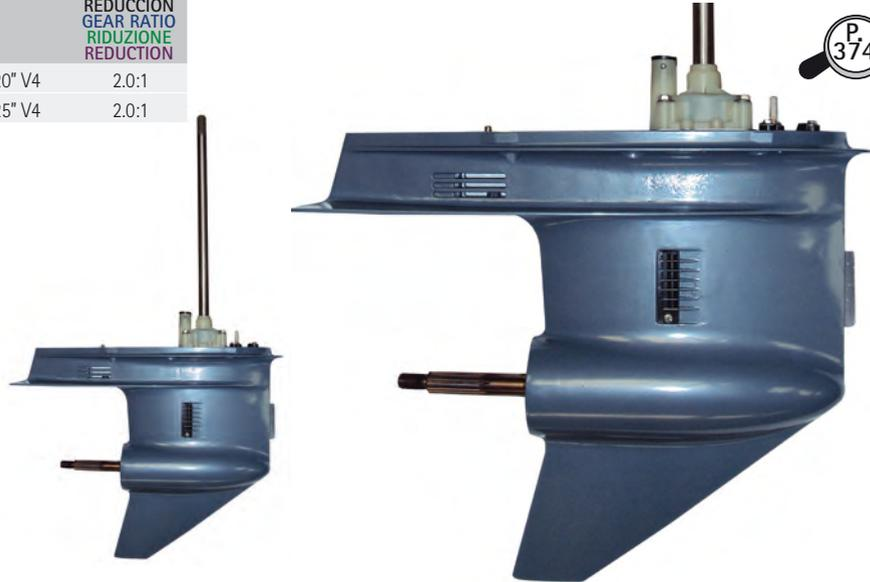

P. 374

STD	CONTRAROTACIÓN COUNTERROTATION CONTROROTANTE CONTRE ROTATION	OEM		REDUCCIÓN GEAR RATIO RIDUZIONE REDUCTION	
REC416-A20		64D-45300-01-8D	20° V6 90° 2.6L	1.86:1	
REC416-A25		64D-45300-21-8D	25° V6 90° 2.6L	1.86:1	
		REC418-A25	64P-45300-10-8D	25° V6 90° 2.6L	1.86:1

 150HP (1984+)  
 175HP (1984+)  
 200HP (1984+)  
 225HP (1990+)

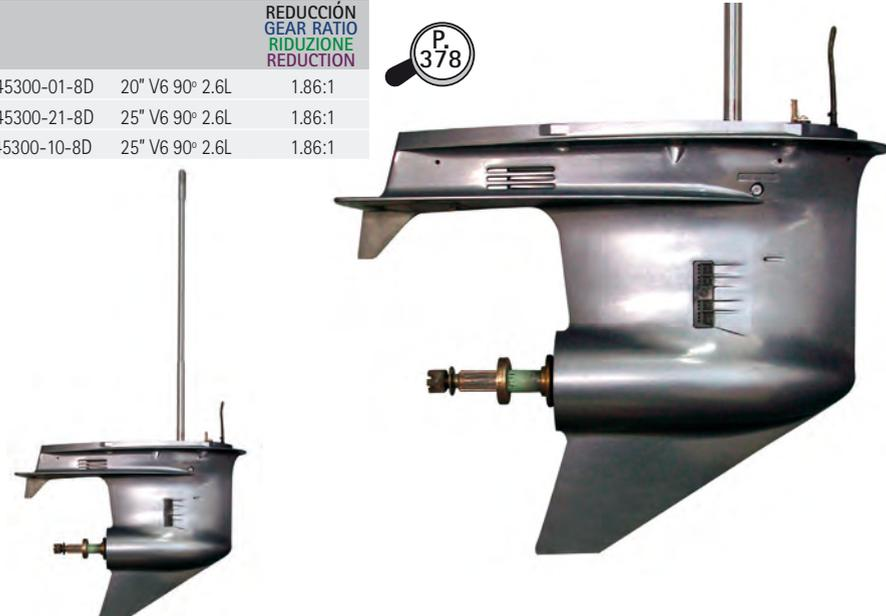

P. 378

STD	OEM		REDUCCIÓN GEAR RATIO RIDUZIONE REDUCTION
REC416-B20	64K-45300-02-NA	20" V6 90° 2.6L	2.0:1

 150HP (1987+)  
 175HP (1989+)  
 200HP (1989+)  
 225HP (1992+)



STD	CONTRAROTACIÓN COUNTERROTATION CONTROROTANTE CONTRE ROTATION	OEM		REDUCCIÓN GEAR RATIO RIDUZIONE REDUCTION	
REC421-A20		66K-45300-12-NA	20" V6 76° 3.1L / 3.2 L	1.81	
REC421-A25		60V-45300-20-8D	25" V6 76°	1.81	
		REC428-A25	60W-45300-20-8D	25" V6 90° 3.1L / 3.2 L	1.81

 V6  
 250D / DETO / DETOX / TR / TXR

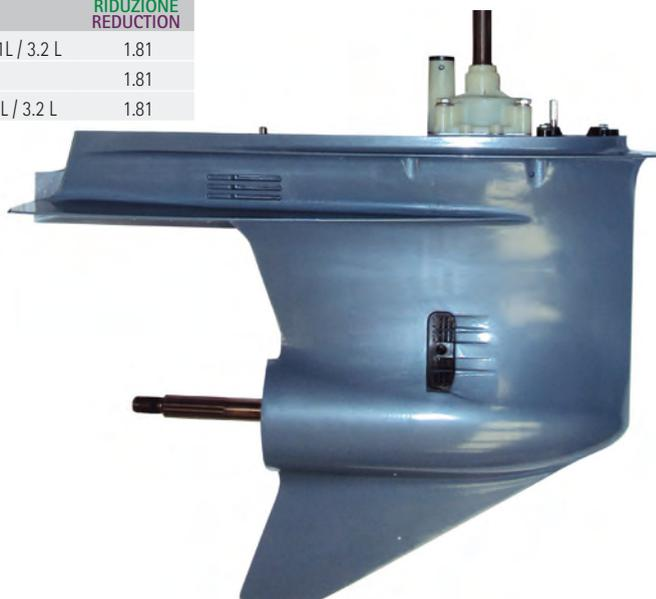

DESPIECE COLAS  
4 TIEMPOS

GEAR CASE PARTS  
4 STROKES

PARTI PIEDI  
DE 4 TEMPI

PIECES D'EMBASES  
DE 4 TEMPS

4T F2.5 (2003+)  
STROKES

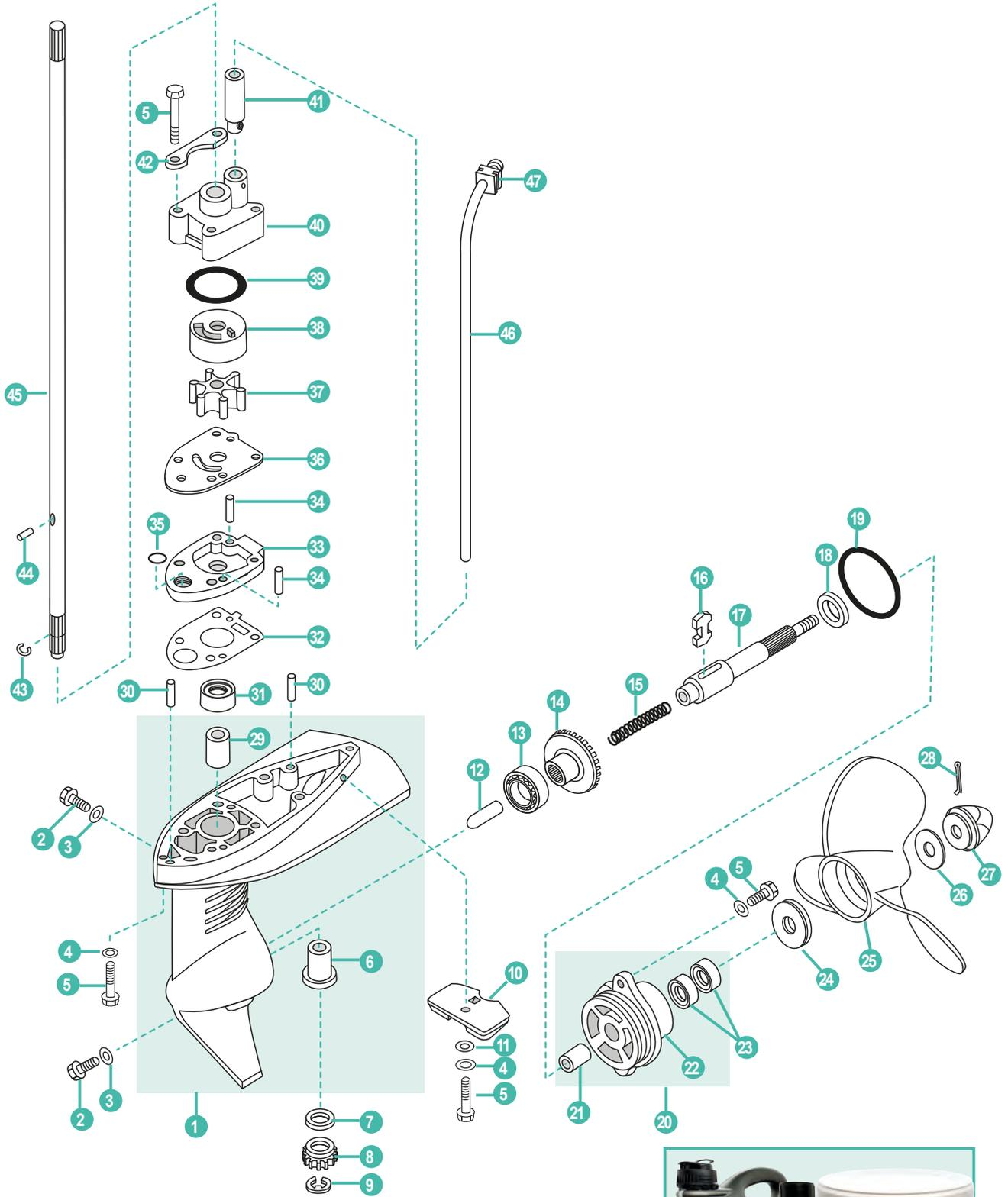

REC80W90U3  
REC80W90U6  
REGREU1  
REGREU12

P 43

YAMAHA

RECAMBIOS  
MARINOS

	REF	OEM				
	PAF2.6-03020000L	69M-G5300-01-4D	COLA COMPLETA L	COMPLETE GEAR HOUSING L	PIEDE COMPLETO L	EMBASE COMPLETE L
	PAF2.6-03020000S	69M-G5300-00-4D	COLA COMPLETA S	COMPLETE GEAR HOUSING S	PIEDE COMPLETO S	EMBASE COMPLETE S
1	PAF2.6-03000001	69M-G5311-00-4D	CARCASA	LOWER CASING	CARASSA	CARTER D'EMBASE
2	REC90340-08002	90340-08002	TAPÓN ACEITE	PLUG, OIL	TAPPO OLIO	BOUCHON REMPLISSAGE D'HUILE
3	REC90430-08020	90430-08020	JUNTA	GASKET	GUARNIZIONE	JOINT
4	PAGB/T97.1-8	97595-06520	ARANDELA	WASHER	RONDELLA	RONDELLE
5	PAGB/T5783-M5X12	95895-06020	TORNILLO	BOLT	VITE	VIS
6	PAF2.6-03000002	6L5-45317-09	COJINETE	BEARING	CUSCINETTO	PALIER
7	PAF2.6-03000017	6L5-45533-00-20	GRUESO (2.0mm)	SHIM (2.0mm)	SPESSORE (2.0mm)	CALE (2.0mm)
8	PAF2.6-03000018	6L5-45551-00	PIÑÓN ATAQUE	INITIATIVE GEAR	PIGNONE	PIGNON D'ATTAQUE
9	PAGB/T896-86	99001-06600	CIRCLIP	CIRCLIP	CIRCLIP	CIRCLIP
10	PAF4-03000022	68D-G5251-00	ÁNODO	ANODE	ANODO	ANODE
11	PAGB/T861.1-87	92990-06300	ARANDELA	WASHER	RONDELLA	RONDELLE
12	PAF2.6-03000020	69M-G5635-00	TAPÓN CAMBIO	PLUG, SHIFT	TAPPO	BOUCHON
13	PANTN16003EY	93316-003Y0	COJINETE	BEARING	CUSCINETTO	PALIER
14	PAF2.6-03000019	6L5-45560-00	PIÑÓN MARCHA AVANTE	POSITIVE GEAR ASSY	PIGNONE MARCIA AVANTI	PIGNON DE MARCHÉ AVANT
15	PAF4-03030003	90501-10064	MUELLE	SPRING, CLUTCH BLOCK	MOLLA	RESSORT
16	PAF2.6-03000202	6L5-45631-00	SELECTOR	CLUTCH BLOCK	SELETTORE	SELECTEUR
17	PAF2.6-03000201	6L5-45631-00	EJE HÉLICE	SHAFT, PROPELLER	ASSE ELICA	ARBRE D'HELICE
18	PAF2.6-03000021	90201-13198	ARANDELA	WASHER	RONDELLA	RONDELLE
19	PAJISB2401P48	93210-48214	TÓRICA	O-RING	O-RING	JOINT TORIQUE
20	PAF2.6-03000300	69M-G5361-00-4D	TAPA CARTER COMPLETA	COVER ASSY, LOWER CASING	COPERCHIO DE CARTER COMPLETO	DIABOLO COMPLET
21	PAF2.6-03000302		COJINETE CAMISA	BEARING, SLEEVE	CUSCINETTO ASSE	BAGUE
22	PAF2.6-03000301	69M-G5361-00-4D	TAPA CARTER	COVER, LOWER CASING	COPERCHIO CARTER	DIABOLO
23	PAF4-03050002	93101-13M12	RETÉN DE ACEITE	OIL SEAL	PARAOLIO	JOINT SPI
24	PAF4-03000025	68D-G5978-00	ESPACIADOR	SPACER	SPESSORE	ENTRETOISE
25	PAF2.6-03010000	6L5-45943-00-EL	HÉLICE	PROPELLER ASSY	ELICHE	HELICE
26	PAF4-03000026	90201-08M54	ARANDELA	WASHER	RONDELLA	RONDELLE
27	PAF4-03080000	6L5-45616-00	TUERCA	LOCK NUT	DADO	ÉCROU
28	PAGB/T91-1.6X12	91490-25030	PASADOR ALETAS	PIN, COTTER	SPINOTTO	LEVIER
29	PAF2.6-03000003	6L5-45316-09	COJINETE	BEARING	CUSCINETTO	PALIER
30	PAF15-00000013	93604-12M07	PASADOR	PIN	SPINOTTO	LEVIER
31	PAF2.6-03000004	93103-09M41	RETÉN DE ACEITE	OIL SEAL	PARAOLIO	JOINT D'HUILE
32	PAF2.6-03000007	69M-G5315-A0	JUNTA	GASKET, WATER PUMP	GUARNIZIONE	JOINT
33	PAF2.6-03000008	69M-G5321-00-94	CUERPO BOMBA	HOUSING, WATER PUMP	CORPO POMPA ACQUA	CORPS DE POMPE À EAU
34	PAF4-03000013	93604-18080	PASADOR	PIN	SPINOTTO	LEVIER
35	PAF2.6-03000009	93210-05001	TÓRICA	O-RING	O-RING	JOINT TORIQUE
36	PAF2.6-03000010	69M-G4323-00	PLACA	OUT PLATE	PIASTRA	PLAQUE
37	PAF2.6-03000100	6L5-44352-00	TURBINA	IMPELLER	GIRANTE	TURBINE
38	PAF2.6-03000015	6L5-44322-00	TAPA BOMBA AGUA	COVER, INNER WATER PUMP	TAPPO	COUVERCLE DE POMPE D'EAU
39	PAJASOF404-19-033	93210-33M85	TÓRICA	O-RING	O-RING	JOINT TORIQUE
40	PAF2.6-03000014	69M-G4311-00	CUERPO BOMBA	WATER PUMP HOUSING	CORPO POMPA ACQUA	CORPS DE POMPE À EAU
41	PAF4-03000021	6R0-44366-00	TUBO BOMBA AGUA	RUBBER TUBE, WATER PUMP	TUBO POMPA ACQUA	TUBE DE POMPE À EAU
42	PAF2.6-03000016	69M-G4328-00	PLATO BOMBA DE AGUA	PLATE, WATER PUMP FIXED	PIASTRA	PLAQUE, POMPE D'EAU
43	PAF2.6-03000012	93440-08819	CIRCLIP	CIRCLIP	CIRCLIP	CIRCLIP
44	PAF2.6-03000013	93604-07M13	PASADOR	PIN	SPINOTTO	LEVIER
45	PAF2.6-03000011S	69M-G5511-00	EJE VERTICAL S	DRIVE SHAFT S	ASSE VERTICALE S	ARBRE DE COMMANDE S
	PAF2.6-03000011L	69M-G5511-10	EJE VERTICAL L	DRIVE SHAFT L	ASSE VERTICALE L	ARBRE DE COMMANDE L
46	PAF2.6-02000003S	69M-44361-00	TUBO DE AGUA S	WATER TUBE S	TUBO DELL'ACQUA S	DURITE D'EAU S
	PAF2.6-02000003L	69M-44361-10	TUBO DE AGUA L	WATER TUBE L	TUBO DELL'ACQUA L	DURITE D'EAU L
47	PAF4-02040002	68D-G4365-00	GOMA DEL TUBO DE AGUA	I-SHAPED RUBBER BAND	GOMMA TUBO ACQUA	PLOT CAOUTCHOUC DE TUBE D'EAU



	REF	OEM				
	PAF4-0310000L	68D-G5300-10-4D	COLA COMPLETA L	COMPLETE GEAR HOUSING L	PIEDE COMPLETO L	EMBASE COMPLETE L
	PAF4-0310000S	68D-G5300-00-4D	COLA COMPLETA S	COMPLETE GEAR HOUSING S	PIEDE COMPLETO S	EMBASE COMPLETE S
1	PAF4-03000001	68D-G5300-11-4D	CARCASA MOTOR	CRANK CASE	CARCASSA	CARTER D'EMBASE
2	REC90340-08002	90340-08002	TAPÓN ACEITE	PLUG, OIL	TAPPO OLIO	BOUCHON REMPLISSAGE D'HUILE
3	REC90430-08020	90430-08020	JUNTA	GASKET	GUARNIZIONE	JOINT
4	PAGB/T5782-M6X125	97013-06035	TORNILLO HEXAGONAL L	HEXAGON BOLT L	VITE L	VIS L
	PAGB/T5782-2000S	PAGB/T5782-2000S	TORNILLO HEXAGONAL S	HEXAGON BOLT S	VITE S	VIS S
5	PAF4-03000003	6E0-45316-09	RODAMIENTO	BALL BEARING	CUSCINETTO	ROULEMENT À BILLE
6	PAF4-03000002	6E0-45317-09	COJINETE	BEARING	CUSCINETTO	PALIER
7	PAF4-03000006	90204-11M49	ARANDELA	WASHER	RONDELLA	RONDELLE
8	PAF4-03000007	6E0-45551-00	PIÑÓN ATAQUE	INITIATIVE GEAR	MARCIA INIZIATIVA	PIGNON D'ATTAQUE
9	PAGB/T896-86	99001-06600	CIRCLIP	CIRCLIP	CIRCLIP	CIRCLIP
10	PAF4-03000022	68D-G5251-00	ÁNODO	ANODE	ANODO	ANODE
11	PAF4-03000008	67D-45635-00	ÉMBOLO	PLUGER, SHIFT	BULLONE	BOUCHON
12	PAF4-03010000	67D-45560-00	PIÑÓN MARCHA AVANTE	POSITIVE GEAR ASSY	PIGNONE MARCIA AVANTI	PIGNON DE MARCHE AVANT
13	PAF4-03030002	67D-45631-01	SELECTOR	CLUTCH BLOCK	SELETTORE	SELECTEUR
14	PAF4-03040000	67D-45570-00	PIÑÓN MARCHA ATRÁS	REVERSE GEAR	PIGNONE MARCIA INDIETRO	PIGNON MARCHE ARRIÈRE
15	PAF4-03050002	93101-13M12	RETÉN DE ACEITE	OIL SEAL	PARAOLIO	JOINT SPI
16	PAJISB2401P48	93210-48214	TÓRICA	O-RING	O-RING	JOINT TORIQUE
17	PAF4-03050001	68D-G5361-00-4D	TAPA CÁRTER	COVER, LOWER CASING	TAPPO CARTER	DIABOLO
18	PAGB/T5783-M5X12	95895-06016-00	TORNILLO HEXAGONAL	HEXAGON BOLT	VITE ESSAGONALE	VIS HEXAGONAL
19	PAF4-03000025	68D-G5987-00	ESPACIADOR	SPACER	DISTANZIALE	ENTRETOISE
20	PAF4-03070000	6E0-45943-01-EL	HÉLICE	PROPELLER	ELICHE	HELICE
21	PAF4-03000026	90201-08M54	ARANDELA INOX.	WASHER, STAINLESS STEEL	RONDELLA INOX.	RONDELLE INOX
22	PAF4-03080000	6L5-45616-00	TUERCA	LOCK NUT	DADO	ÉCROU
23	PAGB/T91-1.6X12	91490-25030	PASADOR ALETAS	PIN, COTTER 2.5x30	PIN	PIN
24	PAF4-00000001	90387-06806	PASADOR VACÍO	HOLLOW PIN	SPINOTTO	GUIDE
25	PAF4-03000027	93101-10M14	RETÉN DE ACEITE	OIL SEAL	PARAOLIO	JOINT SPI
26	PAF4-03000011	68D-G5315-A0	JUNTA HERMÉTICA BASE	HERMETIC GASKET, WATER PUMP BASE	GUARNIZIONE BASE POMPA ACQUA	JOINT DE BASE DE POMPE À EAU
27	PAF4-03000012	68D-G5321-00	BASE BOMBA AGUA	BASE, WATER PUMP	BASE POMPA	BASE DE POMPE À EAU
28	PAF4-03000015	6E0-44323-00	PLACA	OUT PLATE	PIASTRA	PLAQUE
29	PAF4-03060000	6E0-44352-00	TURBINA BOMBA AGUA	IMPELLER, WATER PUMP	GIRANTE POMPA	TURBINE, POMPE D'EAU
30	PAF4-03000017	6E0-44322-02	TAPA, BOMBA AGUA	COVER, INNER WATER PUMP	COPERCHIO, POMPE D'EAU	COUVERCLE, POMPE D'EAU
31	PAF4-03000018	68D-G4315-A0	JUNTA TAPA BOMBA AGUA	GASKET, WATER PUMP COVER	GUARNIZIONE COPERCHIO	JOINT COUVERCLE
32	PAF4-03000013	93604-18080	PASADOR BOMBA AGUA	PIN, WATER PUMP	SPINOTTO POMPA ACQUA	LEVIER POMPE D'EAU
33	PAF4-03000019	68D-G4311-01	CUERPO BOMBA AGUA	HOUSING, WATER PUMP	CORPO POMPA	LOGEMENT POMPE D'EAU
34	PAF4-03000021	67D-44366-00	TUBO GOMA BOMBA AGUA	RUBBER TUBE, WATER PUMP	TUBO IN GOMMA, POMPA	DURITE DE COUTCHOU
35	PAF4-03000020	68D-G4328-00	PLCA BOMBA AGUA	PLATE, WATER PUMP FIXED	PIASTRA POMPA	PLAQUE, POMPE D'EAU
36	PAF4-03000005	90467-08M01	CLIP	CLIP	CLIP	CLIP
37	PAF4-03000016	93604-09066	PASADOR	PIN	SPINOTTO	LEVIER
38	PAF4-03000004L	6E0-45511-11	EJE VERTICAL S	DRIVE SHAFT S	ASSE VERTICALE S	ARBRE DE COMMANDE S
	PAF4-03000004S	6E0-45511-01	EJE VERTICAL L	DRIVE SHAFT L	ASSE VERTICALE L	ARBRE DE COMMANDE L
39	PAF4-02040001	68D-G4360-10	TUBO DE AGUA S	WATER TUBE S	TUBO DELL'ACQUA S	DURITE D'EAU S
	PAF4-02040001S	68D-G4360-00	TUBO DE AGUA L	WATER TUBE L	TUBO DELL'ACQUA L	DURITE D'EAU L
40	PAF4-02040002	68D-G4365-00	GOMA DEL TUBO DE AGUA	I-SHAPED RUBBER BAND	GOMMA TUBO ACQUA	PLOT CAOUTCHOU DE TUBE D'EAU
41	PAF4-03020000L	68D-G4150-10	VARILLA SELECTOR L	CAM ASSY, SHIFT ROD L	ASTICELLA CAMBIO L	LEVIER DE VITESSE L
	PAF4-03020000S	68D-G4150-00	VARILLA SELECTOR S	CAM ASSY, SHIFT ROD S	ASTICELLA CAMBIO S	LEVIER DE VITESSE S



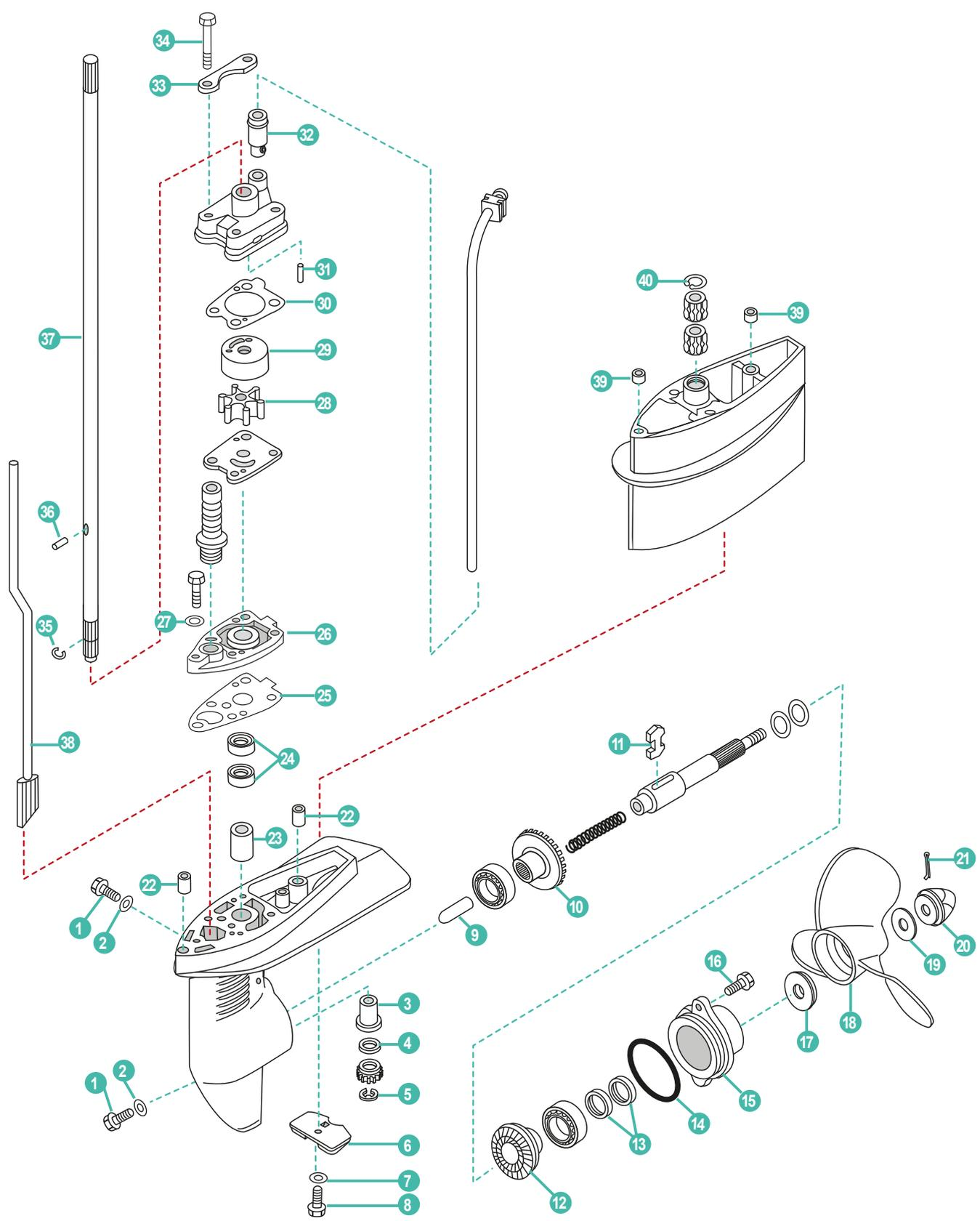



	REF	OEM				
1	REC90340-08002	90340-08002	TORNILLO DRENAJE	BOLT, DISCHARGING OIL	VITE DRENAGGIO	BOUCHON DE VIDANGE
2	REC90430-08020	90430-08020	JUNTA	GASKET	GUANIZIONE	JOINT
3	PAF4-03000002	6E0-45317-09	COJINETE	BEARING	CUSCINETTO	PALIER
4	PAF4-03000006	90201-11M49	ARANDELA	WASHER	RONDELLA	RONDELLE
5	REC99001-06600	99001-06600	CIRCLIP	CIRCLIP	CIRCLIP	CIRCLIP
6	CM6L5-45251-02A	68D-G5251-00	ÁNODO	ANODE	ANODO	ANODE
7	PAGB/T861.1-87	92990-06300	ARANDELA	WASHER	RONDELLA	RONDELLE
8	PAGB/T5783-M6X14	95895-06012	TORNILLO	SCREW	VITE	VIS
9	PAF4-03000008	67D-45635-00	ÉMBOLO	PLUGER, SHIFT	BULLONE	AXE DE VERROUILLAGE DU CRABOT
10	PAF4-03010000	67D-45560-00	PIÑÓN MARCHA AVANTE	POSITIVE GEAR ASSY	PIGNONE MARCIA AVANTI	PIGNON DE MARCHÉ AVANT
11	PAF4-03030002	67D-45631-01	SELECTOR	CLUTCH BLOCK	SELETTORE	BLOQUEUR
12	PAF4-03040000	67D-45570-00	PIÑÓN MARCHA ATRÁS	REVERSE GEAR	PIGNONE MARCIA INDIETRO	PIGNON MARCHÉ ARRIÈRE
13	REC93101-13M12	93101-13M12	RETÉN DE ACEITE	OIL SEAL	PARAOLIO	JOINT SPI
14	REC93210-48214	93210-48214	TÓRICA	O-RING	O-RING	JOINT TORIQUE
15	PAF4-03050001	68D-G5361-00-4D	TAPA CÁRTER	COVER, LOWER CASING	COPERCHIO CARTER	DIABOLO
16	PAGB/T5783-M5X12	95895-06016	TORNILLO HEXAGONAL	HEXAGON BOLT M6x18	VITE	VIS
17	PAF4-03000025	68D-G5987-00	ESPACIADOR	SPACER	DISTANZIALE	ENTRETOISE
18	PAF4-03070000	6E0-45943-01	HÉLICE	PROPELLER	ELICHE	HELICE
18	PAF2.6-03010000	6E0-45949-00	HÉLICE	PROPELLER	ELICHE	HELICE
19	PAF4-03000026	90201-08M54	ARANDELA INOX.	WASHER, STAINLESS STEEL	RONDELLA INOX.	RONDELLE INOX
20	PAF4-03080000	6L5-45646-00	TUERCA	LOCK NUT	DADO	ÉCROU
21	PAGB/T91-1.6X12	91490-25030	PASADOR ALETAS	PIN, COTTER 2.5x30	PIN	PIN
22	PAF4-00000001	90387-06806	ESPACIADOR	SPACER	DISTANZIALE	ENTRETOISE
23	PAF4-03000003	6E0-45316-09	RODAMIENTO	BALL BEARING	CUSCINETTO	ROULEMENT À BILLE
24	PAF4-03000027	93101-10M14	RETÉN DE ACEITE	OIL SEAL	PARAOLIO	JOINT SPI
25	PAF4-03000011	68D-G5315-A0	JUNTA BASE	GASKET, WATER PUMP BASE	GUARNIZIONE BASE POMPA ACQUA	JOINT DE POMPE À EAU
26	PAF4-03000012	68D-G5321-00	PLACA	OUT PLATE	PIASTRA	PLAQUE
27	PAGB/T97.1-6	92995-06600	ARANDELA	WASHER	RONDELLA	RONDELLE
28	REC6E0-44352-00	6E0-44352-00	TURBINA BOMBA AGUA	IMPELLER, WATER PUMP	GIRANTE POMPA	TURBINE DEPOMPE À EAU
29	PAF6-03000002	6BX-44322-00	TAPA, BOMBA AGUA	COVER, INNER WATER PUMP	COPERCHIO, POMPE ACQUA	INSERT DE POMPE À EAU
30	PAF4-03000018	6BX-G4315-01	JUNTA TAPA BOMBA AGUA	GASKET, WATER PUMP COVER	GUARNIZIONE COPERCHIO	JOINT COUVERCLE
31	PAF4-03000013	93604-18080	PASADOR BOMBA AGUA	PIN, WATER PUMP	SPINOTTO POMPA ACQUA	PIN DE POMPE À EAU
32	PAF4-03000021	67D-44366-00	TUBO GOMA BOMBA AGUA	RUBBER TUBE, WATER PUMP	TUBO IN GOMMA, POMPA	DURITE COUTCHOUÇ
33	PAF4-03000020	68D-G4328-00	PLCA BOMBA AGUA	PLATE, WATER PUMP FIXED	PIASTRA POMPA	PLAQUE ,POMPE À EAU
34	REC97095-06045	97095-06045	TORNILLO	SCREW	VITE	VIS
35	PAF4-03000005	90467-08M01	CLIP	CLIP	CLIP	CLIP
36	PAF4-03000016	93604-09066	PASADOR	PIN	SPINOTTO	CLAVETTE
37	PAF4-03000004S	68D-G5511-00	EJE VERTICAL S	DRIVE SHAFT S	ASSE VERTICALE S	ARBRE DE COMMANDE S
37	PAF4-03000004L	68D-G5511-10	EJE VERTICAL L	DRIVE SHAFT L	ASSE VERTICALE L	ARBRE DE COMMANDE L
38	PAF4-03020000S	6BX-G4150-00	EJE LEVA COMPLETO S	CAM ASSY, SHIFT ROD S	ASSE LEVA COMPLETO S	LEVIER DE VITESSE S
38	PAF4-03020000L	6BX-G4150-10	EJE LEVA COMPLETO L	CAM ASSY, SHIFT ROD L	ASSE LEVA COMPLETO L	LEVIER DE VITESSE L
39	PAF4-00000001	90387-06806	ESPACIADOR	SPACER	DISTANZIALE	ENTRETOISE
40	PAGB/T893.1-22	93420-22M03	SEGURO	CLAMP	BLOCCAGGIO	CLAVETTE



REC80W90U3  
REC80W90U6  
RECGREU1  
RECGREU12

P. 43

4T F6A/M • F8C/M/F • F9.9F/J

STROKES

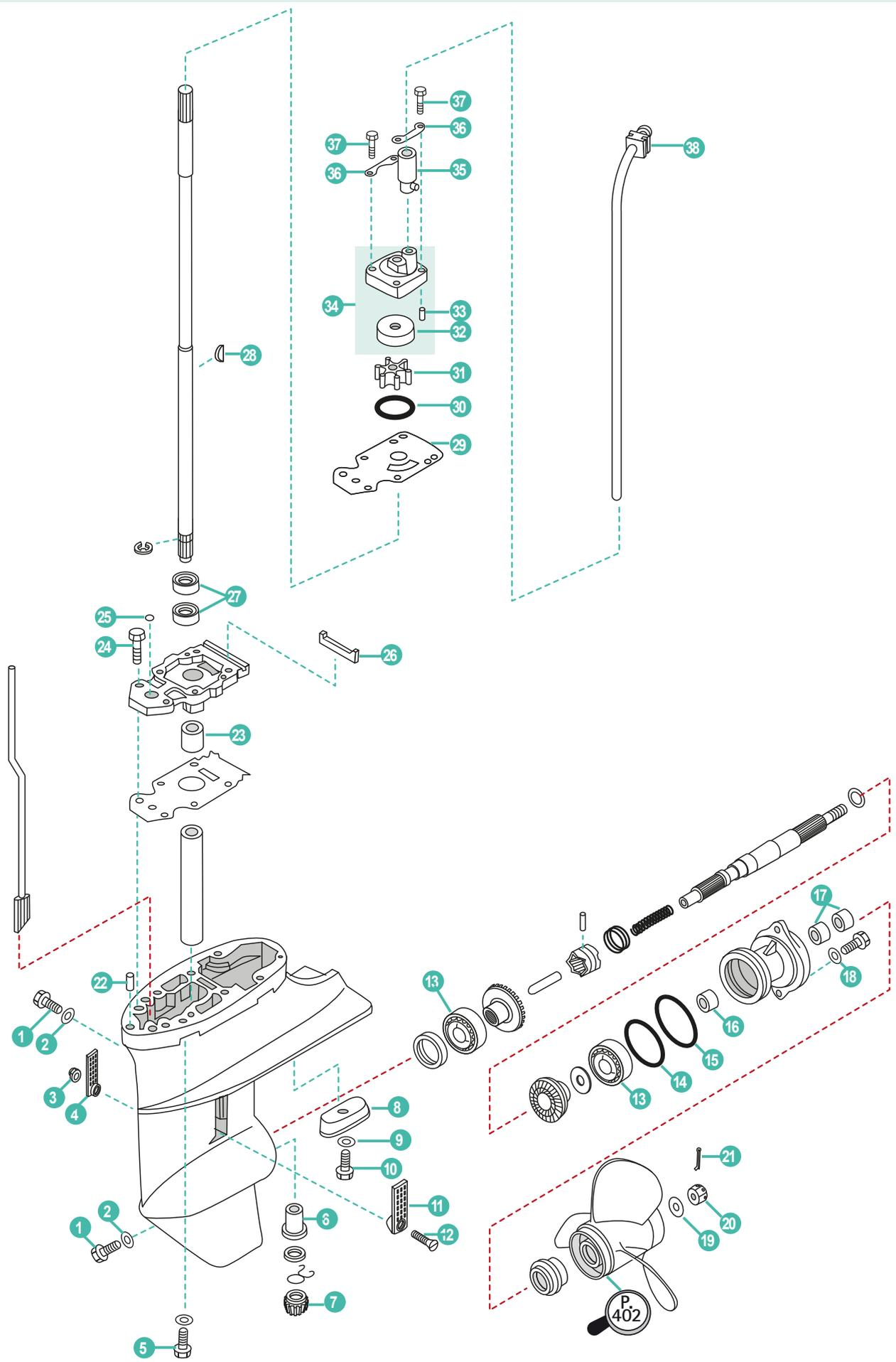

	REF	OEM				
1	REC90340-08002	90340-08002	TORNILLO DRENAJE	BOLT, DISCHARGING OIL	VITE DRENAGGIO	BOUCHON DE VIDANGE
2	REC90430-08020	90430-08020	JUNTA	GASKET	GUANIZIONE	JOINT
3	PAGB/T6182-M5	90185-05002	TUERCA AUTOBLOCANTE	NUT LOCKING M5	DADO CHIUSURA M5	ECROU FREIN M5
4	PAF15-06000002	6G1-45215-00	CUBIERTA ENTRADA DE AGUA 2	WATER INLET 2	COPERCHIO ENTRATA ACQUA 2	GRILLE D'ENTREE D'EAU 2
5	PAGB/T5783-M8X35	97075-08035	PERNO	STUD	BULLONE	BOULON
6	REC6G1-45317-09	6G1-45317-09	RODAMIENTO	BALL BEARING	CUSCINETTO	ROULEMENT À BILLE
7	REC68T-45551-00	6N0-G5551-A0	PIÑÓN ATAQUE	INITIATIVE GEAR	MARCIA INIZIATIVA	PIGNON D'ATTAQUE
8	CM68T-45251-00A	68T-45251-00	ÁNODO	ANODE	ANODO	ANODE
9	PAGB/T861.1-87	92990-06300	ARANDELA	WASHER	RONDELLA	RONDELLE
10	PAGB/T5783-M5X12	95895-06016	TORNILLO	SCREW	VITE	VIS
11	PAF15-06000003	6G1-45214-00	CUBIERTA ENTRADA DE AGUA 1	WATER INLET 1	COPERCHIO ENTRATA ACQUA 1	GRILLE D'ENTREE D'EAU 1
12	PAGB/T820-M5X25	90152-05M03	TORNILLO	SCREW	VITE	VIS
13	PAGB/T276-6004C2	93306-004YH	COJINETE	BEARING	CUSCINETTO	PALIER
14	REC93210-49046	93210-49046	TÓRICA	O-RING	O-RING	JOINT TORIQUE
15	REC93210-53M08	93210-53M08	TÓRICA	O-RING	O-RING	JOINT TORIQUE
16	REC6G1-45362-09	6G1-45362-09	RODAMIENTO	BALL BEARING	CUSCINETTO	ROULEMENT À BILLE
17	REC93101-15074	93101-15074	RETÉN DE ACEITE	OIL SEAL	PARAOLIO	JOINT SPI
18	PAGB/T97.1-6	92995-06600	ARANDELA	WASHER	RONDELLA	RONDELLE
19	REC90201-10M01	90201-10M01	ARANDELA	WASHER	RONDELLA	RONDELLE
20	REC90171-10M01	90171-10M01	TUERCA	LOCK NUT	DADO	ÉCROU
21	REC91490-30025	91490-30020	PASADOR ALETAS	PIN, COTTER	PIN	GOUPILLE
22	PAF15-00000013	93604-12M07	PIN CENTRADOR	HOLLOW PIN	SPINOTTO DI CENTRAGGIO	PIN DE CENTRAGE
23	REC6G1-45316-09	6G1-45316-09	RODAMIENTO	BALL BEARING	CUSCINETTO	ROULEMENT À BILLE
24	PAGB/T5783-M8X25	97080-08025	PERNO	STUD	BULLONE	BOULON
25	REC93210-06ME6	93210-06ME6	TÓRICA	O-RING	O-RING	JOINT TORIQUE
26	PAF15-06020005	63V-45375-00	RETÉN DE GOMA	SEAL, RUBBER	TENUTA IN GOMMA	JOINT DE COUTCHOU
27	REC93101-11M23	93101-11M23	RETÉN DE ACEITE	OIL SEAL	PARAOLIO	JOINT SPI
28	REC664-44338-00	664-44338-00	CUÑA	KEY WOODRUFF	CHIAVETTA	CLAVETTE
29	REC68T-44323-00	68T-44323-00	JUNTA TAPA BOMBA AGUA	GASKET, WATER PUMP COVER	GUARNIZIONE COPERCHIO	JOINT COUVERCLE
30	REC93210-44398	93210-44398	TÓRICA	O-RING	O-RING	JOINT TORIQUE
31	REC68T-44352-00	68T-44352-00	TURBINA BOMBA AGUA	IMPELLER, WATER PUMP	GIRANTE POMPA	TURBINE DE POMPE À EAU
32	REC63V-44322-00	63V-44322-00	TAPA, BOMBA AGUA	COVER, INNER WATER PUMP	COPERCHIO, POMPE ACQUA	COUVERCLE, POMPE À EAU
33	PAF15-00000013	93604-12M07	PIN CENTRADOR	HOLLOW PIN	SPINOTTO DI CENTRAGGIO	PIN DE CENTRAGE
34	REC63V-44301-00	63V-44301-00	CUERPO BOMBA AGUA	HOUSING, WATER PUMP	CORPO POMPA	CORPS DE POMPE À EAU
35	REC68T-44366-00	68T-44366-00	TUBO GOMA BOMBA AGUA	RUBBER TUBE, WATER PUMP	TUBO IN GOMMA, POMPA	DURITE COUTCHOU
36	PAF15-06000014	63V-44328-00	PLACA	OUT PLATE	PIASTRA	PLAQUE
37	REC97080-08045	97080-08045	PERNO	STUD	BULLONE	BOULON
38	PAF15-02000006	63V-44365-10	GOMA DEL TUBO DE AGUA	I-SHAPED RUBBER BAND	GOMMA TUBO ACQUA	PLOT CAOUTCHOU DE TUBE D'EAU



REC80W90U3  
REC80W90U6  
RECGREU1  
RECGREU12

P. 43



REF OEM  
REC68T-W0001-20 68T-W0001-20

P. 144



REF OEM  
REC68T-W0078-00 68T-W0078-00

P. 150

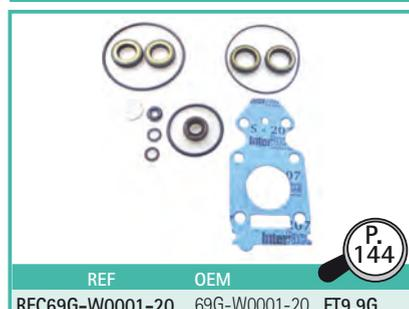

REF OEM  
REC69G-W0001-20 69G-W0001-20 FT9.9G

P. 144

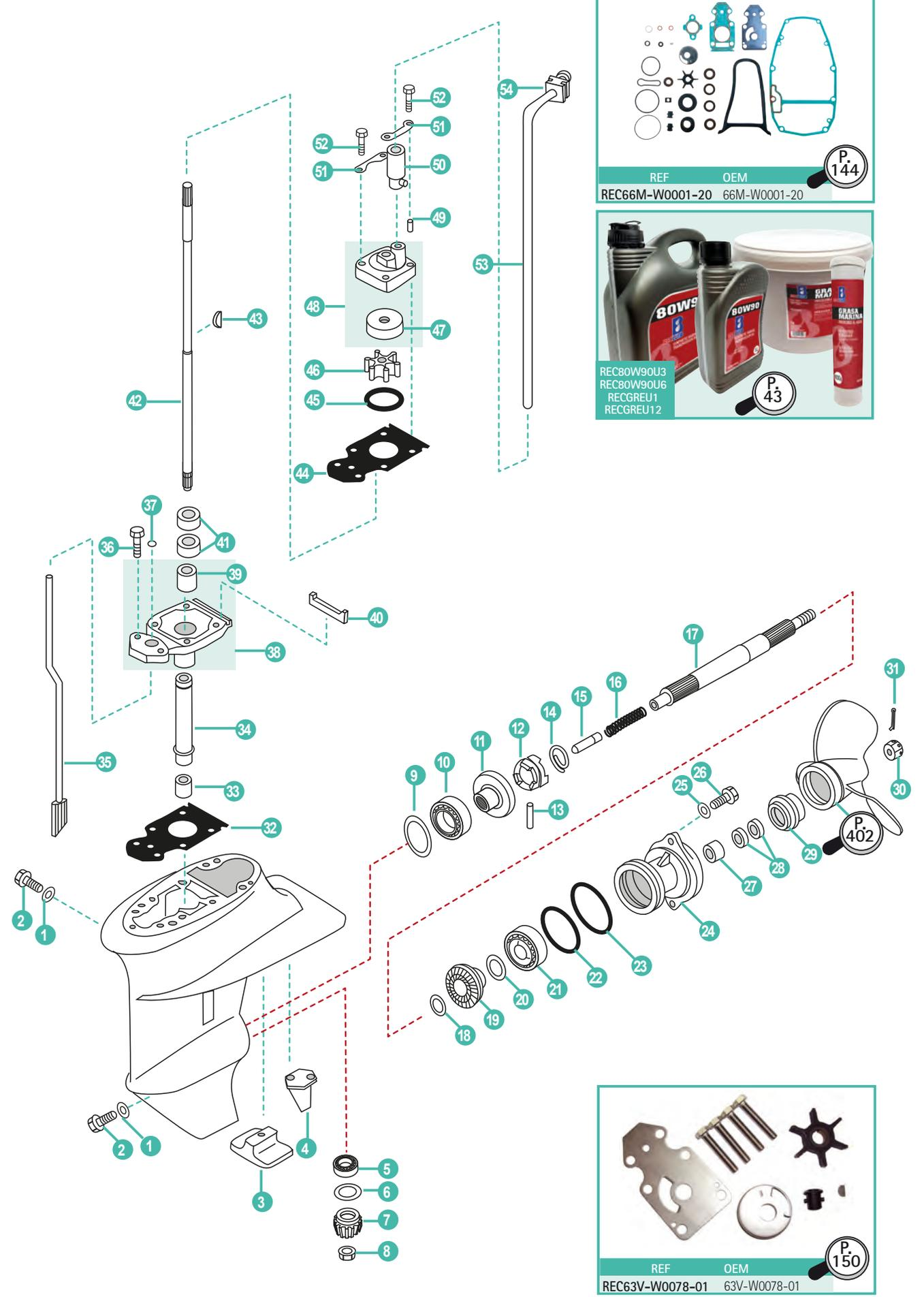

REF	OEM
REC66M-W0001-20	66M-W0001-20

P. 144

REC80W90U3  
REC80W90U6  
RECGRU1  
RECGRU12

P. 43

REF	OEM
REC63V-W0078-01	63V-W0078-01

P. 150

	REF	OEM				
	PAF15-06100000L	66M-45300-11-4D	COLA COMPLETA L	COMPLETE GEAR HOUSING L	PIEDE COMPLETO L	EMBASE COMPLETE L
	PAF15-06100000S	66M-45300-02-4D	COLA COMPLETA S	COMPLETE GEAR HOUSING S	PIEDE COMPLETO S	EMBASE COMPLETE S
1	REC90430-08020	90430-08020	ARANDELA	WASHER	RONDELLA	RONDELLE
2	REC90340-08002	90340-08002	TAPÓN ACEITE	PLUG, OIL	TAPPO OLIO	BOUCHON REMPLISSAGE D'HUILE
3	CM61N-45251-01	61N-45251-01	ÁNODO	ANODE	ANODO	ANODE
4	CM66M-45371-00	66M-45371-00	ÁNODO TIMÓN	TAB-TRIM	ANODO TIMONE	ANODE
5	REC93341-214U1	93314-314V8	COJINETE	BEARING	CUSCINETTO	PALIER
6	PAF15-06000008	6E8-45587-10-13	GRUESO	SHIM	SPESSORE	CALE
7	REC63V-45551-00	63V-45551-00	PIÑÓN ATAQUE	INITIATIVE GEAR	MARCIA INIZIATIVA	PIGNON D'ATTAQUE
8	REC90179-08M06	90179-08M06	TUERCA	LOCK NUT	DADO	ÉCROU
9	PAF15-06000010-1	664-45567-01-10	GRUESO	SHIM	SPESSORE	CALE
10	REC93332-00005	93332-00005	COJINETE	BEARING	CUSCINETTO	PALIER
11	REC6E7-45560-01	6E7-45560-01	PIÑÓN MARCHA AVANTE	POSITIVE GEAR ASSY	PIGNONE MARCIA AVANTI	PIGNON DE MARCHÉ AVANT
12	REC682-45631-00	682-45631-00	SELECTOR	CLUTCH BLOCK	SELETTORE	SELECTEUR
13	REC90250-05010	90250-05010	PASADOR	PIN	SPINOTTO	LEVIER
14	REC648-45633-00	648-45633-00	MUELLE	SPRING	MOLLA	RESSORT
15	REC650-45635-00	650-45635-00	ÉMBOLO	PLUNGER	BULLONE	BOUCHON
16	PAF15-06070002	90501-14M06	MUELLE	SPRING	MOLLA	RESSORT
17	REC683-45611-00	683-45611-00	EJE HÉLICE	PROPELLER SHAFT	ASSE ELICA	ARBRE D'HELICE
18	REC90201-17682	90201-17682	ARANDELA	WASHER	RONDELLA	RONDELLE
19	REC6E7-45570-00	6E7-45571-00	PIÑÓN MARCHA ATRÁS	REVERSE GEAR	PIGNONE MARCIA INDIETRO	PIGNON MARCHÉ ARRIÈRE
20	PAF15-06080006-1	626-45577-00-01	GRUESO	SHIM	SPESSORE	CALE
21	REC93306-00501	93306-00501	COJINETE	BEARING	CUSCINETTO	PALIER
22	REC93210-57M09	93210-57M09	TÓRICA	O-RING	O-RING	JOINT TORIQUE
23	PAF15-06080003	93210-56M80	TÓRICA	O-RING	O-RING	JOINT TORIQUE
24	REC683-45361-01-4D	683-45361-02-4D	DIÁBOLO	CAP, LOWER CASING	COPERCHIO CARTER INFERIORE	DIABOLO
25	PAGB/T97.1-1-6	92995-06600	ARANDELA	WASHER	RONDELLA	RONDELLE
26	PAGB/T5783-M6X20	97095-06020	TORNILLO	SCREW	VITE	VIS
27	REC93315-317U2	93315-317U2	COJINETE	BEARING	CUSCINETTO	PALIER
28	REC93101-17054	93101-17054	RETÉN DE ACEITE	OIL SEAL	PARAOLIO	JOINT SPI
29	REC6E7-45987-00	6E7-45987-00	ESPACIADOR	SPACER	DISTANZIALE	ENTRETOISE
30	REC90171-10M01	90171-10M01	TUERCA	LOCK NUT	DADO	ÉCROU
31	REC91490-30025	91490-30020	PASADOR ALETAS	PIN, COTTER	PIN	GOUPILLE
32	REC63V-45315-A0	63V-45315-A0	JUNTA	GASKET	GUANIZIONE	JOINT
33	REC93315-314V8	93315-314V8	COJINETE	BEARING	CUSCINETTO	PALIER
34	PAF15-06000006	63V-45536-00	CAMISA EJE	SLEEVE, DRIVE	TUBO GUIDA	TUBE GUIDE
35	PAF15-06030000S	63V-44150-00	VARILLA SELECTOR S	CAM ASSY, SHIFT ROD S	ASTICELLA CAMBIO S	LEVIER DE VITESSE S
	PAF15-06030000L	63V-44150-10	VARILLA SELECTOR L	CAM ASSY, SHIFT ROD L	ASTICELLA CAMBIO L	LEVIER DE VITESSE L
36	PAGB/T5783-M8X25	97080-08025	TORNILLO	SCREW	VITE	VIS
37	REC93210-06ME6	93210-06ME6	TÓRICA	O-RING	O-RING	JOINT TORIQUE
38	REC63V-45331-00-5B	63V-45331-00-5B	CUERPO DEL COJINETE	SHELL, BEARING	CORPO DE CUSCINETTO	LOGEMENT DE PALIER
39	REC626-45316-09	626-45316-09	CASQUILLO EJE	BUSHER, SHAFT	GOMMINO ASSE	DOUILLE
40	PAF15-06020005	63V-45375-00	RETÉN DE GOMA	SEAL, RUBBER	TENUTA IN COMMA	JOINT DE COUTCHOU
41	REC93101-20048	93101-20048	RETÉN DE ACEITE	OIL SEAL	PARAOLIO	JOINT SPI
42	PAF15-06040000S	63V-45510-00	EJE VERTICAL S	DRIVE SHAFT S	ASSE VERTICALE S	ARBRE DE COMMANDE S
	REC63V-45501-10	63V-45510-11	EJE VERTICAL L	DRIVE SHAFT L	ASSE VERTICALE L	ARBRE DE COMMANDE L
43	REC664-44338-00	664-44338-00	CUÑA	KEY WOODRUFF	CHIAVETTA	CLAVETTE
44	REC63V-44323-00	63V-44323-00	JUNTA TAPA BOMBA AGUA	GASKET, WATER PUMP COVER	GUARNIZIONE COPERCHIO	JOINT COUVERCLE
45	REC93210-44398	93210-44398	TÓRICA	O-RING	O-RING	JOINT TORIQUE
46	REC63V-44352-01	63V-44352-01	TURBINA	IMPELLER	GIRANTE	TURBINE
47	REC63V-44322-00	63V-44322-00	TAPA, BOMBA AGUA	COVER, INNER WATER PUMP	COPERCHIO, POMPE DACQUA	INSERT DE POMPE À EAU
48	REC63V-44301-00	63V-44301-00	CUERPO DE BOMBA	PUMP HOUSING	CORPO POMPA	CORPS DE POMPE À EAU
49	PAF15-00000013	93604-12M07	PASADOR	PIN	SPINOTTO	PIN
50	REC647-44366-00	647-44366-00	TUBO GOMA BOMBA AGUA	RUBBER TUBE, WATER PUMP	TUBO IN GOMMA, POMPA	DURITE COUTCHOU
51	PAF15-06000014	63V-44328-00	PLACA	OUT PLATE	PIASTRA	PLAQUE
52	REC97080-08045	97080-08045	PERNO	STUD	BULLONE	BOULON
53	PAF15-02000005S	66M-44361-00	TUBO DE AGUA S	WATER TUBE S	TUBO DELL'ACQUA S	DURITE D'EAU S
	PAF15-02000005L	66M-44361-10	TUBO DE AGUA L	WATER TUBE L	TUBO DELL'ACQUA L	DURITE D'EAU L
54	PAF15-02000006	63V-44365-10	GOMA DEL TUBO DE AGUA	I-SHAPED RUBBER BAND	GOMMA TUBO ACQUA	PLOT CAOUTCHOU DE TUBE D'EAU

4T F9.9H • F13.5B • F15C/M/E • F20B/E/M  
STROKES

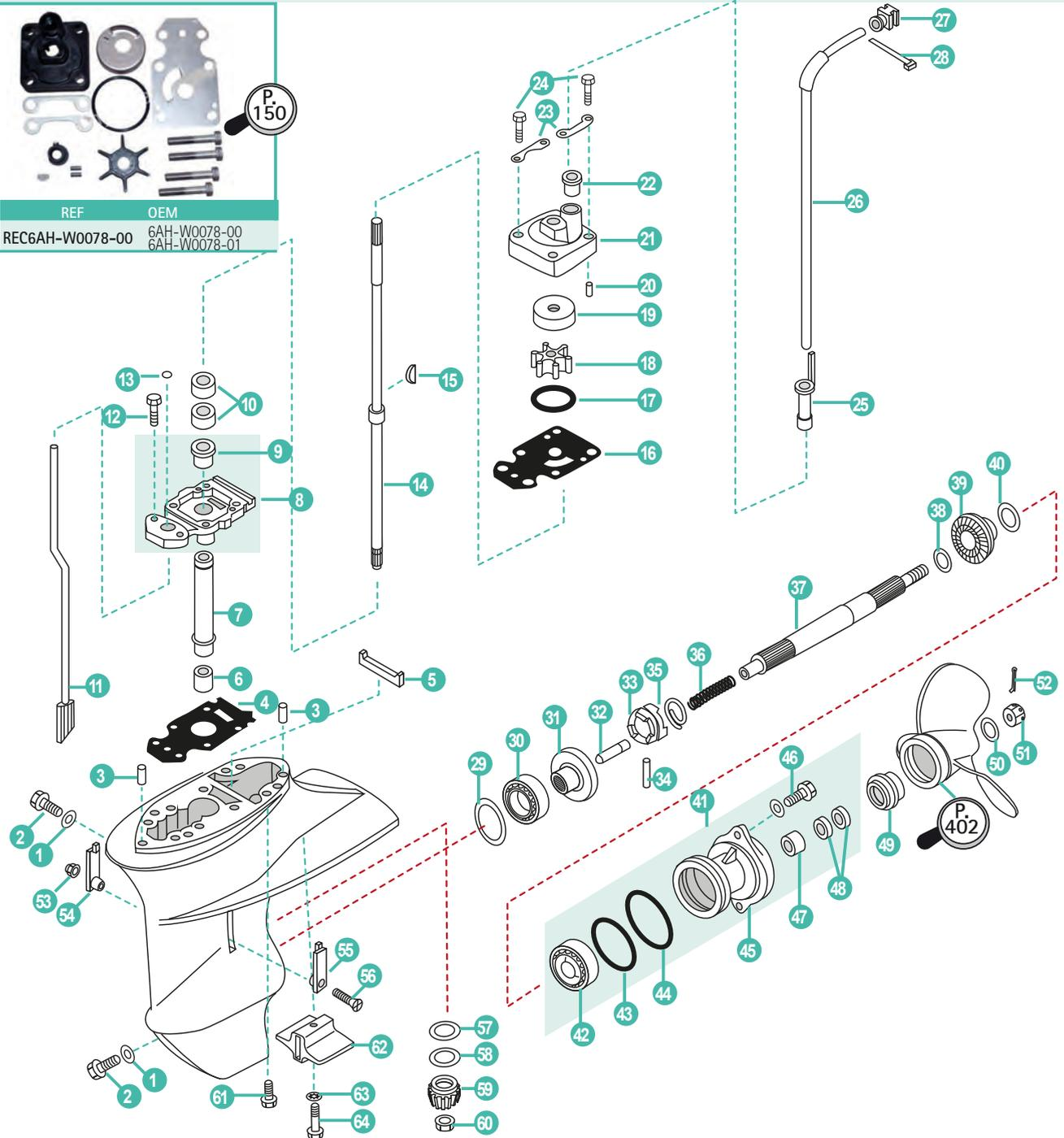

	REF	OEM				
	PAF20-04000000L	6AH-45300-10-8D	COLA COMPLETA L	COMPLETE GEAR HOUSING L	PIEDE COMPLETO L	EMBASE COMPLETE L
	PAF20-04000000S	6AH-45300-00-8D	COLA COMPLETA S	COMPLETE GEAR HOUSING S	PIEDE COMPLETO S	EMBASE COMPLETE S
1	REC90430-08020	90430-08003	ARANDELA	WASHER	RONDELLA	RONDELLE
2	REC90340-08002	90340-08002	TAPÓN ACEITE	PLUG, OIL	TAPPO OLIO	BOUCHON REMPLISSAGE D'HUILE
3	PAF15-00000013	93604-12M07	PIN CENTRADOR	HOLLOW PIN	SPINOTTO DI CENTRAGGIO	PIN DE CENTRAGE
4	PAF20-04000001	69G-45315-A0	JUNTA	GASKET	GUANIZIONE	JOINT
5	PAF15-06020005	63V-45375-00	RETÉN DE GOMA	SEAL, RUBBER	TENUTA IN COMMA	JOINT CAOUTCHOUC
6	REC93315-314V8	93315-314V8	RODAMIENTO	BALL BEARING	CUSCINETTO	ROULEMENT À BILLE
7	PAF15-06000006	63V-45536-00	CAMISA EJE	SLEEVE, DRIVE	TUBO GUIDA	TUBE GUIDE
8	PAF20-04010001	69G-45331-01-CA	CUERPO DEL COJINETE	SHELL, BEARING	CORPO DE CUSCINETTO	LOGEMENT DE PALIER
9	REC626-45316-09	626-45316-09	CASQUILLO EJE	BUSHER, SHAFT	GOMMINO ASSE	DOUILLE
10	REC93101-20048	93101-20001	RETÉN DE ACEITE	OIL SEAL	PARAOILIO	JOINT D'HUILE
11	PAF20-04020000S	6AH-44150-00	VARILLA SELECTOR S	CAM ASSY, SHIFT ROD S	ASTICELLA CAMBIO S	LEVIER DE VITESSE S
	PAF20-04020000L	6AH-44150-10	VARILLA SELECTOR L	CAM ASSY, SHIFT ROD L	ASTICELLA CAMBIO L	LEVIER DE VITESSE L
12	REC93210-06ME6	93210-06ME6	TÓRICA	O-RING	O-RING	JOINT TORIQUE
13	PAGB/T5783-M8X25	97080-08025	TORNILLO	SCREW	VITE	VIS

	REF	OEM				
14	PAF20-04030000L PAF20-04030000S	6AH-45510-10 6AH-45510-00	EJE VERTICAL L EJE VERTICAL S	DRIVE SHAFT L DRIVE SHAFT S	ASSE VERTICALE L ASSE VERTICALE S	ARBRE DE COMMANDE L ARBRE DE COMMANDE S
15	REC664-44338-00	664-44338-00	CUÑA	KEY WOODRUFF	CHIAVETTA	CLAVETTE
16	REC68T-44323-00	68T-44323-00	JUNTA TAPA BOMBA AGUA	GASKET, WATER PUMP COVER	GUARNIZIONE COPERCHIO	JOINT COUVERCLE
17	REC93210-49046	93210-49046	TÓRICA	O-RING	O-RING	JOINT TORIQUE
18	REC63V-44352-01	63V-44352-01	TURBINA BOMBA AGUA	IMPELLER, WATER PUMP	GIRANTE POMPA	TURBINE DE POMPE À EAU
19	REC63V-44322-00	63V-44322-00	TAPA, BOMBA AGUA	COVER, INNER WATER PUMP	COPERCHIO, POMPE ACQUA	COUVERCLE DE POMPE À EAU
20	PAF15-00000013	93604-12M07	PASADOR BOMBA AGUA	PIN, WATER PUMP	SPINOTTO POMPA ACQUA	LEVIER POMPE D'EAU
21	PAF20-04040001	6AH-44311-00	CUERPO BOMBA AGUA	HOUSING, WATER PUMP	CORPO POMPA	CORPS DE POMPE À EAU
22	PAF25-04050004	6L2-44367-00	TUBO GOMA BOMBA AGUA	RUBBER TUBE, WATER PUMP	TUBO IN GOMMA, POMPA	DURITE DE COUTCHOU
23	PAF15-06000014	63V-44328-01	PLACA	OUT PLATE	PIASTRA	PLAQUE
24	REC97095-08045	97095-08045	PERNO	STUD	BULLONE	BOULON
25	PAF20-02000005	6AH-44368-00	TUBO DE AGUA	WATER TUBE	TUBO DELL'ACQUA	DURITE D'EAU
26	PAF20-02000101L PAF20-02000101S	6AH-44361-11 6AH-44361-01	TUBO DE AGUA L TUBO DE AGUA S	WATER TUBE L WATER TUBE S	TUBO DELL'ACQUA L TUBO DELL'ACQUA S	DURITE D'EAU L DURITE D'EAU S
27	PAF20-02000007	6AH-44365-00	GOMA DEL TUBO DE AGUA	I-SHAPED RUBBER BAND	GOMMA TUBO ACQUA	PLOT CAOUTCHOU DE TUBE D'EAU
28	PAHT-2.5X50	90465-11M10	BRIDA 2,5X50	CLAMP	FASCETTA	COLLIER RILSAN 2,5X50
29	PAF15-06000010-1	664-45567-01	GRUESO 0.10 mm	SHIM 0.10 mm	SPESSORE 0.10 mm	CALE 0.10 mm
	PAF15-06000010-2	664-45567-10	GRUESO 0.12 mm	SHIM 0.12 mm	SPESSORE 0.12 mm	CALE 0.12 mm
	PAF15-06000010-3	664-45567-20	GRUESO 0.15 mm	SHIM 0.15 mm	SPESSORE 0.15 mm	CALE 0.15 mm
	PAF15-06000010-4	664-45567-30	GRUESO 0.18 mm	SHIM 0.18 mm	SPESSORE 0.18 mm	CALE 0.18 mm
	PAF15-06000010-5	664-45567-40	GRUESO 0.30 mm	SHIM 0.30 mm	SPESSORE 0.30 mm	CALE 0.30 mm
	PAF15-06000010-6	664-45567-50	GRUESO 0.40 mm	SHIM 0.40 mm	SPESSORE 0.40 mm	CALE 0.40 mm
	PAF15-06000010-7	664-45567-60	GRUESO 0.50 mm	SHIM 0.50 mm	SPESSORE 0.50 mm	CALE 0.50 mm
30	REC93332-00005	93332-00005	RODAMIENTO	BALL BEARING	CUSCINETTO	ROULEMENT À BILLE
31	REC6E7-45560-01	6E7-45560-01	PIÑÓN MARCHA AVANTE	POSITIVE GEAR ASSY	PIGNONE MARCIA AVANTI	PIGNON DE MARCHE AVANT
32	REC650-45635-00	650-45635-00	ÉMBOLO	PLUNGER	BULLONE	BOUCHON
33	REC682-45631-00	682-45631-00	SELECTOR	CLUTCH BLOCK	SELETTORE	SELECTEUR
34	REC90250-05010	90250-05010	PASADOR	PIN	SPINOTTO	LEVIER
35	REC648-45633-00	648-45633-11	MUELLE	SPRING	MOLLA	RESSORT
36	PAF15-06070002	90501-150A0	MUELLE	SPRING	MOLLA	RESSORT
37	REC683-45611-00	683-45611-00	EJE HÉLICE	PROPELLER SHAFT	ASSE ELICA	ARBRE D'HELICE
38	REC90201-17682	90201-17682	ARANDELA	WASHER	RONDELLA	RONDELLE
39	REC6E7-45570-00	6E7-45570-00	PIÑÓN MARCHA ATRÁS	REVERSE GEAR	PIGNONE MARCIA INDIETRO	PIGNON MARCHE ARRIÈRE
40	PAF15-06080006-1	626-45577-00	GRUESO 0.10 mm	SHIM 0.10 mm	SPESSORE 0.10 mm	CALE 0.10 mm
	PAF15-06080006-2	626-45577-10	GRUESO 0.20 mm	SHIM 0.20 mm	SPESSORE 0.20 mm	CALE 0.20 mm
	PAF15-06080006-3	626-45577-20	GRUESO 0.30 mm	SHIM 0.30 mm	SPESSORE 0.30 mm	CALE 0.30 mm
	PAF15-06080006-4	626-45577-30	GRUESO 0.40 mm	SHIM 0.40 mm	SPESSORE 0.40 mm	CALE 0.40 mm
	PAF15-06080006-5	626-45577-40	GRUESO 0.50 mm	SHIM 0.50 mm	SPESSORE 0.50 mm	CALE 0.50 mm
41	PAF15-06080000	683-45361-02-8D	FUNDA INFERIOR COMPLETA	COVER ASSY, LOWER CASING	COVER INFERIORE COMPLETA	DIABOLO COMPLET
42	REC93306-00501	93306-00501	COJINETE	BEARING	CUSCINETTO	ROULEMENT
43	REC93210-57M09	93210-57M09	TÓRICA	O-RING	O-RING	JOINT TORIQUE
44	PAF15-06080003	93210-56M80	TÓRICA	O-RING	O-RING	JOINT TORIQUE
45	REC683-45361-01-4D	683-45361-02-8D	DIÁBOLO	CAP, LOWER CASING	COPERCHIO CARTER INFERIORE	DIABOLO
46	PAGB/T5783-M6X20	97575-06520	TORNILLO	SCREW	VITE	VIS
47	REC93315-317U2	93315-317U2	COJINETE	BEARING	CUSCINETTO	PALIER
48	REC93101-17054	93101-17054	RETÉN DE ACEITE	OIL SEAL	PARAOLIO	JOINT SPI
49	REC6E7-45987-00	6E7-45987-01	ESPACIADOR	SPACER	DISTANZIALE	ENTRETOISE
50	PAGB/T96-10	90201-10M01	ARANDELA	WASHER	RONDELLA	RONDELLE
51	REC90171-10M01	90171-10M01	TUERCA	LOCK NUT	DADO	ÉCROU
52	REC91490-30025	94190-30020	PASADOR ALETAS	PIN, COTTER	PIN	GOUPILLE
53	PAGB/T6182-M5	90185-05002	TUERCA	LOCK NUT	DADO	ÉCROU
54	PAF15-06000002	63V-45215-00	CUBIERTA, ENTRADA AGUA 2	WATER INLET A	COPERCHIO ENTRATA ACQUA A	GRILLE D'ENTREE D'EAU A
55	PAF15-06000003	6G1-45214-00	CUBIERTA, ENTRADA AGUA 1	WATER INLET B	COPERCHIO ENTRATA ACQUA B	GRILLE D'ENTREE D'EAU B
56	PAGB/T820-M5X20	90152-05011	TORNILLO	SCREW	VITE	VIS
57	PAF15-06000020-1	90201-15017	ARANDELA	WASHER	RONDELLA	RONDELLE
58	PAF15-06000008	6E8-45587-10	GRUESO 1.13 mm	SHIM 1.13 mm	SPESSORE 1.13 mm	CALE 1.13 mm
	PAF15-06000009	6E8-45587-30	GRUESO 1.20 mm	SHIM 1.20 mm	SPESSORE 1.20 mm	CALE 1.20 mm
59	REC63V-45551-00	63V-45551-00	PIÑÓN ATAQUE	INITIATIVE GEAR	MARCIA INIZIATIVA	PIGNON D'ATTAQUE
60	REC90179-08M06	90179-08M06	TUERCA	LOCK NUT	DADO	ÉCROU
61	PAGB/T5783-M8X30	97575-08530	PERNO	STUD	BULLONE	BOULON
62	TEN01154AL	6AH-45251-00	ÁNODO	ANODE	ANODO	ANODE
63	PAGB/T861.1-6	92990-06300	ARANDELA	WASHER	RONDELLA	RONDELLE
64	PAGB/T5783-M6X30	95895-06035	TORNILLO	SCREW	VITE	VIS

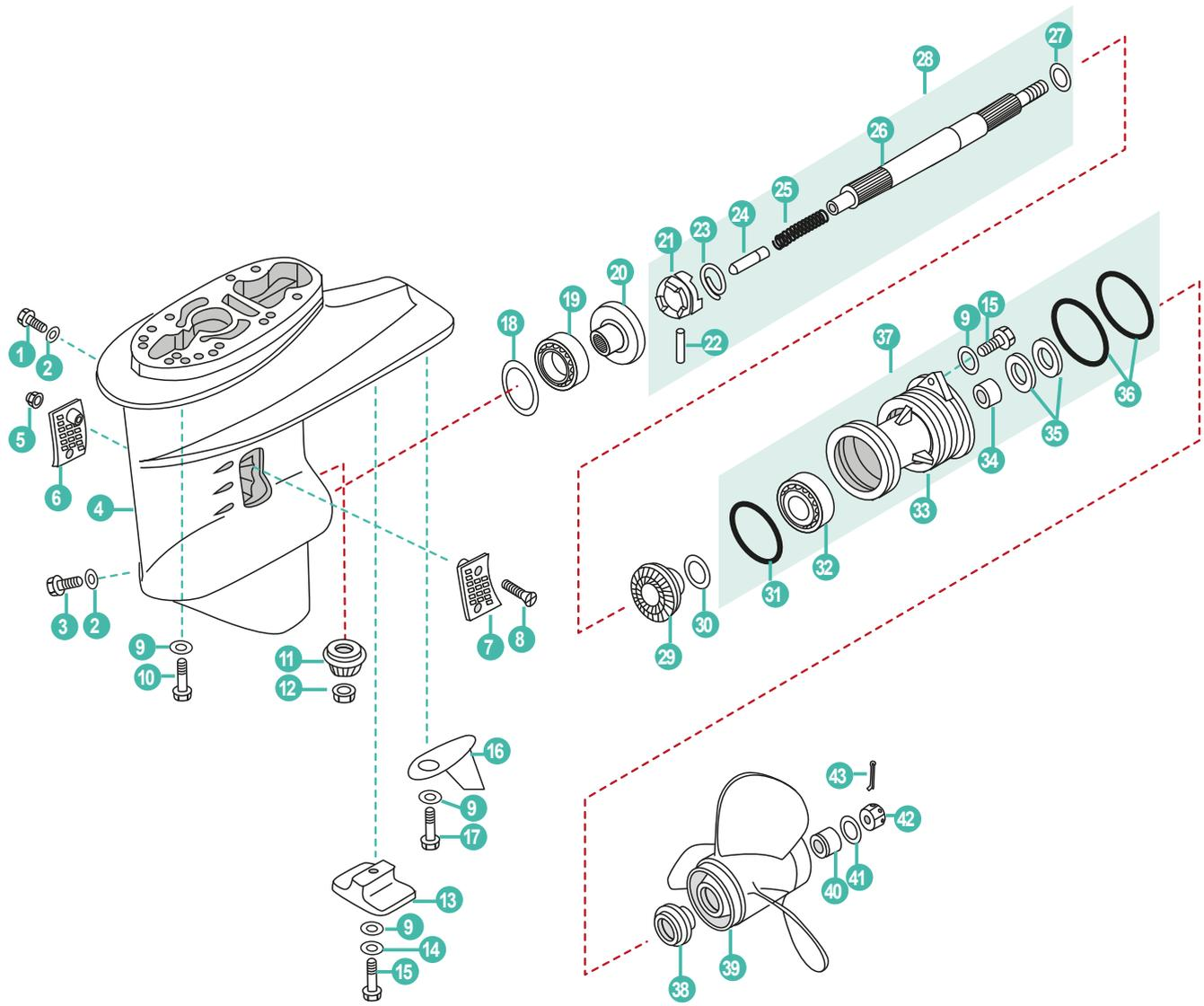



	REF	OEM				
	PAF25-04090000L	65W-45300-10-4D	COLA COMPLETA L	COMPLETE GEAR HOUSING L	PIEDE COMPLETO L	EMBASE COMPLETE L
	PAF25-04090000S	65W-45300-00-4D	COLA COMPLETA S	COMPLETE GEAR HOUSING S	PIEDE COMPLETO S	EMBASE COMPLETE S
1	REC90340-08002	90340-08M04	TAPÓN ACEITE	PLUG, OIL	TAPPO OLIO	BOUCHON REMPLISSAGE D'HUILE
2	REC90430-08020	93210-06ME6	JUNTA	GASKET	GUANIZIONE	JOINT
3	REC688-45341-00	688-45341-00	TAPÓN DE DESAGÜE	PLUG, DRAIN	TAPPO DRENAGGIO	BOUCHON DE VIDANGE
4	PAF25-04000001	61N-45311-02-4D	CARTER	LOWER CASING	CARTER	CARTER D'EMBASE
5	PAGB/T889.1-2000	90185-05002	TUERCA	NUT, LOCKING	DADO	ÉCROU
6	PAF25-04000023	6L2-45215-00	CUBIERTA ENTRADA AGUA B	WATER INLET B	COPERCHIO ACQUA B	GRILLE D'ENTREE D'EAU B
7	PAF25-04000022	6L2-45214-00	CUBIERTA ENTRADA AGUA A	WATER INLET A	COPERCHIO ACQUA A	GRILLE D'ENTREE D'EAU A
8	PAGB/T820-M5X30	90151-05M05	TORNILLO	SCREW, PAN HEAD	VITE	VIS
9	PAGB/T97.1-8	92995-10600	ARANDELA	WASHER	RONDELLA	RONDELLE
10	PAF25-00000011	90105-10M12	TORNILLO	BOLT	VITE	VIS
11	PAF25-04000005	61N-45551-00	PIÑÓN ATAQUE	INITIATIVE GEAR	MARCIA INIZIATIVA	PIGNON D'ATTAQUE
12	REC90179-10M14	90179-10M14	TUERCA	NUT, PINION	DADO	ÉCROU
13	PAF15-06000004	61N-45251-00	ÁNODO	ANODE, LOWER	ANODO	ANODE
14	PAGB/T861.1-87	92990-06300	ARANDELA	WASHER, LOCKING	RONDELLA	RONDELLE
15	PAGB/T5782-M6X125	95895-06035	TORNILLO	BOLT	VITE	VIS
16	PAF25-04000021	61N-45214-00	PLACA TIMÓN	TAB, COURSE	PIASTRA TIMONE	DERIVE
17	PAGB/T5783-M5X12	90119-06M48	TORNILLO	BOLT	VITE	VIS
18	PAF25-04000004-3	6L2-45567-12	GRUESO 1.2 mm	SHIM 1.2 mm	SPESSORE 1.2 mm	CALE 1.2 mm
	PAF25-04000004-5	6L2-45567-14	GRUESO 1.4mm	SHIM 1.4 mm	SPESSORE 1.4 mm	CALE 1.4 mm
19	REC93332-00005	93332-00005	RODAMIENTO	BALL BEARING	CUSCINETTO	ROULEMENT À BILLE
20	REC61N-45560-10	61N-45560-00	PIÑÓN MARCHA AVANTE	POSITIVE GEAR ASSY	PIGNONE MARCIA AVANTI	PIGNON DE MARCHÉ AVANT
21	PAF25-04060003	664-45631-02	SELECTOR	CLUTCH BLOCK	SELETTORE	CRABOT
22	REC90250-05010	90250-05010	PASADOR	PIN	SPINOTTO	LEVIER
23	REC648-45633-00	648-45633-00	MUELLE	SPRING	MOLLA	RESSORT
24	REC648-45635-00	648-45635-00	ÉMBOLO	PLUNGER	BULLONE	BOUCHON
25	PAF25-04060002	90501-10065	MUELLE	SPRING	MOLLA	RESSORT
26	REC6L2-45611-00	612-45611-00	EJE HÉLICE	PROPELLER SHAFT	ASSE ELICA	ARBRE D'HELICE
27	PAF25-04060007	90201-20417	GRUESO	SHIM	SPESSORE	CALE
28	PAF25-04060000	648-45633-11	EJE HÉLICE COMPELTO	PROPELLER, SHAFT ASSY	ASSE ELICHE COMPLETO	ARBRE D'HELICE COMPLÈTE
29	PAF25-04070004	61N-45571-00	PIÑÓN MARCHA INVERSA	GEAR, REVERSE	MARCIA INDIETRO	PIGNON MARCHÉ ARRIÈRE
30	PAF25-04070005-1	6L2-45577-00-10	GRUESO 1.0 mm	SHIM 1.0 mm	SPESSORE 1.0 mm	CALE 1.0 mm
	PAF25-04070005-3	6L2-45577-00-12	GRUESO 1.2 mm	SHIM 1.2 mm	SPESSORE 1.2 mm	CALE 1.2 mm
31	REC93210-64ME7	93210-64ME7	TÓRICA	O-RING	O-RING	JOINT TORIQUE
32	PAGB/T276-6006/P6	93306-00612	RODAMIENTO	BALL BEARING	CUSCINETTO	ROULEMENT À BILLE
33	PAF25-04070001	61N-45361-01-4D	DIÁBOLO	CAP, LOWER CASING	COPERCHIO CARTER INFERIORE	DIABOLO
34	REC93315-22004	93315-22004	RODAMIENTO	BALL BEARING	CUSCINETTO	ROULEMENT À BILLE
35	REC93101-20M07	93101-20M07	RETÉN DE ACEITE	OIL SEAL	PARAOLIO	JOINT SPI
36	REC93210-65M50	93210-65M50	TÓRICA	O-RING	O-RING	JOINT TORIQUE
37	PAF25-04070000	61N-45361-01-8D	TAPA CÁRTER COMPLETA	COVER ASSY, LOWER CASING	COPERCHIO CARTER COMPLETA	DIABOLO COMPLET
38	REC6L2-45987-00	6L2-45987-01	ESPACIADOR	SPACER, PROPELLER	SPESSORE	ENTRETOISE
39	PAF25-04080000	664-45947-01-EL	HÉLICE	PROPELLER ASSY	ELICHE	HELICE
40	REC689-45997-00	689-45997-00	ESPACIADOR	SPACER	SPESSORE	ENTRETOISE
41	PAGB/T97.1-8	92990-14200	ARANDELA	WASHER	RONDELLA	RONDELLE
42	REC90171-14013-00	90171-14013	TUERCA	NUT	DADO	ÉCROU
43	PAGB/T91-1.6X12	91490-30022	PIN	PIN, COTTER	SPINOTTO	GOUPILLE

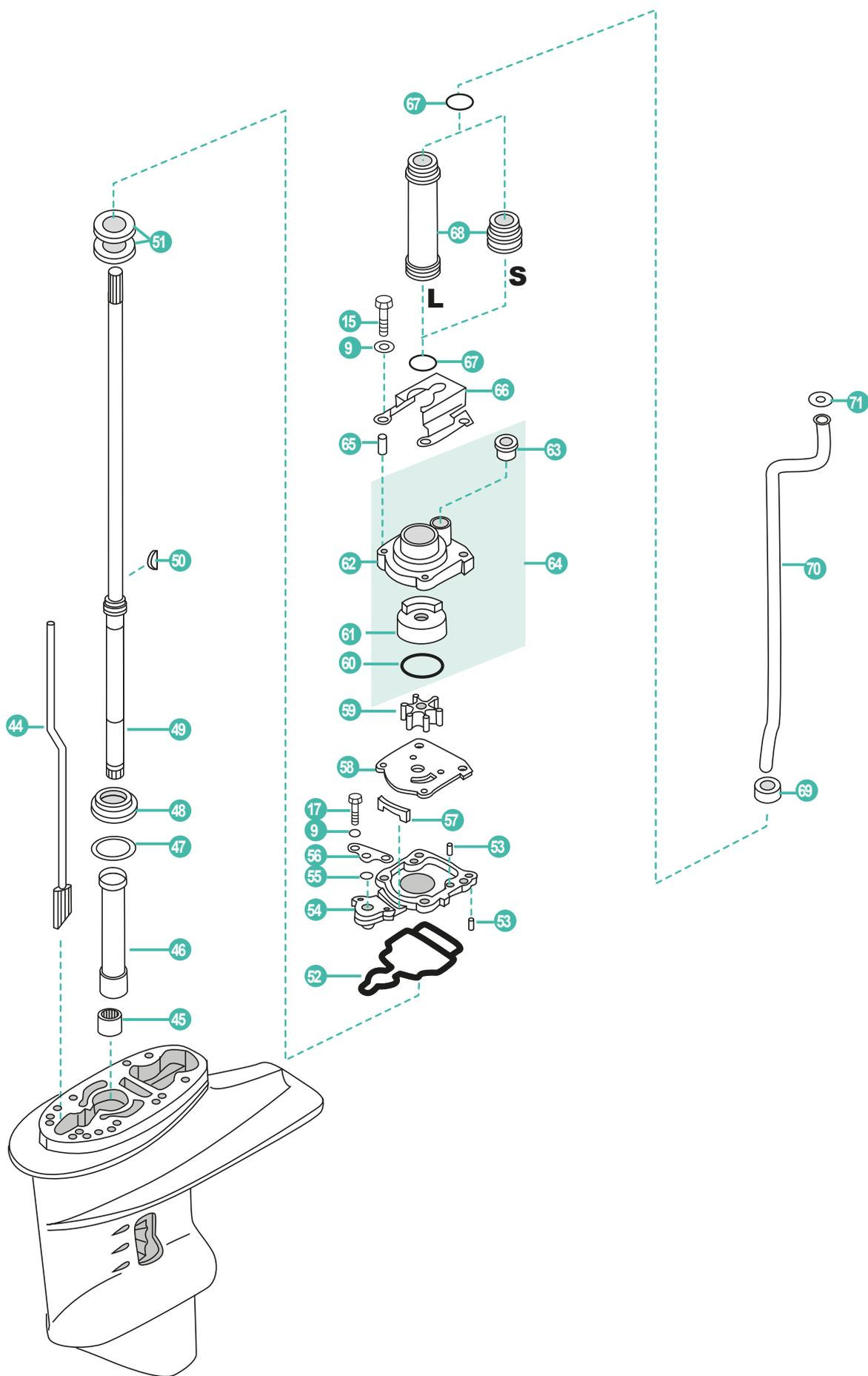

	REF	OEM				
44	PAF25-04030000L	65W-44150-10	VARILLA SELECTOR L	CAM ASSY, SHIFT ROD L	ASTICELLA CAMBIO L	LEVIER DE VITESSE L
	PAF25-04030000S	65W-44150-00	VARILLA SELECTOR S	CAM ASSY, SHIFT ROD S	ASTICELLA CAMBIO S	LEVIER DE VITESSE S
45	PAGB/T290F-2020	93315-220V7	RODAMIENTO	BALL BEARING	CUSCINETTO	ROULEMENT À BILLE
46	PAF25-04000002	61N-45536-00	CASQUILLO	BUSHING, NYLON	GHIERA	BAGUE NYLON
47	PAF25-04000003-2	61N-45587-00-10	GRUESO 1.0 mm	SHIM 1.0 mm	SPESSORE 1.0 mm	CALE 1.0 mm
	PAF25-04000003-3	61N-45587-00-11	GRUESO 1.1 mm	SHIM 1.1 mm	SPESSORE 1.1 mm	CALE 1.1 mm
	PAF25-04000003-4	61N-45587-00-12	GRUESO 1.2 mm	SHIM 1.2 mm	SPESSORE 1.2 mm	CALE 1.2 mm
	PAF25-04000003-5	61N-45587-00-13	GRUESO 1.3 mm	SHIM 1.3 mm	SPESSORE 1.3 mm	CALE 1.3 mm
	PAF25-04000003-6	61N-45587-00-14	GRUESO 1.4mm	SHIM 1.4 mm	SPESSORE 1.4 mm	CALE 1.4 mm
	PAF25-04000003-7	61N-45587-00-15	GRUESO 1.5mm	SHIM 1.5 mm	SPESSORE 1.5 mm	CALE 1.5 mm
	48	PAHI-CAP32004JRK0YO	93332-000W5	CUERPO RODAMIENTO	HOUSING, BEARING	CORPO CUSCINETTO
49	PAF25-04010000L	61N-45510-10	EJE VERTICAL L	DRIVE SHAFT L	ASSE VERTICALE L	ARBRE DE COMMANDE L
	PAF25-04010000S	61N-45510-00	EJE VERTICAL S	DRIVE SHAFT S	ASSE VERTICALE S	ARBRE DE COMMANDE S
50	PAF25-04000015	90280-03024	CHAVETA	KEY WOODRUFF	CHIAVETTA	CLAVETTE
51	REC93101-22M00	93101-22067	RETÉN DE ACEITE	OIL SEAL	PARAOILIO	JOINT D'HUILE
52	PAF25-04000009	61N-45315-00	RETÉN	SEAL	TENUTA	JOINT
53	PAF25-04000007	93604-10M03	PIN	PIN, COTTER	SPINOTTO	PLOT DE CENTRAGE F4X12
54	PAF25-04000008	65W-45331-00-5B	BASE EJE VERTICAL	BASE, DRIVE SHAFT	BASE, ASSE VERTICALE	BASE POUR ARBRE D'ENTRAÎNEMENT
55	REC93210-06ME6	93210-06ME6	TÓRICA	O-RING	O-RING	JOINT TORIQUE
56	PAF25-04000012	65W-44176-00	PLACA	OUT PLATE	PIASTRA	PLAQUE
57	PAF25-04000013	61N-45127-00	RETÉN AGUA	WATER SEAL	PARAOILIO ACQUA	RONDELLE JOINT
58	REC61N-44323-00	61N-44323-00	JUNTA TAPA BOMBA AGUA	GASKET, WATER PUMP COVER	GUARNIZIONE COPERCHIO	JOINT COUVERCLE
59	REC6H4-44352-02	6H4-44352-02	TURBINA BOMBA AGUA	IMPELLER, WATER PUMP	GIRANTE POMPA	TURBINE DE POMPE À EAU
60	PAF25-04050003	93210-45161	TÓRICA	O-RING	O-RING	JOINT TORIQUE
61	REC61N-44322-00	61N-44322-01	ACOPLE INOX	INSERT CARTRIDGE	ACCOPPIAMENTO INOX	INSERT DE POMPE À EAU
62	PAF25-04050001	61N-44311-01	CUERPO BOMBA	SHELL, WATER PUMP	CORPO POMPA	CORPS DE POMPE À EAU
63	PAF25-04050004	6L2-44367-00	RETÉN TUBO AGUA	DAMPER, WATER PIPE	AMMORTIZZATORE, TUBO DELL'ACQUA	MANCHON TUYAU D'EAU
64	PAF25-04050000	61N-44311-01	KIT CUERPO BOMBA	SHELL ASSY, WATER PUMP	KIT CORPO POMPA	KIT COPRS DE POMPE À EAU
65	REC93606-12019	93606-11M24	PIN	PIN, DOWEL	SPINOTTO	PLOT DE CENTRAGE
66	PAF25-04000016	65W-44328-00	PLATO FIJO BOMBA AGUA	FIXED PLATE, WATER PUMP	PIASTRA POMPA	PLAQUE FIXATION CORPS DE POMPE À EAU
67	PAGB/T3452.1-25.8X2	93210-26130	TÓRICA	O-RING	O-RING	JOINT TORIQUE
68	PAF25-04000017	61N-44362-10	TUBO DE AGUA L	WATER TUBE L	TUBO DELL'ACQUA L	DURITE D'EAU L
	PAF25-04000017S	61N-44362-00	TUBO DE AGUA S	WATER TUBE S	TUBO DELL'ACQUA S	DURITE D'EAU S
69	PAF25-02000005	90430-12072	JUNTA AGUA	GASKET, WATER PIPE	GUARNIZIONE	JOINT
70	PAF25-02000004L	65W-44361-10	TUBO DE AGUA L	WATER TUBE L	TUBO DELL'ACQUA L	DURITE D'EAU L
	PAF25-02000004S	65W-44361-00	TUBO DE AGUA S	WATER TUBE S	TUBO DELL'ACQUA S	DURITE D'EAU S
71	PAF25-02000019	90202-12060	ARANDELA	WASHER, NYLON	RONDELLA	RONDELLE



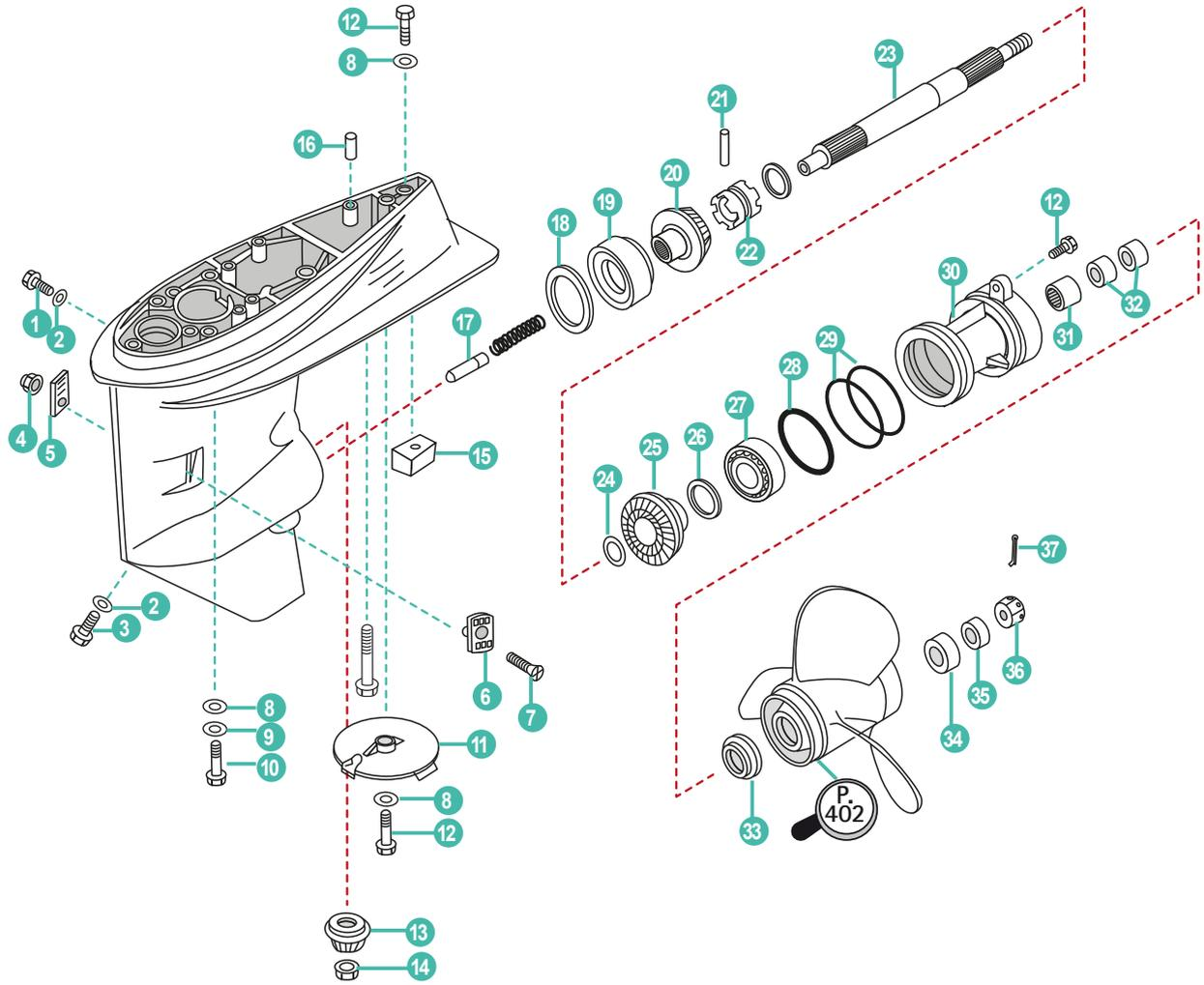

REF	OEM
REC67C-W0001-20	67C-W0001-20

REF	OEM
REC66T-W0078-00	66T-W0078-00

REF
REC80W90U3
REC80W90U6
RECGREU1
RECGREU12

	REF	OEM				
1	REC90340-08002	90340-08002	TAPÓN ACEITE	PLUG, OIL	TAPPO OLIO	BOUCHON DE NIVEAU D'HUILE
2	REC90430-08020	90430-08020	JUNTA	GASKET	GUARNIZIONE	JOINT
3	REC688-45341-00	688-45341-10	TAPÓN ACEITE	PLUG, OIL	TAPPO OLIO	BOUCHON REMPLISSAGE D'HUILE
4	PAGB/T889.1-M5	95380-05600	TUERCA	LOCK NUT	DADO	ÉCROU
5	PAT40-04000023	63D-45215-00	CUBIERTA ENTRADA AGUA B	WATER INLET B	COPERCHIO ACQUA B	GRILLE D'ENTREE D'EAU B
6	PAT40-04000022	63D-45214-00	CUBIERTA ENTRADA AGUA A	WATER INLET A	COPERCHIO ACQUA A	GRILLE D'ENTREE D'EAU A
7	PAGB/T820-M5X30	90142-05M06	TORNILLO	SCREW	VITE	VIS
8	PAGB/T97.1-8	92995-10600	ARANDELA	WASHER	RONDELLA	RONDELLE
9	PAGB/T97.1-10	92995-10100	ARANDELA	WASHER	RONDELLA	RONDELLE
10	REC97075-10040	97075-10040	PERNO	STUD	BULLONE	BOULON
11	CM67C-45371-00A	67C-45371-00	ÁNODO	ANODE	ANODO	ANODE
12	PAGB/T5783-M8X25	97095-08025	PERNO	STUD	BULLONE	BOULON
13	REC66T-45551-00	66T-45551-00	PIÑÓN ATAQUE	INITIATIVE GEAR	MARCIA INIZIATIVA	PIGNON D'ATTAQUE
14	REC90170-12138	90170-12138	TUERCA	LOCK NUT	DADO	ÉCROU
15	CM67C-45251-00A	67C-45251-00	ÁNODO	ANODE	ANODO	ANODE
16	REC93606-12019	93606-12019	PASADOR	PIN	SPINOTTO	LEVIER
17	REC66T-45635-00	66T-45635-00	ÉMBOLO	PLUNGER	BULLONE	BOUCHON
	PAT40-04000004-1	663-45567-01	GRUESO 0.10 mm	SHIM 0.10 mm	SPESSORE 0.10 mm	CALE 0.10 mm
18	PAT40-04000004-2	663-45567-10	GRUESO 0.12 mm	SHIM 0.12 mm	SPESSORE 0.12 mm	CALE 0.12 mm
	PAT40-04000004-3	663-45567-20	GRUESO 0.15 mm	SHIM 0.15 mm	SPESSORE 0.15 mm	CALE 0.15 mm
	PAT40-04000004-5	663-45567-40	GRUESO 0.30 mm	SHIM 0.30 mm	SPESSORE 0.30 mm	CALE 0.30 mm
19	REC93332-00003	93332-00003	COJINETE	BEARING	CUSCINETTO	PALIER
20	REC66T-45560-00	66T-45560-01	PIÑÓN MARCHA AVANTE	POSITIVE GEAR ASSY	PIGNONE MARCIA AVANTI	PIGNON DE MARCHE AVANT
21	REC90250-06023	90250-06023	PASADOR	PIN	SPINOTTO	PIN
22	REC66T-45631-00	66T-45631-00	SELECTOR	CLUTCH BLOCK	SELETTORE	CRABOT
23	REC66T-45611-00	66T-45611-00	EJE HÉLICE	PROPELLER SHAFT	ASSE ELICA	ARBRE D'HELICE
24	REC90201-22429	90201-22429	ARANDELA	WASHER	RONDELLA	RONDELLE
25	REC66T-45571-00	66T-45571-00	PIÑÓN MARCHA ATRÁS	REVERSE GEAR	PIGNONE MARCIA INDIETRO	PIGNON MARCHE ARRIÈRE
	PAT40-04060005-2	63D-45577-10	GRUESO 0.12 mm	SHIM 0.12 mm	SPESSORE 0.12 mm	CALE 0.12 mm
	PAT40-04060005-3	63D-45577-20	GRUESO 0.15 mm	SHIM 0.15 mm	SPESSORE 0.15 mm	CALE 0.15 mm
26	PAT40-04060005-4	63D-45577-30	GRUESO 0.18 mm	SHIM 0.18 mm	SPESSORE 0.18 mm	CALE 0.18 mm
	PAT40-04060005-5	63D-45577-40	GRUESO 0.30 mm	SHIM 0.30 mm	SPESSORE 0.30 mm	CALE 0.30 mm
	PAT40-04060005-6	63D-45577-50	GRUESO 0.40 mm	SHIM 0.40 mm	SPESSORE 0.40 mm	CALE 0.40 mm
	PAT40-04060005-7	63D-45577-60	GRUESO 0.50 mm	SHIM 0.50 mm	SPESSORE 0.50 mm	CALE 0.50 mm
27	REC93306-001U1	93306-001U1	COJINETE	BEARING	CUSCINETTO	PALIER
28	REC93210-69MG6	93210-69MG6	TÓRICA	O-RING	O-RING	JOINT TORIQUE
29	REC93210-74MG5	93210-74MG5	TÓRICA	O-RING	O-RING	JOINT TORIQUE
30	REC63D-45361-02-4D	63D-45361-02-4D	DIÁBOLO	CAP, LOWER CASING	COPERCHIO CARTER INFERIORE	DIABOLO
31	REC93317-22204	93317-22204	COJINETE	BEARING	CUSCINETTO	PALIER
32	REC93101-22M00	93101-22M00	RETÉN DE ACEITE	OIL SEAL	PARAOLIO	JOINT SPI
33	REC663-45987-00	663-45987-02	ESPACIADOR	SPACER	DISTANZIALE	ENTRETOISE
34	REC66T-45997-00	66T-45997-00	ESPACIADOR	SPACER	DISTANZIALE	ENTRETOISE
35	REC90389-22M01	90389-22M01	CASQUILLO HÉLICE	WASHER	GHIERA ELICA	RONDELLE D'HELICE
36	REC90171-16011	90171-16011	TUERCA	LOCK NUT	DADO	ÉCROU
37	REC91490-30025	91490-30025	PASADOR	PIN	SPINOTTO	LEVIER

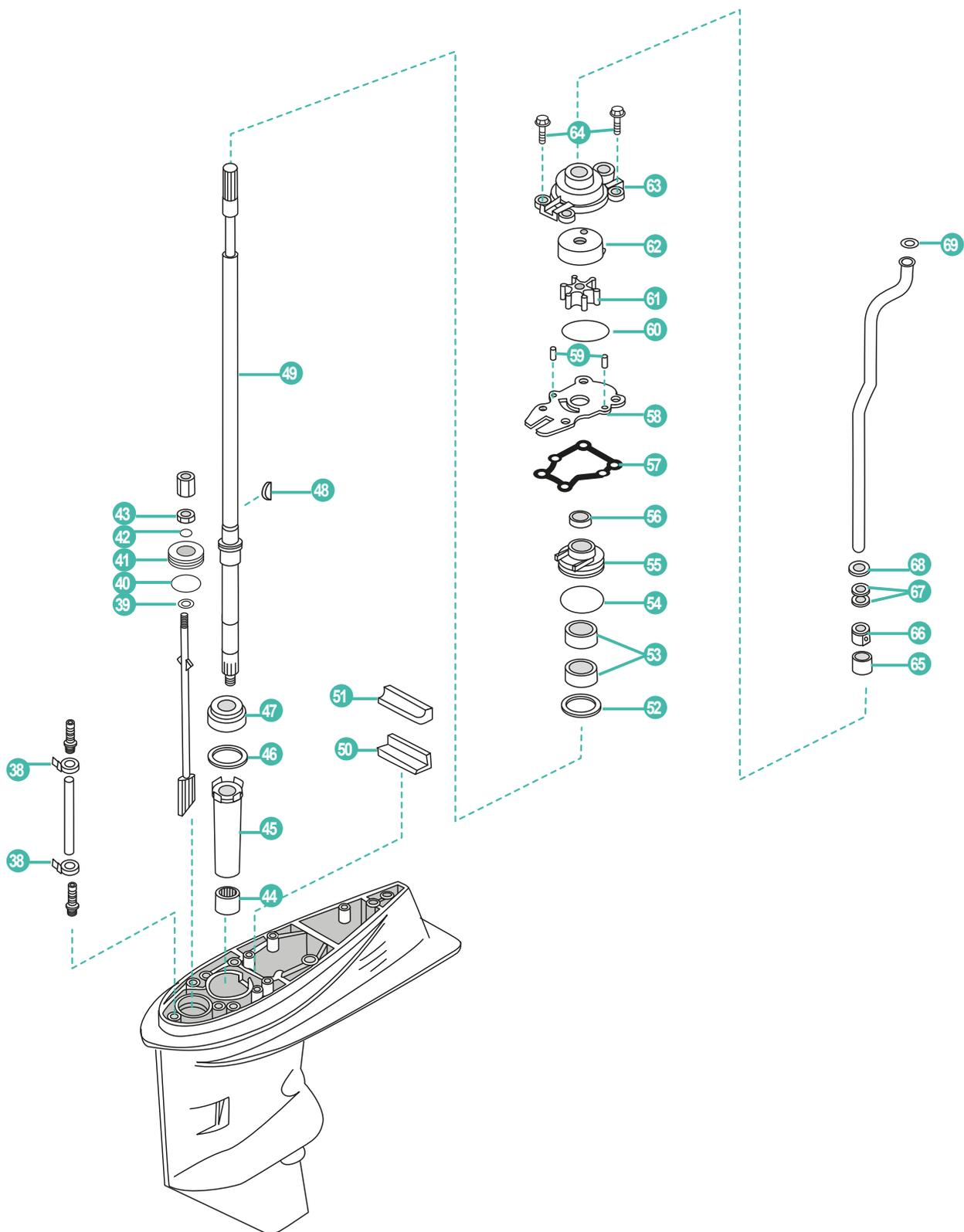

	REF	OEM				
38	PAHT-2.5X60	90465-11M10	BRIDA	CLAMP	FLANGIA	COLLIER
39	PAGB/T97.1-6	92990-06600	ARANDELA	WASHER	RONDELLA	RONDELLE
40	REC93210-33MG4	93210-33MG4	TÓRICA	O-RING	O-RING	JOINT TORIQUE
41	PAT40-04000007	66T-45321-00	PLACA	COVER PLATE, CAMSHAFT	PLACCA	COUVERCLE
42	REC93210-06ME6	93210-06ME6	TÓRICA	O-RING	O-RING	JOINT TORIQUE
43	REC95380-06700	95380-06700	TUERCA	LOCK NUT	DADO	ÉCROU
44	REC93315-32224	93315-32224	COJINETE	BEARING	CUSCINETTO	PALIER
45	PAT40-04000002	6H4-45536-00	CAMISA EJE	SLEEVE, DRIVE	TUBO GUIDA	BAGUE NYLON
	PAT40-04000003-1	663-45587-01	GRUESO 0.10 mm	SHIM 0.10 mm	SPESSORE 0.10 mm	CALE 0.10 mm
	PAT40-04000003-2	663-45587-10	GRUESO 0.12 mm	SHIM 0.12 mm	SPESSORE 0.12 mm	CALE 0.12 mm
	PAT40-04000003-3	663-45587-20	GRUESO 0.15 mm	SHIM 0.15 mm	SPESSORE 0.15 mm	CALE 0.15 mm
46	PAT40-04000003-4	663-45587-30	GRUESO 0.18 mm	SHIM 0.18 mm	SPESSORE 0.18 mm	CALE 0.18 mm
	PAT40-04000003-5	663-45587-40	GRUESO 0.30 mm	SHIM 0.30 mm	SPESSORE 0.30 mm	CALE 0.30 mm
	PAT40-04000003-6	663-45587-50	GRUESO 0.40 mm	SHIM 0.40 mm	SPESSORE 0.40 mm	CALE 0.40 mm
	PAT40-04000003-7	663-45587-60	GRUESO 0.50 mm	SHIM 0.50 mm	SPESSORE 0.50 mm	CALE 0.50 mm
47	REC93332-00001	93332-00001	COJINETE	BEARING	CUSCINETTO	ROULEMENT
48	REC90280-03M03	90280-03M03	CHAVETA	KEY WOODRUFF	CHIAVETTA	CLAVETTE
49	REC67C-45501-10	67C-45501-10	EJE VERTICAL L	DRIVE SHAFT L	ASSE VERTICALE L	ARBRE DE COMMANDE L
	REC67C-45501-00	67C-45501-00	EJE VERTICAL S	DRIVE SHAFT S	ASSE VERTICALE S	ARBRE DE COMMANDE S
50	REC663-45376-00	663-45376-00-94	GUÍA SELLO DE GOMA	GUIDE RUB. SEAL	GUIDA PARAOLIO	GUIDE
51	PAT40-04000014	63D-45375-00	SELLO DE GOMA	WATER ENVELOP	PARAOLIO	PROTECTION TUYAU D'EAU
52	PAT40-04000008	90201-27M00	ARANDELA	WASHER	RONDELLA	RONDELLE
53	REC93101-22M60	93101-22M60	RETÉN DE ACEITE	OIL SEAL	PARAOLIO	JOINT SPI
54	REC93210-48MG8	93210-48MG8	TÓRICA	O-RING	O-RING	JOINT TORIQUE
55	REC63D-44341-00	63D-44341-00	CUERPO BOMBA DE AGUA	SHELL, WATER PUMP	CORPO POMPA	INSERT POMPE À EAU
56	PAT40-04000009	66T-45344-01	CUBIERTA SELLO DE ACEITE	COVER, OIL SEAL	COPERCHIO, PARAOLIO	JOINT SPI
57	REC63D-44316-00	63D-44316-00	JUNTA	GASKET	GUARNIZIONE	JOINT
58	REC66T-44323-00	66T-44323-00	PLACA EXTERIOR	OUTER PLATE	PIASTRA POMPA ACQUA	PLAQUE DE POMPE À EAU
59	PAF25-04000007	93604-08062	PASADOR	PIN	SPINOTTO	PIN
60	REC93210-59MG7	93210-59MG7	TÓRICA	O-RING	O-RING	JOINT TORIQUE
61	REC6H4-44352-02	6H4-44352-02	TURBINA	IMPELLER	GIRANTE	TURBINE
62	REC63D-44322-00	63D-44322-00	TAPA, BOMBA AGUA	COVER, INNER WATER PUMP	COPERCHIO, POMPE ACQUA	COUVERCLE, POMPE D'EAU
63	PAT40-04000201	66T-44311-00	CUERPO BOMBA AGUA	HOUSING, WATER PUMP	CORPO POMPA	LOGEMENT POMPE D'EAU
64	REC90119-08M15	90119-08M15	TORNILLO CON ARANDELA	SCREW WITH WASHER	VITE CON RONDELLA	VIS AVEC RONDELLE
65	REC663-44366-00	663-44366-00	GOMA DEL SELLO DE AGUA	DAMPER, WATER SEAL	GHIERA	JOINT DE TUBE D'EAU
66	REC63D-44312-00	63D-44312-00	CUBIERTA CAJA DE BOMBA DE AGUA	PUMP COVER	COPERCHIO POMPA ACQUA	PLAQUE POMPE À EAU
67	PAT40-02000002	663-44367-00	GOMA DEL SELLO DE AGUA	GUIDE BUSHING, WATER PIPE	PARAOLIO	MAUCHON CAOUTCHOUC DE PIPE D'EAU
68	REC90430-12072	90430-12072	JUNTA	GASKET	GUARNIZIONE	JOINT
69	PAF25-02000019	90202-12060	ARANDELA PLANA	WASHER	RONDELLA PIANA	RONDELLE

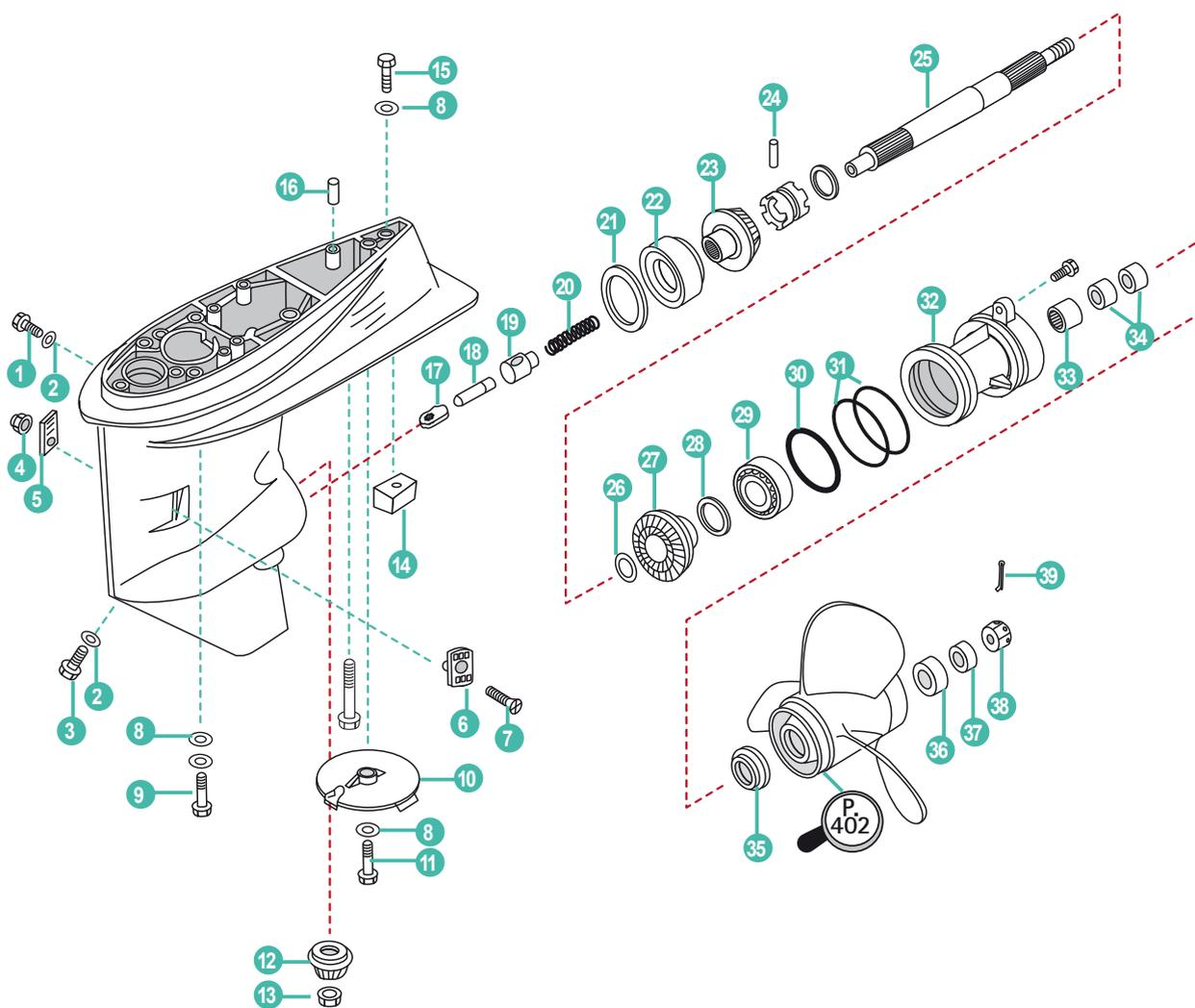

REF	OEM
REC6BG-W0078-00	6BG-W0078-00

REF
REC80W90U3
REC80W90U6
RECGREU1
RECGREU12



	REF	OEM				
1	REC90340-08002	90340-08002	TORNILLO DRENAJE	BOLT, DISCHARGING OIL	VITE DRENAGGIO	BOUCHON DE VIDANGE
2	REC90430-08020	90430-08003	JUNTA	GASKET	GUARNIZIONE	JOINT
3	REC688-45341-00	688-45341-10	TORNILLO DRENAJE	BOLT, DISCHARGING OIL	VITE DRENAGGIO	BOUCHON DE VIDANGE
4	PAGB/T889.1-M5	95380-05600	TUERCA	LOCK NUT	DADO	ÉCROU
5	PAT40-04000023	63D-45215-00	CUBIERTA ENTRADA AGUA B	WATER INLET B	COPERCHIO ACQUA B	GRILLE D'ENTREE D'EAU B
6	PAT40-04000022	63D-45214-00	CUBIERTA ENTRADA AGUA A	WATER INLET A	COPERCHIO ACQUA A	GRILLE D'ENTREE D'EAU A
7	PAGB/T820-M5X30	90152-05010	TORNILLO	SCREW	VITE	VIS
8	PAGB/T97.1-8	92995-10600	ARANDELA	WASHER	RONDELLA	RONDELLE
9	REC97075-10040	97075-10040	PERNO	STUD	BULLONE	BOULON
10	CM67C-45371-00A	67C-45371-00	ÁNODO	ANODE	ANODO	ANODE
11	PAGB/T5783-M8X25	97095-08025	PERNO	STUD	BULLONE	BOULON
12	REC66T-45551-00	66T-45551-00	PIÑÓN ATAQUE	INITIATIVE GEAR	MARCIA INIZIATIVA	PIGNON D'ATTAQUE
13	REC90170-12138	90170-12138	TUERCA	LOCK NUT	DADO	ÉCROU
14	CM67C-45251-00A	67C-45251-00	ÁNODO	ANODE	ANODO	ANODE
15	PAGB/T5783-M8X35	97095-08035	PERNO	STUD	BULLONE	BOULON
16	REC93606-12019	93606-12019	PASADOR	PIN	SPINOTTO	LEVIER
17	PAF60-04000003	62Y-44151-00	LEVA DE CAMBIO	SHIFTING CAM	LEVA CAMBIO	CAME DE CHANGEMENT
18	PAF60-04020005	63D-45635-00	ÉMBOLO	PLUNGER	BULLONE	BOUCHON
19	REC663-45634-00	663-45634-00	DESILIZADOR DEL CAMBIO	CLUTCH DOG	TRAINABILE CAMBIO	PIVOT
20	PAF60-04020002	90501-18001	MUELLE	SPRING	MOLLA	RESSORT
	PAT40-04000004-1	663-45567-01	GRUESO 0.10 mm	SHIM 0.10 mm	SPESSORE 0.10 mm	CALE 0.10 mm
21	PAT40-04000004-2	663-45567-10	GRUESO 0.12 mm	SHIM 0.12 mm	SPESSORE 0.12 mm	CALE 0.12 mm
	PAT40-04000004-3	663-45567-20	GRUESO 0.15 mm	SHIM 0.15 mm	SPESSORE 0.15 mm	CALE 0.15 mm
	PAT40-04000004-5	663-45567-40	GRUESO 0.30 mm	SHIM 0.30 mm	SPESSORE 0.30 mm	CALE 0.30 mm
22	REC93332-00003	93332-00003	COJINETE	BEARING	CUSCINETTO	ROULEMENT
23	REC66T-45560-00	66T-45560-01	PIÑÓN MARCHA AVANTE	POSITIVE GEAR ASSY	PIGNONE MARCIA AVANTI	PIGNON DE MARCHE AVANT
24	REC90250-06023	90250-06023	PASADOR	PIN	SPINOTTO	PIN
25	PAF60-04020001	63D-45611-00	EJE HÉLICE	PROPELLER SHAFT	ASSE ELICA	ARBRE D'HELICE
26	REC90201-22429	90201-22429	ARANDELA	WASHER	RONDELLA	RONDELLE
27	REC66T-45571-00	66T-45571-00	PIÑÓN MARCHA ATRÁS	REVERSE GEAR	PIGNONE MARCIA INDIETRO	PIGNON MARCHE ARRIÈRE
	PAT40-04060005-2	63D-45577-10	GRUESO 0.12 mm	SHIM 0.12 mm	SPESSORE 0.12 mm	CALE 0.12 mm
	PAT40-04060005-3	63D-45577-20	GRUESO 0.15 mm	SHIM 0.15 mm	SPESSORE 0.15 mm	CALE 0.15 mm
28	PAT40-04060005-4	63D-45577-30	GRUESO 0.18 mm	SHIM 0.18 mm	SPESSORE 0.18 mm	CALE 0.18 mm
	PAT40-04060005-5	63D-45577-40	GRUESO 0.30 mm	SHIM 0.30 mm	SPESSORE 0.30 mm	CALE 0.30 mm
	PAT40-04060005-6	63D-45577-50	GRUESO 0.40 mm	SHIM 0.40 mm	SPESSORE 0.40 mm	CALE 0.40 mm
	PAT40-04060005-7	63D-45577-60	GRUESO 0.50 mm	SHIM 0.50 mm	SPESSORE 0.50 mm	CALE 0.50 mm
29	REC93306-001U1	93306-001U1	COJINETE	BEARING	CUSCINETTO	ROULEMENT
30	REC93210-69MG6	93210-69MG6	TÓRICA	O-RING	O-RING	JOINT TORIQUE
31	REC93210-74MG5	93210-74MG5	TÓRICA	O-RING	O-RING	JOINT TORIQUE
32	REC63D-45361-02-4D	63D-45361-02-8D	DIÁBOLO	CAP, LOWER CASING	COPERCHIO CARTER INFERIORE	COUVERCLE, POMPE D'EAU
33	REC93317-22204	93317-22204	COJINETE	BEARING	CUSCINETTO	ROULEMENT
34	REC93101-22M00	93101-22M00	RETÉN DE ACEITE	OIL SEAL	PARAOLIO	JOINT SPI
35	REC663-45987-00	663-45987-02	ESPACIADOR	SPACER	DISTANZIALE	ENTRETOISE
36	REC66T-45997-00	66T-45997-00	ESPACIADOR	SPACER	DISTANZIALE	ENTRETOISE
37	REC90389-22M01	90389-22M01	CASQUILLO HELICE	WASHER	GHIERA ELICA	RONDELLE D'HELICE
38	REC90171-16011	90171-16011	TUERCA	LOCK NUT	DADO	ÉCROU
39	REC91490-30025	91490-30025	PASADOR	PIN	SPINOTTO	PIN

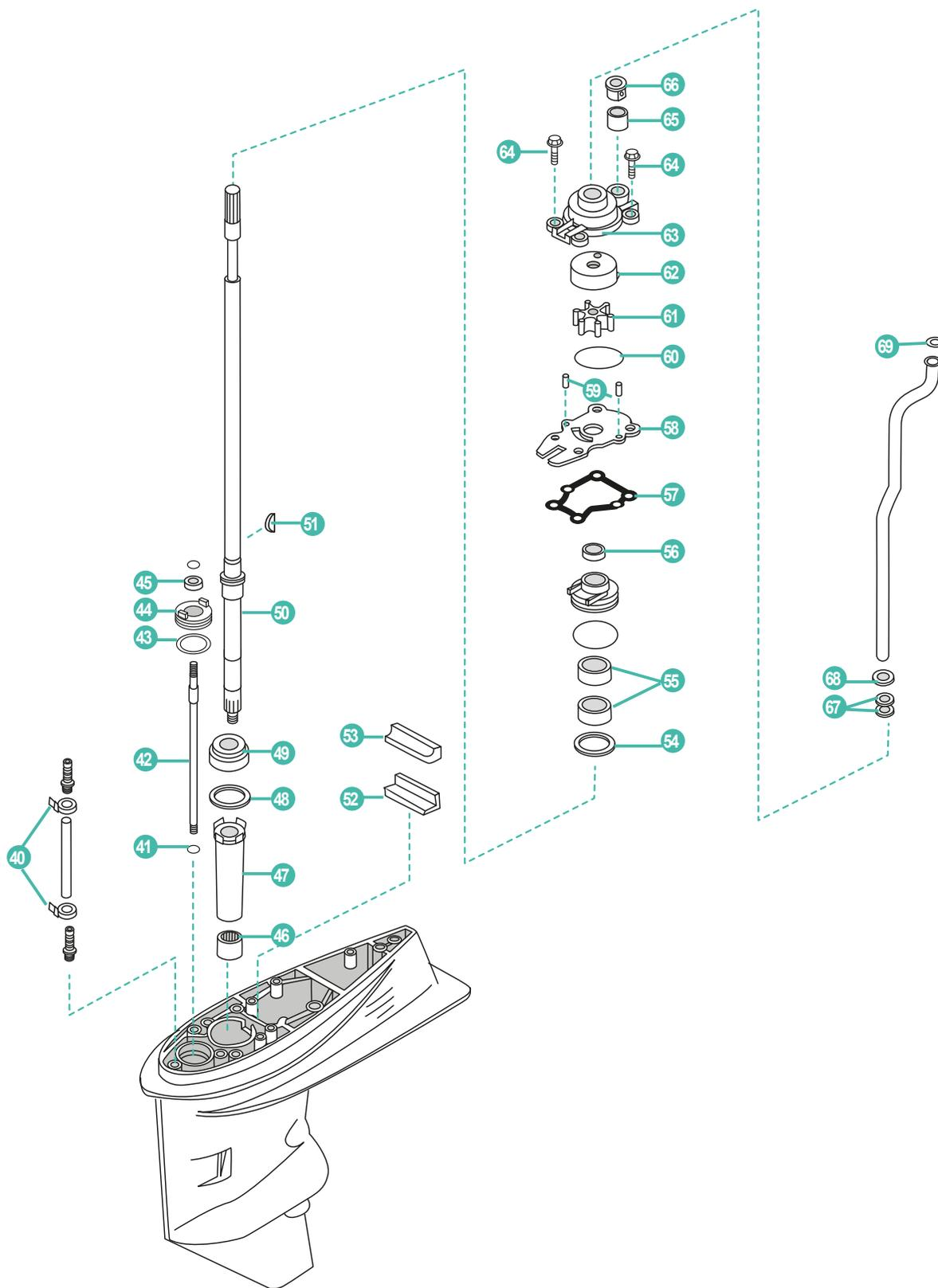

	REF	OEM				
40	PAHT-2.5X60	90465-11M10	BRIDA	CLAMP	FLANGIA	COLLIER
41	REC99001-08600-00	99001-08600	ARANDELA	WASHER	RONDELLA	RONDELLE
42	PA60-04000004	63D-44144-00	VARILLA DE CAMBIO	SHIFTING CAM	ASTA CAMBIO	LEVIER DE VITESSE
43	REC93210-33MG4	93210-33MG4	TÓRICA	O-RING	O-RING	JOINT TORIQUE
44	PAF60-04000101	63D-45321-00	PLACA	COVER, SHIFTING CAM	PACCA	SUPPORT
45	REC93106-09014	93106-09014	RETÉN DE ACEITE	OIL SEAL	PARAOLIO	JOINT SPI
46	REC93315-32224	93315-32224	COJINETE	BEARING	CUSCINETTO	ROULEMENT
47	PAT40-04000002	6H4-45536-00	CAMISA EJE	SLEEVE, DRIVE	TUBO GUIDA	RONDELLE
	PAT40-04000003-1	663-45587-01	GRUESO 0.10 mm	SHIM 0.10 mm	SPESSORE 0.10 mm	CALE 0.10 mm
	PAT40-04000003-2	663-45587-10	GRUESO 0.12 mm	SHIM 0.12 mm	SPESSORE 0.12 mm	CALE 0.12 mm
	PAT40-04000003-3	663-45587-20	GRUESO 0.15 mm	SHIM 0.15 mm	SPESSORE 0.15 mm	CALE 0.15 mm
48	PAT40-04000003-4	663-45587-30	GRUESO 0.18 mm	SHIM 0.18 mm	SPESSORE 0.18 mm	CALE 0.18 mm
	PAT40-04000003-5	663-45587-40	GRUESO 0.30 mm	SHIM 0.30 mm	SPESSORE 0.30 mm	CALE 0.30 mm
	PAT40-04000003-6	663-45587-50	GRUESO 0.40 mm	SHIM 0.40 mm	SPESSORE 0.40 mm	CALE 0.40 mm
	PAT40-04000003-7	663-45587-60	GRUESO 0.50 mm	SHIM 0.50 mm	SPESSORE 0.50 mm	CALE 0.50 mm
49	REC93332-00001	93332-00001	COJINETE	BEARING	CUSCINETTO	ROULEMENT
50	REC67C-45501-10	67C-45501-10	EJE VERTICAL L	DRIVE SHAFT L	ASSE VERTICALE L	ARBRE DE COMMANDE L
	REC67C-45501-00	67C-45501-00	EJE VERTICAL S	DRIVE SHAFT S	ASSE VERTICALE S	ARBRE DE COMMANDE S
51	REC90280-03M03	90280-03M03	CUÑA	KEY WOODRUFF	CHIAVETTA	CLAVETTE
52	REC663-45376-00	663-45376-00	GUÍA SELLO DE GOMA	GUIDE RUB. SEAL	GUIDA PARAOLIO	GUIDE EN CAOUTCHOUC
53	PAT40-04000014	63D-45375-00	SELLO DE GOMA	WATER ENVELOP	PARAOLIO	SUPPORT EN CAOUTCHOUC
54	PAT40-04000008	90201-27M00	ARANDELA	WASHER	RONDELLA	RONDELLE
55	REC93101-22M60	93101-22M60	RETÉN DE ACEITE	OIL SEAL	PARAOLIO	JOINT SPI
56	PAT40-04000009	66T-45344-01	CUBIERTA SELLO DE ACEITE	COVER, OIL SEAL	PARAOLIO	BAGUE EN CAOUTCHOUC
57	REC63D-44316-00	63D-44316-00	JUNTA	GASKET	GUARNIZIONE	JOINT
58	REC63D-44323-00	63D-44323-00	PLACA EXTERIOR	OUTER PLATE	PLACCA ESTERIORE	PLAQUE DE POMPE À EAU
59	PAF25-04000007	93604-08062	PASADOR	PIN	SPINOTTO	PIN
60	REC93210-59MG7	93210-59MG7	TÓRICA	O-RING	O-RING	JOINT TORIQUE
61	REC6H4-44352-02	6H4-44352-02	TURBINA	IMPELLER	GIRANTE	TURBINE
62	REC63D-44322-00	63D-44322-00	TAPA, BOMBA AGUA	COVER, INNER WATER PUMP	COPERCHIO, POMPE D'EAU	INSERT DE POMPE À EAU
63	PAT40-04000201	66T-44311-00	CUERPO BOMBA AGUA	HOUSING, WATER PUMP	CORPO POMPA	CORPS DE POMPE À EAU
64	REC90119-08M15	90119-08M15	TORNILLO CON ARANDELA	SCREW WITH WASHER	VITE CON RONDELLA	VIS PLUS RONDELLE
65	REC663-44366-00	663-44366-00	GOMA DEL SELLO DE AGUA	DAMPER, WATER SEAL	PARAOLIO	TUBE DE POMPE À EAU
66	REC63D-44312-00	63D-44312-00	CUBIERTA CAJA DE BOMBA DE AGUA	PUMP COVER	COPERCHIO CASSA POMPA ACQUA	BAGUE DE POMPE À EAU
67	PAT40-02000002	663-44367-00	GOMA DEL SELLO DE AGUA	DAMPER, WATER SEAL	PARAOLIO	JOINT
68	REC90430-12072	90430-12072	JUNTA	GASKET	GUARNIZIONE	JOINT
69	PAF25-02000019	90202-12060	ARANDELA PLANA	WASHER	RONDELLA PIANA	RONDELLE

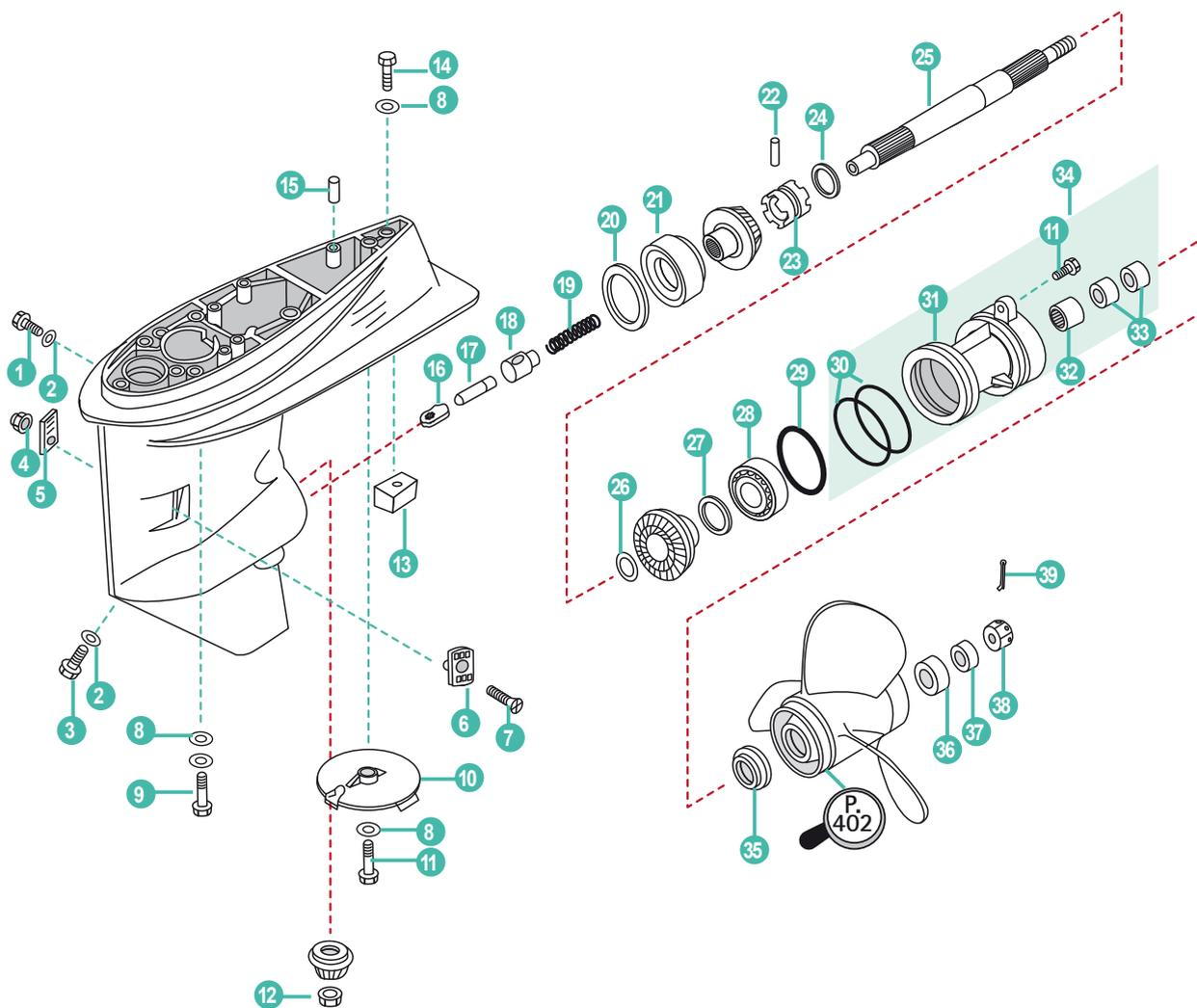

REF	OEM
REC62Y-W0001-22	62Y-W0001-22
P. 146	

REF	OEM
REC63D-W0078-01	63D-W0078-01
P. 151	

REF	
REC80W90U3	
REC80W90U6	
RECGREU1	
RECGREU12	
P. 43	

	REF	OEM				
1	REC90340-08002	90340-08002	TORNILLO DRENAJE	BOLT, DISCHARGING OIL	VITE DRENAGGIO	BOUCHON DE VIDANGE
2	REC90430-08020	90430-08003	JUNTA	GASKET	GUARNIZIONE	JOINT
3	REC688-45341-00	688-45341-10	TORNILLO DRENAJE	BOLT, DISCHARGING OIL	VITE DRENAGGIO	BOUCHON DE VIDANGE
4	PAGB/T889.1-M5	95380-05600	TUERCA	LOCK NUT	DADO	ÉCROU
5	PAT40-04000023	63D-45215-00	CUBIERTA ENTRADA AGUA B	WATER INLET B	COPERCHIO ACQUA B	GRILLE D'ENTREE D'EAU B
6	PAT40-04000022	63D-45214-00	CUBIERTA ENTRADA AGUA A	WATER INLET A	COPERCHIO ACQUA A	GRILLE D'ENTREE D'EAU A
7	PAGB/T820-M5X30	90152-05M06	TORNILLO	SCREW	VITE	VIS
8	PAGB/T97.1-8	92995-10600	ARANDELA	WASHER	RONDELLA	RONDELLE
9	REC97075-10040	97075-10040	PERNO	STUD	BULLONE	BOULON
10	CM67C-45371-00A	67C-45371-00	ÁNODO	ANODE	ANODO	ANODE
11	PAGB/T5783-M8X25	97095-08025	PERNO	STUD	BULLONE	BOULON
12	REC90170-12138	90170-12138	TUERCA	LOCK NUT	DADO	ÉCROU
13	CM67C-45251-00A	67C-45251-00	ÁNODO	ANODE	ANODO	ANODE
14	PAGB/T5783-M8X35	97095-08035	PERNO	STUD	BULLONE	BOULON
15	REC93606-12019	93606-12019	PASADOR	PIN	SPINOTTO	PIN
16	PAF60-04000003	62Y-44151-00	LEVA DE CAMBIO	SHIFTING CAM	LEVA DE CAMBIO	CAME DE CHANGEMENT
17	PAF60-04020005	63D-45635-00	ÉMBOLO	PLUNGER	BULLONE	BOUCHON
18	REC663-45634-00	663-45634-00	DESILIZADOR DEL CAMBIO	CLUTCH DOG	TRAINABILE CAMBIO	PIVOT
19	PAF60-04020002	90501-18001	MUELLE	SPRING	MOLLA	RESSORT
	PAT40-04000004-1	663-45567-01	GRUESO 0.10 mm	SHIM 0.10 mm	SPESSORE 0.10 mm	CALE 0.10 mm
20	PAT40-04000004-2	663-45567-10	GRUESO 0.12 mm	SHIM 0.12 mm	SPESSORE 0.12 mm	CALE 0.12 mm
	PAT40-04000004-3	663-45567-20	GRUESO 0.15 mm	SHIM 0.15 mm	SPESSORE 0.15 mm	CALE 0.15 mm
	PAT40-04000004-5	663-45567-40	GRUESO 0.30 mm	SHIM 0.30 mm	SPESSORE 0.30 mm	CALE 0.30 mm
21	REC93332-00003	93332-00003	COJINETE	BEARING	CUSCINETTO	ROULEMENT
22	REC90250-06023	90250-06023	PASADOR	PIN	SPINOTTO	LEVIER
23	PAF60-04020003	62Y-45631-00	EMBRAGUE DE GARRA	CLUTCH DOG	SELETTORE	CRABOT
24	PAT40-04050005	67C-45633-00	ANILLO DEL PASADOR	ANNULAR SPRING, CLUTCH	PARAOLIO	RESSORT
25	PAF60-04020001	63D-45611-00	EJE HÉLICE	PROPELLER SHAFT	ASSE ELICA	ARBRE D'HELICE
26	REC90201-22429	90201-22429	ARANDELA	WASHER	RONDELLA	RONDELLE
	PAT40-04060005-2	63D-45577-10	GRUESO 0.12 mm	SHIM 0.12 mm	SPESSORE 0.12 mm	CALE 0.12 mm
	PAT40-04060005-3	63D-45577-20	GRUESO 0.15 mm	SHIM 0.15 mm	SPESSORE 0.15 mm	CALE 0.15 mm
27	PAT40-04060005-4	63D-45577-30	GRUESO 0.18 mm	SHIM 0.18 mm	SPESSORE 0.18 mm	CALE 0.18 mm
	PAT40-04060005-5	63D-45577-40	GRUESO 0.30 mm	SHIM 0.30 mm	SPESSORE 0.30 mm	CALE 0.30 mm
	PAT40-04060005-6	63D-45577-50	GRUESO 0.40 mm	SHIM 0.40 mm	SPESSORE 0.40 mm	CALE 0.40 mm
	PAT40-04060005-7	63D-45577-60	GRUESO 0.50 mm	SHIM 0.50 mm	SPESSORE 0.50 mm	CALE 0.50 mm
28	REC93306-001U1	93306-001U1	COJINETE	BEARING	CUSCINETTO	ROULEMENT
29	REC93210-69MG6	93210-69MG6	TÓRICA	O-RING	O-RING	JOINT TORIQUE
30	REC93210-74MG5	93210-74MG5	TÓRICA	O-RING	O-RING	JOINT TORIQUE
31	REC63D-45361-02-4D	63D-45361-02-4D	DIÁBOLO	CAP, LOWER CASING	COPERCHIO CARTER INFERIORE	DIABOLO
32	REC93317-22204	93317-22204	COJINETE	BEARING	CUSCINETTO	ROULEMENT
33	REC93101-22M00	93101-22M00	RETÉN DE ACEITE	OIL SEAL	PARAOLIO	JOINT SPI
34	PAF60-04030000	63D-45361-02-8D	FUNDA INFERIOR COMPLETA	COVER ASSY, LOWER CASING	COPERCHIO CARTER COMPLETA	DIABOLO COMPLET
35	REC663-45987-00	663-45987-02	ESPACIADOR	SPACER	DISTANZIALE	ENTRETOISE
36	REC66T-45997-00	667-45997-00	ESPACIADOR	SPACER	DISTANZIALE	ENTRETOISE
37	REC90389-22M01	90389-22M01	CASQUILLO HELICE	WASHER	GHIERA ELICA	RONDELLE D'HELICE
38	REC90171-16011	90171-16011	TUERCA	LOCK NUT	DADO	ÉCROU
39	REC91490-30025	91490-30025	PASADOR	PIN	SPINOTTO	CLAVETTE

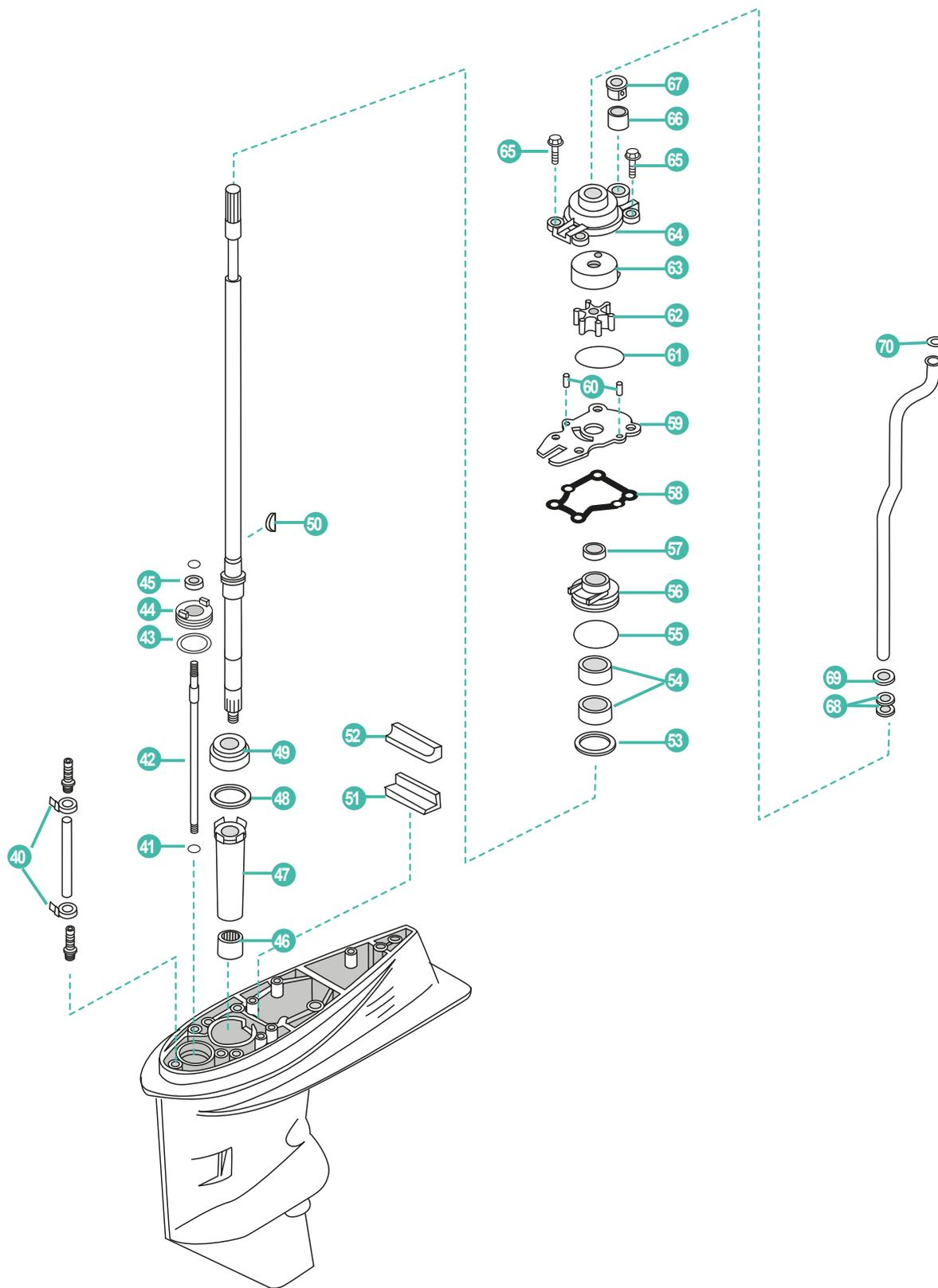

	REF	OEM				
40	PAHT-2.5X60	90465-11M10	BRIDA	CLAMP	FLANGIA	COLLIER
41	REC99001-08600-00	99001-08600	ARANDELA	WASHER	RONDELLA	RONDELLE
42	PA60-04000004	63D-44144-00	VARILLA DE CAMBIO	SHIFTING CAM	ASTA CAMBIO	LEVIER DE VITESSE
43	REC93210-33MG4	93210-33MG4	TÓRICA	O-RING	O-RING	JOINT TORIQUE
44	PAF60-04000101	63D-45321-00	PLACA	COVER, SHIFTING CAM	PLACCA	SUPPORT
45	REC93106-09014	93106-09014	RETÉN DE ACEITE	OIL SEAL	PARAOLIO	JOINT SPI
46	REC93315-32224	93315-32224	COJINETE	BEARING	CUSCINETTO	ROULEMENT
47	PAT40-04000002	6H4-45536-00	CAMISA EJE	SLEEVE, DRIVE	TUBO GUIDA	BAGUE NYLON
	PAT40-04000003-1	663-45587-01	GRUESO 0.10 mm	SHIM 0.10 mm	SPESSORE 0.10 mm	CALE 0.10 mm
	PAT40-04000003-2	663-45587-10	GRUESO 0.12 mm	SHIM 0.12 mm	SPESSORE 0.12 mm	CALE 0.12 mm
	PAT40-04000003-3	663-45587-20	GRUESO 0.15 mm	SHIM 0.15 mm	SPESSORE 0.15 mm	CALE 0.15 mm
48	PAT40-04000003-4	663-45587-30	GRUESO 0.18 mm	SHIM 0.18 mm	SPESSORE 0.18 mm	CALE 0.18 mm
	PAT40-04000003-5	663-45587-40	GRUESO 0.30 mm	SHIM 0.30 mm	SPESSORE 0.30 mm	CALE 0.30 mm
	PAT40-04000003-6	663-45587-50	GRUESO 0.40 mm	SHIM 0.40 mm	SPESSORE 0.40 mm	CALE 0.40 mm
	PAT40-04000003-7	663-45587-60	GRUESO 0.50 mm	SHIM 0.50 mm	SPESSORE 0.50 mm	CALE 0.50 mm
49	REC93332-00001	93332-00001	COJINETE	BEARING	CUSCINETTO	ROULEMENT
50	REC90280-03024	90280-03024	CUÑA	KEY WOODRUFF	CHIAVETTA	CLAVETTE
51	REC663-45376-00	663-45376-00-94	GUIÁ SELLO DE GOMA	GUIDE RUB SEAL	GUIDA PARAOLIO	GUIDE
52	PAT40-04000014	63D-45375-00	SELLO DE GOMA	WATER ENVELOP	PARAOLIO	PROTECTION TUYAU D'EAU
53	PAT40-04000008	90201-27M00	ARANDELA	WASHER	RONDELLA	RONDELLE
54	REC93101-25M57	93101-25M57	RETÉN DE ACEITE	OIL SEAL	PARAOLIO	JOINT SPI
55	REC93210-48MG8	93210-48MG8	TÓRICA	O-RING	O-RING	JOINT TORIQUE
56	REC63D-44341-00	63D-44341-00	CAJA DE BOMBA	HOUSING PUMP	CASSA POMPA	BOITIER DE POMPE À EAU
57	PAT40-04000009	66T-45344-01	CUBIERTA SELLO DE ACEITE	COVER SEAL OIL	COPERCHIO PARAOLIO	JOINT SPI
58	REC63D-44316-00	63D-44316-00	JUNTA	GASKET	GUARNIZIONE	JOINT
59	REC63D-44323-00	63D-44323-00	PLACA EXTERIOR	OUTER PLATE	PIASTRA POMPA ACQUA	PLAQUE DE POMPE À EAU
60	PAF25-04000007	93604-08062	PASADOR	PIN	SPINOTTO	PIN
61	REC93210-59MG7	93210-59MG7	TÓRICA	O-RING	O-RING	JOINT TORIQUE
62	REC6H4-44352-02	6H4-44352-00	TURBINA	IMPELLER	GIRANTE	TURBINE
63	REC63D-44322-00	63D-44322-00	TAPA, BOMBA AGUA	COVER, INNER WATER PUMP	COPERCHIO, POMPA ACQUA	INSERT DE POMPE À EAU
64	REC63D-44311-01	63D-44311-00	CUERPO BOMBA AGUA	HOUSING, WATER PUMP	CORPO POMPA	CORPS DE POMPE À EAU
65	REC90119-08M15	90119-08M15	TORNILLO CON ARANDELA	SCREW WITH WASHER	VITE CON RONDELLA	VIS AVEC RONDELLE
66	REC663-44366-00	663-44366-00	GOMA DEL SELLO DE AGUA	GUIDE BUSHING, WATER PIPE	PARAOLIO	MAUCHON CAOUTCHOUC DE PIPE D'EAU
67	REC63D-44312-00	63D-44312-00	CUBIERTA CAJA DE BOMBA DE AGUA	PUMP COVER	COPERCHIO CORPO ACQUA	PLAQUE POMPE À EAU
68	PAT40-02000002	663-44367-00	GOMA DEL SELLO DE AGUA	GUIDE BUSHING, WATER PIPE	PARAOLIO	JOINT CAHOUTCHOUC
69	REC90430-12072	90430-12072	JUNTA	GASKET	GUARNIZIONE	JOINT
70	PAF25-02000019	90202-12060	ARANDELA PLANA	WASHER	RONDELLA PIANA	RONDELLE

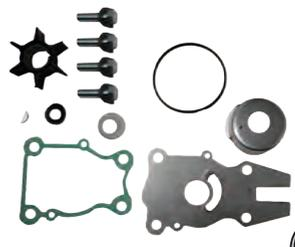
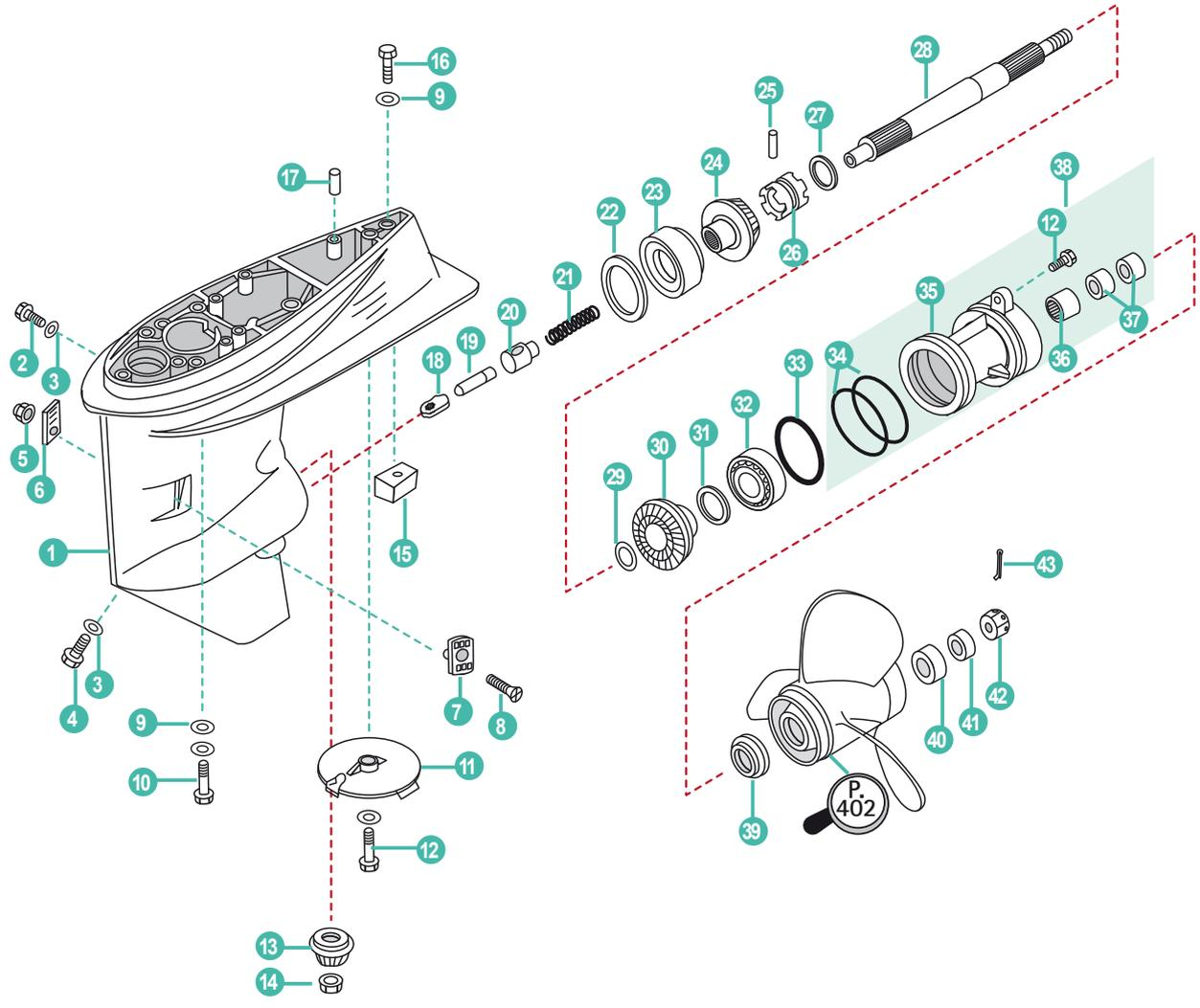

REF	OEM
REC63D-W0078-01	63D-W0078-01

P.151



REF
REC80W90U3
REC80W90U6
RECGREU1
RECGREU12

P.43



	REF	OEM			
	PAF60-04000000	69W-45300-04-8D COLA COMPLETA L	COMPLETE GEAR HOUSING L	PIEDE COMPLETO L	EMBASE COMPLETE L
1	PAF60-04000001	69W-45301-00-8D CARCASA COMPLETA	LOWER CASING	CARCASSA COMPLETA	CARTER D'EMBASE
2	REC90340-08002	90340-08002 TORNILLO DRENAJE	BOLT, DISCHARGING OIL	VITE DRENAGGIO	BOUCHON DE VIDANGE
3	REC90430-08020	90430-08003 JUNTA	GASKET	GUARNIZIONE	JOINT
4	REC688-45341-00	688-45341-10 TORNILLO DRENAJE	BOLT, DISCHARGING OIL	VITE DRENAGGIO	VIS DE VIDANGE
5	PAGB/T889.1-M5	95380-05600 TUERCA	LOCK NUT	DADO	ÉCROU
6	PAT40-04000023	63D-45215-00 CUBIERTA ENTRADA AGUA B	WATER INLET B	COPERCHIO ACQUA B	GRILLE D'ENTREE D'EAU B
7	PAT40-04000022	63D-45214-00 CUBIERTA ENTRADA AGUA A	WATER INLET A	COPERCHIO ACQUA A	GRILLE D'ENTREE D'EAU A
8	PAGB/T820-M5X30	90152-05010 TORNILLO	SCREW	VITE	VIS
9	PAGB/T97.1-8	92995-10600 ARANDELA	WASHER	RONDELLA	RONDELLE
10	REC97075-10040	97075-10040 PERNO	STUD	BULLONE	BOULON
11	CM67C-45371-00A	67C-45371-00 ÁNODO	ANODE	ANODO	ANODE
12	PAGB/T5783-M8X25	97095-08025 PERNO	STUD	BULLONE	BOULON
13	PAF60-04000002	69W-45551-00 PIÑÓN ATAQUE	INITIATIVE GEAR	MARCIA INIZIATIVA	PIGNON D'ATTAQUE
14	REC90170-12138	90170-12138 TUERCA	LOCK NUT	DADO	ÉCROU
15	CM67C-45251-00A	67C-45251-00 ÁNODO	ANODE	ANODO	ANODE
16	PAGB/T5783-M8X35	97095-08035 PERNO	STUD	BULLONE	BOULON
17	REC93606-12019	93606-12019 PASADOR	PIN	SPINOTTO	PIN
18	PAF60-04000003	62Y-44151-00 LEVA DE CAMBIO	SHINFTING CAM	LEVA DE CAMBIO	CAME DE CHANGEMENT
19	PAF60-04020005	63D-45635-00 ÉMBOLO	PLUNGER	BULLONE	BOUCHON
20	REC663-45634-00	663-45634-00 DESLIZADOR DEL CAMBIO	CLUTCH DOG	TRAINABILE CAMBIO	PIVOT
21	PAF60-04020002	90501-18001 MUELLE	SPRING	MOLLA	RESSORT
	PAT40-04000004-1	663-45567-01 GRUESO 0.10 mm	SHIM 0.10 mm	SPESSORE 0.10 mm	CALE 0.10 mm
	PAT40-04000004-2	663-45567-10 GRUESO 0.12 mm	SHIM 0.12 mm	SPESSORE 0.12 mm	CALE 0.12 mm
	PAT40-04000004-3	663-45567-20 GRUESO 0.15 mm	SHIM 0.15 mm	SPESSORE 0.15 mm	CALE 0.15 mm
	PAT40-04000004-5	663-45567-40 GRUESO 0.30 mm	SHIM 0.30 mm	SPESSORE 0.30 mm	CALE 0.30 mm
23	PAKOYOH1-CAP322/32	93332-00092 COJINETE	BEARING	CUSCINETTO	ROULEMENT
24	PAF60-04000600	69W-45560-00 PIÑÓN MARCHA AVANTE	POSITIVE GEAR ASSY	PIGNONE MARCIA AVANTI	PIGNON DE MARCHE AVANT
25	REC90250-06023	90250-06023 PASADOR	PIN	SPINOTTO	LEVIER
26	PAF60-04020003	62Y-45631-00 EMBRAGUE DE GARRA	CLUTCH DOG	SELETTORE	CRABOT
27	PAT40-04050005	67C-45633-00 ANILLO DEL PASADOR	ANNULAR SPRING, CLUTCH	PARAOLIO	RESSORT
28	PAF60-04020001	63D-45611-00 EJE HÉLICE	PROPELLER SHAFT	ASSE ELICA	ARBRE D'HELICE
29	PAT40-04050007	90201-22008 ARANDELA	WASHER	RONDELLA	RONDELLE
30	PAF60-04000500	62Y-45571-00 PIÑÓN MARCHA ATRÁS	REVERSE GEAR	PIGNONE MARCIA INDIETRO	PIGNON MARCHE ARRIÈRE
	PAT40-04060005-2	63D-45577-10 GRUESO 0.12 mm	SHIM 0.12 mm	SPESSORE 0.12 mm	CALE 0.12 mm
	PAT40-04060005-3	63D-45577-20 GRUESO 0.15 mm	SHIM 0.15 mm	SPESSORE 0.15 mm	CALE 0.15 mm
	PAT40-04060005-4	63D-45577-30 GRUESO 0.18 mm	SHIM 0.18 mm	SPESSORE 0.18 mm	CALE 0.18 mm
	PAT40-04060005-5	63D-45577-40 GRUESO 0.30 mm	SHIM 0.30 mm	SPESSORE 0.30 mm	CALE 0.30 mm
	PAT40-04060005-6	63D-45577-50 GRUESO 0.40 mm	SHIM 0.40 mm	SPESSORE 0.40 mm	CALE 0.40 mm
	PAT40-04060005-7	63D-45577-60 GRUESO 0.50 mm	SHIM 0.50 mm	SPESSORE 0.50 mm	CALE 0.50 mm
32	REC93306-001U1	93306-001U1 COJINETE	BEARING	CUSCINETTO	ROULEMENT
33	REC93210-69MG6	93210-69MG6 TÓRICA	O-RING	O-RING	JOINT TORIQUE
34	REC93210-74MG5	93210-74MG5 TÓRICA	O-RING	O-RING	JOINT TORIQUE
35	REC63D-45361-02-8D	63D-45361-02-8D DIÁBOLO	CAP, LOWER CASING	COPERCHIO CARTER INFERIORE	COUVERCLE, POMPE D'EAU
36	REC93317-22204	93317-22204 COJINETE	BEARING	CUSCINETTO	PALIER
37	REC93101-22M00	93101-22M00 RETÉN DE ACEITE	OIL SEAL	PARAOLIO	JOINT SPI
38	PAF60-04030000	63D-45361-02-8D FUNDA INFERIOR COMPLETA	COVER ASSY, LOWER CASING	COPERCHIO CARTER COMPLETA	COUVERCLE INFERIEUR EMBASE
39	REC663-45987-00	663-45987-02 ESPACIADOR	SPACER	DISTANZIALE	ENTRETOISE
40	REC66T-45997-00	667-45997-00 ESPACIADOR	SPACER	DISTANZIALE	ENTRETOISE
41	REC90389-22M01	90389-22M01 CASQUILLO HÉLICE	WASHER	GHIERA ELICA	RONDELLE D'HELICE
42	REC90171-16011	90171-16011 TUERCA	LOCK NUT	DADO	ÉCROU
43	REC91490-30025	91490-30025 PASADOR	PIN	SPINOTTO	CLAVETTE

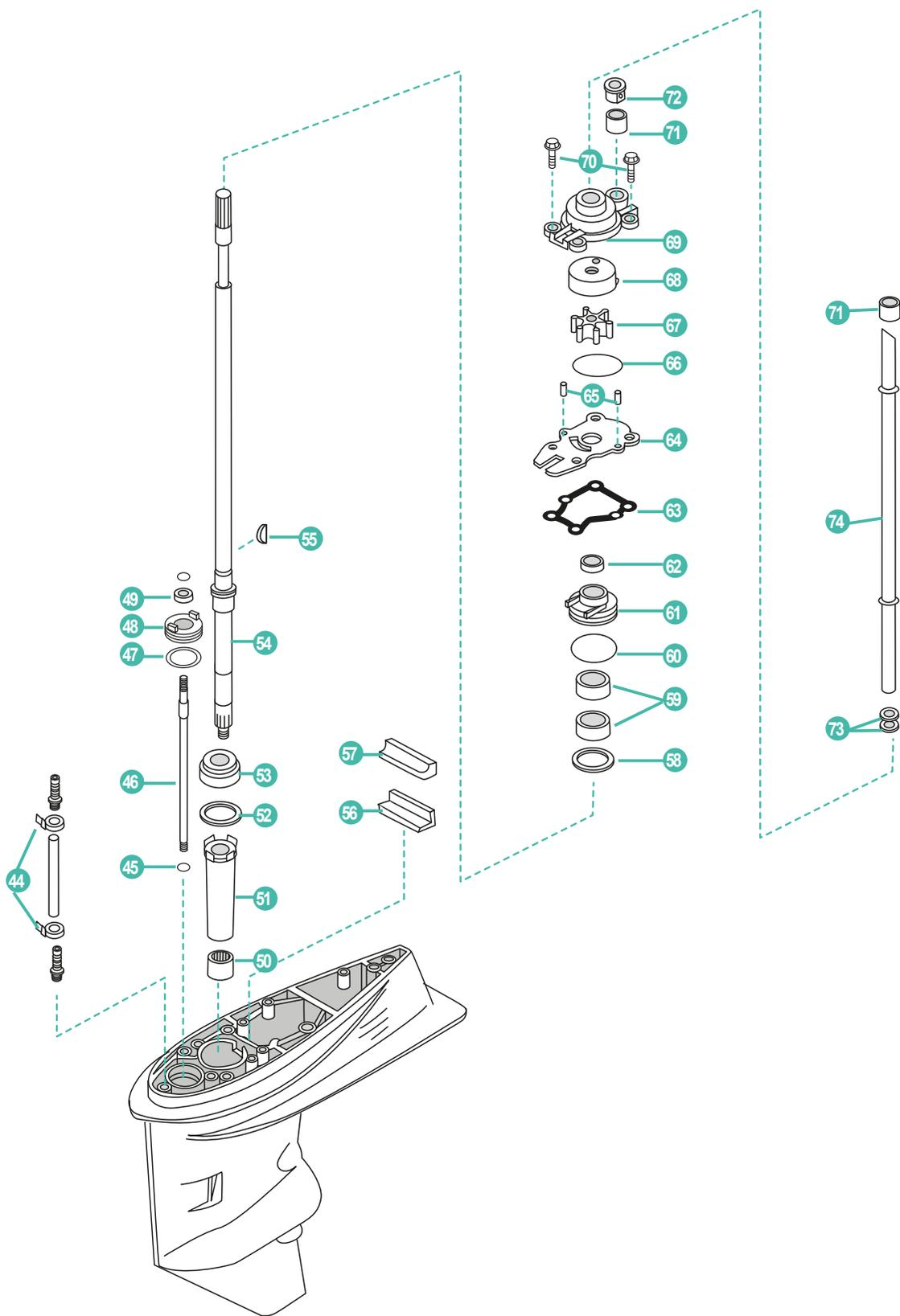

	REF	OEM				
44	PAHT-2.5X60	90465-11M10	BRIDA	CLAMP	FLANGIA	COLLIER
45	REC99001-08600-00	99001-08600	ARANDELA	WASHER	RONDELLA	RONDELLE
46	PA60-04000004	63D-44144-00	VARILLA DE CAMBIO	SHIFTING CAM	ASTICELLA DEL CAMBIO	CAME DE CHANGEMENT
47	REC93210-33MG4	93210-33MG4	TÓRICA	O-RING	O-RING	JOINT TORIQUE
48	PAF60-04000101	63D-45321-00	PLACA	COVER, SHIFTING CAM	PLACCA	SUPPORT
49	REC93106-09014	93106-09014	RETÉN DE ACEITE	OIL SEAL	PARAOLIO	JOINT SPI
50	REC93315-32224	93315-32224	COJINETE	BEARING	CUSCINETTO	PALIER
51	PAT40-04000002	6H4-45536-00	CAMISA EJE	SLEEVE, DRIVE	TUBO GUIDA	RONDELLE
	PAT40-04000003-1	663-45587-01	GRUESO 0.10 mm	SHIM 0.10 mm	SPESSORE 0.10 mm	CALE 0.10 mm
	PAT40-04000003-2	663-45587-10	GRUESO 0.12 mm	SHIM 0.12 mm	SPESSORE 0.12 mm	CALE 0.12 mm
	PAT40-04000003-3	663-45587-20	GRUESO 0.15 mm	SHIM 0.15 mm	SPESSORE 0.15 mm	CALE 0.15 mm
52	PAT40-04000003-4	663-45587-30	GRUESO 0.18 mm	SHIM 0.18 mm	SPESSORE 0.18 mm	CALE 0.18 mm
	PAT40-04000003-5	663-45587-40	GRUESO 0.30 mm	SHIM 0.30 mm	SPESSORE 0.30 mm	CALE 0.30 mm
	PAT40-04000003-6	663-45587-50	GRUESO 0.40 mm	SHIM 0.40 mm	SPESSORE 0.40 mm	CALE 0.40 mm
	PAT40-04000003-7	663-45587-60	GRUESO 0.50 mm	SHIM 0.50 mm	SPESSORE 0.50 mm	CALE 0.50 mm
53	REC93332-00001	93332-00001	COJINETE	BEARING	CUSCINETTO	ROULEMENT
54	PAF60-04010000	69W-45501-00	EJE VERTICAL COMPLETO	DRIVE SHAFT	ASSE VERTICALE	ARBRE DE COMMANDE
55	REC90280-03024	90280-03024	CUÑA	KEY WOODRUFF	CHIAVETTA	CLAVETTE
56	REC663-45376-00	663-45376-00-94	GUÍA SELLO DE GOMA	GUIDE RUB. SEAL	GUIDA PARAOLIO	GUIDE
57	PAT40-04000014	63D-45375-00	SELLO DE GOMA	WATER ENVELOP	PARAOLIO	PROTECTION TUYAU D'EAU
58	PAT40-04000008	90201-27M00	ARANDELA	WASHER	RONDELLA	RONDELLE
59	REC93101-25M57	93101-25M57	RETÉN DE ACEITE	OIL SEAL	PARAOLIO	JOINT SPI
60	PAJASOF40424-050	93210-48001	TÓRICA	O-RING	O-RING	JOINT TORIQUE
61	PAT40-04040001	6BG-44341-00	CAJA DE BOMBA	CASING A, OIL SEAL	CASSA POMPA	LOGEMENT JOINT SPI
62	PAF60-04000008	63D-45344-00	CUBIERTA SELLO DE ACEITE	COVER, OIL SEAL	PARAOLIO	COUVERTURE JOINT D'HUILE
63	REC63D-44316-00	63D-44316-00	JUNTA	GASKET	GUARNIZIONE	JOINT
64	REC63D-44323-00	63D-44323-00	PLACA EXTERIOR	WATER PLATE	PLACCA ESTERNA	PLAQUE DE POMPE À EAU
65	PAF25-04000007	93604-08062	PASADOR	PIN	SPINOTTO	LEVIER
66	REC93210-59MG7	93210-59MG7	TÓRICA	O-RING	O-RING	JOINT TORIQUE
67	REC6H3-44352-00	6H3-44352-00	TURBINA	IMPELLER	GIRANTE	TURBINE
68	REC63D-44322-00	63D-44322-00	TAPA, BOMBA AGUA	COVER, INNER WATER PUMP	COPERCHIO, POMPE D'EAU	INSERT DE POMPE À EAU
69	REC63D-44311-01	63D-44311-00	CUERPO BOMBA AGUA	HOUSING, WATER PUMP	CORPO POMPA	CORPS DE POMPE À EAU
70	REC90119-08M15	90119-08M15	TORNILLO CON ARANDELA	SCREW WITH WASHER	VITE CON RONDELLA	VIS AVEC RONDELLE
71	REC663-44366-00	663-44366-00	GOMA DEL SELLO DE AGUA	GUIDE BUSHING, WATER PIPE	PARAOLIO	GUIDE CAOUTCHOUC
72	REC63D-44312-00	63D-44312-00	CUBIERTA CAJA DE BOMBA DE AGUA	PUMP COVER	COPERCHIO CORPO ACQUA	PLAQUE POMPE À EAU
73	PAT40-02000002	663-44367-00	GOMA DEL SELLO DE AGUA	GUIDE BUSHING, WATER PIPE	PARAOLIO	JOINT CAOUTCHOUC
74	PAF60-02000007	6C5-44361-00	TUBO DE AGUA	WATER TUBE	TUBO DELL'ACQUA	DURITE D'EAU

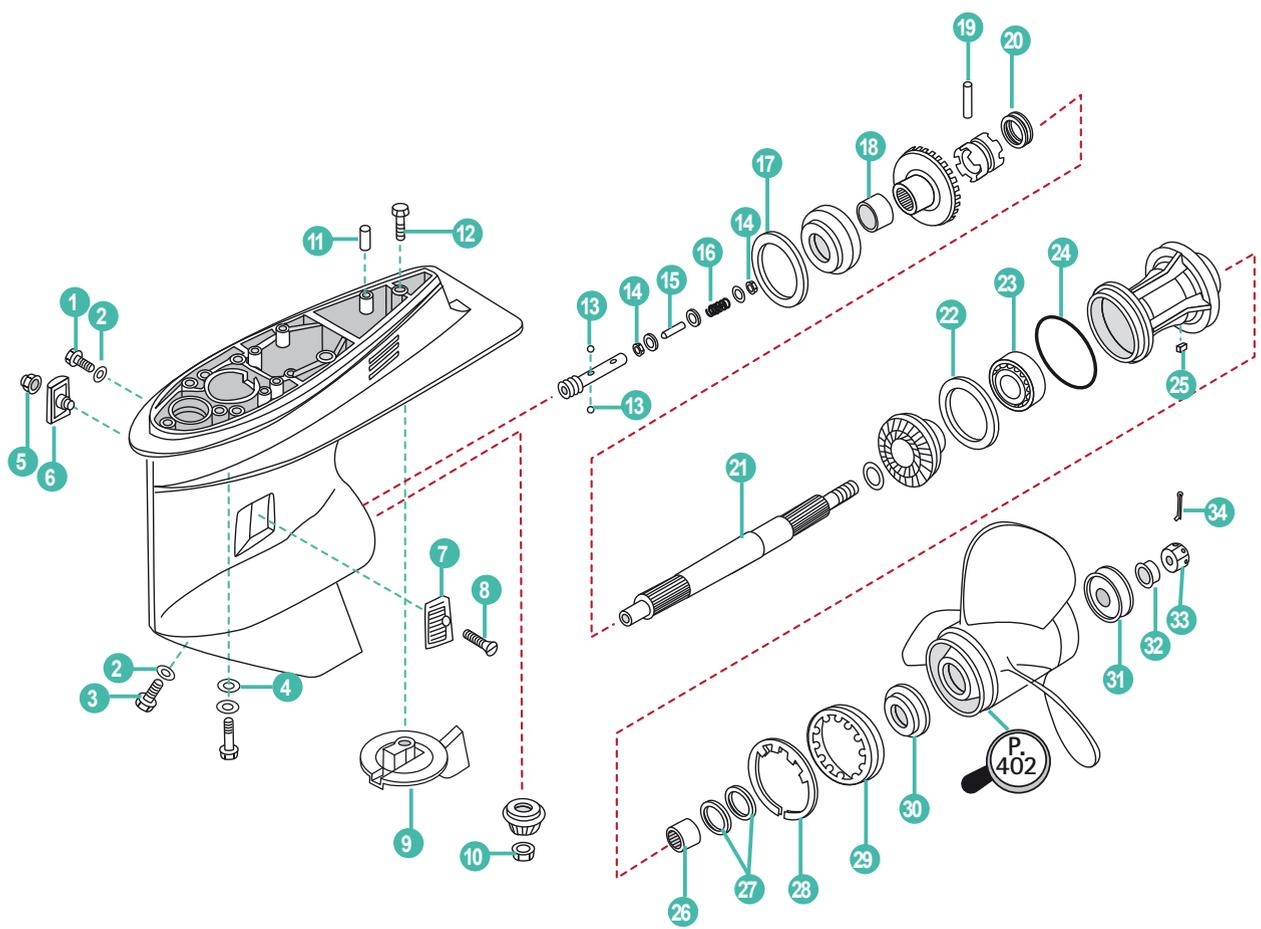

REF	OEM
REC6CJ-W0078-00	6CJ-W0078-00

P. 151

REF
REC80W90U3
REC80W90U6
RECGREU1
RECGREU12

P. 43

	REF	OEM				
1	REC90340-08002	90340-08002	TORNILLO DRENAJE	BOLT, DISCHARGING OIL	VITE DRENAGGIO	BOUCHON DE VIDANGE
2	REC90430-08020	90430-08003	JUNTA	GASKET	GUARNIZIONE	JOINT
3	REC688-45341-00	688-45341-10	TORNILLO DRENAJE	BOLT, DISCHARGING OIL	VITE DRENAGGIO	BOUCHON DE VIDANGE
4	PAGB/T97.1-8	92995-10600	ARANDELA	WASHER	RONDELLA	RONDELLE
5	PAGB/T6182-M5	90185-05002	TUERCA	LOCK NUT	DADO	ÉCROU
6	REC6H1-45215-00	6H1-45215-00	CUBIERTA ENTRADA AGUA B	WATER INLET B	COPERCHIO ACQUA B	GRILLE D'ENTREE D'EAU B
7	REC6H1-45214-00	6H1-45214-00	CUBIERTA ENTRADA AGUA A	WATER INLET A	COPERCHIO ACQUA A	GRILLE D'ENTREE D'EAU A
8	REC90151-05M00	90152-05000	TORNILLO	SCREW	VITE	VIS
9	CM67F-45371-00A	67F-45371-00	ÁNODO	ANODE	ANODO	ANODE
10	REC90170-16M01	90170-16M01	TUERCA	LOCK NUT	DADO	ÉCROU
11	REC93606-12019	93606-12019	PASADOR	PIN	SPINOTTO	LEVIER
12	PAT85-00000012	90105-16M67	PERNO	STUD	BULLONE	BOULON
13	REC93503-16003	93503-16003	ESFERA	BALL	SFERA	BILLE
14	REC90183-02M03	90183-02M03	TUERCA	LOCK NUT	DADO	ÉCROU
15	REC6H1-45668-00	6H1-45668-00	EJE DEL ÉMBOLO	FREE SHAFT	BULLONE	ARBRE
16	REC90501-12M48	90501-12M48	MUELLE	SPRING	MOLLA	RESSORT
17	PAT85-04000004-B	688-45567-01	GRUESO 0.10 mm	SHIM 0.10 mm	SPESSORE 0.10 mm	CALE 0.10 mm
18	REC93317-322V0	93317-322V0	COJINETE	BEARING	CUSCINETTO	PALIER
19	REC90250-07M02	90250-07M02	PASADOR	PIN	SPINOTTO	LEVIER
20	REC688-45633-00	688-45633-00	ANILLO DEL PASADOR	ANNULAR SPRING, CLUTCH	PARAOLIO	RESSORT
21	REC67F-45611-01	67F-45611-01	EJE HÉLICE	PROPELLER SHAFT	ASSE ELICA	ARBRE D'HELICE
22	REC67F-45576-00	67F-45576-00	ARANDELA	WASHER	RONDELLA	RONDELLE
23	REC93306-207U0	93306-207U0	COJINETE	BEARING	CUSCINETTO	PALIER
24	REC93210-86M39	93210-86M39	TÓRICA	O-RING	O-RING	JOINT TORIQUE
25	REC90282-04010	90282-04010	CHAVETA RECTA	KEY	CHIAVETTA	CLAVETTE
26	REC93317-325U0	93317-325U0	COJINETE	BEARING	CUSCINETTO	PALIER
27	REC93101-25M03	93101-25M03	RETÉN DE ACEITE	OIL SEAL	PARAOLIO	JOINT SPI
28	REC688-45383-01	688-45383-02	ARANDELA	WASHER	RONDELLA	RONDELLE
29	REC688-45384-00	688-45384-02	TUERCA	NUT	DADO	ÉCROU
30	REC688-45987-00	688-45987-01	ESPACIADOR	SPACER	DISTANZIALE	ENTRETOISE
31	REC67F-45997-00	67F-45997-00	ESPACIADOR	SPACER	DISTANZIALE	ENTRETOISE
32	REC90389-25M00	90389-25M00	CASQUILLO HÉLICE	WASHER	GHIERA ELICA	RONDELLE D'HELICE
33	REC90171-16011	90171-16011	TUERCA	LOCK NUT	DADO	ÉCROU
34	REC91490-30025	91490-30025	PASADOR	PIN	SPINOTTO	CLAVETTE

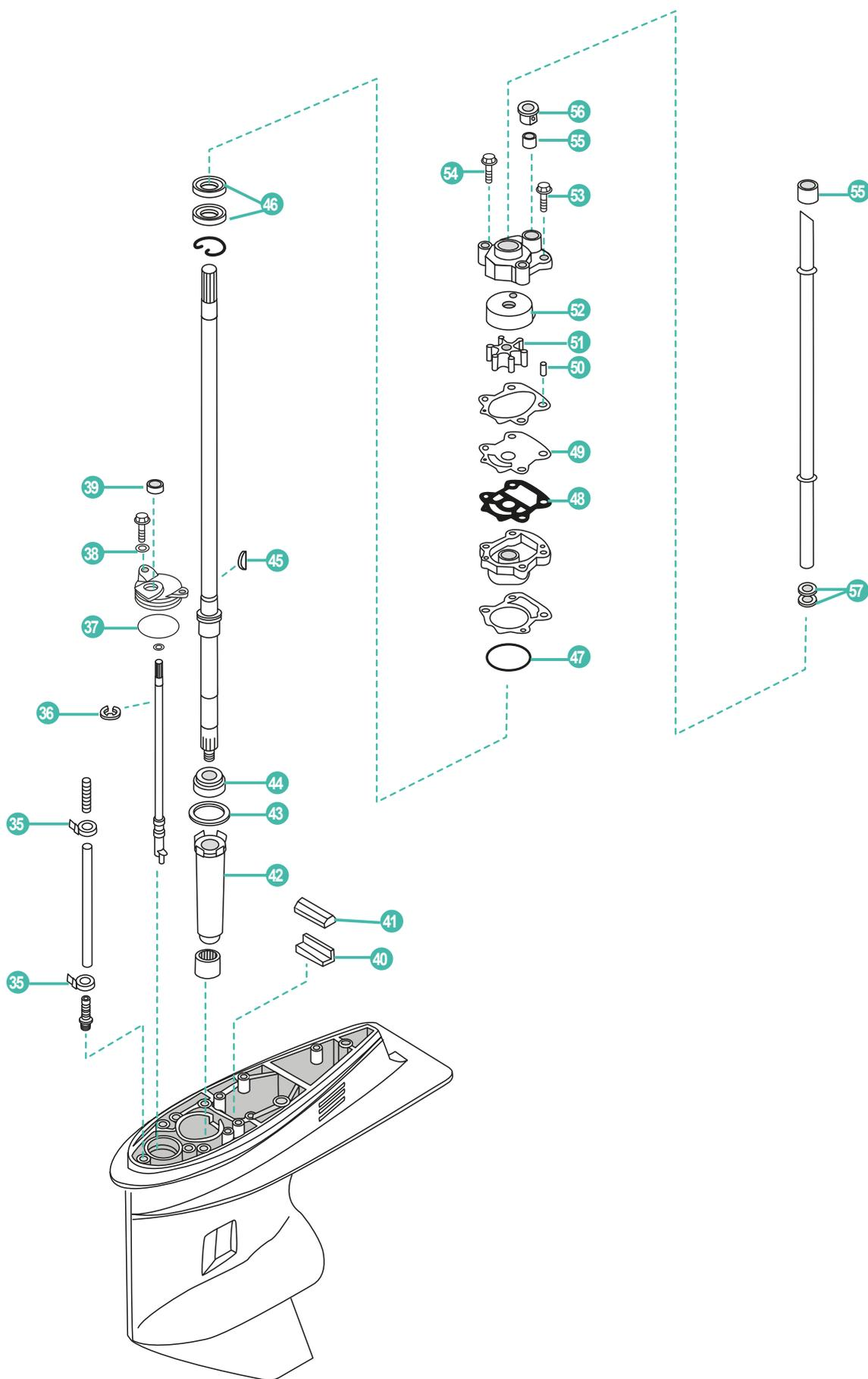

	REF	OEM				
35	PAHT-2.5X60	90465-11M10	BRIDA	CLAMP	FLANGIA	COLLIER
36	REC99001-08600-00	99001-08600	ARANDELA	WASHER	RONDELLA	RONDELLE
37	REC93210-49046	93210-49046	TÓRICA	O-RING	O-RING	JOINT TORIQUE
38	PAGB/T97.1-6	92995-06600	ARANDELA	WASHER	RONDELLA	RONDELLE
39	REC93106-09014	93106-09014	RETÉN DE ACEITE	OIL SEAL	PARAOLIO	JOINT SPI
40	REC663-45376-00	663-45376-00-94	GUÍA SELLO DE GOMA	GUIDE RUB. SEAL	GUIDA PARAOLIO	GUIDE
41	REC688-45375-00	63D-45375-00	RETEN DAMPER	DAMPER WASHER	PARAOLIO DAMPER	JOINT SILENT BLOC
42	REC688-45536-01	688-45536-01	CAMISA EJE	SLEEVE, DRIVE	TUBO GUIDA	RONDELLE
43	PAT85-040000003-B	688-45587-01	GRUESO 0.10 mm	SHIM 0.10 mm	SPESSORE 0.10 mm	CALE 0.10 mm
44	REC93332-000U3	93332-000U3	COJINETE	BEARING	CUSCINETTO	ROULEMENT
45	REC90280-03M03	90280-03M03	CUÑA	KEY WOODRUFF	CHIAVETTA	CLAVETTE
46	REC93101-23070	93101-23070	RETÉN DE ACEITE	OIL SEAL	PARAOLIO	JOINT SPI
47	REC93210-46044	93210-46044	TÓRICA	O-RING	O-RING	JOINT TORIQUE
48	REC6CJ-44324-00	6CJ-44324-00	JUNTA	GASKET	GUARNIZIONE	JOINT
49	REC6CJ-44323-00	6CJ-44323-00	PLACA EXTERIOR	OUTER PLATE, CARTRIDGE	COPERCHIO POMPA D'ACQUA	PLAQUE DE POMPE À EAU
50	PAF15-00000013	93604-10M03	PASADOR	PIN	SPINOTTO	PIN
51	REC6H3-44352-00	6H3-44352-00	TURBINA	IMPELLER	GIRANTE	TURBINE
52	REC63D-44322-00	63D-44322-00	TAPA, BOMBA AGUA	COVER, INNER WATER PUMP	COPERCHIO, POMPA ACQUA	INSERT DE POMPE À EAU
53	REC90119-08M14	90119-08M14	TORNILLO CON ARANDELA	SCREW WITH WASHER	VITE CON RONDELLA	VIS AVEC RONDELLE
54	REC90119-08M33	90119-08M33	TORNILLO CON ARANDELA	SCREW WITH WASHER	VITE CON RONDELLA	VIS AVEC RONDELLE
55	REC663-44366-00	663-44366-00	GOMA DEL SELLO DE AGUA	DAMPER, WATER SEAL	GHIERA	JOINT DE TUBE D'EAU
56	REC63D-44312-00	63D-44312-00	CUBIERTA CAJA DE BOMBA DE AGUA	PUMP COVER	COPERCHIO CORPO ACQUA	PLAQUE POMPE À EAU
57	PAT40-02000002	663-44367-00	GOMA DEL SELLO DE AGUA	GUIDE BUSHING, WATER PIPE	PARAOLIO	JOINT CAOUTCHOUC

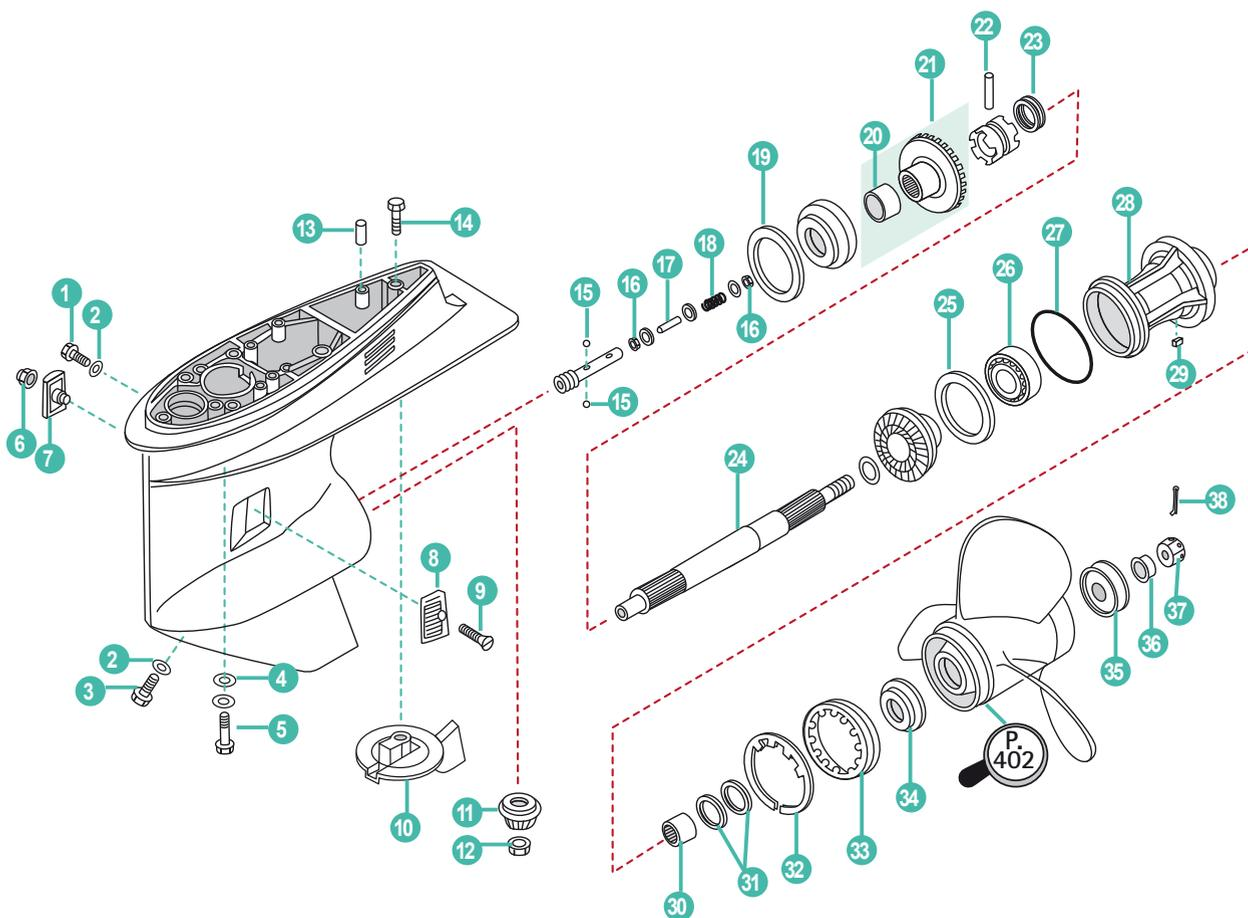

REF	OEM
REC67F-W0001-20	67F-W0001-20

P. 145



REF	OEM
REC67F-W0078-00	67F-W0078-00

P. 152



REF
REC80W90U3
REC80W90U6
RECGREU1
RECGREU12

P. 43



	REF	OEM				
1	REC90340-08002	90340-08002	TORNILLO DRENAJE	BOLT, DISCHARGING OIL	VITE DRENAGGIO	BOUCHON DE VIDANGE
2	REC90430-08020	90430-08003	JUNTA	GASKET	GUARNIZIONE	JOINT
3	REC688-45341-00	688-45341-10	TORNILLO DRENAJE	BOLT, DISCHARGING OIL	VITE DRENAGGIO	BOUCHON DE VIDANGE
4	PAGB/T97.1-8	92995-10600	ARANDELA	WASHER	RONDELLA	RONDELLE
5	REC97075-10040	97075-10040	PERNO	STUD	BULLONE	BOULON
6	PAGB/T6182-M5	90185-05002	TUERCA	LOCK NUT	DADO	ÉCROU
7	REC6H1-45215-00	6H1-45215-00	CUBIERTA ENTRADA AGUA B	WATER INLET B	COPERCHIO ACQUA B	GRILLE D'ENTREE D'EAU B
8	REC6H1-45214-00	6H1-45214-00	CUBIERTA ENTRADA AGUA A	WATER INLET A	COPERCHIO ACQUA A	GRILLE D'ENTREE D'EAU A
9	REC90151-05M00	90152-05000	TORNILLO	SCREW	VITE	VIS
10	CM67F-45371-00A	67F-45371-00	ÁNODO	ANODE	ANODO	ANODE
11	REC6D9-45551-00	6D9-45551-00	PIÑÓN ATAQUE	INITIATIVE GEAR	MARCIA INIZIATIVA	PIGNON D'ATTAQUE
12	REC90170-16M01	90170-16M01	TUERCA	LOCK NUT	DADO	ÉCROU
13	REC93606-12019	93606-12019	PASADOR	PIN	SPINOTTO	PIN
14	PAT85-00000012	90105-16M67	PERNO	STUD	BULLONE	BOULON
15	REC93503-16003	93503-16003	ESFERA	BALL	SFERA	BILLE
16	REC90183-02M03	90183-02M03	TUERCA	LOCK NUT	DADO	ÉCROU
17	REC6H1-45668-00	6H1-45668-00	EJE DEL ÉMBOLO	FREE SHAFT	BULLONE	ARBRE
18	REC90501-12M48	90501-12M48	MUELLE	SPRING	MOLLA	RESSORT
19	PAT85-040000004-B	688-45567-01	GRUESO 0.10 mm	SHIM 0.10 mm	SPESSORE 0.10 mm	CALE 0.10 mm
20	REC93317-322V0	93317-322V0	COJINETE	BEARING	CUSCINETTO	ROULEMENT
21	REC67F-45560-00	67F-45560-00	PIÑÓN MARCHA AVANTE	POSITIVE GEAR ASSY	PIGNONE MARCIA AVANTI	PIGNON DE MARCHE AVANT
22	REC90250-07M02	90250-07M02	PASADOR	PIN	SPINOTTO	PIN
23	REC688-45633-00	688-45633-00	ANILLO DEL PASADOR	ANNULAR SPRING, CLUTCH	PARAOLIO	RESSORT
24	REC67F-45611-01	67F-45611-01	EJE HÉLICE	PROPELLER SHAFT	ASSE ELICA	ARBRE D'HELICE
25	REC67F-45576-00	67F-45576-00	ARANDELA	WASHER	RONDELLA	RONDELLE
26	REC93306-207U0	93306-207U0	COJINETE	BEARING	CUSCINETTO	ROULEMENT
27	REC93210-86M39	93210-86M39	TÓRICA	O-RING	O-RING	JOINT TORIQUE
28	REC67F-45331-00-CA	67F-45331-00-94	DIÁBOLO	BEARING	DIABOLO	DIABOLO
29	REC90282-04010	90282-04010	CHAVETA RECTA	KEY	CHIAVETTA	CHAVETTE
30	REC93317-325U0	93317-325U0	COJINETE	BEARING	CUSCINETTO	PALIER
31	REC93101-25M03	93101-25M03	RETÉN DE ACEITE	OIL SEAL	PARAOLIO	JOINT SPI
32	REC688-45383-01	688-45383-02	ARANDELA	WASHER	RONDELLA	RONDELLE
33	REC688-45384-00	688-45384-02	TUERCA	NUT	DADO	ÉCROU
34	REC688-45987-00	688-45987-01	ESPACIADOR	SPACER	DISTANZIALE	ENTRETOISE
35	REC67F-45997-00	67F-45997-00	ESPACIADOR	SPACER	DISTANZIALE	ENTRETOISE
36	REC90389-25M00	90389-25M00	CASQUILLO HÉLICE	WASHER	GHIERA ELICA	RONDELLE D'HELICE
37	REC90171-16011	90171-16011	TUERCA	LOCK NUT	DADO	ÉCROU
38	REC91490-40030	91490-40025	PASADOR	PIN	SPINOTTO	CLAVETTE

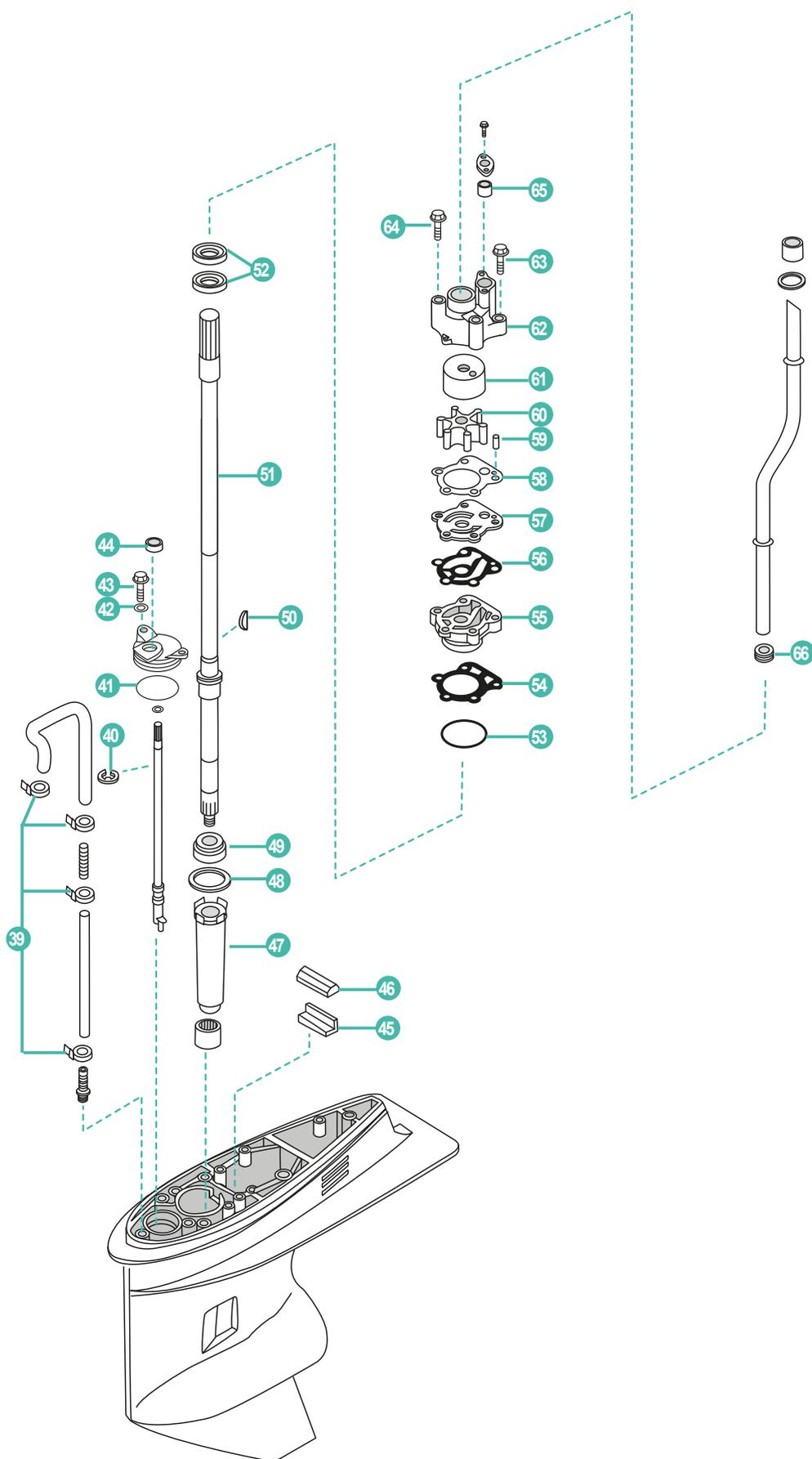

	REF	OEM				
39	PAHT-2.5X60	90465-11M10	BRIDA	CLAMP	FLANGIA	COLLIER
40	REC99001-08600-00	99001-08600	ARANDELA	WASHER	RONDELLA	RONDELLE
41	REC93210-49046	93210-49046	TÓRICA	O-RING	O-RING	JOINT TORIQUE
42	PAGB/T97.1-6	92995-06600	ARANDELA	WASHER	RONDELLA	RONDELLE
43	PAGB/T5783-M6X16	97095-06016	PERNO HEXAGONAL	HEXAGON BOLT	BULLONE ESSAGONALE	BOULON HEXAGONAL
44	REC93106-09014	93106-09014	RETÉN DE ACEITE	OIL SEAL	PARAOLIO	JOINT SPI
45	REC663-45376-00	663-45376-00-94	GUÍA SELLO DE GOMA	GUIDE RUB. SEAL	GUIDA PARAOLIO	GUIDE
46	REC688-45375-00	63D-45375-00	RETEN DAMPER	DAMPER WASHER	PARAOLIO DAMPER	JOINT SILENT BLOC
47	REC688-45536-01	688-45536-01	CAMISA EJE	SLEEVE, DRIVE	TUBO GUIDA	RONDELLE
48	PAT85-040000003-B	688-45587-01	GRUESO 0.10 mm	SHIM 0.10 mm	SPESSORE 0.10 mm	CALE 0.10 mm
49	REC93332-000U3	93332-000U3	COJINETE	BEARING	CUSCINETTO	ROULEMENT
50	REC90280-04M04	90280-04M04	CUÑA	KEY WOODRUFF	CHIAVETTA	CLAVETTE
51	REC67F-45501-10	67F-45501-10	EJE VERTICAL L (21,1")	DRIVE SHAFT L (21,1")	ALBERO TRANSON L (21,1")	ARBRE VERTICAL L (21,1")
52	REC93101-25M03	93101-25M03	RETÉN DE ACEITE	OIL SEAL	PARAOLIO	JOINT SPI
53	REC93210-46044	93210-46044	TÓRICA	O-RING	O-RING	JOINT TORIQUE
54	REC688-44316-00	688-44316-00	JUNTA	GASKET	GUARNIZIONE	JOINT
55	REC688-44341-01	6D8-44341-01	CUERPO RETENES BOMBA DE AGUA	HOUSING WATER PUMP	CORPO POMPA	BASE DE POMPE À EAU
56	REC688-44324-00	688-44324-A0	JUNTA	GASKET	GUARNIZIONE	JOINT
57	REC67F-44323-00	67F-44323-00	PLACA EXTERIOR	WEAR PLATE	COPERCHIO	PLAQUE DE POMPE À EAU
58	REC688-44315-00	688-44315-A0	JUNTA	GASKET	GUARNIZIONE	JOINT
59	PAF25-04000007	93604-10M03	PASADOR	PIN	SPINOTTO	LEVIER
60	REC67F-44352-00	67F-44352-00	TURBINA	IMPELLER	GIRANTE	TURBINE
61	REC67F-44322-00	67F-44322-00	TAPA, BOMBA AGUA	COVER, INNER WATER PUMP	COPERCHIO, POMPE ACQUA	INSERT DE POMPE À EAU
62	REC67F-44311-01	67F-44311-00	CUERPO BOMBA AGUA	HOUSING, WATER PUMP	CORPO POMPA	CORPS DE POMPE À EAU
63	REC90119-08M13	90119-08M13	TORNILLO CON ARANDELA	SCREW WITH WASHER	VITE CON RONDELLA	VIS AVEC RONDELLE
64	REC90119-08M87	90119-08M87	TORNILLO CON ARANDELA	SCREW WITH WASHER	VITE CON RONDELLA	VIS AVEC RONDELLE
65	REC663-44366-00	663-44366-00	RETEN TUBO AGUA	DAMPER, WATER SEAL	GHIERA	JOINT DE TUBE D'EAU
66	PAT40-02000002	663-44367-00	GOMA DEL SELLO DE AGUA	GUIDE BUSHING, WATER PIPE	PARAOLIO	MAUCHON CAOUTCHOUC DE PIPE D'EAU

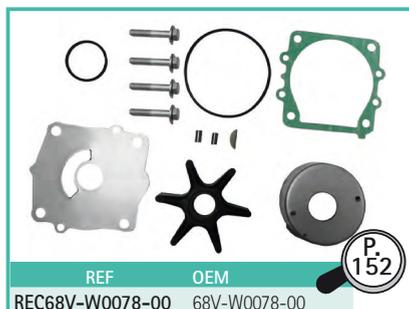
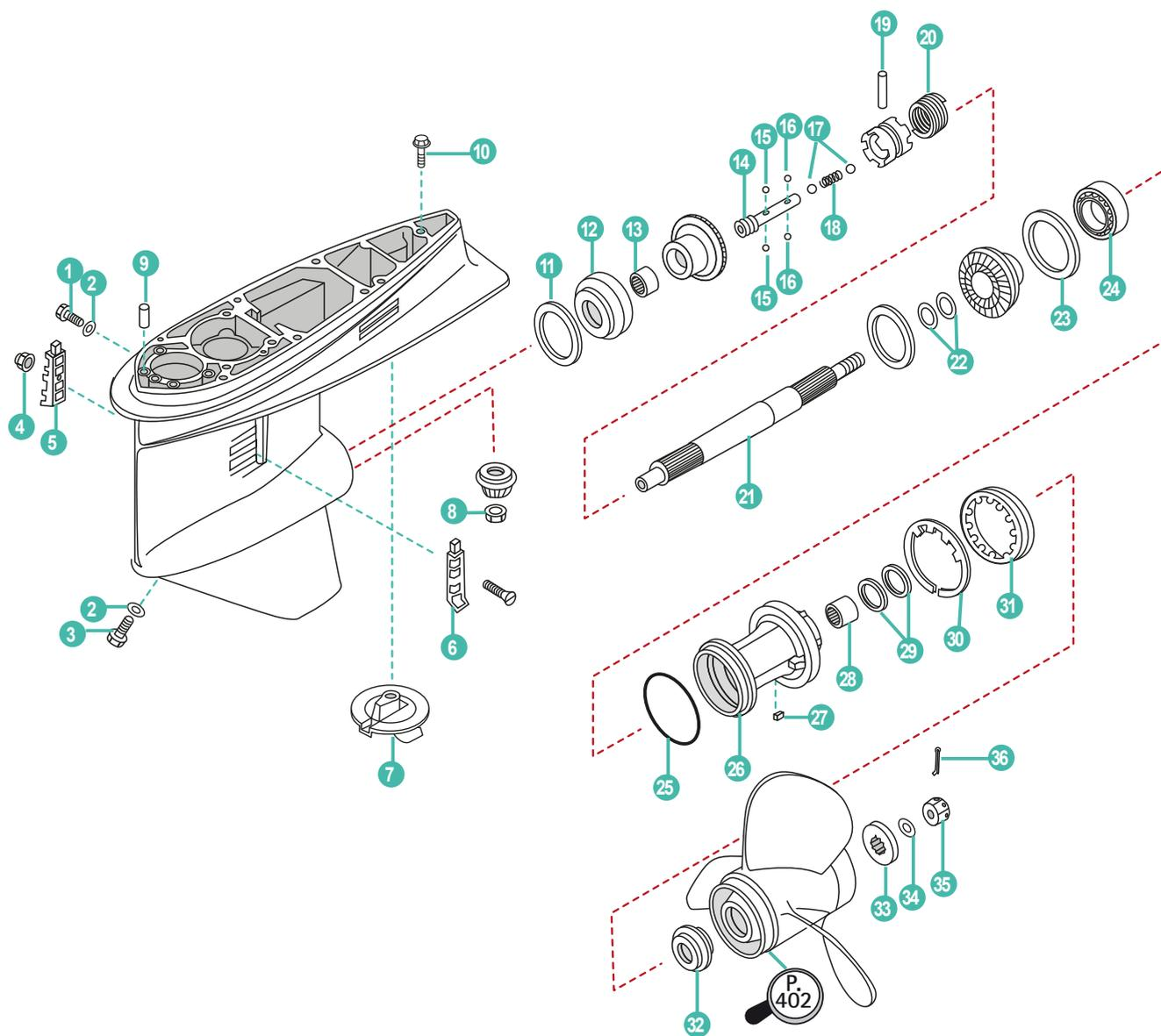

	REF	OEM				
1	REC90340-08002	90340-08002	TORNILLO DRENAJE	BOLT, DISCHARGING OIL	VITE DRENAGGIO	BOUCHON DE VIDANGE
2	REC90430-08020	90430-08003	JUNTA	GASKET	GUARNIZIONE	JOINT
3	REC688-45341-00	688-45341-10	TORNILLO DRENAJE	BOLT, DISCHARGING OIL	VITE DRENAGGIO	BOUCHON DE VIDANGE
4	PAGB/T6182-M5	90185-05002	TUERCA	LOCK NUT	DADO	ÉCROU
5	REC688-45215-02	688-45215-02	CUBIERTA ENTRADA AGUA B	WATER INLET B	COPERCHIO ACQUA B	GRILLE D'ENTREE D'EAU B
6	REC688-45214-02	688-45214-02	CUBIERTA ENTRADA AGUA A	WATER INLET A	COPERCHIO ACQUA A	GRILLE D'ENTREE D'EAU A
7	CM6E5-45371-01A	6E5-45371-00	ÁNODO	ANODE	ANODO	ANODE
8	REC90170-16M01	90170-16M01	TUERCA	LOCK NUT	DADO	ÉCROU
9	REC93608-12M05	93608-12M05	PASADOR	PIN	SPINOTTO	PIN
10	PAT85-00000012	90105-10M00	TORNILLO	SCREW	VITE	VIS
11	REC6E5-45567-01	6E5-45567-01	KIT GRUESOS 0.12 - 0.50 mm	SHIM SET 0.12 - 0.50 mm	KIT SPESSORI 0.12 - 0.50 mm	KIT CALES 0.12 - 0.50 mm
12	REC93332-000U7	93332-000U7	COJINETE	BEARING	CUSCINETTO	ROULEMENT
13	REC93315-425U7	93315-425U7	COJINETE	BEARING	CUSCINETTO	ROULEMENT
14	REC6E5-45634-01	6E5-45634-01	PASADOR DESPLAZABLE	SLIDE SHIFT	SPINOTTO SCORREVOLE	PIN REGLABLE
15	REC93507-32031	93507-32009	ESFERA	BALL	SFERA	BILLE
16	REC93503-16003	93503-16003	ESFERA	BALL	SFERA	BILLE
17	REC93511-32027	93511-32027	ESFERA	BALL	SFERA	BILLE
18	REC90501-16M37	90501-16M37	MUELLE	SPRING	MOLLA	RESSORT
19	REC90250-08M07	90250-08M07	PASADOR	PIN	SPINOTTO	LEVIER
20	REC6E5-45633-01	6E5-45633-01	ANILLO DEL PASADOR	ANNULAR SPRING, CLUTCH	ANELLO SELETTORE	RESSORT
21	REC6E5-45611-00	6E5-45611-00	EJE HÉLICE	PROPELLER SHAFT	ASSE ELICA	ARBRE D'HELICE
22	REC90201-30M92	90201-30M92	ARANDELA	WASHER	RONDELLA	RONDELLE
23	REC6E5-45576-00	6E5-45576-00	ARANDELA	WASHER	RONDELLA	RONDELLE
24	REC93306-208U0	93306-208U0	COJINETE	BEARING	CUSCINETTO	ROULEMENT
25	REC93210-86M39	93210-86M39	TÓRICA	O-RING	O-RING	JOINT TORIQUE
26	REC6E5-45332-00-94	6E5-45332-00-CA	DIÁBOLO	GEAR HOUSING	DIABOLO	DIABOLO
27	REC90282-04010	90282-04010	CHAVETA RECTA	KEY	CHIAVETTA	CHAVETTE
28	REC93315-430U8	93315-430U8	COJINETE	BEARING	CUSCINETTO	ROULEMENT
29	REC93101-30M17	93101-30M17	RETÉN DE ACEITE	OIL SEAL	PARAOLIO	JOINT SPI
30	REC688-45383-01	688-45383-02	ARANDELA	WASHER	RONDELLA	RONDELLE
31	REC688-45384-00	688-45384-02	TUERCA	NUT	DADO	ÉCROU
32	REC6E5-45987-00	63P-45987-00	ESPACIADOR	SPACER	DISTANZIALE	ENTRETOISE
33	REC688-45997-00	688-45997-01	ESPACIADOR	SPACER	DISTANZIALE	ENTRETOISE
34	REC92990-18200	92990-18200	ARANDELA	WASHER	RONDELLA	RONDELLE
35	REC90171-18M04	90171-18M04	TUERCA	LOCK NUT	DADO	ÉCROU
36	REC91490-40030	91490-40030	PASADOR	PIN	SPINOTTO	CLAVETTE

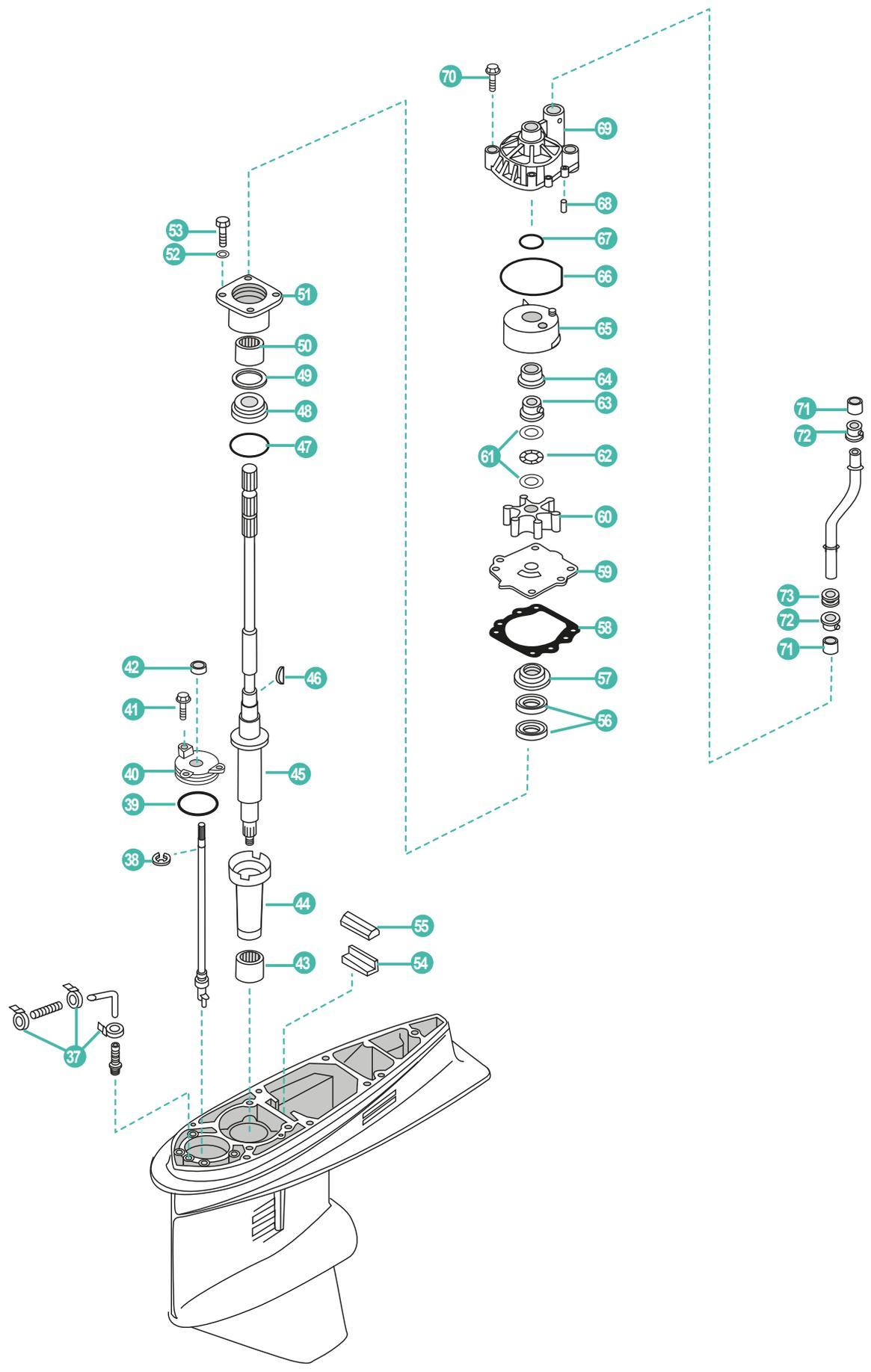

	REF	OEM				
37	PAHT-2.5X60	90465-11M10	BRIDA	CLAMP	FLANGIA	COLLIER
38	REC99001-08600-00	99001-08600	ARANDELA	WASHER	RONDELLA	RONDELLE
39	REC93210-58677	93210-58144	TÓRICA	O-RING	O-RING	JOINT TORIQUE
40	REC6E5-45321-00	6E5-45321-00	TAPA CAMBIO	PLATE	COPERCHIO CAMBIO	COUVERCLE
41	REC90119-06M10	90119-06M10	TORNILLO CON ARANDELA	SCREW WITH WASHER	VITE CON RONDELLA	VIS AVEC RONDELLE
42	REC93106-09014	93106-09014	RETÉN DE ACEITE	OIL SEAL	PARAOLIO	JOINT SPI
43	REC93315-628U9	93315-628U9	COJINETE	BEARING	CUSCINETTO	ROULEMENT
44	REC6E5-45536-00	6E5-45536-00	CAMISA EJE DE MANDO	SLEEVE	CAMICIA	BAGUE
45	REC68V-45501-10	68V-45501-10	EJE TRANSMISION L 20.3"	DRIVE SHAFT L 20.3"	ASSE TRASMISSIONE L 20,3"	ARBRE DE TRANSMISSION L 20,3"
46	REC90280-04M05	90280-04M05	CUÑA	KEY WOODRUFF	CHIAVETTA	CLAVETTE
47	REC93210-54534	93210-55M14	TÓRICA	O-RING	O-RING	JOINT TORIQUE
48	REC93341-930V2	93341-930V2	COJINETE	BEARING	CUSCINETTO	ROULEMENT
49	REC6E5-45587-01	6E5-45587-01	KIT GRUESOS 0.12 - 0.50 mm	SHIM SET 0.12 - 0.50 mm	KIT SPESSORI 0.12 - 0.50 mm	KIT CALES 0.12 - 50 mm
50	REC93317-330U2	93317-330U2	COJINETE	BEARING	CUSCINETTO	ROULEMENT
51	REC6E5-45331-00-94	6E5-45331-00-9S	DIÁBOLO	GEAR HOUSING	DIABOLO	DIABOLO
52	PAGB/T97.1-8	92995-08600	ARANDELA	WASHER	RONDELLA	RONDELLE
53	PAGB/T5783-M8X25	97095-08025	PERNO	BOLT	VOTE	BOULON
54	REC663-45376-00	663-45376-00	GUÍA SELLO DE GOMA	GUIDE RUB. SEAL	GUIDA PARAOLIO	GUIDE
55	REC688-45375-00	63D-45375-00	RETEN DAMPER	DAMPER WASHER	PARAOLIO DAMPER	JOINT SILENT BLOC
56	REC93101-28M16	93101-28M16	RETÉN DE ACEITE	OIL SEAL	PARAOLIO	JOINT SPI
57	REC6E5-45344-00	6E5-45344-00	TAPA RETEN	RETAINER	COPERCHIO PARAOLIO	RETENUE
58	REC6E5-44315-A0	6E5-44315-A0	JUNTA	GASKET	GUARNIZIONE	JOINT
59	REC68V-44323-00	6EK-44323-00	TAPA BOMBA	OUTER PLATE	COPERCHIO POMPA	PLAQUE DE POMPE À EAU
60	REC6E5-44352-01	6E5-44352-01	TURBINA	IMPELLER	GIRANTE	TURBINE
61	REC90201-22M01	90201-22M01	ARANDELA	WASHER	RONDELLA	RONDELLE
62	REC90206-22M19	90206-22M19	ARANDELA ONDULADA	WAVE WASHER	RONDELLA ONDULATA	RONDELLE
63	REC61A-45538-00	61A-45538-00	ESPACIADOR	SPACER	SPESSORE	ENTRETOISE
64	REC61A-45527-00	61A-45527-00	CASQUILLO CUERPO BOMBA	COLLAR	BOCCOLA CORPO POMPA	BAGUE POMPE À EAU
65	REC61A-44322-02	61A-44322-02	TAPA, BOMBA AGUA	COVER, INNER WATER PUMP	COPERCHIO, POMPE D'EAU	INSERT DE POMPE À EAU
66	REC93210-86M38	93210-86M38	TÓRICA	O-RING	O-RING	JOINT TORIQUE
67	REC93210-37160	93210-37160	TÓRICA	O-RING	O-RING	JOINT TORIQUE
68	REC93606-12019	93606-12019	PASADOR	PIN	SPINOTTO	LEVIER
69	REC61A-44311-00	61A-44311-01	CUERPO BOMBA AGUA	HOUSING, WATER PUMP	CORPO POMPA	CORPS DE POMPE À EAU
70	REC90119-08M14	90119-08M14	TORNILLO CON ARANDELA	SCREW WITH WASHER	VITE CON RONDELLA	VIS AVEC RONDELLE
71	REC6E5-44365-00	6E5-44365-00	GOMA DEL SELLO DE AGUA	DAMPER WATER TUBE	GUARNIZIONE	BAGUE DE TUBE D'EAU
72	REC6E5-44312-00	6E5-44312-00	CUBIERTA CAJA DE BOMBA DE AGUA	PUMP COVER	COPERCHIO CORPO ACQUA	PLAQUE POMPE À EAU
73	REC6E5-44366-00	6E5-44366-00	FLECTOR	DAMPER WATER SEAL	GUARNIZIONE	JOINT

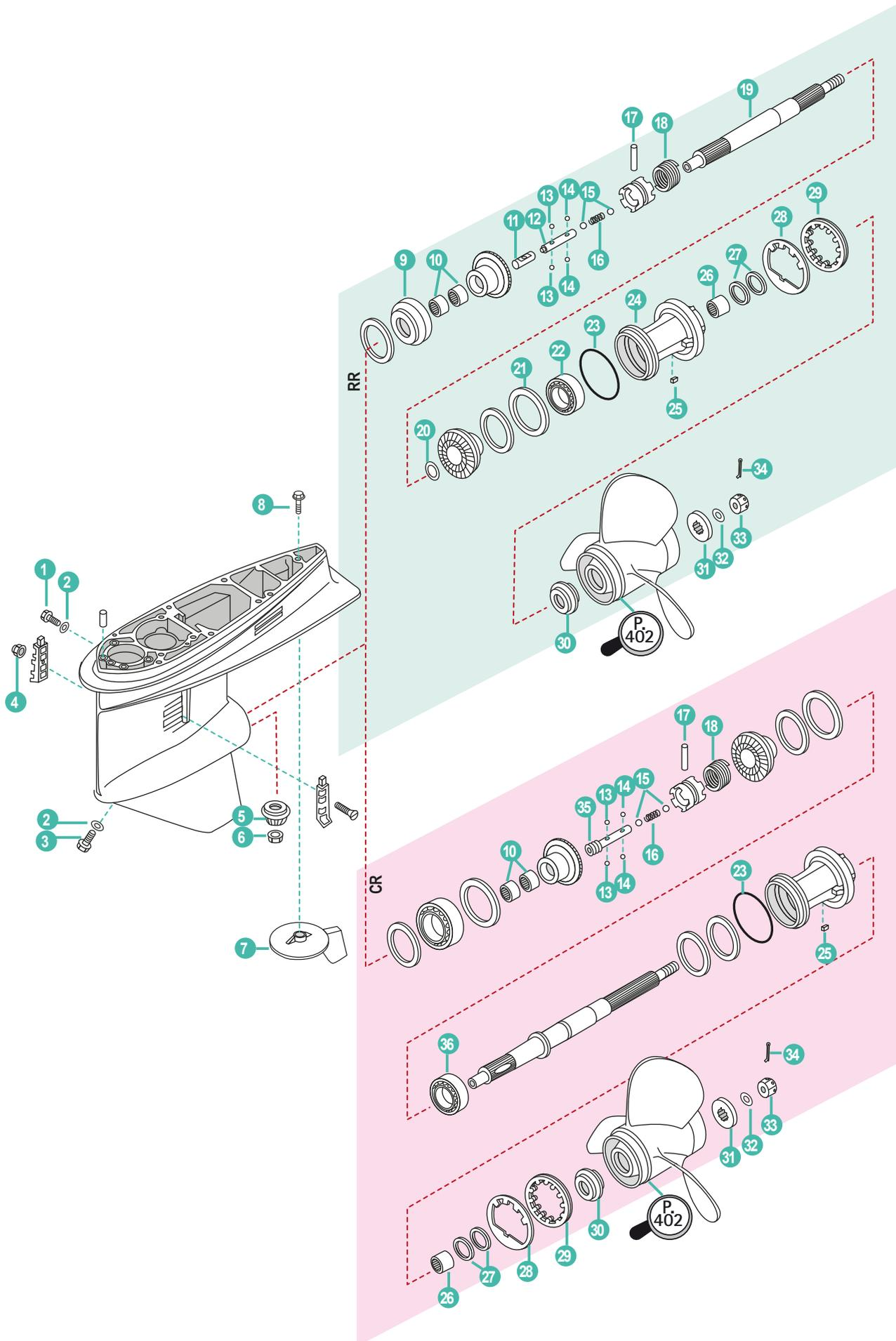



REF	OEM				
REC416-B20F	63P-45300-02-8D	CONJUNTO INFERIOR RR (L) SÓLO PARA F150	COMPLETE GEARCASE V6 (L) ONLY F150	PIEDE COMPLETO (L) SOLO F150	EMBASE COMPLETE (L) POUR F150
REC416-B25F	63P-45300-12-8D	CONJUNTO INFERIOR RR (X) SÓLO PARA F150	COMPLETE GEARCASE V6 (X) ONLY F150	PIEDE COMPLETO V6 (X) SOLO F150	EMBASE COMPLETE V6 (X) POUR F150
REC418-B25F	64P-45300-12-8D	CONJUNTO INFERIOR CR (X) SÓLO PARA F150	COMPLETE GEARCASE V6 CR (X) ONLY F150	PIEDE COMPLETE CR (X) FOLO F150	EMBASE COMPLETE CONTRE ROTATION (X) POUR F150
1 REC90340-08002	90304-08002	TORNILLO DRENAJE	BOLT, DISCHARGING OIL	VITE DRENAGGIO	BOUCHON DE VIDANGE
2 REC90430-08020	90430-08020	JUNTA	GASKET	GUARNIZIONE	JOINT
3 REC688-45341-00	688-45341-10	TORNILLO DRENAJE	BOLT, DISCHARGING OIL	VITE DRENAGGIO	BOUCHON DE VIDANGE
4 PAGB/T6182-M5	90185-05002	TUERCA	LOCK NUT	DADO	ÉCROU
5 REC63P-45551-00	63P-45551-00	PIÑÓN ATAQUE	INITIATIVE GEAR	MARCIA INIZIATIVA	PIGNON D'ATTAQUE
6 REC90170-16M01	90170-16M01	TUERCA	LOCK NUT	DADO	ÉCROU
7 CM6J9-45371-01A	6J9-45371-01	ÁNODO	ANODE	ANODO	ANODE
8 PAT85-00000012	90105-10M00	TORNILLO	SCREW	VITE	VIS
9 REC93332-000V3	93332-000V3	COJINETE	BEARING	CUSCINETTO	ROULEMENT
10 REC93315-425V3	93315-425V3	COJINETE	BEARING	CUSCINETTO	ROULEMENT
11 REC6E5-45641-03	6E5-45641-03	EJE	SHAFT	ASSE	ARBRE
12 REC6E5-45634-01	6E5-45634-01	PASADOR DESPLAZABLE	SLIDE SHIFT	SPINOTTO SCORREVOLE	PIN REGLABLE
13 REC93507-32031	93507-32009	ESFERA	BALL	SFERA	BILLE
14 REC93503-16003	93503-16003	ESFERA	BALL	SFERA	BILLE
15 REC93511-32027	93511-32017	ESFERA	BALL	SFERA	BILLE
16 REC90501-16M37	90501-16M37	MUELLE	SPRING	MOLLA	RESSORT
17 REC90250-08M07	90250-08M07	PASADOR	PIN	SPINOTTO	PIN
18 REC6E5-45633-01	6E5-45633-01	ANILLO DEL PASADOR	ANNULAR SPRING, CLUTCH	ANELLO	RESSORT
19 REC6J9-45611-00	6J9-45611-01	EJE HÉLICE	PROPELLER SHAFT	ASSE ELICA	ARBRE D'HELICE
20 REC90201-30M92	90201-30M92	ARANDELA	WASHER	RONDELLA	RONDELLE
21 REC6G5-45576-10	6G5-45576-10	ARANDELA EMPUJE	WASHER, THRUST	RONDELLA DI SPINTA	RONDELLE D'APPUI
22 REC93306-209U0	93306-209U0	COJINETE	BEARING	CUSCINETTO	ROULEMENT
23 REC93210-97M55	93210-97M55	TÓRICA	O-RING	O-RING	JOINT TORIQUE
24 REC6J9-45332-00-CA	6J9-45332-00-CA	DIÁBOLO	GEAR HOUSING	DIABOLO	DIABOLO
25 REC90282-04M00	90282-04M00	CHAVETA RECTA	KEY	CHIAVETTA	CLAVETTE
26 REC93315-43061	93315-43061	COJINETE	BEARING	CUSCINETTO	ROULEMENT
27 REC93101-30M17	93101-30M17	RETÉN DE ACEITE	OIL SEAL	PARAOLIO	JOINT SPI
28 REC6G5-45383-01	6G5-45383-01	ARANDELA	WASHER	RONDELLA	RONDELLE
29 REC6G5-45384-00	6G5-45384-00	TUERCA	NUT	DADO	ÉCROU
30 REC6E5-45987-00	63P-45987-00	ESPACIADOR	SPACER	DISTANZIALE	ENTRETOISE
31 REC688-45997-00	688-45997-01	ESPACIADOR	SPACER	DISTANZIALE	ENTRETOISE
32 REC92990-18200	92990-18200	ARANDELA	WASHER	RONDELLA	RONDELLE
33 REC90171-18M04	90171-18M04	TUERCA	LOCK NUT	DADO	ÉCROU
34 REC91490-40030	91490-40030	PASADOR	PIN	SPINOTTO	CLAVETTE
		<b>CONTRA ROTACIÓN</b>	<b>COUNTER ROTATION</b>	<b>CONTRO ROTANTE</b>	<b>CONTRE</b>
35 REC6E5-45634-01	6E5-45634-02	DESIZADOR CAMBIO	SLIDE SHIFT	SPINOTTO SCORREVOLE	PIN REGLABLE
36 REC93332-00048	93332-00048	COJINETE	BEARING	CUSCINETTO	ROULEMENT

4T F150A/T/B/D (FL) • F175A/C • F200F/G  
STROKES

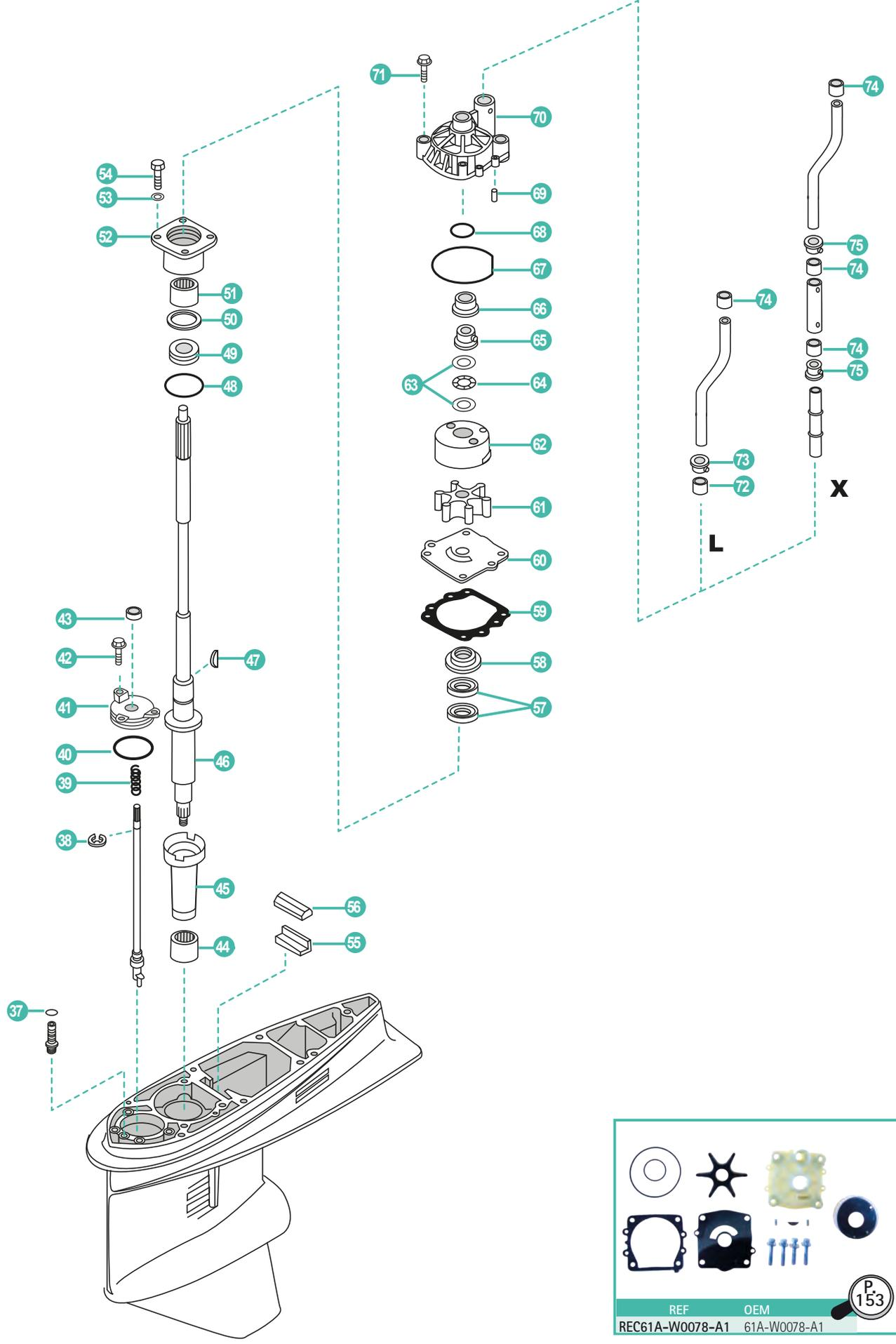

REF	OEM
REC61A-W0078-A1	61A-W0078-A1

P. 153

	REF	OEM				
37	REC93210-07540	93210-07003	TÓRICA	O-RING	O-RING	JOINT TORIQUE
38	REC99001-08600-00	99001-08600	CLIP	CLIP	CLIP	CLIP
39	REC90501-11M10-00	90501-11M10	RESORTE DE COMPRESIÓN	SPRING	MOLLA	RESSORT
40	REC93210-58677	93210-58144	TÓRICA	O-RING	O-RING	JOINT TORQUE
41	REC6E5-45321-00	6E5-45321-00	TAPA CAMBIO	PLATE	COPERCHIO CAMBIO	COUVERCLE
42	REC90119-06M10	90119-06M10	TORNILLO CON ARANDELA	SCREW WITH WASHER	VITE CON RONDELLA	VIS AVEC RONDELLE
43	REC93106-09014	93106-09014	RETÉN DE ACEITE	OIL SEAL	PARAOILIO	JOINT SPI
44	REC93311-928U5	93311-928U5	COJINETE	BEARING	CUSCINETTO	ROULEMENT
45	REC6E5-45536-00	6E5-45536-01	CAMISA EJE DE MANDO	SLEEVE	CAMICIA	BAGUE
46	REC63P-45501-00	63P-45501-00	EJE TRASMISION 20" (L)	DRIVE SHAFT 20" (L)	ALBERO DI TRASMISSIONE 20" (L)	ARBRE TRASMISION 20" (L)
	REC63P-45501-10	63P-45501-10	EJE TRASMISION 25" (X)	DRIVE SHAFT 25" (X)	ALBERO DI TRASMISSIONE 25" (X)	ARBRE TRASMISION 25" (X)
47	REC90280-04M05	90280-04M05	CUÑA	KEY WOODRUFF	CHIAVETTA	CLAVETTE
48	REC93210-54534	93210-55M14	TÓRICA	O-RING	O-RING	JOINT TORIQUE
49	REC93341-930V2	93341-930V2	COJINETE	BEARING	CUSCINETTO	ROULEMENT
50	REC6E5-45587-01	6E5-45587-01	KIT GRUESOS 0.10 - 0.50 mm	SHIM SET 0.10 - 0.50 mm	KIT SPESSORI 0.10 - 0.50 mm	KIT CALES 0.10- 0.50 mm
51	REC93317-330U2	93317-330U2	COJINETE	BEARING	CUSCINETTO	ROULEMENT
52	REC6E5-45331-00-94	6E5-45331-00-95	DIÁBOLO	GEAR HOUSING	DIABOLO	DIABOLO
53	PAGB/T97.1-8	92995-08600	ARANDELA	WASHER	RONDELLA	RONDELLE
54	PAGB/T5783-M8X25	97095-08025	PERNO	BOLT	BULLONE	BOULON
55	REC663-45376-00	663-45376-00-94	GUÍA SELLO DE GOMA	GUIDE RUB. SEAL	GUIDA PARAOLIO	GUIDE
56	REC688-45375-00	688-45375-00	RETEN DAMPER	DAMPER WASHER	PARAOILIO DAMPER	JOINT SILENT BLOC
57	REC93101-28M16	93101-28M16	RETÉN DE ACEITE	OIL SEAL	PARAOILIO	JOINT SPI
58	REC6E5-45344-00	6E5-45344-00	CUBIERTA SELLO DE ACEITE	RETAINER	COPERCHIO PARAOLIO	RETENUE
59	REC6E5-44315-A0	6E5-44315-A0	JUNTA	GASKET	GUARNIZIONE	JOINT
60	REC6G5-44323-00	6G5-44323-00	PLACA EXTERIOR DEL CARTUCHO	OUTER PLATE	COPERCHIO POMPA	PLAQUE DE POMPE À EAU
61	REC6E5-44352-01	6E5-44352-01	TURBINA	IMPELLER	GIRANTE	TURBINE
62	REC61A-44322-02	61A-44322-02	ACOPLE INOX	INSERT CARTRIDGE	ACCOPIAMENTO INOX	INSERT DE POMPE À EAU
63	REC90201-22M01	90201-22M01	ARANDELA	WASHER	RONDELLA	RONDELLE
64	REC90206-22M19	90206-22M19	ARANDELA ONDULADA	WAVE WASHER	RONDELLA ONDULATA	RONDELLE
65	REC61A-45538-00	61A-45538-00	ESPACIADOR	SPACER	SPESSORE	ENTRETOISE
66	REC61A-45527-00	61A-45527-00	CASQUILLO CUERPO BOMBA	COLLAR	BOCCOLA CORPO POMPA	BAGUE POMPE À EAU
67	REC93210-86M38	93210-86M38	TÓRICA	O-RING	O-RING	JOINT TORIQUE
68	REC93210-37160	93210-37160	TÓRICA	O-RING	O-RING	JOINT TORIQUE
69	REC93606-12019	93606-12019	PASADOR	PIN	SPINOTTO	PIN
70	REC61A-44311-00	61A-44311-01	CUERPO BOMBA AGUA	HOUSING, WATER PUMP	CORPO POMPA	CORPS DE POMPE À EAU
71	REC90119-08M14	90119-08M14	TORNILLO CON ARANDELA	SCREW WITH WASHER	VITE CON RONDELLA	VIS AVEC RONDELLE
72	REC6E5-44365-00	6E5-44365-00	GOMA DEL SELLO DE AGUA	DAMPER WATER TUBE	GUARNIZIONE	BAGUE DE TUBE D'EAU
73	REC6E5-44312-00	6E5-44312-00	CUBIERTA CAJA DE BOMBA DE AGUA (L)	WATER PUMP COVER (L)	COPERCHIO POMPA ACQUA (L)	GUIDE DE TBE D'EAU (L)
74	REC6E5-44365-00	6E5-44365-00	GOMA TUBO AGUA	DAMPER WATER TUBE	GUARNIZIONE	BAGUE DE TUBE D'EAU
75	REC6E5-44312-00	6E5-44312-00	CUBIERTA CAJA DE BOMBA DE AGUA (X)	WATER PUMP COVER (X)	COPERCHIO POMPA ACQUA (X)	GUIDE DE TUBE D'EAU (X)



REF  
REC80W90U3  
REC80W90U6  
RECGREU1  
RECGREU12

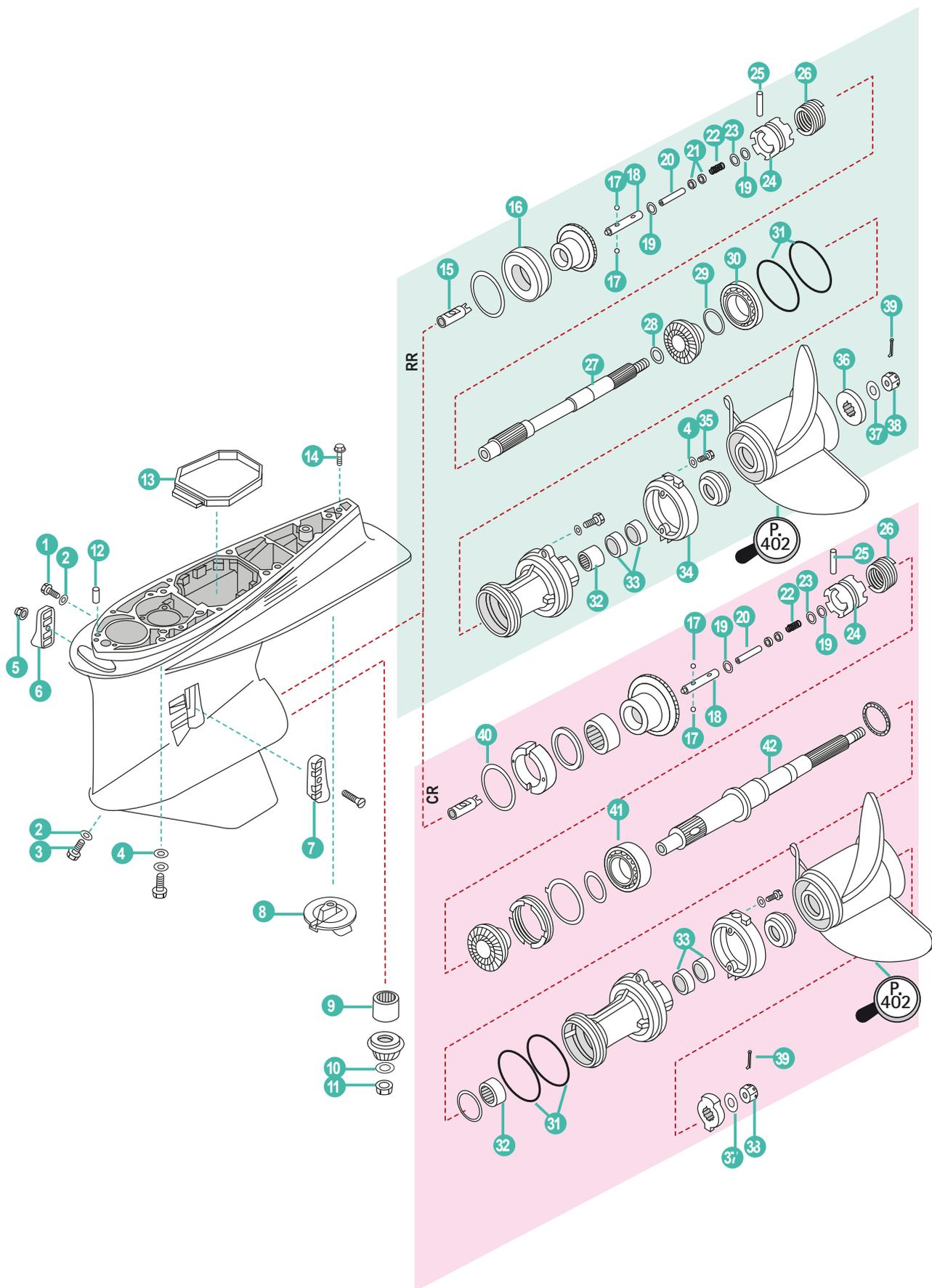

	REF	OEM				
	REC421-B25F	69J-45300-22-8D	CONJUNTO INFERIOR RR (X)	COMPLETE GEARCASE V6 (X)	PIEDE COMPLETO V6 (X)	EMBASE COMPLETE (X)
1	REC90340-08002	90304-08002	TORNILLO DRENAJE	BOLT, DISCHARGING OIL	VITE DRENAGGIO	BOUCHON DE VIDANGE
2	REC90430-08020	90430-08020	JUNTA	GASKET	GUARNIZIONE	JOINT
3	REC688-45341-00	688-45341-10	TORNILLO DRENAJE	BOLT, DISCHARGING OIL	VITE DRENAGGIO	BOUCHON DE VIDANGE
4	PAGB/T97.1-8	92995-10600	ARANDELA	WASHER	RONDELLA	RONDELLE
5	PAGB/T6182-M5	90185-05002	TUERCA	LOCK NUT	DADO	ÉCROU
6	REC61A-45215-10	61A-45215-11	REJILLA TOMA AGUA ESTRIBOR	WATER SCREEN STARBOARD	GRIGLIA PRESA ACQUA TRIBORDO	GRILLE D'ENTREE D'EAU TRIBORD
7	REC61A-45214-10	61A-45214-11	REJILLA TOMA AGUA BABOR	WATER SCREEN PORT	GRIGLIA PRESA ACQUA BABORDO	GRILLE D'ENTREE D'EAU BABORD
8	CM61A-45371-00A	61A-45371-00	ÁNODO	ANODE	ANODO	ANODE
9	REC93311-83280	93311-83280	COJINETE	BEARING	CUSCINETTO	ROULEMENT
10	REC90201-16M00	90201-16M00	ARANDELA	WASHER	RONDELLA	RONDELLE
11	REC90170-16M19	90170-16M19	TUERCA	LOCK NUT	DADO	ÉCROU
12	REC93608-12M05	93608-12M05	PASADOR	PIN	SPINOTTO	PIN
13	REC69J-45375-00	69J-45375-00	GOMA ESCAPE COLA	EXHAUST DAMPER	GOMMA SCARICO	JOINT D'ÉCHAPPEMENT
14	PAT85-00000012	90105-10M00	TORNILLO	SCREW	VITE	VIS
15	REC61A-45641-02	61A-45641-02	CAMBIO	SHIFTER	CAMBIO	SHIFTER
16	REC93332-000W1	93332-000W1	COJINETE	BEARING	CUSCINETTO	ROULEMENT
17	REC93501-04011	93501-04011	ESFERA	BALL	SFERA	BILLE
18	REC61A-45634-01	61A-45634-01	PASADOR DESPLAZABLE	SLIDE SHIFT	SPINOTTO SCORREVOLE	PIN REGLABLE
19	REC90183-02M03	90183-02M03	TUERCA DE RESORTE	SPRING NUT	DADO MOLLA	RONDELLE FREIN
20	REC6H1-45668-00	6H1-45668-00	EJE	FREE SHAFT	ASSE	ARBRE
21	REC61A-45635-00	61A-45635-00	ÉMBOLO DE CAMBIO	SHIFT PLUNGER	GOMMINI	SHIFT
22	REC90501-10M77	90501-10M77	RESORTE DE COMPRESIÓN	SPRING	MOLLA	RESSORT
23	REC90201-02M00	90201-02M00	ARANDELA PLANA	WASHER	RONDELLA	RONDELLE
24	REC69J-45631-00	69J-45631-00	EMBRAGUE DE GARRA	CLUTH	SELETTORE	CRABOT
25	REC61A-45632-00	61A-45632-00	PASADOR	PIN	SPINOTTO	LEVIER
26	REC61A-45633-00	61A-45633-00	ANILLO DEL PASADOR	ANNULAR SPRING, CLUTCH	ANELLO	RESSORT
27	REC69J-45611-00	69J-45611-00	EJE	SHAFT	ASSE	ARBRE D'HELICE
28	REC90201-31M00	90201-31M00	ARANDELA PLANA	WASHER	RONDELLA	RONDELLE
29	REC61A-45577-00/60-0	61A-45577-00	KIT GRUESOS (0.10-0.50 mm)	KIT SHIM (0.10-0.50 mm)	KIT SPESSORE (0.10-0.50 mm)	KIT CALES (0.10 - 0.50 mm)
30	REC93306-210U0	93306-210U0	COJINETE	BEARING	CUSCINETTO	ROULEMENT
31	REC93211-04384	93211-04384	TÓRICA	O-RING	O-RING	JOINT TORIQUE
32	REC93315-43061	93315-43061	COJINETE	BEARING	CUSCINETTO	ROULEMENT
33	REC93101-30M17	93101-30M17	RETÉN DE ACEITE	OIL SEAL	PARAOLIO	ROULEMENT
34	REC69J-45361-00-8D	69J-45361-00-8D	FUNDA INFERIOR	CAO LOWER CASING	COVER INFERIORE	COUVERCLE INFERIEUR
35	PAF4-04000001	97095-08020	PERNO	STUD	BULLONE	BOULON
36	REC688-45997-00	688-45997-01	ESPACIADOR AP	DISTANCE WASHER	DISTANZIALE	BRIDE
37	REC92990-18200	92990-18200	ARANDELA PLANA	WASHER	RONDELLA	RONDELLE
38	REC90171-18M04	90171-18M04	TUERCA	LOCK NUT	DADO	ÉCROU
39	REC91490-40030	91490-40030	PASADOR	PIN	SPINOTTO	CLAVETTE

			CONTRA ROTACIÓN	COUNTER ROTATION	CONTRO ROTANTE	CONTRE ROTATION
40	REC61A-45567-00/60-0	61A-45567-00	KIT GRUESOS (0.10-0.50 mm)	KIT SHIM (0.10-0.50 mm)	KIT SPESSORE (0.10-0.50 mm)	KIT CALES (0.10 - 0.50 mm)
41	REC93332-00048	93332-00048	COJINETE	BEARING	CUSCINETTO	ROULEMENT
42	REC69K-45611-00	69K-45611-00	EJE	SHAFT	ASSE	ARBRE D'HELICE

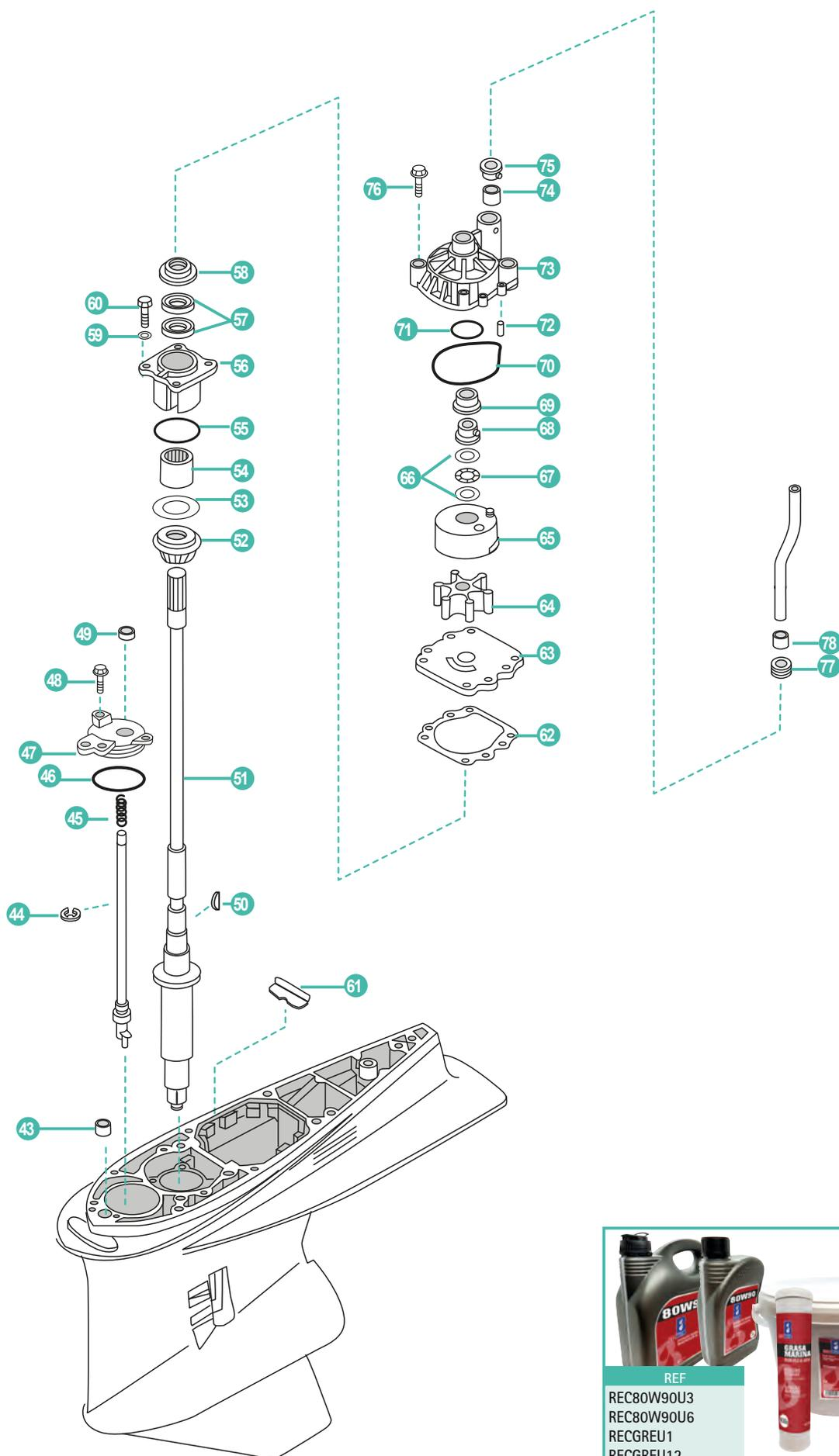

	REF	OEM				
43	REC663-44366-00	663-44366-00	RETEN TUBO AGUA	DAMPER, WATER SEAL	GHIERA	JOINT DE TUBE D'EAU
44	REC99001-08600-00	99001-08600	CLIP	CLIP	CLIP	CLIP
45	REC90501-11M10-00	90501-11M10	RESORTE DE COMPRESIÓN	SPRING	MOLLA	RESSORT
46	REC93210-65752-00	93210-64488	TÓRICA	O-RING	O-RING	JOINT TORIQUE
47	REC61A-45321-01	61A-45321-01	TAPA CAMBIO	SHIFT SHAFT COVER	SHIFT SHAFT COVER	COUVERCLE ARBRE DE TRANSMISSION
48	REC90119-06M10	90119-06M10	TORNILLO CON ARANDELA	SCREW WITH WASHER	VITE CON RONDELLA	VIS AVEC RONDELLE
49	REC93106-09014	93106-09014	RETÉN DE ACEITE	OIL SEAL	PARAOLIO	ROULEMENT
50	REC90280-04M05	90280-04M05	CUÑA	KEY WOODRUFF	CHIAVETTA	CLAVETTE
51	REC63P-45501-00	63P-45501-00	EJE TRASMISION 20"	DRIVE SHAFT 20"	ALBERO DI TRASMISSIONE 20"	ARBRE TRASMISION 20"
	REC63P-45501-10	63P-45501-10	EJE TRASMISION 25"	DRIVE SHAFT 25"	ALBERO DI TRASMISSIONE 25"	ARBRE TRASMISION 25"
52	REC93341-93020	93341-93020	COJINETE	BEARING	CUSCINETTO	CLAVETTE
53	REC61A-45587-00/60-0	61A-45587-00	KIT GRUESOS (0.10-0.50 mm)	KIT SHIM (0.10-0.50 mm)	KIT SPESSORE (0.10-0.50 mm)	KIT CALES (0.10 - 0.50 mm)
54	REC93317-330U2	93317-330U2	COJINETE	BEARING	CUSCINETTO	ROULEMENT
55	REC93210-54534	93210-54534	TÓRICA	O-RING	O-RING	JOINT TORIQUE
56	REC61A-45331-00-94	61A-45331-00-94	DIÁBOLO	GEAR HOUSING	DIABOLO	DIABOLO
57	REC93101-28M16	93101-28M16	RETÉN DE ACEITE	OIL SEAL	PARAOLIO	JOINT SPI
58	REC6E5-45344-00	6E5-45344-00	CUBIERTA SELLO DE ACEITE	RETAINER	COPERCHIO PARAOLIO	RETENUE
59	PAGB/T97.1-8	92995-08600	ARANDELA	WASHER	RONDELLA	RONDELLE
60	PAGB/T5783-M8X25	97095-08025	PERNO	STUD	BULLONE	BOULON
61	REC61A-45376-00-94	61A-45376-00	GUÍA SELLO DE GOMA	GUIDE	GUIDE	GUIDE
62	REC6E5-44315-A0	6E5-44315-A0	JUNTA	GASKET	GUARNIZIONE	JOINT
63	REC6G5-44323-00	6G5-44323-00	TAPA BOMBA	OUTER PLATE	COPERCHIO POMPA	PLAQUE DE POMPE À EAU
64	REC6E5-44352-01	6E5-44352-01	TURBINA	IMPELLER	GIRANTE	TURBINE
65	REC61A-44322-02	61A-44322-02	TAPA, BOMBA AGUA	COVER, INNER WATER PUMP	COPERCHIO, POMPE ACQUA	INSERT DE POMPE À EAU
66	REC90201-22M01	90201-22M01	ARANDELA	WASHER	RONDELLA	RONDELLE
67	REC90206-22M19	90206-22M19	ARANDELA ONDULADA	WAVE WASHER	RONDELLA ONDULATA	RONDELLE
68	REC61A-45538-00	61A-45538-00	ESPACIADOR	SPACER	SPESSORE	ENTRETOISE
69	REC61A-45527-00	61A-45527-00	CASQUILLO CUERPO BOMBA	COLLAR	BOCCOLA CORPO POMPA	BAGUE POMPE À EAU
70	REC93210-86M38	93210-86M38	TÓRICA	O-RING	O-RING	JOINT TORIQUE
71	REC93210-37160	93210-37160	TÓRICA	O-RING	O-RING	JOINT TORIQUE
72	REC93606-12019	93606-12019	PASADOR	PIN	SPINOTTO	PIN
73	REC61A-44311-00	61A-44311-01	CUERPO BOMBA AGUA	HOUSING, WATER PUMP	CORPO POMPA	CORPS DE POMPE À EAU
74	REC6E5-44365-00	6E5-44365-00	GOMA DEL SELLO DE AGUA	DAMPER WATER TUBE	GUARNIZIONE	BAGUE DE TUBE D'EAU
75	REC6E5-44312-00	6E5-44312-00	CUBIERTA CAJA DE BOMBA DE AGUA	WATER PUMP COVER	COPERCHIO POMPA ACQUA	BAGUE DE POMPE À EAU
76	REC90119-08M14	90119-08M14	TORNILLO CON ARANDELA	SCREW WITH WASHER	VITE CON RONDELLA	VIS AVEC RONDELLE
77	REC6E5-44366-00	6E5-44366-00	GOMA DEL SELLO DE AGUA	DAMPER WATER TUBE	GUARNIZIONE	BAGUE DE TUBE D'EAU
78	REC6E5-44365-00	6E5-44365-00	GOMA TUBO AGUA	DAMPER WATER TUBE	GOMMA TUBO ACQUA	BAGUE DE TUBE D'EAU

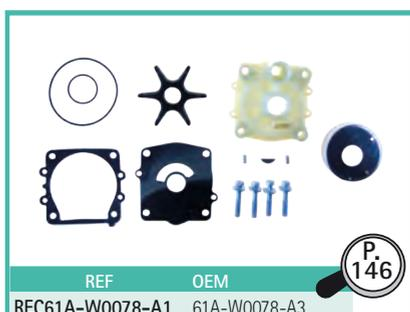

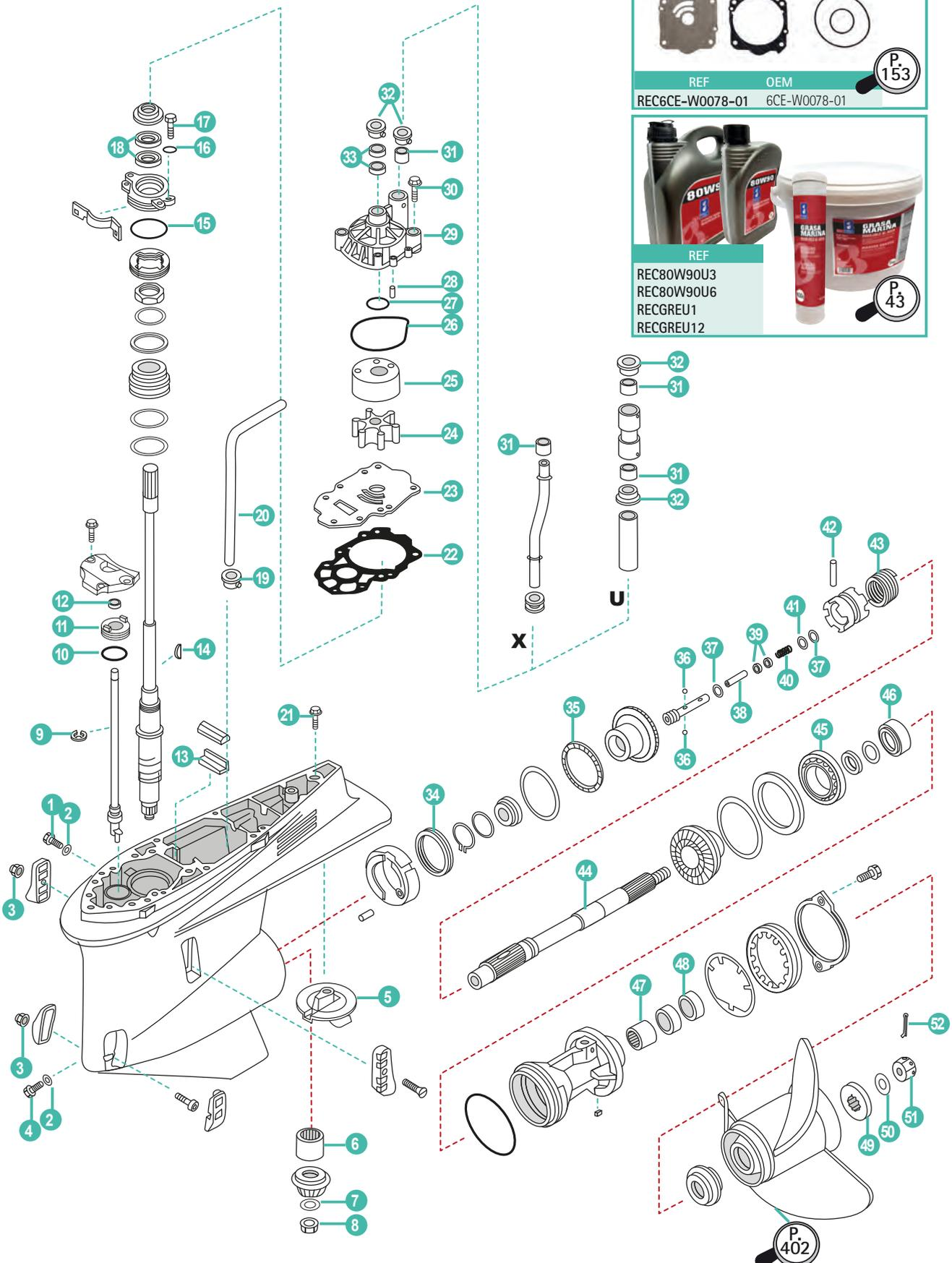

REF	OEM
REC6CE-W0078-01	6CE-W0078-01

P. 153

REF
REC80W90U3
REC80W90U6
RECGREU1
RECGREU12

P. 43



	REF	OEM				
1	REC90340-08002	90304-08002	TORNILLO DRENAJE	BOLT, DISCHARGING OIL	VITE DRENAGGIO	BOUCHON DE VIDANGE
2	REC90430-08020	90430-08020	JUNTA	GASKET	GUARNIZIONE	JOINT
3	PAGB/T6182-M5	90185-05002	TUERCA	LOCK NUT	DADO	ÉCROU
4	REC688-45341-00	688-45341-10	TORNILLO DRENAJE	BOLT, DISCHARGING OIL	VITE DRENAGGIO	BOUCHON DE VIDANGE
5	CM61A-45371-00A	61A-45371-00	ÁNODO	ANODE	ANODO	ANODE
6	REC93311-83280	93311-83280	COJINETE	BEARING	CUSCINETTO	ROULEMENT
7	REC90201-16M00	90201-16M00	ARANDELA	WASHER	RONDELLA	RONDELLE
8	REC90170-16M19	90170-16M19	TUERCA	LOCK NUT	DADO	ÉCROU
9	REC99001-08600-00	99001-08600	ARANDELA	WASHER	RONDELLA	RONDELLE
10	PAJASOF404-19-033	93210-33M49	TÓRICA	O-RING	O-RING	JOINT TORIQUE
11	REC65N-45321-00	65N-45321-00	TAPA SELECTOR	PLATE	COPERCHIO SELETTORE	COUVERCLE DU SELECTEUR
12	REC93106-09014	93106-09014	RETÉN DE ACEITE	OIL SEAL	PARAOLIO	JOINT SPI
13	REC663-45376-00	663-45376-00	GUÍA DE SELLO DE GOMA	GUIDE RUB. SEAL	GUIDA PARAOLIO	GUIDE
14	REC90280-04002	90280-04002	CUÑA	KEY WOODRUFF	CHIAVETTA	CLAVETTE
15	REC93210-65752-00	93210-64488	TÓRICA	O-RING	O-RING	JOINT TORIQUE
16	PAGB/T97.1-8	92995-08600	ARANDELA	WASHER	RONDELLA	RONDELLE
17	PAF4-04000001	97095-08020	PERNO	STUD	BULOONE	BOULON
18	REC93101-28M16	93101-28M16	RETÉN DE ACEITE	OIL SEAL	PARAOLIO	JOINT SPI
19	REC6D0-44367-00	6D0-44367-00	GOMA DEL SELLO DE AGUA	DAMPER, WATER SEAL	GOMMA TUBO ACQUA	MANCHON TUBE D'EAU
20	REC6D0-44362-01	6D0-44362-01	TUBO DE AGUA	WATER TUBE	TUBO ACQUA	DURITE D'EAU
21	PAT85-00000012	90105-10M00	TORNILLO	BOLT	VITE	VIS
22	REC6CE-44315-00	6CE-44315-00	JUNTA	GASKET	GUARNIZIONE	JOINT
23	REC6CE-44323-01	6CE-44323-01	TAPA BOMBA	OUTER PLATE, CARTRIDGE	COPERCHIO POMPA ACQUA	PLAQUE DE POMPE À EAU
24	REC6CE-44352-00	6CE-44352-01	TURBINA	IMPELLER	GIRANTE	TURBINE
25	REC6AW-44322-00	6AW-44322-00	TAPA, BOMBA AGUA	COVER, INNER WATER PUMP	COPERCHIO, POMPE ACQUA	INSERT DE POMPE À EAU
26	REC93210-94003	93210-94003	TÓRICA	O-RING	O-RING	JOINT TORIQUE
27	REC93210-37160	93210-37160	TÓRICA	O-RING	O-RING	JOINT TORIQUE
28	REC93606-12019	93606-12019	PASADOR	PIN	SPINOTTO	PIN
29	REC6CE-44311-01	6CE-44311-01	CUERPO BOMBA AGUA	HOUSING, WATER PUMP	CORPO POMPA	CORPS DE POMPE À EAU
30	REC90119-08M14	90119-08M14	TORNILLO CON ARANDELA	SCREW WITH WASHER	VITE CON RONDELLA	VIS AVEC RONDELLE
31	REC6AW-44365-00	6AW-44365-00	GOMA DEL SELLO DE AGUA	DAMPER, WATER SEAL	ANELLO TUBO ACQUA	RETENUE TUBE D'EAU
32	REC6AW-44312-00	6AW-44312-00	CUBIERTA CAJA DE BOMBA DE AGUA	WATER PUMP COVER	COPERCHIO POMPA ACQUA	BAGUE DE POMPE À EAU
33	REC93104-22M07	93104-22M07	RETÉN DE ACEITE	OIL SEAL	PARAOLIO	ROULEMENT
34	REC93311-85894	93311-85894	COJINETE	BEARING	CUSCINETTO	ROULEMENT
35	REC93340-67011	93340-67011	COJINETE	BEARING	CUSCINETTO	ROULEMENT
36	REC93501-04011	93501-04011	ESFERA	BALLE	SFERA	BILLE
37	REC90183-02M03	90183-02M03	TUERCA DE RESORTE	SPRING NUT	DADO MOLLA	RONDELLE FREIN
38	REC6H1-45668-00	6H1-45668-00	EJE	SHAFT	ASSE	ARBRE
39	REC61A-45635-00	61A-45635-00	ÉMBOLO DE CAMBIO	SHIFT PLUNGER	GUARNIZIONE	SHIFT
40	REC90501-10M77	90501-10M77	RESORTE DE COMPRESIÓN	SPRING	MOLLA	RESSORT
41	REC90201-02M00	90201-02M00	ARANDELA PLANA	WASHER	RONDELLA	RONDELLE
42	REC90250-08M07	90250-08M07	PASADOR	PIN	SPINOTTO	PIN
43	REC6E5-45633-01	6E5-45633-01	ANILLO DEL PASADOR	ANULAR SPRING, CLUTCH	ANELLO	RESSORT
44	REC6CB-45611-00	6CB-45611-00	EJE	SHAFT	ASSE	ARBRE D'HELICE
45	REC93306-209U0	93306-209U0	COJINETE	BEARING	CUSCINETTO	ROULEMENT
46	REC93332-000A5	93332-000A5	COJINETE	BEARING	CUSCINETTO	ROULEMENT
47	REC93315-43061	93315-43061	COJINETE	BEARING	CUSCINETTO	ROULEMENT
48	REC93101-30002	93101-30002	RETÉN DE ACEITE	OIL SEAL	PARAOLIO	JOINT SPI
49	REC688-45997-00	688-45997-01	ESPACIADOR	SPACER	SPESSORE	ENTRETOISE
50	REC92990-18200	92990-18200	ARANDELA PLANA	WASHER	RONDELLA	RONDELLE
51	REC90171-18M04	90171-18M04	TUERCA	LOCK NUT	DADO	ÉCROU
52	REC91490-40030	91490-40030	PASADOR	PIN	SPINOTTO	CLAVETTE

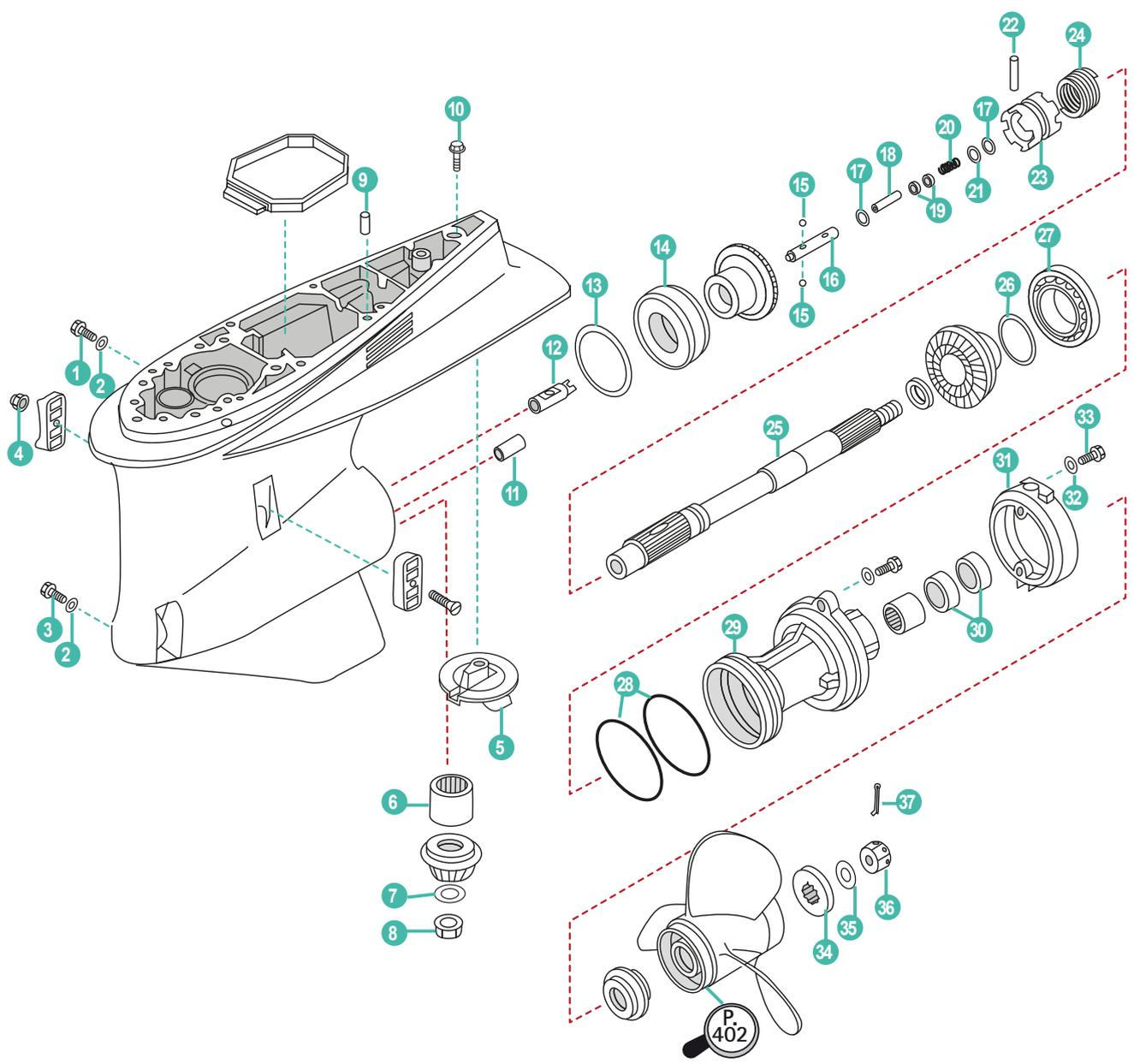

REF	OEM
REC6P2-W0078-00	61P2-W0078-00

P. 153

REF
REC80W90U3
REC80W90U6
RECGREU1
RECGREU12

P. 43

	REF	OEM				
1	REC90340-08002	90304-08002	TORNILLO DRENAJE	BOLT, DISCHARGING OIL	VITE DRENAGGIO	VIS DE VIDANGE
2	REC90430-08020	90430-08020	JUNTA	GASKET	GUARNIZIONE	JOINT
3	REC688-45341-00	688-45341-10	TORNILLO DRENAJE	BOLT, DISCHARGING OIL	VITE DRENAGGIO	VIS DE VIDANGE
4	PAGB/T6182-M5	90185-05002	TUERCA	LOCK NUT	DADO	ÉCROU
5	CM61A-45371-00A	61A-45371-00	ÁNODO	ANODE	ANODO	ANODE
6	REC93311-83280	93311-83280	COJINETE	BEARING	CUSCINETTO	PALIER
7	REC90201-16M00	90201-16M00	ARANDELA	WASHER	RONDELLA	RONDELLE
8	REC90170-16M19	90170-16M19	TUERCA	LOCK NUT	DADO	ÉCROU
9	REC93608-12M05	93608-12M05	PASADOR	PIN	SPINOTTO	LEVIER
10	PAT85-00000012	90105-10M00	TORNILLO	SCREW	VITE	VIS
11	REC99590-10114	99590-10114	PASADOR	PIN	SPINOTTO	LEVIER
12	REC61A-45641-02	61A-45641-02	CAMBIO	SHIFTER	CAMBIO	SHIFTER
13	REC61A-45567-00/60-0	61A-45567-00	KIT GRUESOS (0.10-0.50 mm)	KIT SHIM (0.10-0.50 mm)	KIT SPESSORE (0.10-0.50 mm)	KIT CALES (0.10 - 0.50 mm)
14	REC93332-000W1	93332-000W1	COJINETE	BEARING	CUSCINETTO	ROULEMENT
15	REC93501-04011	93501-04011	ESFERA	BALL	SFERA	BILLE
16	REC61A-45634-01	61A-45634-01	DESLIZADOR CAMBIO	SHIFT SLIDE	SPINOTTO SCORREVOLE	SHIFT
17	REC90183-02M03	90183-02M03	TUERCA DE RESORTE	SPRING NUT	DADO MOLLA	RONDELLE FREIN
18	REC6H1-45668-00	6H1-45668-00	EJE	SHAFT	ASSE	ARBRE
19	REC61A-45635-00	61A-45635-00	DESLIZADOR CAMBIO	SHIFT SLIDE	SPINOTTO	SHIFT
20	REC90501-10M77	90501-10M77	RESORTE DE COMPRESIÓN	SPRING	MOLLA	RESSORT
21	REC90201-02M00	90201-02M00	ARANDELA PLANA	WASHER	RONDELLA	RONDELLE
22	REC61A-45632-00	61A-45632-00	PASADOR	PIN	SPINOTTO	PIN
23	REC69J-45631-00	69J-45631-00	EMBRAGUE DE GARRA	CLUTH	SELETTORE	CRABOT
24	REC61A-45633-00	61A-45633-00	ANILLO DEL PASADOR	ANNULAR SPRING, CLUTCH	ANELLO	RESSORT
25	REC69J-45611-00	69J-45611-00	EJE	SHAFT	ASSE	ARBRE
	REC69K-45611-00	69K-45611-00	EJE CONTRARROTACIÓN	CR SHAFT	ASSE CR	ARBRE D'HELICE CR
26	REC61A-45577-00/60-0	61A-45577-00	KIT GRUESOS (0.10-0.50 mm)	KIT SHIM (0.10-0.50 mm)	KIT SPESSORE (0.10-0.50 mm)	KIT CALES (0.10 -0.50 mm)
27	REC93306-210U0	93306-210U0	COJINETE	BEARING	CUSCINETTO	ROULEMENT
28	REC93211-04384	93211-04384	TÓRICA	O-RING	O-RING	JOINT TORIQUE
29	REC6D0-45332-00-CA	6D0-45332-00-CA	DIÁBOLO	GEAR HOUSING	DIABOLO	DIABOLO
30	REC93101-30002	93101-300002	RETÉN DE ACEITE	OIL SEAL	PARAOLIO	JOINT SPI
31	REC6D0-45361-00-8D	6D0-45361-00-8D	FUNDA INFERIOR	CAO LOWER CASING	COVER INFERIORE	COUVERCLE INFERIEUR
32	PAF4-04000001	97095-08020	PERNO	BOLT	BULONE	BOULON
33	PAGB/T97.1-8	92995-08600	ARANDELA	WASHER	RONDELLA	RONDELLE
34	REC688-45997-00	688-45997-01	ESPACIADOR	SPACER	SPESSORE	CALES
35	REC92990-18200	92990-18200	ARANDELA PLANA	WASHER	RONDELLA	RONDELLE
36	REC90171-18M04	90171-18M04	TUERCA	LOCK NUT	DADO	ÉCROU
37	REC91490-40030	91490-40030	PASADOR	PIN	SPINOTTO	CLAVETTE

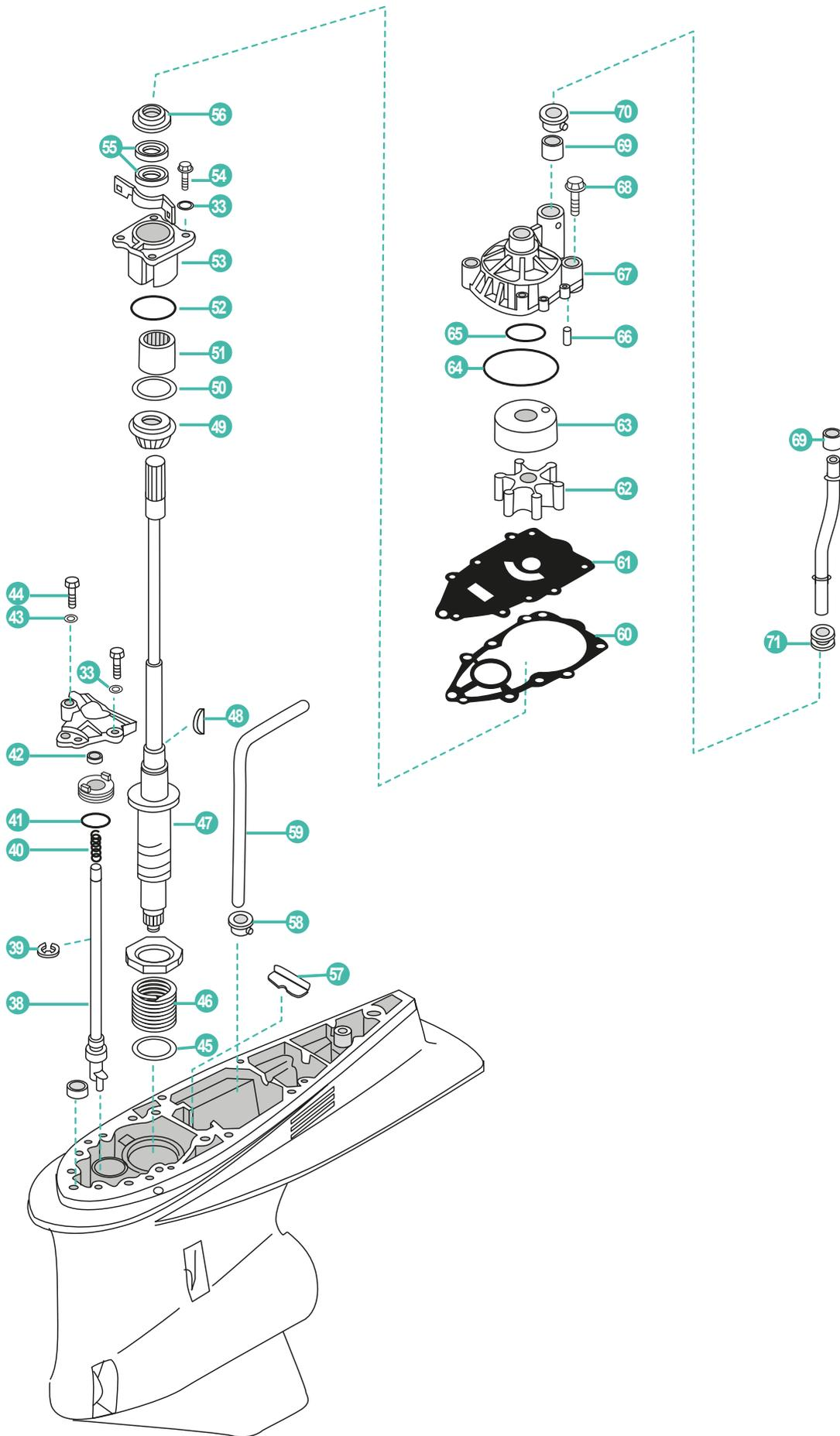

	REF	OEM				
38	REC6P2-44150-00	6P2-44150-00	VARILLA SELECTOR	SHIFT CAM ASSY	ASTA SELETTORE	TIGE DE SELECTEUR
39	REC99001-08600-00	99001-08600	CLIP	CLIP	RONDELLA	CLIP
40	REC90501-11M10-00	90501-11M10	RESORTE DE COMPRESIÓN	SPRING	MOLLA	RESSORT
41	PAJASOF404-19-033	93210-33M49	TÓRICA	O-RING	O-RING	JOINT TORIQUE
42	REC93106-09014	93106-09014	RETÉN DE ACEITE	OIL SEAL	PARAOLIO	ROULEMENT
43	PAGB/T97.1-6	92995-06600	ARANDELA	WASHER	RONDELLA	RONDELLE
44	PAGB/T5783-M6X16	97095-06016	PERNO	BOLT	BULLONE	BOULON
45	REC90201-42014	90201-42014	ARANDELA PLANA	WASHER	RONDELLA	RONDELLE
46	REC90501-450A2	90501-450A2	RESORTE	SPRING	MOLLA	RESSORT
47	REC6P2-45501-11	6P2-45501-10	EJE TRANSMISION U (30.3")	DRIVE SHSFT U (30.3")	ASSE TRASMISSIONE U (30.3")	ARBRE DE TRANSMISSION U (30.3")
	REC6P2-45501-01	6P2-45501-00	EJE TRANSMISION X (25.3")	DRIVE SHSFT X (25.3")	ASSE TRASMISSIONE X (25.3")	ARBRE DE TRANSMISSION X (25.3")
48	REC90280-04M05	90280-04M05	CUÑA	KEY WOODRUFF	CHIAVETTA	CLAVETTE
49	REC93341-93020	93341-930U9	COJINETE	BEARING	CUSCINETTO	ROULEMENT
50	REC61A-45587-00/60-0	61A-45587-00	KIT GRUESOS (0.10-0.50 mm)	KIT SHIM (0.10-0.50 mm)	KIT SPESSORE (0.10-0.50 mm)	KIT CALES (0.10 - 0.50 mm)
51	REC93317-330U2	93317-330U2	COJINETE	BEARING	CUSCINETTO	ROULEMENT
52	REC93210-54534	93210-54534	TÓRICA	O-RING	O-RING	JOINT TORIQUE
53	REC6P2-45331-00-9S	6P2-45331-00-9S	CAJA DE COJINETE	HOUSING, BEARING	SCATOLA CUSCINETTO	PALIER DE ROULEMENT
54	PAGB/T5783-M8X25	97095-08025	PERNO	BOLT	BULLONE	BOULON
55	REC93101-28M16	93101-28M16	RETÉN DE ACEITE	OIL SEAL	PARAOLIO	JOINT SPI
56	REC6E5-45344-00	6E5-45344-00	TAPA RETEN	RETAINER	COPERCHIO PARAOLIO	RETENUE
57	REC61A-45376-00-94	61A-45376-00	GUÍA SELLO DE GOMA	GUIDE	GUIDA	GUIDE
58	REC6D0-44367-00	6D0-44367-00	GOMA TUBO AGUA	DAMPER, WATER SEAL	GOMMA TUBO ACQUA	MANCHON TUBE D'EAU
59	REC6D0-44362-01	6D0-44362-01	TUBO DE AGUA	WATER TUBE	TUBO ACQUA	TUBE D'EAU
60	REC60X-44315-A0	60X-44315-A0	JUNTA	GASKET	GUARNIZIONE	JOINT
61	REC6P2-44323-00	6P2-44323-00	PLACA EXTERIOR DEL CARTÚCHO	OUTER PLATE	PLACCA ESTERNA	PLAQUE DE POMPE À EAU
62	REC6E5-44352-01	6E5-44352-01	TURBINA	IMPELLER	GIRANTE	TURBINE
63	REC61A-44322-02	61A-44322-02	TAPA, BOMBA AGUA	COVER, INNER WATER PUMP	COPERCHIO, POMPE ACQUA	INSERT DE POMPE À EAU
64	REC93210-86M38	93210-86M38	TÓRICA	O-RING	O-RING	JOINT TORIQUE
65	REC93210-37160	93210-37160	TÓRICA	O-RING	O-RING	JOINT TORIQUE
66	REC93606-12019	93606-12019	PASADOR	PIN	SPINOTTO	PIN
67	REC61A-44311-00	61A-44311-01	CUERPO BOMBA AGUA	HOUSING, WATER PUMP	CORPO POMPA	CORPS DE POMPE À EAU
68	REC90119-08M14	90119-08M14	TORNILLO CON ARANDELA	SCREW WITH WASHER	VITE CON RONDELLA	VIS AVEC RONDELLE
69	REC6E5-44365-00	6E5-44365-00	GOMA DEL SELLO DE AGUA	DAMPER, WATER SEAL	ANELLO TUBO ACQUA	RETENUE TUBE D'EAU
70	REC6E5-44312-00	6E5-44312-00	CUBIERTA CAJA DE BOMBA DE AGUA	WATER PUMP COVER	COPERCHIO POMPA ACQUA	GUIDE DE POMPE À EAU
71	REC6E5-44366-00	6E5-44366-00	GOMA DEL SELLO DE AGUA	DAMPER, WATER SEAL	ANELLO TUBO ACQUA	RETENUE TUBE D'EAU
	REC422-B25F	6P2-45300-20-8D 6P2-45300-21-8D	CONJUNTO INFERIOR	COMPLETE GEARCASE	PIEDE COMPLETO	EMBASE COMPLETE
	REC429-B25F	6P3-45300-40-8D 6P3-45300-41-8D	CONJUNTO INFERIOR CONTRA ROTACIÓN	COMPLETE GEARCASE COUNTER ROTATION	PIEDE COMPLETO CONTRO ROTANTE	EMBASE COMPLETE CONTRE ROTATION

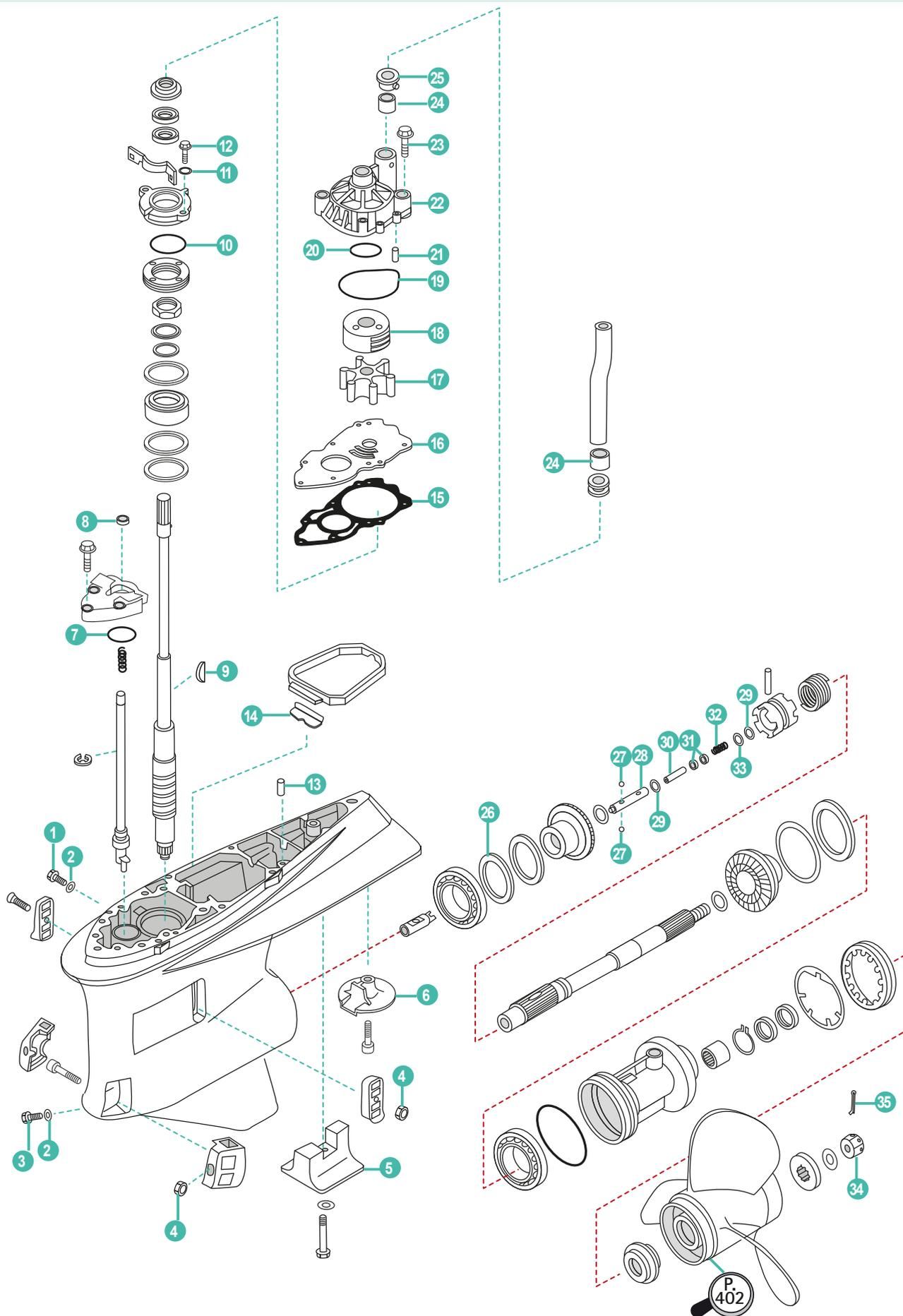

	REF	OEM				
1	REC90340-08002	90304-08002	TORNILLO DRENAJE	BOLT, DISCHARGING OIL	VITE DRENAGGIO	BOUCHON DE VIDANGE
2	REC90430-08020	90430-08020	JUNTA	GASKET	GUARNIZIONE	JOINT
3	REC688-45341-00	688-45341-10	TORNILLO DRENAJE	BOLT, DISCHARGING OIL	VITE DRENAGGIO	BOUCHON DE VIDANGE
4	PAGB/T6182-M5	90185-05002	TUERCA	LOCK NUT	DADO	ÉCROU
5	CM6AW-45373-00A	6AW-45373-00	ÁNODO	ANODE	ANODO	ANODE
6	CM6AW-45619-00A	6AW-45619-00	ÁNODO	ANODE	ANODO	ANODE
7	REC93210-48214	93210-48214	TÓRICA	O-RING	O-RING	JOINT TORIQUE
8	REC93101-12M70	93101-12M70	RETÉN DE ACEITE	OIL SEAL	PARAOILIO	JOINT SPI
9	REC6AW-44336-00	6AW-44336-00	CUÑA	KEY WOODRUFF	CHIAVETTA	CLAVETTE
10	REC93210-69MG6	93210-69MG6	TÓRICA	O-RING	O-RING	JOINT TORIQUE
11	PAGB/T97.1-8	92995-08600	ARANDELA	WASHER	RONDELLA	RONDELLE
12	PAF4-04000001	97095-08020	PERNO	BOLT	BULLONE	BOULON
13	REC93608-12M05	93608-12M05	PASADOR	PIN	SPINOTTO	PIN
14	REC61A-45376-00-94	61A-45376-00-94	GUÍA DE SELLO DE GOMA	GUIDE	GUIDE	GUIDE
15	REC6AW-44315-00	6AW-44315-00	JUNTA	GASKET	GUARNIZIONE	JOINT
16	REC6AW-44323-00	6AW-44323-00	TAPA BOMBA	OUTER PLATE, CARTRIDGE	COPERCHIO POMPA D'ACQUA	PLAQUE DE POMPE À EAU
17	REC6AW-44352-00	6AW-44352-00	TURBINA	IMPELLER	GIRANTE	TURBINE
18	REC6AW-44322-00	6AW-44322-00	TAPA, BOMBA AGUA	COVER, INNER WATER PUMP	COPERCHIO, POMPE D'EAU	INSERT DE POMPE À EAU
19	REC93210-94003	93210-94003	TÓRICA	O-RING	O-RING	JOINT TORIQUE
20	REC93210-37160	93210-37160	TÓRICA	O-RING	O-RING	JOINT TORIQUE
21	REC93606-12019	93606-12019	PASADOR	PIN	SPINOTTO	PIN
22	REC6AW-44311-01	6AW-44311-00	CUERPO BOMBA AGUA	HOUSING, WATER PUMP	CORPO POMPA	CORPS DE POMPE À EAU
23	REC90119-08M14	90119-08M14	TORNILLO CON ARANDELA	SCREW WITH WASHER	VITE CON RONDELLA	VIS AVEC RONDELLE
24	REC6AW-44365-00	6AW-44365-00	GOMA DEL SELLO DE AGUA	DAMPER, WATER SEAL	ANELLO TUBO ACQUA	RETENUE TUBE D'EAU
25	REC6AW-44312-00	6AW-44312-00	CUBIERTA CAJA DE BOMBA DE AGUA	WATER PUMP COVER	COPERCHIO POMPA ACQUA	BAGUE DE POMPE À EAU
26	REC93340-67011	93340-67011	COJINETE	BEARING	CUSCINETTO	ROULEMENT
27	REC93501-04011	93501-04011	ESFERA	BALL	SFERA	BILLE
28	REC61A-45634-01	61A-45634-01	DESILIZADOR DE CAMBIO	SHIFT SLIDE	SCORREVOLE DEL CAMBIO	SHIFT
29	REC90183-02M03	90183-02M03	TUERCA DE RESORTE	SPRING NUT	DADO MOLLA	RONDELLE FREIN
30	REC6H1-45668-00	6H1-45668-00	EJE	SHAFT	ASSE	ARBRE
31	REC61A-45635-00	61A-45635-00	ÉMBOLO DE CAMBIO	SHIFT PLUNGER	GOMMINO	SHIFT
32	REC90501-10M77	90501-10M77	RESORTE DE COMPRESIÓN	SPRING	MOLLA	RESSORT
33	REC90201-02M00	90201-02M00	ARANDELA PLANA	WASHER	RONDELLA	RONDELLE
34	REC90171-18M04	90171-18M04	TUERCA	LOCK NUT	DADO	ÉCROU
35	REC91490-40030	91490-40030	PASADOR	PIN	SPINOTTO	CLAVETTE

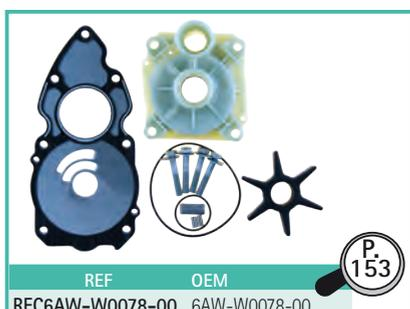

DESPIECE COLAS  
2 TIEMPOS

GEAR CASE PARTS  
2 STROKES

PARTI PIEDI  
2 TEMPI

PIECES D'EMBASES  
DE 2 TEMPS

2T 2HP • 2B • 2MSH • 2CMH  
STROKES

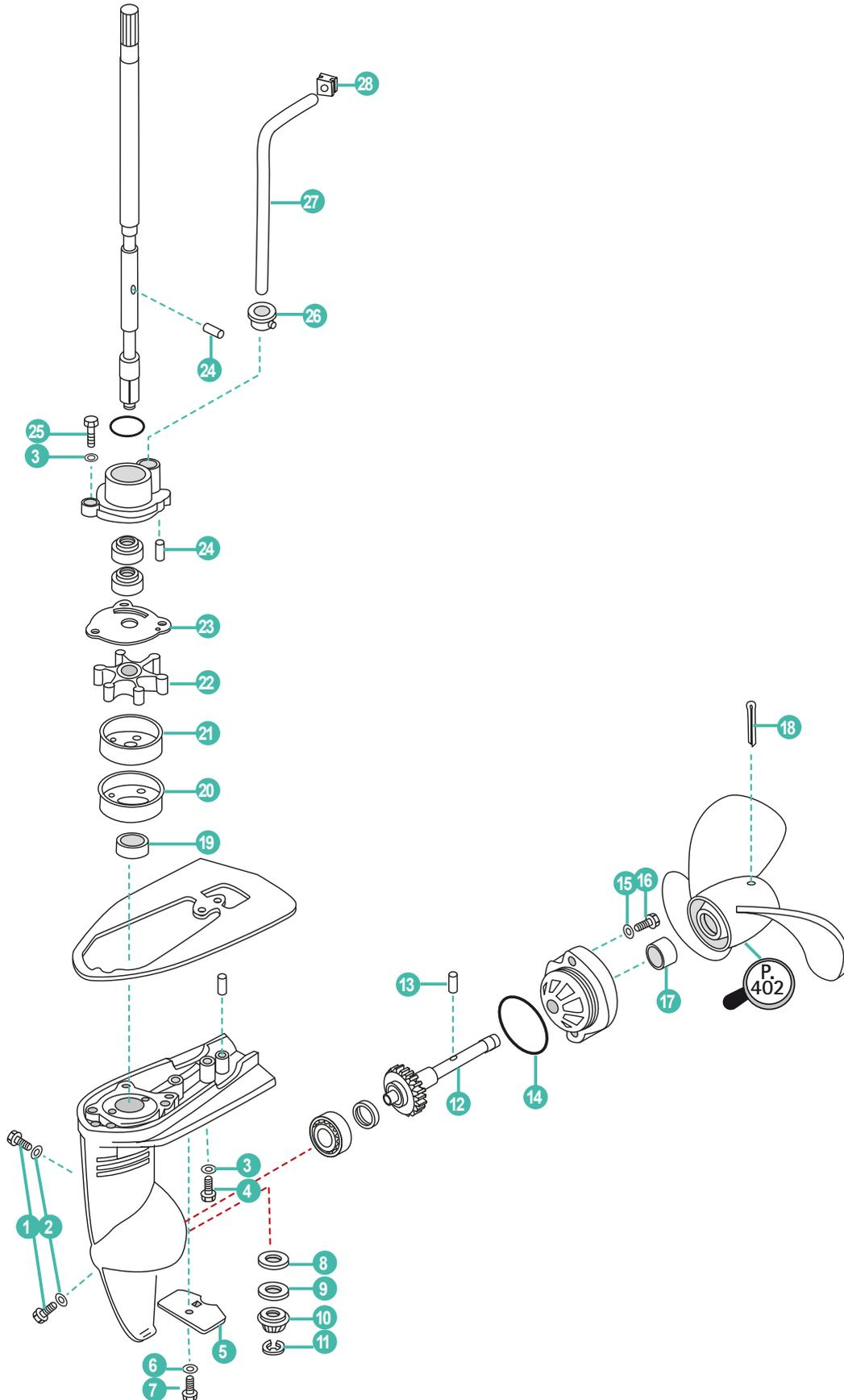



	REF	OEM				
1	REC90340-08002	90340-08M04	TORNILLO DRENAJE	BOLT, DISCHARGING OIL	VITE DRENAGGIO	BOUCHON DE VIDANGE
2	REC90430-08020	90430-08020	JUNTA	GASKET	GUARNIZIONE	JOINT
3	PAGB/T97.1-8	92995-08600	ARANDELA	WASHER	RONDELLA	RONDELLE
4	PAGB/T5783-M6X30	97095-06030	TORNILLO	BOLT	VITE	VIS
5	CM6L5-45251-02	6L5-45251-02	ÁNODO ZINC	ANODE	ANODO ZINCO	ANODE
6	PAGB/T861.1-87	92990-06300	ARANDELA	WASHER	RONDELLA	RONDELLE
7	PAGB/T5783-M6X35	95895-06012	TORNILLO	BOLT, FLANGE	VITE	VIS
8	PAF2.6-03000017	646-45534-00-03	GRUESO	SHIM	SPESSORE	CALE
9	PAF4-03000006	90201-11M49	ARANDELA	WASHER	RONDELLA	RONDELLE
10	REC646-45551-00	646-45551-00	PIÑÓN ATAQUE	INITIATIVE GEAR	MARCIA INIZIATIVA	PIGNON D'ATTAQUE
11	PAGB/T896-86	93430-06005	CLIP	CIRCLIP	CLIP	CLIP
12	REC646-45560-00	646-45560-00	ENGRANAJE CON EJE	GEAR WITH SHAFT	IGRANAGGIO CON ASSE	PIGNON
13	REC90250-03M10	90250-03M10	PASADOR SEGURIDAD	PIN	SPINOTTO	LEVIER
14	REC93210-42101	93210-42101	ARO TÓRICA	O-RING	O-RING	JOINT TORIQUE
15	PAGB/T97.1-6	92990-06600	ARANDELA	WASHER	RONDELLA	RONDELLE
16	PAGB/T5783-M6X16	97090-06014	TORNILLO	BOLT	VITE	VIS
17	REC93103-10052	93103-10052	RETÉN	OIL SEAL	PARAOLIO	JOINT SPI
18	REC91490-30040	91490-30040	PASADOR ALETAS	PIN	SPINOTTO	PIN
19	REC93103-11051	93103-11051	RETÉN	OIL SEAL	PARAOLIO	JOINT D'HUILE
20	REC6A1-44325-00	6A1-44325-00P	CUERPO INF. BOMBA	PROTECTOR	CORPO INF. POMPA	BASE DE POMPE À EAU
21	REC646-44322-00	646-44322-00	CASQUILLO INOX. BOMBA	INSERT	GHIERA INOX. POMPA	INSERT DE POMPE À EAU
22	REC646-44352-01	646-44352-01	TURBINA	IMPELLER	GIRANTE	TURBINE
23	REC646-44322-00	646-44323-00	PLATO BOMBA AGUA	OUTER PLATE	PIASTRA POMPA ACQUA	PLAQUE DE POMPE À EAU
24	PAF2.6-03000013	93604-09068	PIN	PIN	SPINOTTO	PIN
25	PAGB/T5783-M5X16	97095-05016	TORNILLO	BOLT	VITE	VIS
26	REC646-44366-01	646-44366-01	RETÉN TUBO AGUA	SEAL WATER PIPE	ANELLO TUBO ACQUA	RETENUE TUBE D'EAU
27	REC6A1-44361-00	6A1-44361-00	TUBO AGUA	TUBE, WATER	TUBO ACQUA	TUBE D'EAU
28	REC646-44365-00	646-44365-00	RETÉN TUBO DE AGUA	I-SHAPED RUBBER BAND	ANELLO TUBO ACQUA	RETENUE TUBE D'EAU



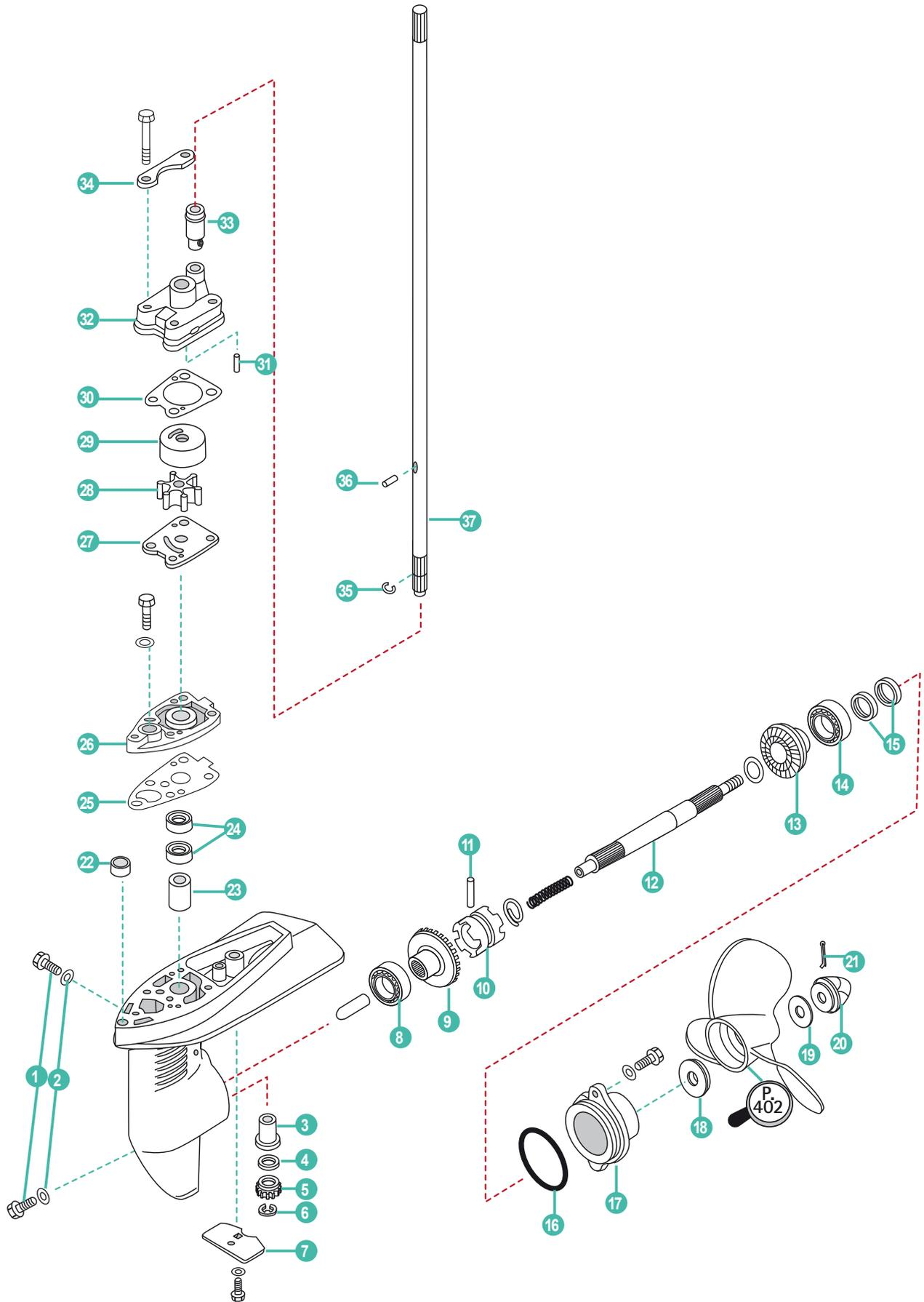



2T 6HP/C/MSH/CMH/CWH/MBK'07/D/DMH/DWH  
STROKES 8HP/C/MSH/MH/CMH/CWH

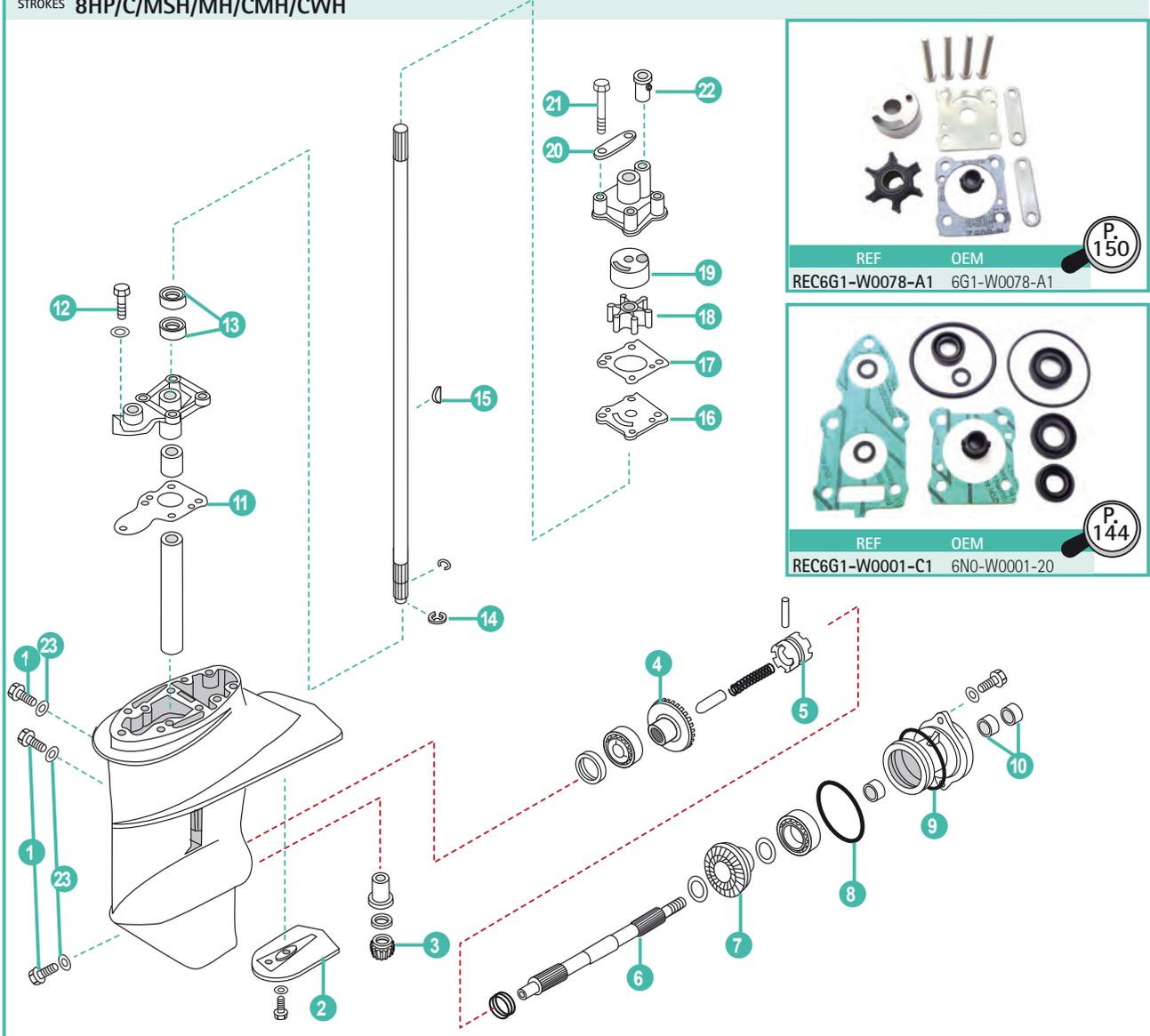

	REF	OEM				
1	REC90340-08002	6E0-45316-09	TAPÓN	PLUG	TAPPO	BOUCHON REMPLISSAGE D'HUILE
2	TEN01118	6N0-G5251-00	ÁNODO	ANODE	ANODO	ANODE
3	REC6N0-G5551-00	6N0-G5551-00	PIÑÓN ATAQUE	INITIATIVE GEAR	MARCIA INIZIATIVA	PIGNON D'ATTAQUE
4	REC6N0-G5560-00	6N0-G5560-00	PIÑÓN MARCHA AVANTE	POSITIVE GEAR ASSY	PIGNONE MARCIA AVANTI	PIGNON DE MARCHÉ AVANT
5	REC6G1-45631-00	6G1-45631-00	EMBRAGUE DE GARRA	CLUTCH, DOG	SELETTORE	CRABOT
6	REC6G1-45611-01	6G1-45611-01	EJE HÉLICE	SHAFT, PROPELLER	ASSE ELICA	ARBRE D'HELICE
7	REC6N0-G5571-00	6N0-G5571-00	PIÑÓN MARCHA ATRÁS	REVERSE GEAR	PIGNONE MARCIA INDIETRO	PIGNON MARCHÉ ARRIÈRE
8	REC93210-49046	93210-49046	ARO TÓRICO	O-RING	O-RING	JOINT TORIQUE
9	REC93210-53M08	93210-53M08	ARO TÓRICO	O-RING	O-RING	JOINT TORIQUE
10	REC93101-15074	93101-15074	RETÉN	OIL SEAL	PARAOLIO	JOINT SPI
11	REC6G1-45315-A0	6G1-45315-A0	JUNTA	PACKING, LOWER CASING	GUARNIZIONE	JOINT
12	PAGB/T5783-M6X30	97095-06030	TORNILLO	BOLT	VITE	VIS
13	REC93101-11M23	93101-11M23	RETÉN	OIL SEAL	PARAOLIO	JOINT SPI
14	REC99001-06600	99001-06600	CERCLIP	CIRCLIP	CIRCLIP	CIRCLIP
15	REC90280-03024	90280-03024	CHAVETA	KEY	CHIAVETTA	CLAVETTE
16	REC6G1-44323-00	6G1-44323-00	PLATO	OUTTER PLATE, CARTRIDGE	PIASTRA	PLAQUE DE POMPE À EAU
17	REC6G1-44315-A0	6G1-44315-A0	JUNTA	GASKET, WATER PUMP	GUARNIZIONE	JOINT
18	REC6G1-44352-00	6G1-44352-00	TURBINA	IMPELLER	GIRANTE	TURBINE
19	REC6G1-44322-00	6G1-44322-00	CASQUILLO	INSERT, CARTRIDGE	GHIERA	INSERT DE POMPE À EAU
20	REC6G1-44328-00	6G1-44328-00	PLACA FIJACIÓN BOMBA DE AGUA	PLATE, WATER PUMP FIXED	PLACCA DI FISSAGGIO POMPA ACQUA	PLAQUE FIXATION DE POMPE À EAU
21	REC97095-06045	97095-06045	TORNILLO	BOLT	VITE	VIS
22	REC647-44366-00	647-44366-00	CASQUILLO GOMA	DAMPER	GHIERA GOMA	BAGUE CAOUTCHOUC
23	REC90430-08020	90430-08020	JUNTA	GASKET	GUARNIZIONE	JOINT

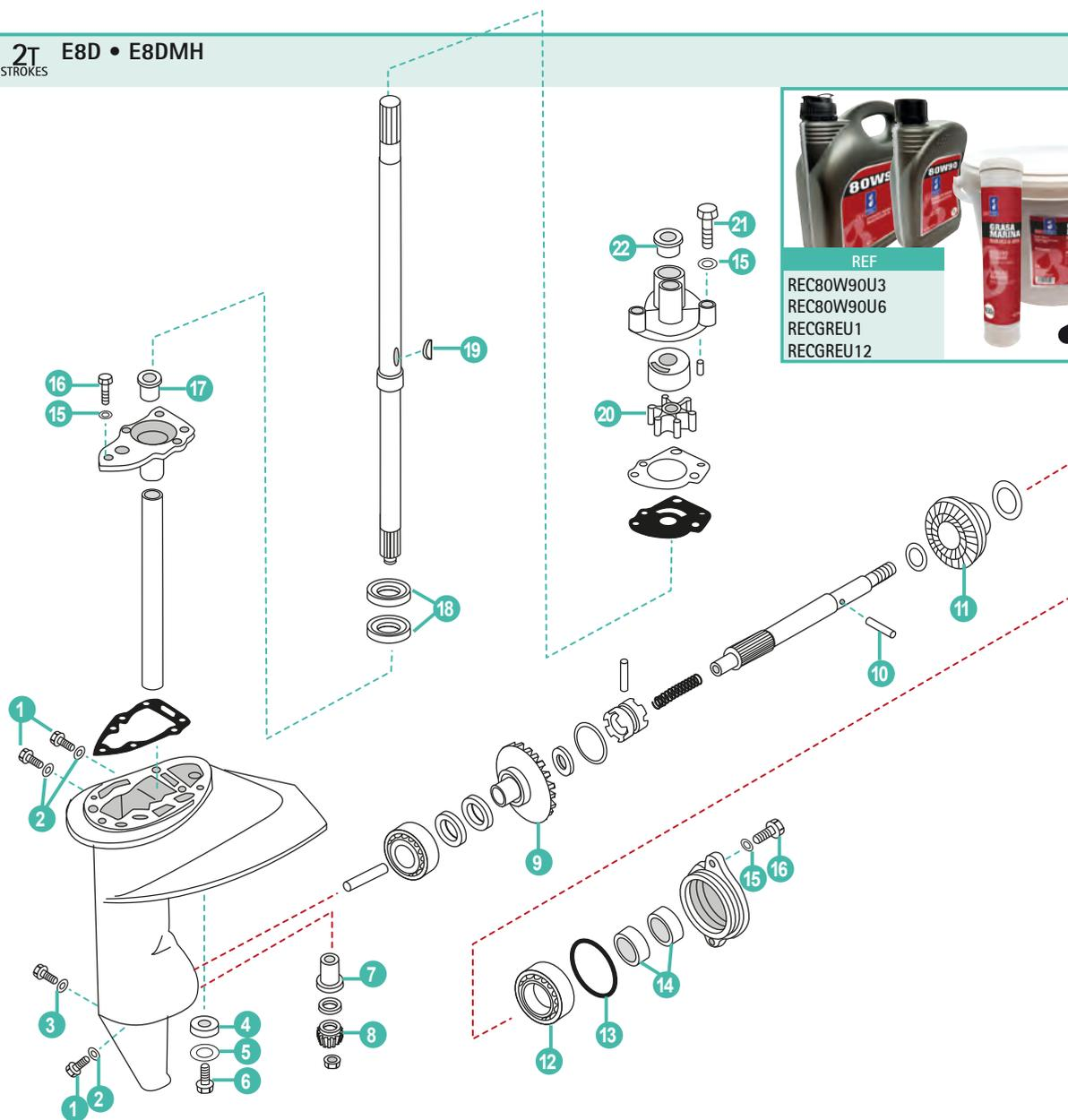

REF  
REC80W90U3  
REC80W90U6  
RECGREU1  
RECGREU12

	REF	OEM				
1	REC90340-08002	90340-08M04	TORNILLO	BOLT	VITE	VIS
2	REC90430-08020	90430-08020	JUNTA	GASKET	GUARNIZIONE	JOINT
3	REC90430-06M03	90430-06M03	JUNTA	GASKET	GUARNIZIONE	JOINT
4	CM6E0-45251-11	677-45251-00	ÁNODO	ANODE	ANODO	ANODE
5	PAGB/T861.1-87	92990-06300	ARANDELA	WASHER	RONDELLA	RONDELLE
6	PAGB/T5783-M6X35	95895-06012	TORNILLO	BOLT	VITE	VIS
7	REC647-45316-09	647-45316-09	CASQUILLO	DAMPER	GHIERA GOMA	PIN
8	REC647-45551-00	647-45551-00	PIÑÓN ATAQUE	INITIATIVE GEAR	MARCIA INIZIATIVA	PIGNON D'ATTAQUE
9	REC647-45560-00	647-45560-00	PIÑÓN MARCHA AVANTE	POSITIVE GEAR ASSY	PIGNONE MARCIA AVANTI	PIGNON DE MARCHÉ AVANT
10	REC90250-05036	90250-05036	PASADOR	PIN	SPINOTTO	PIN
11	REC647-45570-00	647-45570-01	PIÑÓN MARCHA ATRÁS	REVERSE GEAR	PIGNONE MARCIA INDIETRO	PIGNON MARCHÉ ARRIÈRE
12	REC93306-00519	93306-00519	COJINETE	BEARING	CUSCINETTO	ROULEMENT
13	REC93210-58677	93210-58677	ARO	O-RING	O-RING	JOINT TORIQUE
14	REC93101-15074	93101-15074	RETÉN ACEITE	OIL SEAL	PARAOLIO	JOINT SPI
15	PAGB/T97.1-6	92990-06600	ARANDELA	WASHER	RONDELLA	RONDELLE
16	PAGB/T5783-M6X20	97095-06020	PERNO	BOLT	VITE	VIS
17	REC647-45316-09	647-45316-09	CASQUILLO	BUSH	GHIERA	BAGUE
18	REC93101-18050	93101-18050	RETÉN ACEITE	OIL SEAL	PARAOLIO	JOINT SPI
19	REC90280-03024	90280-03024	CHAVETA	KEY	CHIAVETTA	CLAVETTE
20	REC662-44352-01	662-44352-01	IMPULSOR	IMPELLER	GIRANTE	TURBINE
21	REC97095-06040	97095-06040	PERNO	BOLT	VITE	VIS
22	REC647-44366-00	647-44366-00	GOMA	RUBER BAND	GOMMA	BAGUE

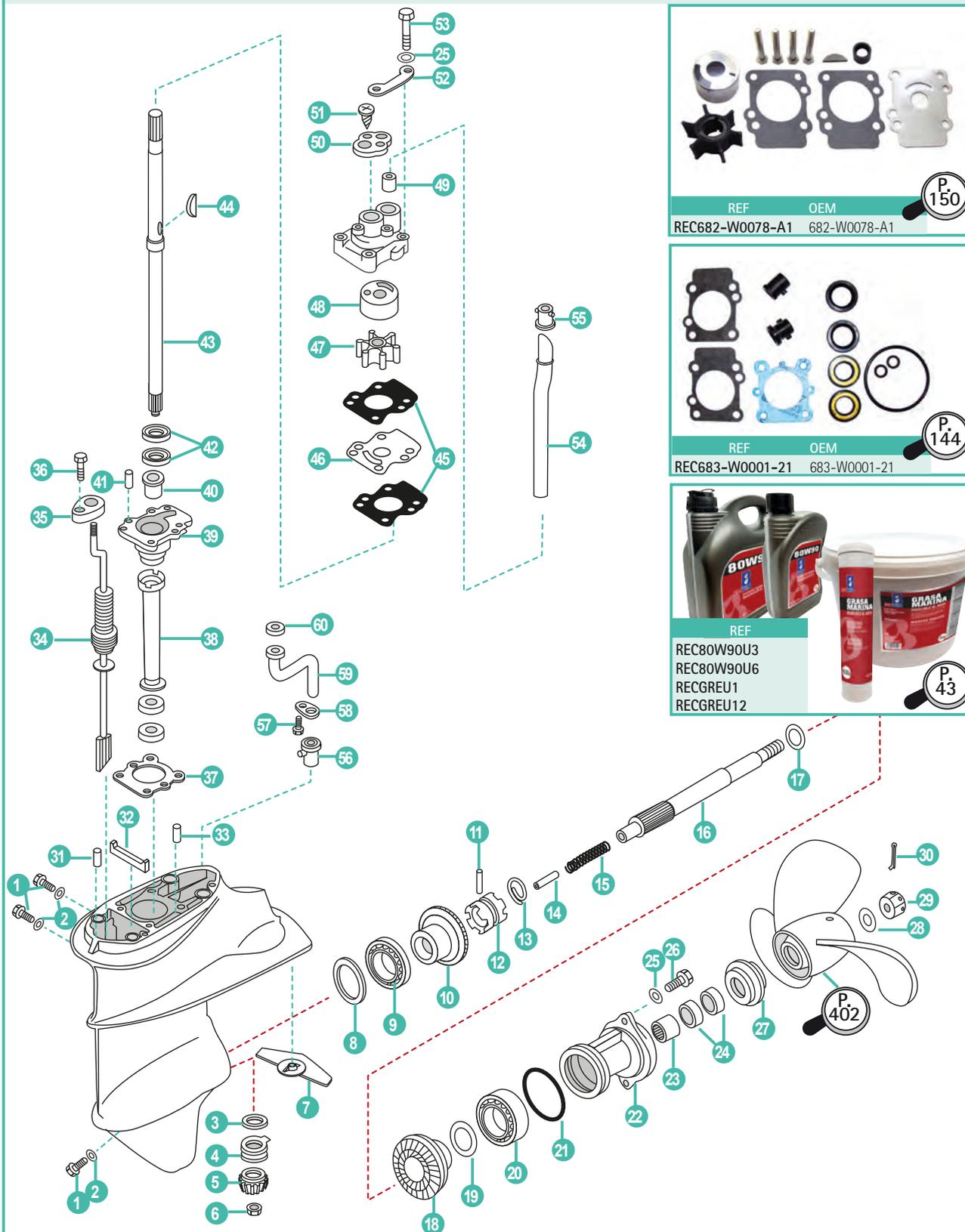

	REF	OEM				
1	REC90340-08002	90340-08014	TAPÓN	PLUG, STRAIGHT SCREW	TAPPO	BOUCHON DE VIDANGE
2	REC90430-08020	90430-08020	JUNTA	GASKET	GUARNIZIONE	JOINT
3	PAF15-06000009	6E7-45587-01-30	GRUESO (1.20mm)	SHIM (1.20mm)	SPESSORE (1.20mm)	CALE (1.20 mm)
4	REC93341-214U1	93341-214U1	RODAMIENTO	BEARING	CUSCINETTO	ROULEMENT
5	REC6E7-45551-00	6E7-45551-00	PIÑÓN ATAQUE	INITIATIVE GEAR	MARCIA INIZIATIVA	PIGNON D'ATTAQUE
6	REC90179-08M06	90179-08M06	TUERCA	NUT	DADO	ÉCROU
7	TEN01116	6B4-45251-00	ÁNODO	ANODE	ANODO	ANODE

	REF	OEM				
8	PAF15-06000010-1	664-45567-05	GRUESO (0.05mm)	SHIM (0.05mm)	SPESSORE (0.05mm)	CALE (0.05 mm)
	PAF15-06000010-2	664-45567-12	GRUESO (0.12mm)	SHIM (0.12mm)	SPESSORE (0.12mm)	CALE (0.12 mm)
	PAF15-06000010-5	664-45567-30	GRUESO (0.30mm)	SHIM (0.30mm)	SPESSORE (0.30mm)	CALE (0.30 mm)
	PAF15-06000010-7	664-4556-50	GRUESO (0.50mm)	SHIM (0.50mm)	SPESSORE (0.50mm)	CALE (0.50 mm)
9	REC93332-00005	93332-00005	RODAMIENTO	BEARING	CUSCINETTO	ROULEMENT
10	REC6E7-45560-01	6E7-45560-00	PIÑÓN MARCHA AVANTE	POSITIVE GEAR ASSY	PIGNONE MARCIA AVANTI	PIGNON DE MARCHE AVANT
11	REC90250-05010	90250-05010	PASADOR	PIN, STRAIGHT	SPINOTTO	PIN
12	REC682-45631-00	682-45631-00	EMBRAGUE DE GARRA	CLUTCH, DOG	SELETTORE	CRABOT
13	REC648-45633-00	648-45633-00	ANILLO	RING, CROSS PIN	O-RING	JOINT TORIQUE
14	REC650-45635-00	650-45635-00	PISTÓN	PLUNGER, SHIFT	PISTONE	PISTON
15	PAF15-06070002	90501-14M06	MUELLE	SPRING, COMPRESSION	MOLLA	RESSORT
16	REC683-45611-00	683-45611-00	EJE HÉLICE	SHAFT, PROPELLER	ASSE ELICA	ARBRE D'HELICE
17	REC90201-17682	90201-17682	ARANDELA	WASHER, PLATE	RONDELLA	RONDELLE
18	REC6E7-45570-00	6E7-45571-00	PIÑÓN MARCHA ATRÁS	REVERSE GEAR	PIGNONE MARCIA INDIETRO	PIGNON MARCHE ARRIÈRE
19	PAF15-06080006-1	626-45577-00-01	GRUESO (0.10mm)	SHIM (0.10mm)	SPESSORE (0.10mm)	CALE (0.10 mm)
	PAF15-06080006-3	626-45577-00-03	GRUESO (0.30mm)	SHIM (0.30mm)	SPESSORE (0.30mm)	CALE (0.30 mm)
	PAF15-06080006-5	626-45577-00-05	GRUESO (0.50mm)	SHIM (0.50mm)	SPESSORE (0.50mm)	CALE (0.50 mm)
20	REC93306-00501	93306-00501	RODAMIENTO	BEARING	CUSCINETTO	ROULEMENT
21	REC93210-57M09	93210-57M09	ARO TÓRICO	O-RING	O-RING	JOINT TORIQUE
22	REC683-45361-01-4D	683-45361-00-EJ	DIÁBOLO	CAP, LOWER CASING	COP. CASSA INGRANAGGI	DIABOLO
23	REC93315-317U2	93315-317U2	RODAMIENTO	BEARING	CUSCINETTO	ROULEMENT
24	REC93101-17054	93101-17054	RETÉN	OIL SEAL	PARAOLIO	JOINT SPI
25	PAGB/T97.1-16	92990-06600	ARANDELA	WASHER, PLATE	RONDELLA	RONDELLE
26	PAGB/T5783-M6X20	97395-06020	TORNILLO	BOLT	VITE	VIS
27	REC6E7-45987-00	6E7-45987-00	ESPACIADOR	SPACER	DISTANZIALE	ENTRETOISE
28	PAGB/T96-10	90201-10M01	SEPARADOR	SPACER	DISTANZIALE	CALE
29	PAF15-06000016	90171-10M01	TUERCA HÉLICE	NUT, CASTLE	DADO ELICA	ÉCROU
30	PAGB/T91-2.5X20	91490-30020	PASADOR ALETAS	PIN, COTTER	PIN ELICA	CLAVETTE
31	REC93606-12019	93606-12019	PIN	PIN	SPINOTTO	PIN
32	REC682-45376-01	682-45376-01	GUÍA RETÉN	GUIDE, SEAL DAMPER	GUIDA BOCCOLA	GUIDE
33	PAF25-04000007	93604-08062	PIN	PIN, DOWEL	SPINOTTO	PIN
34	REC682-44147-00	682-44147-00	TAPÓN GUÍA	BOOT, SHIFT ROD	TAPPO GUIDA	GUIDE
35	REC682-44176-00	682-44176-00	SOPORTE	BRACKET	SUPPORTO	SUPPORT
36	PAGB/T845-ST4.8X9	97780-50510	TORNILLO	SCREW	VITE	VIS
37	REC683-45315-A0	683-45315-00	JUNTA	PACKING, LOWER CASING	GUARNIZIONE	JOINT
38	REC6E7-45536-00	6E7-45536-00	CAMISA EJE	SLEEVE, DRIVE SHAFT	TUBO GUIDA	TUBE GUIDE
39	REC6E7-45331-00-CA	6E7-45331-00-9M	CUERPO DE RODAMIENTO	HOUSING, BEARING	CUSCINETTO	LOGEMENT
40	REC626-45316-09	626-45316-09	CASQUILLO	BUSHING, DRIVE SHAFT	GHIERA	BAGUE
41	REC93606-12019	93606-12019	PIN	PIN, DOWEL	SPINOTTO	PIN
42	REC93101-20048	93101-20048	RETÉN	OIL SEAL	PARAOLIO	JOINT SPI
43	REC6E7-45501-00	6E7-45501-00	EJE S	DRIVE SHAFT COMP. S	ASSE VERTICALE S	ARBRE VERTICAL S
	REC6E7-45501-11	6E7-45501-10	EJE L	DRIVE SHAFT COMP. L	ASSE VERTICALE L	ARBRE VERTICAL L
44	REC90280-03024	90280-03024	CHAVETA	KEY, WOODRUFF	CHIAVETTA	CLAVETTE
45	REC682-44315-00	682-44315-00	JUNTA	GASKET, WATER PUMP	GUARNIZIONE	JOINT
46	REC682-44323-40	682-44323-00	PLATO	OUTER PLATE, CARTRIDGE	PIASTRA	PLAQUE DE POMPE À EAU
47	REC682-44352-01	682-44352-00	TURBINA	IMPELLER	GIRANTE	TURBINE
48	REC682-44322-00	682-44322-00	CASQUILLO INOX.	INSERT, CARTRIDGE	GHIERA INOX.	INSERT DE POMPE À EAU
49	REC682-44365-00	682-44365-00	CASQUILLO GOMA	DAMPER, WATER SEAL	GHIERA GOMA	BAGUE
50	REC682-44312-00	682-44312-00	TAPA CUERPO BOMBA AGUA	COVER, WATER PUMP HOUSING	COPERCHIO CORPO ACQUA	CORPS DE POMPE À EAU
51	PAGB/T845-ST4.2X16	97780-40112	TORNILLO	SCREW, TAPPING	VITE	VIS
52	REC682-44328-00	682-44328-00	PLATO	PLATE	PIASTRA	PLAQUE
53	PAGB/T5782-M6X45	947395-06040	TORNILLO	BOLT	VITE	VIS
54	REC682-44361-01	682-44361-01	TUBO DE AGUA S	WATER TUBE S	TUBO ACQUA S	TUBE D'EAU S
	REC682-44361-10	682-44361-10	TUBO DE AGUA L	WATER TUBE L	TUBO ACQUA L	TUBE D'EAU L
55	REC626-44365-01	626-44365-01	RETÉN	SEAL	PARAOLIO	JOINT SPI
56	REC6E7-44366-00	6E7-44366-00	CASQUILLO GOMA	WATER SEAL	BOCCOLA GOMMA	GUIDE CAOUTCHOUC
57	PAGB/T5783-M6X10	97095-06010	TORNILLO	BOLT	VITE	VIS
58	REC683-44373-00	683-44373-00	PLACA FIJACION TUBO	PLATE WATER TUBE	PLACCA SUPPORTO TUBO	PLAQUE DE FIXATION DE TUBE
59	REC683-44362-01	683-44361-01	TUBO DE AGUA	WATER TUBE "B"	TUBO ACQUA	TUBE D'EAU
60	REC683-44365-01	683-44365-01	CASQUILLO GOMA	SEAL WATER TUBE	BOCCOLA GOMMA	GUIDE CAOUTCHOUC

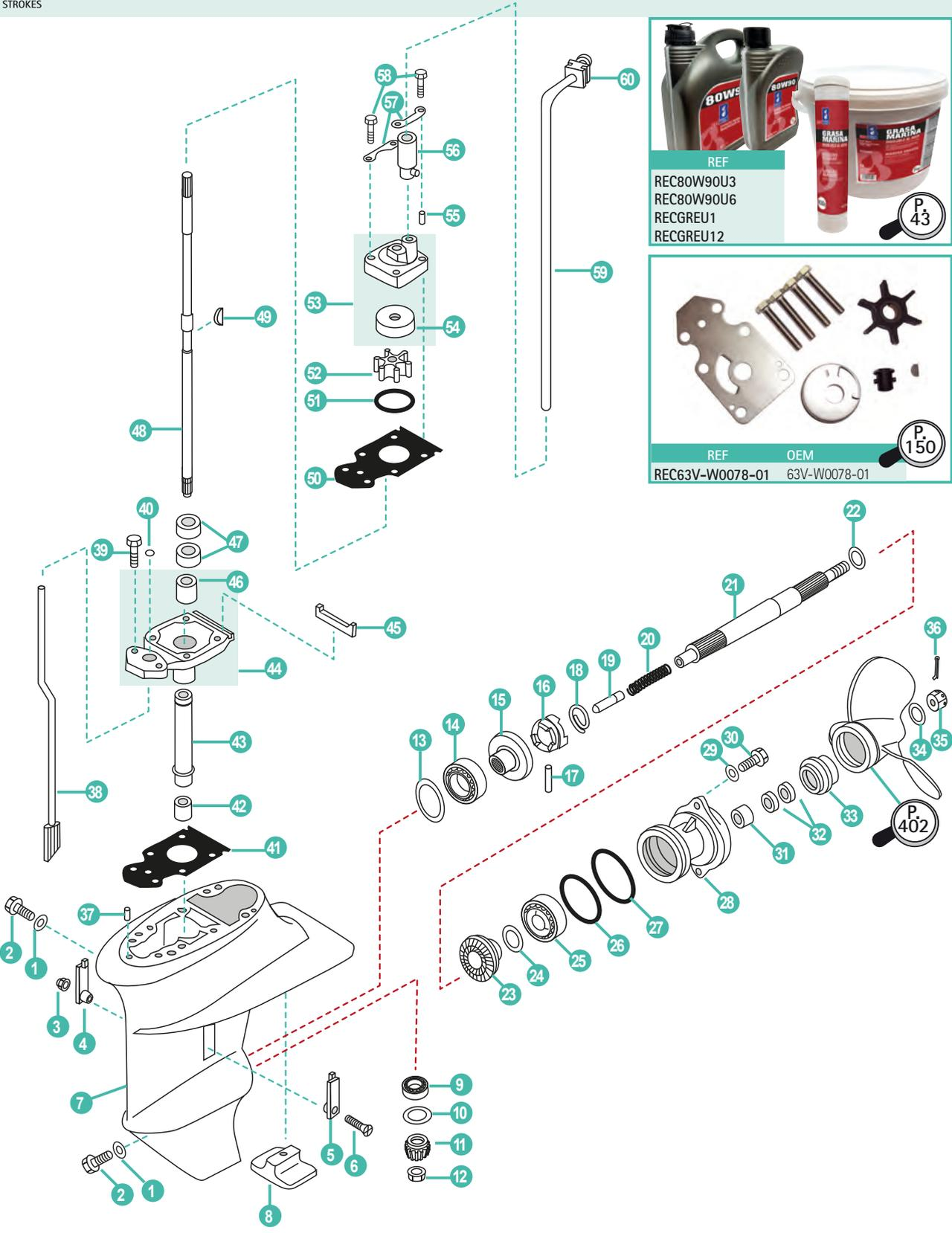

	REF	OEM				
1	REC90430-08020	90430-08020	ARANDELA	WASHER	RONDELLA	RONDELLE
2	REC90340-08002	90340-08002	TAPÓN ACEITE	PLUG, OIL	TAPPO OLIO	BOUCHON REMPLISSAGE D'HUILE
3	PAGB/T6182-M5	90185-05002	TUERCA	LOCK NUT	DADO	ÉCROU
4	PAF15-06000002	63V-45215-00	CUBIERTA ENTRADA AGUA A	WATER INLET A	COPERCHIO ACQUA A	GRILLE D'ENTREE D'EAU A
5	PAF15-06000003	6G1-45214-00	CUBIERTA ENTRADA AGUA B	WATER INLET B	COPERCHIO ACQUA B	GRILLE D'ENTREE D'EAU B
6	PAGB/T820-M5X25	90152-05M04	TORNILLO	SCREW	VITE	VIS



	REF	OEM				
7	PAF15-06000001	63V-45311-01-4D	CARTER	CASTING, LOWER	CARTER	CARTER D'EMBASE
8	CM61N-45251-01	61N-45251-01	ÁNODO	ANODE	ANODO	ANODE
9	REC93341-41414	93341-41414	RODAMIENTO	BEARING	CUSCINETTO	ROULEMENT
10	PAF15-06000008	6E8-45587-10-13	GRUESO (1.13 mm)	SHIM (1.13mm)	SPESSORE (1.13 mm)	CALE (1.13 mm)
11	REC63V-45551-00	63V-45551-00	PIÑÓN ATAQUE	INITIATIVE GEAR	MARCIA INIZIATIVA	PIGNON D'ATTAQUE
12	REC90179-08M06	90179-08M06	TUERCA	LOCK NUT	DADO	ÉCROU
13	PAF15-06000010-1	664-45567-01-10	GRUESO	SHIM	SPESSORE	CALE
14	REC93332-00005	93332-00005	COJINETE	BEARING	CUSCINETTO	ROULEMENT
15	REC6E7-45560-01	6E7-45560-01	PIÑÓN MARCHA AVANTE	POSITIVE GEAR ASSY	PIGNONE MARCIA AVANTI	PIGNON DE MARCHÉ AVANT
16	REC682-45631-00	682-45631-00	SELECTOR	CLUTCH BLOCK	SELETTORE	CRABOT
17	REC90250-05010	90250-05010	PASADOR	PIN	SPINOTTO	PIN
18	REC648-45633-00	648-45633-00	MUELLE SELECTOR	RING, CROSS PIN	MOLLA SELETTORE	RESSORT
19	REC650-45635-00	650-45635-00	ÉMBOLO	PLUNGER	BULLONE	PISTON
20	PAF15-06070002	90501-14M06	MUELLE	SPRING	MOLLA	RESSORT
21	REC683-45611-00	683-45611-00	EJE HÉLICE	PROPELLER SHAFT	ASSE ELICA	ARBRE D'HELICE
22	REC90201-17682	90201-17682	ARANDELA	WASHER	RONDELLA	RONDELLE
23	REC6E7-45570-00	6E7-45571-00	PIÑÓN MARCHA ATRÁS	REVERSE GEAR	PIGNONE MARCIA INDIETRO	PIGNON MARCHÉ ARRIÈRE
24	PAF15-06080006-1	626-45577-00	GRUESO	SHIM	SPESSORE	CALE
25	REC93306-00501	93306-00501	RODAMIENTO	BEARING (B6005)	CUSCINETTO	ROULEMENT
26	REC93210-57M09	93210-57M09	TÓRICA	O-RING	O-RING	JOINT TORIQUE
27	PAF15-06080003	93210-56M80	TÓRICA	O-RING	O-RING	JOINT TORIQUE
28	REC683-45361-01-4D	683-45361-02-4D	DIÁBOLO	CAP, LOWER CASING	COPERCHIO CARTER INFERIORE	DIABOLO
29	PAGB/T97.1-6	92995-06600	ARANDELA	WASHER	RONDELLA	RONDELLE
30	PAGB/T5783-M6X20	97095-06020	TORNILLO	SCREW	VITE	VIS
31	REC93315-317U2	93315-317U2	COJINETE	BEARING	CUSCINETTO	ROULEMENT
32	REC93101-17054	93101-17054	RETÉN DE ACEITE	OIL SEAL	PARAOLIO	JOINT SPI
33	PAF15-06000015	6E7-45987-01	ESPACIADOR	SPACER	DISTANZIALE	ENTRETOISE
34	REC6E7-45987-00	6E7-45987-01	SEPARADOR	SPACER	DISTANZIALE	ENTRETOISE
35	REC90171-10M01	90171-10M01	TUERCA HÉLICE	NUT, CASTLE	DADO ELICA	ÉCROU
36	REC91490-30025	91490-30020	PASADOR ALETAS	PIN, COTTER	PIN ELICA	CLAVETTE
37	PAF15-00000013	93604-10M03	PIN	PIN	SPINOTTO	PIN
38	PAF15-06030000S	63V-44150-00	EJE SELECTOR S	SHIFT CAM ASSY S	ASSE SELETTORE S	ARBRE SELECTEUR S
	PAF15-06030000L	63V-44150-10	EJE SELECTOR L	SHIFT CAM ASSY L	ASSE SELETTORE L	ARBRE SELECTEUR L
39	PAGB/T5783-M8X25	97080-08025	TORNILLO	SCREW	VITE	VIS
40	REC93210-06ME6	93210-06ME6	TÓRICA	O-RING	O-RING	JOINT TORIQUE
41	REC63V-45315-AO	63V-45315-AO	JUNTA	GASKET	GUANIZIONE	JOINT
42	REC93315-314V8	93315-314V8	COJINETE	BEARING	CUSCINETTO	PALIER
43	PAF15-06000006	63V-45536-00	TUBO GUÍA	SLEEVE, DRIVE SHAFT	TUBO GUIDA	TUBE
44	REC63V-45331-00-5B	63V-45331-00-5B	CUERPO DEL COJINETE	SHELL, BEARING	CORPO DE CUSCINETTO	LOGEMENT DE PALIER
45	PAF15-06020005	63V-45375-00	GOMA	SEAL	GOMMA	TAMPON
46	REC626-45316-09	90381-14020	CASQUILLO	BUSH, SOLID	BOCCOLA	BAGUE
47	REC93101-20048	93101-20048	RETÉN DE ACEITE	OIL SEAL	PARAOLIO	JOINT SPI
48	REC63V-45510-01	63V-45510-01	EJE VERTICAL S	DRIVE SHAFT ASSY S	ASSE VERTICALE S	ARBRE VERTICAL S
	REC63V-45510-11	63V-45510-11	EJE VERTICAL L	DRIVE SHAFT ASSY L	ASSE VERTICALE L	ARBRE VERTICAL L
49	REC664-44338-00	63V-44338-00	CHAVETA	KEY, WOODRUFF	CHIAVETTA	CLAVETTE
50	REC63V-44323-00	63V-44323-00	JUNTA TAPA BOMBA AGUA	GASKET, WATER PUMP COVER	GUARNIZIONE COPERCHIO	JOINT COUVERCLE
51	PAJASOF404-31-045	93210-44398	ARO TÓRICO	O-RING	O-RING	JOINT TORIQUE
52	REC63V-44352-01	63V-44352-01	TURBINA	IMPELLER	GIRANTE	TURBINE
53	REC63V-44301-00	63V-44301-00	CUERPO DE BOMBA	PUMP HOUSING	CORPO POMPA	CORPS DE POMPE À EAU
54	REC63V-44322-00	63V-44322-00	TAPA, BOMBA AGUA	COVER, INNER WATER PUMP	COPERCHIO, POMPE ACQUA	INSERT DE POMPE À EAU
55	PAF15-00000013	93604-12M07	PASADOR	PIN	SPINOTTO	PIN
56	REC647-44366-00	647-44366-00	TUBO GOMA BOMBA AGUA	RUBBER TUBE, WATER PUMP	TUBO IN GOMMA, POMPA	DURITE DE COUTCHOU
57	PAF15-06000014	63V-44328-00	PLACA	OUT PLATE	PIASTRA	PLAQUE
58	REC97080-08045	97080-08045	PERNO	STUD	BULLONE	BOULON
59	REC63V-44361-01	63V-44361-01	TUBO DE AGUA S	WATER TUBE S	TUBO DELL'ACQUA S	DURITE D'EAU S
	REC63V-44361-11	63V-44361-11	TUBO DE AGUA L	WATER TUBE L	TUBO DELL'ACQUA L	DURITE D'EAU L
60	PAF15-02000006	63V-44365-10	GOMA DEL TUBO DE AGUA	I-SHAPED RUBBER BAND	GOMMA TUBO ACQUA	PLOT CAOUTCHOU DE TUBE D'EAU

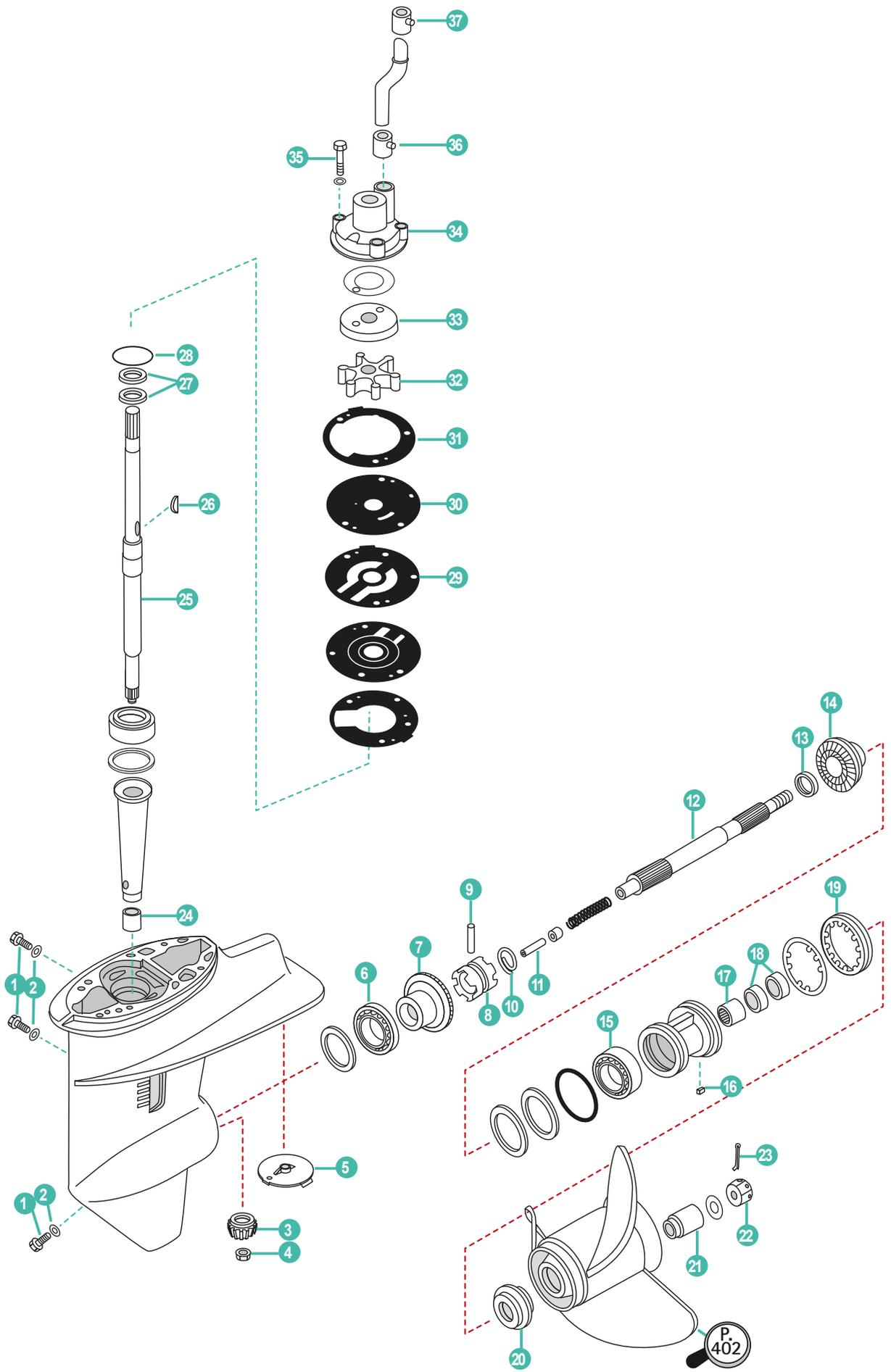

	REF	OEM				
1	REC90340-08002	90340-08002	TAPÓN ACEITE	PLUG, OIL	TAPPO OLIO	BOUCHON REMPLISSAGE D'HUILE
2	REC90430-08020	90430-08020	ARANDELA	WASHER	RONDELLA	RONDELLE
3	REC689-45551-00	689-45551-00	PIÑÓN ATAQUE	INITIATIVE GEAR	MARCIA INIZIATIVA	PIGNON D'ATTAQUE
4	REC90179-09M02	90179-09M02	TUERCA, PIÑÓN	NUT	DADO	ÉCROU
5	CM664-45371-01	664-45371-01-00	ÁNODO	ANODE	ANODO	ANODE
6	REC93332-00005	93332-00005	COJINETE	BEARING	CUSCINETTO	ROULEMENT
7	REC689-45560-00	689-45560-00	PIÑÓN MARCHA AVANTE	POSITIVE GEAR ASSY	PIGNONE MARCIA AVANTI	PIGNON DE MARCHÉ AVANT
8	REC664-45631-01	664-45631-01	SELECTOR	CLUTCH	SELETTORE	CRABOT
9	REC90250-05010	90250-05010	PASADOR	PIN	SPINOTTO	LEVIER
10	REC648-45633-00	648-45633-00	ARO, PASADOR	CROSS PIN	O-RING	JOINT TORIQUE
11	REC648-45635-00	648-45635-00	PIVOTE	PIN	PERNO	ARBRE
12	REC689-45611-00	689-45611-00	EJE HÉLICE	SHAFT PROPELLER	ASSE ELICA	ARBRE D'HELICE
13	REC90201-20417	90201-20417	ARANDELA	WASHER	RONDELLA	RONDELLE
14	REC689-45571-00-00	689-45570-00	PIÑÓN MARCHA ATRÁS	REVERSE GEAR	PIGNONE MARCIA INDIETRO	PIGNON MARCHÉ ARRIÈRE
15	REC93306-00612	93306-00612	COJINETE	BEARING	CUSCINETTO	ROULEMENT
16	REC90282-04010	90282-04010	CHAVETA	KEY	CHIAVETTA	CLAVETTE
17	REC93315-22004	93315-22004	COJINETE	BEARING	CUSCINETTO	ROULEMENT
18	REC93101-20M07	93101-20M07	RETÉN	OIL SEAL	PARAOLIO	JOINT D'HUILE
19	REC664-45384-00	664-45384-00	TUERCA	NUT	DADO	ÉCROU
20	REC664-45987-00	664-45987-00	ESPACIADOR	SPACER	DISTANZIALE	CALE
21	REC689-45997-00	689-45997-00	ESPACIADOR	SAPCER	DISTANZIALE	CALE
22	REC90171-14013-00	90171-14013	TUERCA HÉLICE	NUT	DADO	ÉCROU
23	REC91490-30030	91490-30030	PASADOR	COTTER PIN	PIN	PIN
24	REC93315-017U4	93315-017U4	COJINETE, PIÑÓN	BEARING	CUSCINETTO	ROULEMENT
25	REC689-45501-10	689-45501-10	EJE L	DRIVE SHAFT L	ASSE VERTICALE L	ARBRE VERTICAL L
26	REC664-44338-00	664-44338-00	CUÑA	CHAVETA	KEY	CHIAVETTA
27	REC93101-22067	93101-22067	RETÉN ACEITE	OIL SEAL	PARAOLIO	JOINT SPI
28	REC689-44315-A0	689-44315-A0	JUNTA BASE	GASKET	GUARNIZIONE	JOINT
29	REC689-44316-A0	689-44316-A0	JUNTA BASE	GASKET	GUARNIZIONE	JOINT
30	REC689-44323-00	689-44323-03	CHAPA	PLATE	PIASTRA	PLAQUE
31	REC689-44324-A0	689-44324-A0	JUNTA, CHAPA	GASKET	GUARNIZIONE	JOINT
32	REC689-44352-02	689-44352-02	IMPULSOR	IMPELLER	GIRANTE	TURBINE
33	REC689-W4432-01	689-W4432-02	ACOPLE	INSERT CUP	ACCOPPIAMENTO	INSERT DE POMPE À EAU
34	REC689-44311-00	689-44311-03	CUERPO BOMBA AGUA	HOUSING W.P.	CORPO POMPA ACQUA	CORPS DE POMPE
35	REC90101-06M56	90101-06M56	TORNILLO CUERPO BOMBA	BOLT	VITE	VIS
36	REC626-44365-01	626-44365-01	RETÉN SUPERIOR TUBO DE AGUA	DUMPER WATER TUBE	PARAOLIO SUPERIORE TUBO ACQUA	BAGUE TUBE D'EAU
37	REC689-44366-00	689-44366-00	RETÉN SUPERIOR TUBO DE AGUA	DUMPER WATER TUBE	PARAOLIO SUPERIORE TUBO ACQUA	BAGUE TUBE D'EAU



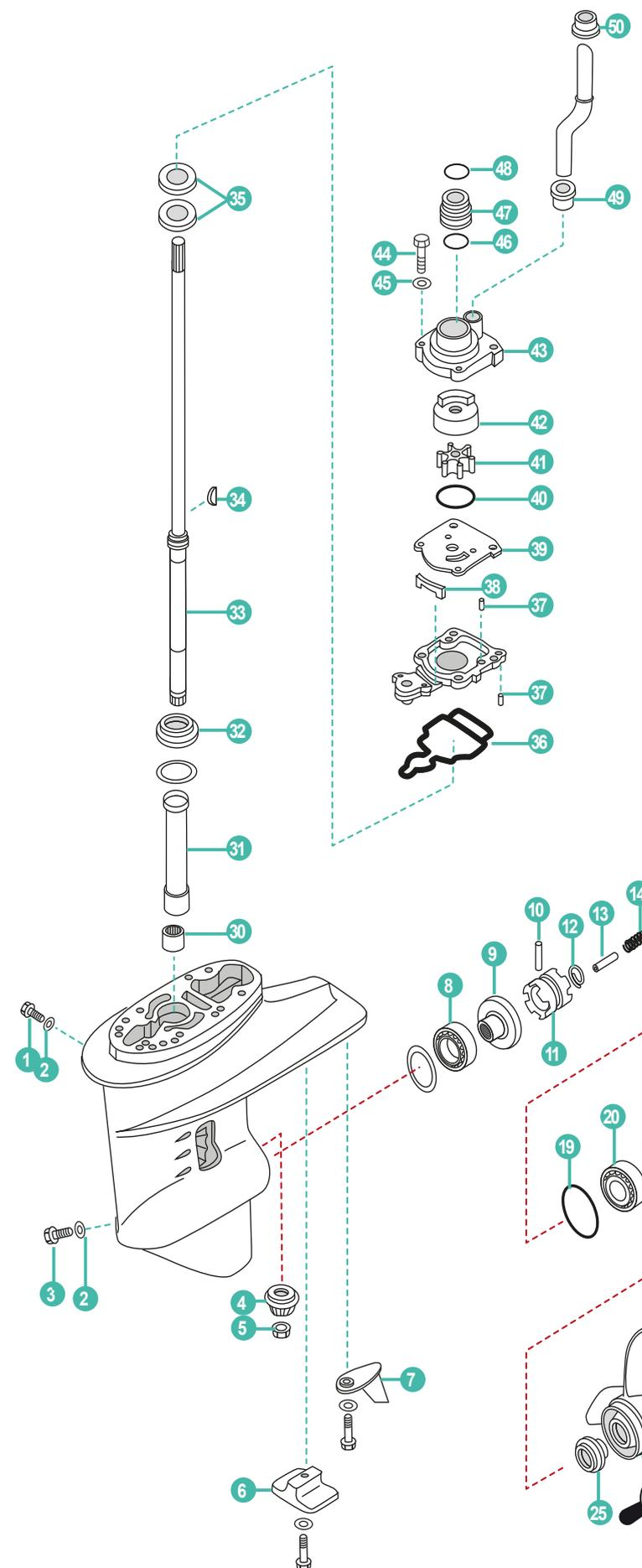

REF	OEM
REC61N-W0001-E1	61N-W0001-E1

REF	OEM
REC61N-W0078-11	61N-W0078-11

REF
REC80W90U3
REC80W90U6
RECGREU1
RECGREU12

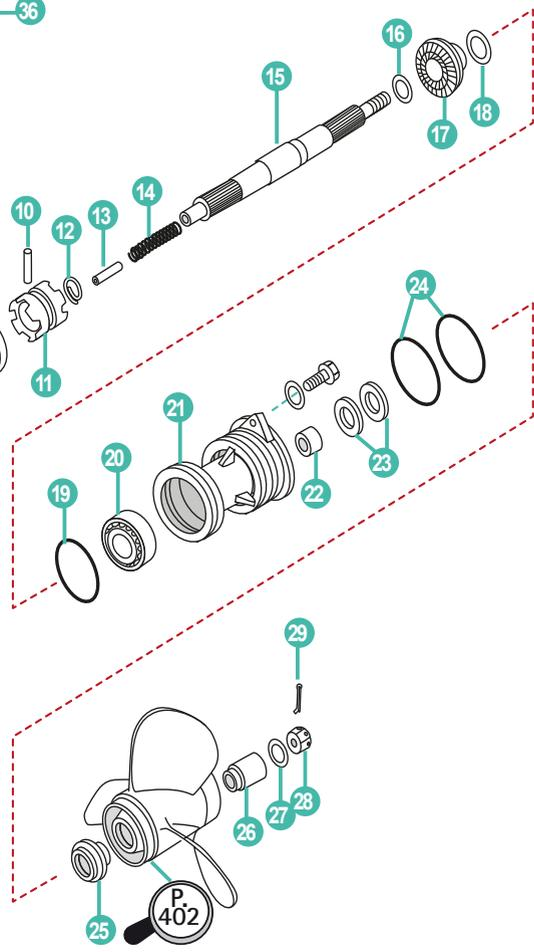

	REF	OEM				
1	REC90340-08002	90340-08002	TAPÓN	PLUG, STRAIGHT SCREW	TAPPO	BOUCHON
2	REC90430-08020	90430-08020	JUNTA	GASKET	GUARNIZIONE	JOINT
3	REC688-45341-00	688-45341-10	TAPÓN VACIADO	PLUG, DRAIN	TAPPO	BOUCHON
4	REC61N-45551-00	61N-45551-00	PIÑÓN ATAQUE	INITIATIVE GEAR	MARCIA INIZIATIVA	PIGNON D'ATTAQUE
5	REC90179-10M14	90179-10M14	TUERCA	NUT	DADO	ÉCROU
6	CM61N-45251-01	61N-45251-01	ÁNODO	ANODE	ANODO	ANODE
7	TEN01130	61N-45371-00	ÁNODO ZINC	TAB-TRIM	ANODO ZINCO	ANODE
8	REC93332-00005	93332-00005	RODAMIENTO	BEARING	CUSCINETTO	ROULEMENT
9	REC61N-45560-10	61N-45560-10	PIÑÓN MARCHA AVANTE	POSITIVE GEAR ASSY	PIGNONE MARCIA AVANTI	PIGNON DE MARCHÉ AVANT
10	REC90250-05010	90250-05010	PASADOR	PIN, STRAIGHT	SPINOTTO	PIN
11	REC664-45631-00	664-45631-02	DEAPLAZABLE	CLUTCH, DOG	SCORREVOLE	CRABOT
12	REC648-45633-00	648-45633-00	MUELLE	RING, CROSS PIN	MOLLA	RESSORT
13	REC648-45635-00	648-45635-00	BULÓN	PLUNGER, SHIFT	BULLONE	BOULON
14	PAF25-04060002	90501-10065	MUELLE COMPRESIÓN	SPRING, COMPRESSION	MOLLA	RESSORT
15	REC6L2-45611-00	6L2-45611-00	EJE HÉLICE	SHAFT, PROPELLER	ASSE ELICA	ARBRE D'HELICE
16	REC90201-20417	90201-20417	ARANDELA	WASHER, PLATE	RONDELLA	RONDELLE
17	REC61N-45571-00	61N-45571-00	PIÑÓN MARCHA ATRÁS	REVERSE GEAR	PIGNONE MARCIA INDIETRO	PIGNON MARCHE ARRIÈRE
18	PAF25-04070005-1	6L2-45577-00-10	GRUESO (1.0 mm)	SHIM (t:1.0mm)	SPESSORE (1.0 mm)	CALE (1.0 mm)
19	REC93210-64ME7	93210-64ME7	ARO TÓRICO	O-RING	O-RING	JOIN TORIQUE
20	REC93306-00612	93306-00612	RODAMIENTO	BEARING	CUSCINETTO	ROULEMENT
21	PAF25-04070001	61N-45361-01-4D	DIÁBOLO	CAP, LOWER CASING	COP. CASSA INGRANAGGI	DIABOLO
22	REC93315-22004	93315-22004	RODAMIENTO	BEARING	CUSCINETTO	ROULEMENT
23	REC93101-20M07	93101-20M07	RETÉN	OIL SEAL	PARAOLIO	JOINT SPI
24	REC93210-65M50	93210-65M50	ARO TÓRICO	O-RING	O-RING	JOINT TORIQUE
25	REC6L2-45987-00	6L2-45987-01	SEPARADOR	SPACER	DISTANZIALE	CALE
26	REC689-45997-00	689-45997-00	SEPARADOR	SPACER	DISTANZIALE	CALE
27	PAGB/T97.1-14	92990-14200	ARANDELA	WASHER, PLAIN	RONDELLA	RONDELLE
28	REC90171-14013-00	90171-14013	TUERCA	NUT, CASTLE	DADO	ÉCROU
29	PAGB/T91-1.6x12	91490-30022	PASADOR	PIN	SPINOTTO	PIN
30	REC93315-220V7	93315-220V7	RODAMIENTO	BEARING	CUSCINETTO	ROULEMENT
31	PAF25-04000002	61N-45536-00	TUBO GUÍA	SLEEVE, DRIVE SHAFT	TUBO GUIDA	TUBE GUIDE
32	REC93332-000W5	93332-000WS	RODAMIENTO	BEARING	CUSCINETTO	ROULEMENT
33	REC61N-45510-00	61N-45510-00	EJE VERTICAL S	DRIVE SHAFT ASSY S	ASSE VERTICALE S	ARBRE VERTICAL S
	REC61N-45510-10	61N-45510-10	EJE VERTICAL L	DRIVE SHAFT ASSY L	ASSE VERTICALE L	ARBRE VERTICAL L
34	REC90280-03M03	90280-03M03	CHAVETA	KEY, WOODRUFF	CHIAVETTA	CLAVETTE
35	REC93101-22067	93101-22067	RETÉN	OIL SEAL	PARAOLIO	JOINT SPI
36	PAF25-04000009	61N-45315-00	JUNTA	PACKING, LOWER CASING	GUARNIZIONE	JOINT
37	PAF25-04000007	93604-10M03	PIN CENTRADO	PIN, DOWEL	SPINOTTO	PIN
38	PAF25-04000013	61N-45127-00	RETÉN	SEAL	PARAOLIO	JOINT SPI
39	REC61N-44323-00	61N-44323-00	PLATO BOMBA AGUA	OUTTER PLATE, CARTRIDGE	PIASTRA POMPA ACQUA	PLAQUE
40	PAF25-04050003	93210-45161	ARO TÓRICO	O-RING	O-RING	JOINT TORIQUE
41	REC6H4-44352-02	6H4-44352-02	TURBINA	IMPELLER	GIRANTE	TURBINE
42	REC61N-44322-00	61N-44322-01	CASQUILLO INOX.	INSERT, CARTRIDGE	BOCCOLA INOX.	INSERT DE POMPE À EAU
43	PAF25-04050001	61N-44311-01	CUERPO BOMBA	HOUSING, WATER PUMP	CORPO POMPA	CORPS DE POMPE À EAU
44	REC97095-06040	97095-06040	TORNILLO	BOLT	VITE	VIS
45	PAGB/T97.1-6	92995-06600	ARANDELA	WASHER	RONDELLA	RONDELLE
46	PAGB/T3452.1-25.8X2	93210-26130	ARO TÓRICO	O-RING	O-RING	JOINT TORIQUE
47	PAF25-04000017S	61N-44362-00	TUBO AGUA S	WATER TUBE S	TUBO ACQUA S	TUBE D'EAU S
	PAF25-04000017	61N-44362-10	TUBO AGUA L	WATER TUBE L	TUBO ACQUA L	TUBE D'EAU L
48	PAGB/T3452.1-25.8X2	93210-22164	ARO TÓRICO	O-RING	O-RING	JOINT TORIQUE
49	PAF25-04050004	6L2-44367-00	CASQUILLO	DAMPER WATER PIPE	BOCCOLA	BAGUE TUBE D'EAU
50	REC689-44366-00	689-44366-00	CASQUILLO	DAMPER, WATER SEAL	BOCCOLA	BAGUE TUBE D'EAU



	REF	OEM				
1	REC90340-08002	90340-08002	TAPÓN	PLUG, STRAIGHT SCREW	TAPPO	BOUCHON DE VIDANGE
2	REC90430-08020	90430-08020	JUNTA	GASKET	GUARNIZIONE	JOINT
3	REC90179-10M14	90179-10M14	TUERCA	NUT	DADO	ECROU
4	CM664-45371-01	664-45371-01	ÁNODO DERIVA	TAB-TRIM	ANODO	ANODE
5	PAF25-04060002	90501-10065	MUELLE	SPRING, COMPRESSION	MOLLA	RESSORT
6	REC90250-05010	90250-05010	PASADOR	PIN, STRAIGHT	SPINOTTO	PIN
7	REC648-45633-00	648-45633-00	ARO	RING CROSS PIN	O-RING	JOINT TORIQUE
8	REC90201-20417	90201-20417	ARANDELA	WASHER, PLATE	RONDELLA	RONDELLE
9	REC93210-60MA3	93210-60MA3	ARO TÓRICO	O-RING	O-RING	JOINT TORIQUE
10	REC93306-00612	93306-00612	RODAMIENTO	BEARING	CUSCINETTO	ROULEMENT
11	REC90282-04010	90282-04010	CHAVETA	KEY, STRAIGHT	CHIAVETTA	CLAVETTE
12	REC93315-22004	93315-22004	RODAMIENTO	BEARING	CUSCINETTO	ROULEMENT
13	REC93101-20M07	93101-20M07	RETÉN	OIL SEAL	PARAOLIO	JOINT SPI
14	REC664-45384-00	664-45384-00	TUERCA	NUT	DADO	EROU
15	REC6L2-45987-00	6L2-45987-01	DISTANCIADOR	SPACER	DISTANZIALE	ENTRETOISE
16	REC689-45997-00	689-45997-00	DISTANCIADOR	SPACER	DISTANZIALE	ENTRETOISE
17	PAGB/T97.1-14	92990-14200	ARANDELA	WASHER, PLAIN	RONDELLA	RONDELLE
18	REC90171-14013-00	90171-14013	TUERCA HÉLICE	NUT, CASTLE	DADO	ECROU D'HELICE
19	REC91490-30025	91490-30025	PIN	PIN	SPINOTTO	CLAVETTE
20	REC682-44147-00	682-44147-00	TAPÓN GUÍA	BOOT, SHIFT ROD	TAPPO	GUIDE
21	REC93315-220V7	93315-220V7	RODAMIENTO	BEARING	CUSCINETTO	ROULEMENT
22	REC93332-00001	93332-00001	RODAMIENTO	BEARING	CUSCINETTO	ROULEMENT
23	REC90280-03024	90280-03024	CHAVETA	KEY, WOODRUFF	CHIAVETTA	CLAVETTE
24	REC93101-23070	93101-23070	RETÉN	OIL SEAL	PARAOLIO	JOINT SPI
25	REC93210-41042	93210-41042	ARO TÓRICO	O-RING	O-RING	JOINT TORIQUE
26	REC663-44316-A0	663-44316-A0	JUNTA	GASKET, WATER PUMP	GUARNIZIONE	JOINT
27	REC663-44324-00	663-44324-A0	JUNTA	GASKET, CARTRIDGE	GUARNIZIONE	JOINT
28	PAF25-04000007	93604-08062	PIN	PIN	SPINOTTO	PIN
29	REC663-44323-00	663-44323-00	PLATO BOMBA AGUA	OUTTER PLATE	PIASTRA POMPA ACQUA	PLAQUE DE POMPE À EAU
30	REC663-44315-A0	663-44315-A0	JUNTA	GASKET, WATER PUMP	GUARNIZIONE	JOINT
31	REC6H4-44352-02	6H4-44352-02	TURBINA	IMPELLER	GIRANTE	TURBINE
32	REC663-44322-00	663-44322-00	CASQUILLO INOX	INSERT, CARTRIDGE	BOCCOLA INOX.	INSERT DE POMPE À EAU
33	REC663-44366-00	663-44366-00	CASQUILLO GOMA	DAMPER, WATER SEAL	BOCOLLA GOMMA	BAGUE
34	REC663-44311-02	6J8-44311-00	CUERPO BOMBA AGUA	HOUSING, WATER	CORPO POMPA ACQUA	CORPS DE POMPE À EAU
35	REC90119-08M13	90119-08M13	TORNILLO	BOLT, WITH WASHER	VITE	VIS

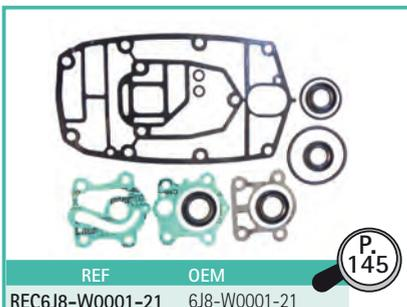

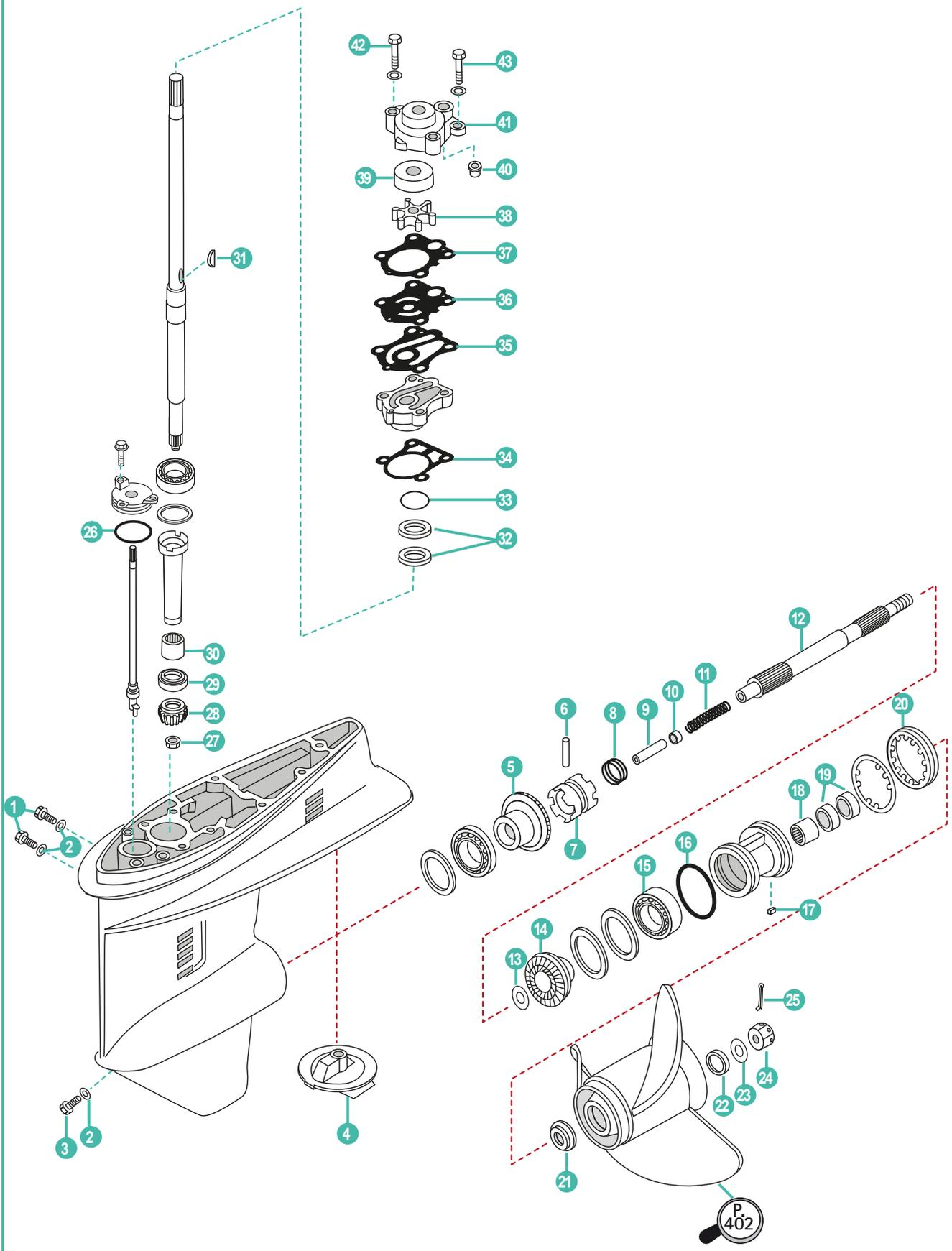



	REF	OEM				
1	REC90340-08002	90340-08014	TORNILLO	BOLT	VITE	VIS
2	REC90430-08020	90430-08020	JUNTA	GASKET	GUARNIZIONE	JOINT
3	REC688-45341-00	688-45341-00	TAPÓN DRENAJE	PLUG	TAPPO	BOUCHON DE VIDANGE
4	CM664-45371-01	664-45371-01	ÁNODO	ANODE	ANODO	ANODE
5	REC6H4-45560-00	6H4-45560-00	PIÑÓN MARCHA AVANTE	POSITIVE GEAR ASSY	PIGNONE MARCIA AVANTI	PIGNON DE MARCHÉ AVANT
6	REC90250-06023	90250-06023	PASADOR	PIN	SPINOTTO	PIN
7	REC663-45631-00	663-45631-01	DESPLAZABLE	CLUTCH	SCORREVOLE	CRABOT
8	REC663-45633-00	663-45633-00	ARO	SPING	O-RING	JOINT TORIQUE
9	REC676-45635-00	676-45635-00	PIVOTE	PIN	SPINOTTO	PIVOT
10	REC663-45634-00	663-45634-00	CASQUILLO	SLIDE	BOCCOLA	DOUILLE
11	REC90501-16M01	90501-16M01	MUELLE	SPRING	MOLLA	RESSORT
12	REC679-45611-00	679-45611-01	EJE HÉLICE	SHAFT PROPELLER	ASSE ELICA	ARBRE D'HELICE
13	REC90201-22429	90201-22429	ARANDELA	WASHER	RONDELLA	RONDELLE
14	REC6H4-45570-00	6H4-45571-00	PIÑÓN MARCHA ATRÁS	REVERSE GEAR	PIGNONE MARCIA INDIETRO	PIGNON MARCHÉ ARRIÈRE
15	REC93306-00702	93306-00702	RODAMIENTO BOLAS	BEARING	CUSCINETTO	ROULEMENT
16	REC93210-66M98	93210-66M98	ARO	O-RING	O-RING	JOINT TORIQUE
17	REC90282-04010	90282-04010	CHAVETA	KEY	CHIAVETTA	CLAVETTE
18	REC93317-22204	93317-22204	COJINETE AGUJAS	CILINDRIC BEARING	CUSCINETTO	ROULEMENT
19	REC93101-22067	93101-22067	RETÉN ACEITE	OIL SEAL	PARAOLIO	JOINT SPI
20	REC697-45384-00	697-45384-00	TUERCA	NUT	DADO	ÉCROU
21	REC663-45987-00	663-45987-02	ESPACIADOR	SPACER	DISTANZIALE	ENTRETOISE
22	REC670-45997-00	670-45997-02	ESPACIADOR	SPACER	DISTANZIALE	ENTRETOISE
23	REC92990-16200	92990-16200	ARANDELA	WASHER	RONDELLA	RONDELLE
24	REC90171-16011	90171-16011	TUERCA	NUT	DADO	ÉCROU D'HELICE
25	REC91490-30030	91490-30030	PASADOR	PIN COTTER	SPINOTTO	CLAVETTE
26	REC93210-49046	93210-49046	ARO PLATO	O-RING	O-RING	JOINT TORIQUE
27	REC90170-12138	90170-12138	TUERCA	NUT	DADO	ÉCROU
28	REC6H4-45551-00	6H4-45551-00	PIÑÓN ATAQUE	INITIATIVE GEAR	MARCIA INIZIATIVA	PIGNON D'ATTAQUE
29	REC663-45552-00	663-45552-00	COJINETE (-1998)	BEARING (-1998)	CUSCINETTO (-1998)	ROULEMENT (-1998)
30	REC93315-32224	93315-32224	RODAMIENTO AGUJAS	BEARING	CUSCINETTO	ROULEMENT
31	REC90280-03024	90280-03024	CHAVETA	KEY	CHIAVETTA	CLAVETTE
32	REC93101-23070	93101-23070	RETÉN ACEITE	OIL SEAL	PARAOLIO	JOINT SPI
33	REC93210-41042	93210-41042	ARO, BASE BOMBA	O-RING	O-RING	JOINT TORIQUE
34	REC663-44316-A0	663-44316-A0	JUNTA BASE	GASKET	GUARNIZIONE	JOINT
35	REC663-44324-A0	663-44324-A0	JUNTA	GASKET	GUARNIZIONE	JOINT
36	REC663-44323-00	663-44323-00	TAPA	OUTTER PLATE	TAPPO	PLAQUE DE POMPE À EAU
37	REC663-44315-A0	663-44315-A0	JUNTA	GASKET	GUARNIZIONE	JOINT
38	REC6H4-44352-02	6H4-44352-02	IMPULSOR	IMPELLER	GIRANTE	TURBINE
39	REC663-44322-00	663-44322-00	CASQUILLO	INSERT CARTRIDGE	BOCCOLA	INSERT DE POMPE À EAU
40	REC663-44366-00	663-44366-00	RETÉN	SEAL	TENUTA	JOINT SPI
41	REC663-44311-02	663-44311-02	CUERPO BOMBA AGUA	HOUSING WATER P.	CORPO POMPA ACQUA	CORPS DE POMPE À EAU
42	REC97095-08045	97395-08045	TORNILLO	BOLT	VITE	VIS
43	REC97095-08055	97395-08055	TORNILLO	BOLT	VITE	VIS

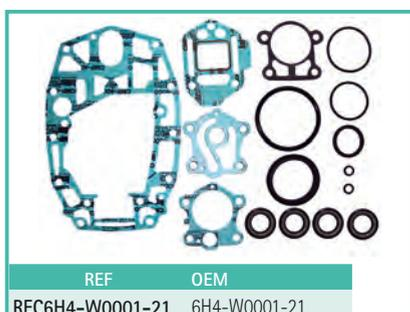

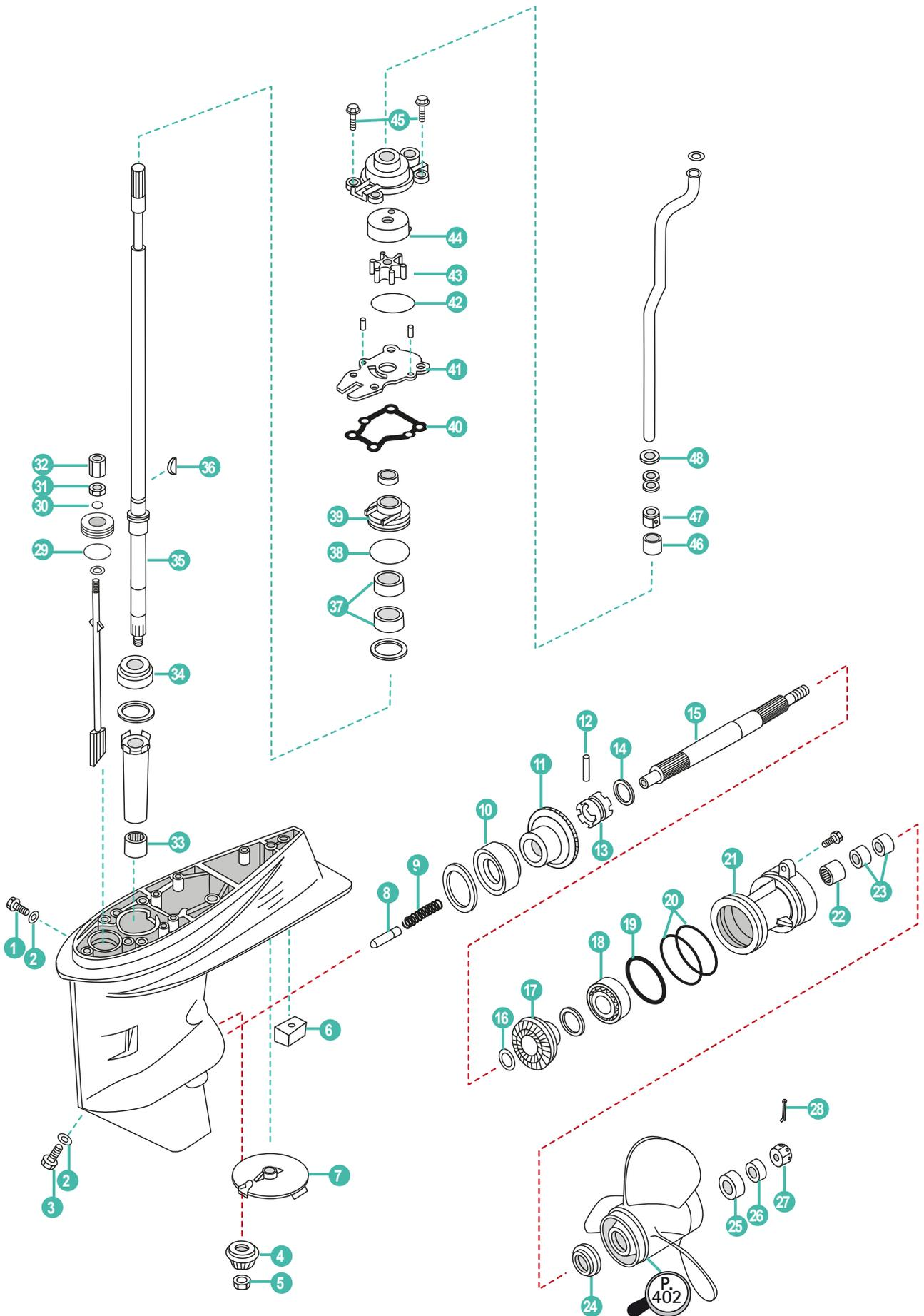

	REF	OEM				
1	REC90340-08002	90340-08002	TAPÓN	PLUG	TAPPO	BOUCHON DE VIDANGE
2	REC90430-08020	90430-08020	JUNTA	GASKET	GUARNIZIONE	JOINT
3	REC688-45341-00	688-45341-10	TAPÓN	PLUG	TAPPO	BOUCHON DE VIDANGE
4	REC66T-45551-00	66T-45551-00	PIÑÓN ATAQUE	INITIATIVE GEAR	MARCIA INIZIATIVA	PIGNON D'ATTAQUE
5	REC90170-12138	90170-12138	TUERCA	NUT	DADO	ECROU
6	CM67C-45251-00	67C-45251-00	ÁNODO	ANODE	ANODO	ANODE
7	CM664-45371-01	664-45371-01	ÁNODO DERIVA	TAB-TRIM	ANODO	ANODE
8	REC66T-45635-00	66T-45635-00	BULÓN	PLUNGER	BULLONE	BOULON
9	PAT40-04050002	90501-15M01	RESORTE	SPRING	MOLLA	RESSORT
10	REC93332-00003	93332-00003	RODAMIENTO	BEARING	CUSCINETTO	ROULEMENT
11	REC66T-45560-00	66T-45560-01	PIÑÓN MARCHA AVANTE	POSITIVE GEAR ASSY	PIGNONE MARCIA AVANTI	PIGNON DE MARCHÉ AVANT
12	REC90250-06023	90250-06023	PASADOR	PIN	SPINOTTO	PIN
13	REC66T-45631-00	66T-45631-00	SELECTOR	CLUTCH, DOG	SELETTORE	CRABOT
14	REC663-45633-00	663-45633-00	ANILLO	RING	O-RING	JOINT TORIQUE
15	REC66T-45611-00	66T-45611-00	EJE HÉLICE	SHAFT	ASSE ELICA	ARBRE D'HELICE
16	REC90201-22429	90201-22429	ARANDELA	WASHER	RONDELLA	RONDELLE
17	REC66T-45571-00	66T-45571-00	PIÑÓN MARCHA ATRÁS	REVERSE GEAR	PIGNONE MARCIA INDIETRO	PIGNON MARCHÉ ARRIÈRE
18	REC93306-001U1	93306-001U1	RODAMIENTO	BEARING	CUSCINETTO	ROULEMENT
19	REC93210-69MG6	93210-69MG6	ANILLO TÓRICO	O-RING	O-RING	JOINT TORIQUE
20	REC93210-74MG5	93210-74MG5	ANILLO TÓRICO	O-RING	O-RING	JOINT TORIQUE
21	REC63D-45361-02-4D	63D-45361-02-4D	DIÁVOLO	CAP	COP. CASSA INGRANAGGI	DIABOLO
22	REC93317-22204	93317-22204	RODAMIENTO	BEARING	CUSCINETTO	ROULEMENT
23	REC93101-22M00	93101-22M00	RETÉN	OIL SEAL	PARAOLIO	JOINT SPI
24	REC663-45987-00	663-45987-02	ESPACIADOR	SPACER	DISTANZIALE	ENTRETOISE
25	REC66T-45997-00	66T-45997-00	ESPACIADOR	SPACER	DISTANZIALE	ENTRETOISE
26	REC90389-22M01	90389-22M01	CASQUILLO GRUESO	BUSH	BOCCOLA	RONDELLE D'HELICE
27	REC90171-16011	90171-16011	TUERCA HÉLICE	NUT, CASTLE	DADO	ECROU D'HELICE
28	REC91490-30025	91490-30025	PASADOR ALETAS	PIN	SPINOTTO	CLAVETTE
29	REC93210-33MG4	93210-33MG4	ARILLO TÓRICO	O-RING	O-RING	JOINT TORIQUE
30	REC93210-06ME6	93210-06ME6	ARILLO TÓRICO	O-RING	O-RING	JOINT TORIQUE
31	REC95380-06700	95380-06700	TUERCA	NUT	DADO	ECROU
32	REC61N-44146-00	61N-44146-00	CONECTOR	CONNECTOR	RACCORDO	CONNECTEUR
33	REC93315-32224	93315-32224	RODAMIENTO	BEARING	CUSCINETTO	ROULEMENT
34	REC93332-00001	93332-00001	RODAMIENTO	BEARING	CUSCINETTO	ROULEMENT
35	REC66T-45501-01	66T-45501-01	EJE VERTICAL S	DRIVE SHAFT ASSY S	ASSE VERTICALE S	ARBRE VERTICAL S
	REC66T-45501-10	66T-45501-11	EJE VERTICAL L	DRIVE SHAFT ASSY L	ASSE VERTICALE L	ARBRE VERTICAL L
36	REC90280-03M03	90280-03M03	CHAVETA	KEY	CHIAVETTA	CLAVETTE
37	REC93101-22M60	93101-22M60	RETÉN	OIL SEAL	PARAOLIO	JOINT SPI
38	REC93210-48MG8	93210-48MG8	ARILLO TÓRICO	O-RING	O-RING	JOINT TORIQUE
39	REC63D-44341-00	63D-44341-00	CUERPO	HOUSING	CORPO	LOGEMENT
40	REC63D-44316-00	63D-44316-00	JUNTA	GASKET, WATER PUMP	GUARNIZIONE	JOINT
41	REC66T-44323-00	66T-44323-00	PLATO	OUTTER PLATE	PIASTRA	PLAQUE DE POMPE À EAU
42	REC93210-59MG7	93210-59MG7	ARILLO TÓRICO	O-RING	O-RING	JOINT TORIQUE
43	REC6H4-44352-02	6H4-44352-02	TURBINA	IMPELLER	GIRANTE	TURBINE
44	REC63D-44322-00	63D-44322-00	CASQUILLO	INSERT	BOCCOLA	INSERT DE POMPE À EAU
45	REC90119-08M15	90119-08M15	TORNILLO	BOLT	VITE	BOULON
46	REC663-44366-00	663-44366-00	CASQUILLO	DAMPER	BOCCOLA	DOUILLE
47	REC63D-44312-00	63D-44312-00	TAPA	COVER	COPERCHIO	BAGUE
48	REC90430-12072	90430-12072	JUNTA	GASKET	GUARNIZIONE	JOINT

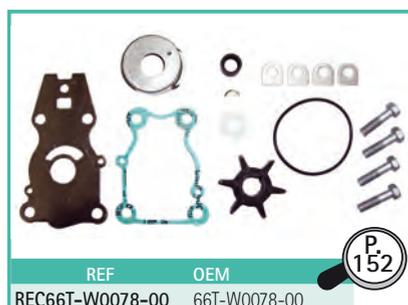
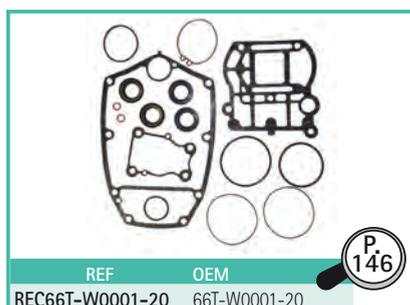

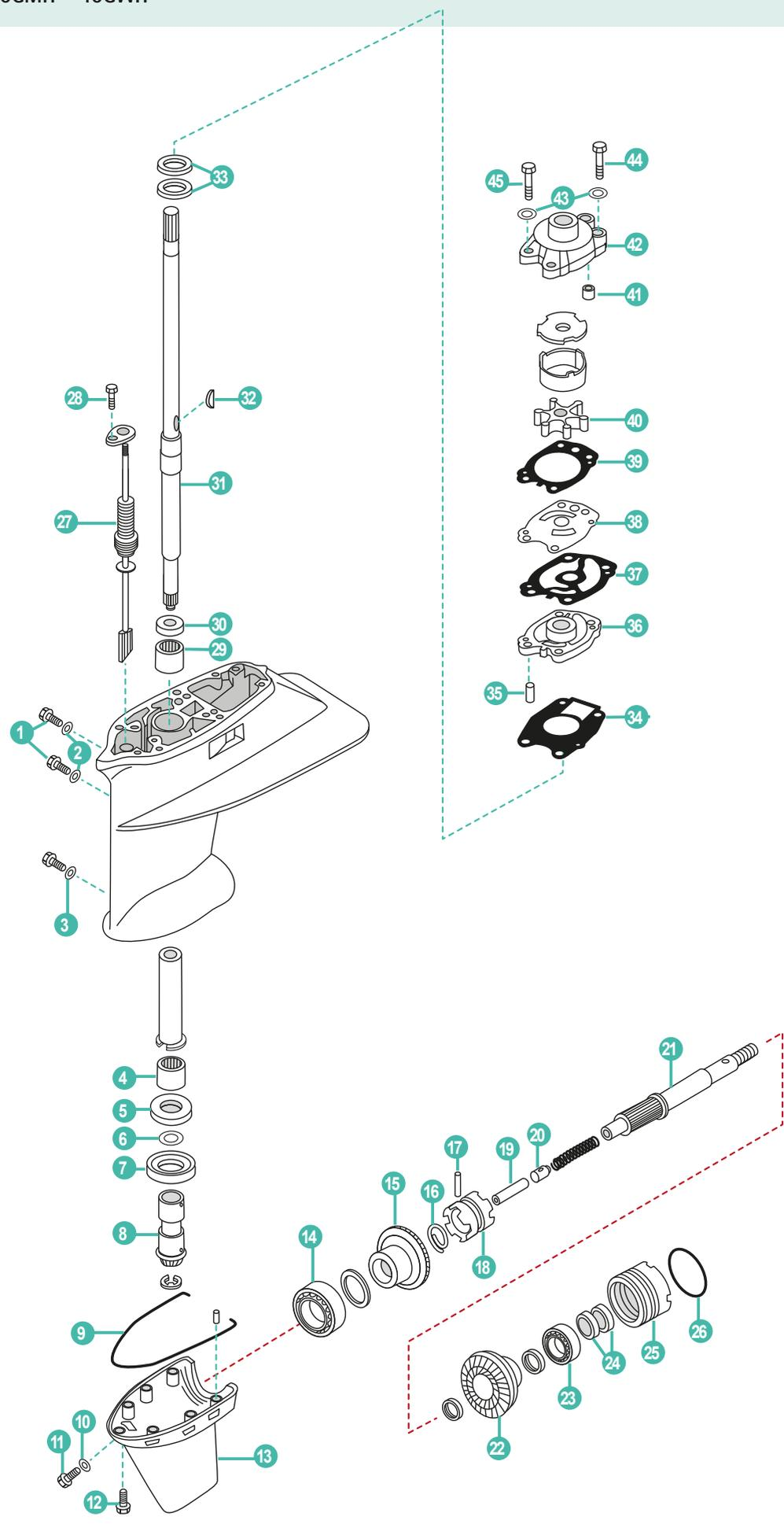

	REF	OEM				
1	REC90340-08002	90340-08002	TORNILLO, DRENAJE	BOLT DRAIN	VITE	BOUCHON DE VIDANGE
2	REC90430-08020	90430-08020	JUNTA	GASKET	GUARNIZIONE	JOINT
3	REC90430-06M03	90430-06M03	JUNTA	GASKET	GUARNIZIONE	JOINT
4	REC93315-324U1	93315-324U1	COJINETE DE RODILLOS	BEARING	CUSCINETTO	ROULEMENT
5	REC93342-624U0	93342-624U0	COJINETE CON RODAMIENTOS	BEARING	CUSCINETTO	ROULEMENT
6	REC676-45587-00	676-45587-00-70	GRUESO	SHIM (t:0.070mm)	SPESSORE	CALE (0.070mm)
	REC676-45587-00-75	676-45587-00-75	GRUESO	SHIM (t:0.075mm)	SPESSORE	CALE (0.075mm)
	REC676-45587-00-80	676-45587-00-80	GRUESO	SHIM (t:0.080mm)	SPESSORE	CALE (0.080mm)
7	REC93390-000U0	93390-000U0	COJINETE DE RODILLOS	BEARING	CUSCINETTO	ROULEMENT
8	REC6F5-45551-00	6F5-45551-00	PIÑÓN	PINION (13T)	PIGNONE	PIGON (13D)
9	REC676-45314-00	676-45314-00	SELLO DE FUNDA INFERIOR	SEAL	BOCCOLA COPERCHIO INFERIORE	JOINT DE CARTER INFERIEUR
10	REC90430-08020	90430-08020	JUNTA	GASKET	GUARNIZIONE	JOINT
11	REC688-45341-00	688-45341-10	TAPÓN, DREN	BOLT DRAIN	TAPPO	BOUCHON DE VIDANGE
12	REC90105-06M01	90105-06M01	TORNILLO	BOLT	VITE	VIS
13	REC6F5-45312-00-4D	6F5-45312-01-4D	FUNDA INFERIOR	CASING	COPERCHIO INFERIORE	CARTER INFERIEUR
14	REC93332-000U0	93332-000U0	COJINETE	BEARING	CUSCINETTO	ROULEMENT
15	REC6F5-45560-00	6F5-45560-00	PIÑÓN MARCHA AVANTE	POSITIVE GEAR ASSY	PIGNONE MARCIA AVANTI	PIGNON DE MARCHÉ AVANT
16	REC663-45633-00	663-45633-00	ANILLO DE PASADOR	RING, CROSS PIN	O-RING	JOINT TORIQUE
17	REC90250-06023	90250-06023	PASADOR CILÍNDRICO	PIN, STRAIGHT	SPINOTTO	PIN
18	REC663-45631-00	663-45631-01	EMBRAGUE DE GARRA	CLUTCH DOG	GIUNTO A DENTI FRONTALI	CRABOT
19	REC676-45635-00	676-45635-00	ÉMBOLO DE CAMBIO	PLUNGER SHIFT	CAMBIO PISTONE	PISTON
20	REC663-45634-00	663-45634-00	DESILIZADOR, CAMBIO	SLIDE SHIFT	SCORREVOLE	DOUILLE
21	REC6F6-45611-00	6F6-45611-00	EJE PROPULSOR	SHAFT PROPELLER	ASSE GIRANTE	ARBRE D'HELICE
22	REC6F5-45570-00	6F5-45570-00	ENGRANAJE COMPL. 2.	GEAR	INGRANAGGIO	PIGNON
23	REC93306-204Y7	93306-20401	COJINETE (B6204)	BEARING	CUSCINETTO	ROULEMENT
24	REC93101-20048	93101-20048	SELLO ACEITE	OIL SEAL	PARAOLIO	JOINT SPI
25	REC676-45361-00	676-45361-01-94	FUNDA INFERIOR	CAP LOWER CASING	COPERCHIO INFERIORE	DIABOLO
26	REC93210-57M00	93210-57M00	ARO TÓRICO	O-RING	O-RING	JOINT TORIQUE
27	REC650-44147-00	650-44147-00	HULE DE VARILLA	BOOT, SHIFT ROD	AVVIO, BARRA DI SPOSTAMENTO	GUIDE
28	PAGB/T5783-M6X10	97095-06010	PERNO	BOLT	VITE	VIS
29	REC93315-217U0	93315-217U0	COJINETE DE RODILLOS	BEARING	CUSCINETTO	ROULEMENT
30	REC676-45533-00	676-45533-00	ARANDELA DE EMPUJE AXIAL	WASHER	RONDELLA	RONDELLE
31	REC676-45501-10	676-45501-10	EJE DE MANDO COMPL.	DRIVE SHAFT	ASSE VERTICALE	ARBRE VERTICAL
32	REC90280-04M00	90280-04M00	CUNA WOODRUFF	KEY WOODRUFF	CHIAVE WOODRUFF	CLAVETTE
33	REC93101-22M00	93101-22M00	SELLO ACEITE	OIL SEAL	PARAOLIO	JOINT SPI
34	REC676-44316-A1	676-44316-A1	EMPAQUE	GASKET	GUARNIZIONE	JOINT
35	PAF25-04000007	93604-08062	PASADOR DE CLAVIJA	PIN, DOWEL	SPINOTTO	CLAVETTE
36	REC676-44341-00	676-44341-94	CAJA BOMBA DE AGUA	HOUSING WATER PUMP	ALLOGGIAMENTO POMPA ACQUA	BASE DE POMPE À EAU
37	REC676-44324-A0	676-44324-A1	EMPAQUE	GASKET	GUARNIZIONE	JOINT
38	REC676-44323-00-40	676-44323-40	PLACA EXTERIOR DEL CARTUCHO	PLATE	PIASTRA	PLAQUE DE POMPE À EAU
39	REC676-44315-00	676-44315-A1	EMPAQUE	GASKET	GUARNIZIONE	JOINT
40	REC6F5-44352-00	6F5-44352-00	IMPULSOR	IMPELLER	GIRANTE	TURBINE
41	REC663-44366-00	663-44366-00	GOMA DEL SELLO DE AGUA	DAMPER WATER SEAL	BOCCOLA GOMMA ACQUA	BAGUE
42	REC676-44311-00	676-44311-00	CAJA BOMBA AGUA	HOUSING WATER PUMP	ALLOGGIAMENTO POMPA ACQUA	CORPS DE POMPE À EAU
43	PAGB/T97.1-8	92995-08600	ARANDELA	WASHER	RONDELLA	RONDELLE
44	REC97095-08055	97095-08055	PERNO	BOLT	VITE	VIS
45	REC97095-08045	97095-08045	PERNO	BOLT	VITE	VIS



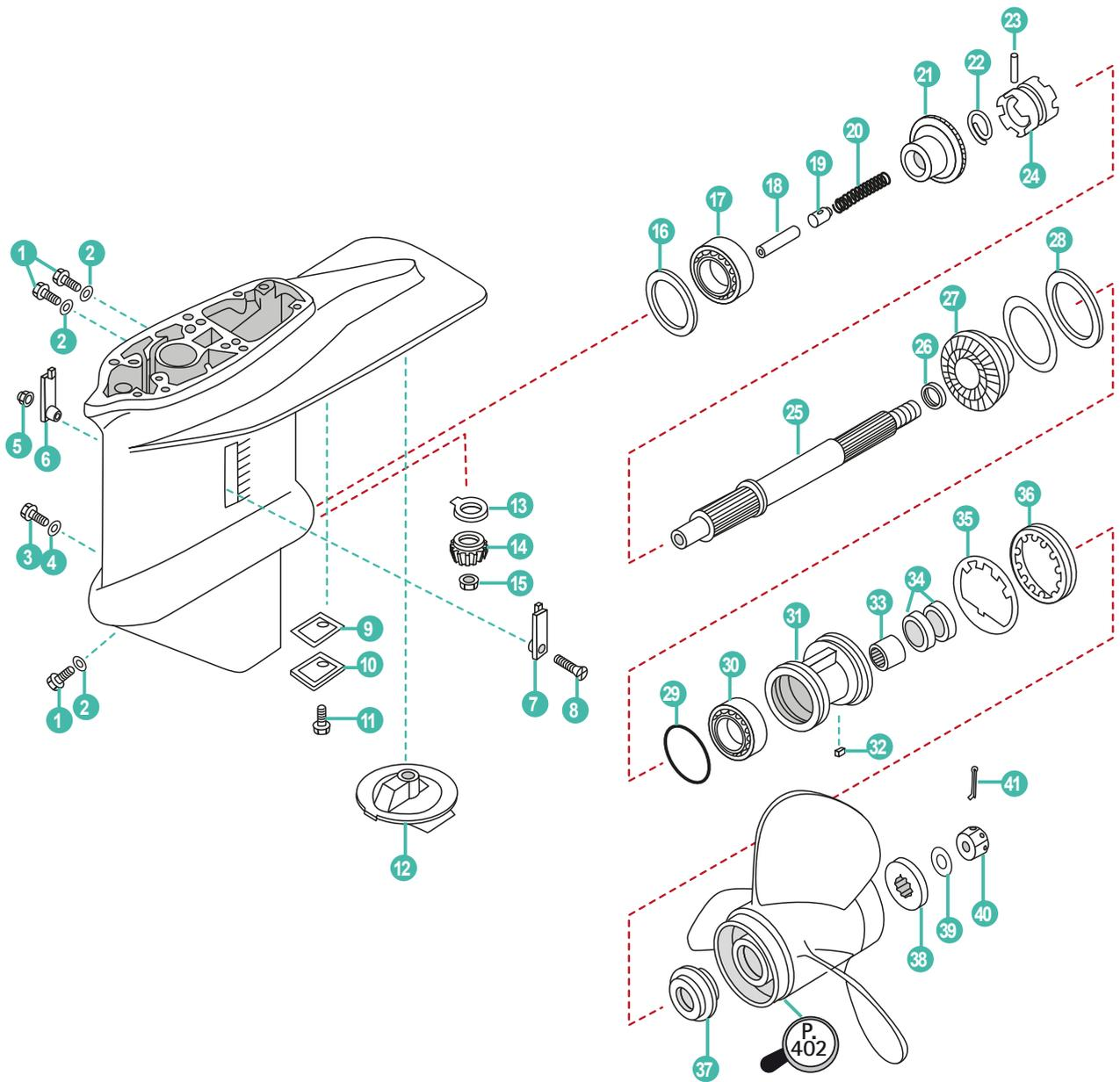

	REF	OEM				
1	REC90340-08002	90340-08M14	TORNILLO NIVEL ACEITE	VENT PLUG	VITE LIVELLO OLIO	BOUCHON DE VIDANGE
2	REC90430-08020	90430-08020	ARANDELA	WASHER	RONDELLA	RONDELLE
3	REC90149-06M00	90149-06M00	TORNILLO DRENAJE	DRAIN SCREW	VITE DRENAGGIO	BOUCHON DE VIDANGE
4	REC90430-06M03	90430-06M03	JUNTA	GASKET	GUARNIZIONE	JOINT
5	PAGB/T889.1-M5		TUERCA	NUT	DADO	ÉCROU
6	REC688-45215-02	688-45215-02	TAPA ENTRADA DE AGUA	WATER SCREEN	COPERCHIO RAFFREDDAMENTO	GRILLE D'ENTREE D'EAU
7	REC688-45214-02	688-45214-02	TAPA ENTRADA DE AGUA	WATER SCREEN	COPERCHIO RAFFREDDAMENTO	GRILLE D'ENTREE D'EAU
8	PAGB/T820-M5X30		TORNILLO	SCREW	VITE	VIS
9	REC679-45315-A1	679-45315-A1	JUNTA	GASKET	GUARNIZIONE	JOINT
10	REC679-45321-02	679-45321-02	PLACA	PLATE	PIASTRA	PLAQUE
11	PAGB/T818-M6X16	98580-06016	TORNILLO	SCREW	VITE	VIS
12	TEN01101	679-45371-00	ÁNODO	ANODE	ANODO	ANODE
13	REC663-45552-00	663-45552-00	COJINETE PLANO	BEARING	CUSCINETTO	ROULEMENT
14	REC6H9-45551-00	6H9-45551-00	PIÑÓN ATAQUE	INITIATIVE GEAR	MARCIA INIZIATIVA	PIGNON D'ATTAQUE
15	REC90170-12138	90170-012138	TUERCA	NUT	DADO	ÉCROU
	PAT40-04000004-1	663-45567-01-10	GRUESO (0.10mm)	SHIM (0.10mm)	SPESSORE (0.10mm)	CALE (0.10mm)
16	PAT40-04000004-2	663-45567-01-12	GRUESO (0.12mm)	SHIM (0.12mm)	SPESSORE (0.12mm)	CALE (0.12mm)
	PAT40-04000004-3	663-45567-01-15	GRUESO (0.15mm)	SHIM (0.15mm)	SPESSORE (0.15mm)	CALE (0.15mm)
	PAT40-04000004-5	663-45567-01-30	GRUESO (0.30mm)	SHIM (0.30mm)	SPESSORE (0.30mm)	CALE (0.30mm)
17	REC93332-00003	93332-00003	COJINETE	BEARING	CUSCINETTO	ROULEMENT
18	REC676-45635-00	676-45635-00	ÉMBOLO DE CAMBIO	PIVOT	PERNO	PIVOT
19	REC663-45634-00	663-45634-00	DESILIZADOR DE CAMBIO	CLUTCH DOG	TRAINABILE CAMBIO	PISTON
20	REC90501-16M01	90501-16M01	RESORTE DE COMPRESIÓN	SPRING	MOLLA	RESSORT
21	REC679-45560-00	679-45560-00	PIÑÓN MARCHA AVANTE	POSITIVE GEAR ASSY	PIGNONE MARCIA AVANTI	PIGNON DE MARCHE AVANT
22	REC663-45633-00	663-45633-00	ANILLO DEL PASADOR	ANNULAR SPRING, CLUTCH	ANELLO	RESSORT
23	REC90250-06023	90250-06023	PASADOR	PIN	FERMO	GOUPILLE
24	REC663-45631-00	663-45631-01	EMBRAGUE DE GARRA	CLUCH DOG	SELETTORE	CRABOT
25	REC679-45611-00	679-45611-01	EJE PROPULSOR	PROPELLER SHAFT	ASSE ELICA	ARBRE D'HELICE
26	REC90201-22429	90201-22429	ARANDELA PLANA	WASHER	RONDELLA	RONDELLE
27	REC679-45571-00	679-45571-00	PIÑÓN MARCHA ATRÁS	REVERSE GEAR	PIGNONE MARCIA INDIETRO	PIGNON MARCHE ARRIÈRE
28	REC663-45576-00	663-45576-00	ARANDELA DE EMPUJE	PUSH WASHER	RONDELLA DI SPINTA	RONDELLE D'APPUI
29	REC93210-66M98	93210-66M98	O-RING	O-RING	O-RING	JOINT TORIQUE
30	REC93306-00702	93306-00702	COJINETE	BEARING	CUSCINETTO	ROULEMENT
31	REC679-45331-00	679-45331-00-94	DIABOLO	DIABOLO	DIABOLO	DIABOLO
32	REC90282-04010	90282-04010	CHAVETA	KEY	CHIAVETTE	CLAVETTE
33	REC93317-22204	93317-22204	COJINETE	BEARING	CUSCINETTO	ROULEMENT
34	REC93101-22067	93101-22067	RETÉN DE ACEITE	SEAL OIL	PAROLIO	JOINT SPI
35	REC90214-48M03	90214-48M03	ARANDELA	WASHER	RONDELLA	RONDELLE
36	REC697-45384-00	697-45384-00	TUERCA	NUT	DADO	ÉCROU
37	REC663-45987-00	663-45987-00	ESPACIADOR	DISTANCE WASHER	DISTANZIALE	ENTRETOISE
38	REC66T-45997-00	66T-45997-00	ESPACIADOR	DISTANCE WASHER	DISTANZIALE	ENTRETOISE
39	REC90389-22M01	90389-22M01	ARANDELA	WASHER	RONDELLA	RONDELLE
40	REC90171-16011	90171-16011	TUERCA	NUT	DADO	ÉCROU D'HELICE
41	REC91490-30025	91490-30025	CLIP	CLIP	CLIP	GOUPILLE

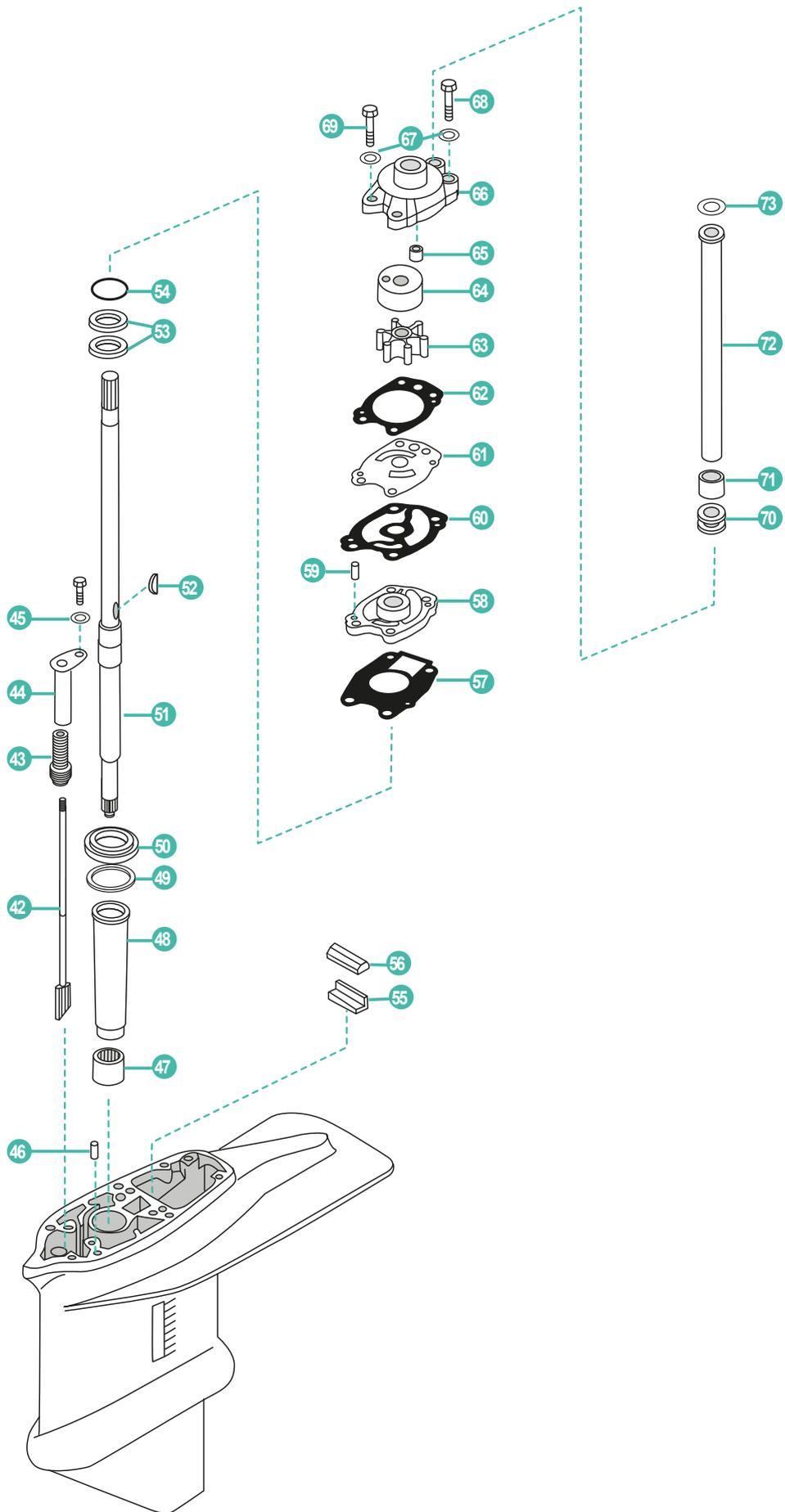



	REF	OEM				
42	REC679-44150-10	679-44150-10	EJE SELECTOR L	SHAFT SELECTOR L	ASSE SELETTORE L	ARBRE SELECTEUR L
	REC679-44150-00	679-44150-00	EJE SELECTOR S	SHAFT SELECTOR S	ASSE SELETTORE S	ARBRE SELECTEUR S
43	REC650-44147-00	650-44147-00	FUELLE EJE	BOOT, SHIFT ROD	BOOT, SHIFT ROD	SOUFFLET
44	REC679-44152-00	679-44152-00	BUJE LEVE DE CAMBIO	HUBE GEAR LEVE	MOZZO LEVA CAMBIO	LEVIER DE VITESSE
45	PAGB/T97.1-6	92990-06600	ARANDELA PLANA	WASHER	RONDELLA	RONDELLE
46	REC93606-12019	93606-12019	PIN CENTRADOR	PIN DOWEL	SPINOTTO DI CENTRAGGIO	CLAVETTE DE CENTRAGE
47	REC93315-32224	93315-32224	COJINETE	BEARING	CUSCINETTO	ROULEMENT
48	REC679-45536-00	679-45536-00	CAMISA EJE TRASMISION	BUSHING NYLON	CAMICIA ASSE TRASMISSIONE	AXE TRANSMISSION
	PAT40-04000003-1	663-45587-01-10	GRUESO (0.10mm)	SHIM (0.10mm)	SPESSORE (0.10mm)	CALE (0.10mm)
	PAT40-04000003-2	663-45587-01-12	GRUESO (0.12mm)	SHIM (0.12mm)	SPESSORE (0.12mm)	CALE (0.12mm)
	PAT40-04000003-3	663-45587-01-15	GRUESO (0.15mm)	SHIM (0.15mm)	SPESSORE (0.15mm)	CALE (0.15mm)
49	PAT40-04000003-4	663-45587-01-18	GRUESO (0.18mm)	SHIM (0.18mm)	SPESSORE (0.18mm)	CALE (0.18mm)
	PAT40-04000003-5	663-45587-01-30	GRUESO (0.30mm)	SHIM (0.30mm)	SPESSORE (0.30mm)	CALE (0.30mm)
	PAT40-04000003-6	663-45587-01-40	GRUESO (0.40mm)	SHIM (0.40mm)	SPESSORE (0.40mm)	CALE (0.40mm)
	PAT40-04000003-7	663-45587-01-50	GRUESO (0.50mm)	SHIM (0.50mm)	SPESSORE (0.50mm)	CALE (0.50mm)
50	PAT40-04000027	93332-00079	COJINETE	BEARING	CUSCINETTO	ROULEMENT
51	REC679-45501-10	679-45501-10	EJE L	SHAFT L	ASSE L	ARBRE L
52	REC90280-04M00	90280-04M00	CHAVETA	KEY	CHIAVETTA	CLAVETTE
53	REC93101-22067	93101-22067	RETÉN DE ACEITE	SEAL OIL	PARAOILIO	JOINT SPI
54	REC93210-41042	93210-41042	TÓRICA	O-RING	O-RING	JOINT TORIQUE
55	REC663-45376-00	663-45376-00	GUIA RETEN	GUIDE RUB. SEAL	GUIDA PARAOILIO	GUIDE
56	REC663-45375-00	663-45375-00	GOMA SELLADORA	SEALING RUBBER	ANELLO SIGILLANTE	JOINT CAOUTCHOUC
57	REC679-44316-A0	679-44316-A0	JUNTA	GASKET	GUARNIZIONE	JOINT
58	REC679-44341-00	679-44341-00-94	CAJA BOMBA DE AGUA	WATER PUMP HOUSING	SCATOLA POMPA ACQUA	BASE DE POMPE À EAU
59	PAF25-04000007	93604-08062	PASADOR	PIN	FERMO	GOUPILLE
60	REC676-44324-A0	676-44324-A0	JUNTA	GASKET	GUARNIZIONE	JOINT
61	REC676-44323-00-40	676-44323-00	PLACA EXTERIOR DEL CARTUCHO	OUTER PLATE	PLACCA ESTERNA	PLAQUE DE POMPE À EAU
62	REC676-44315-00	676-44315-A0	JUNTA	GASKET	GUARNIZIONE	JOINT
63	REC6F5-44352-00	6F5-44352-002	IMPULSOR	IMPELLER	GIRANTE	TURBINE
64	REC676-44322-00	676-44322-00	CASQUILLO INOX	CARTRIDGE INSERT	BOCCOLA	INSERT DE POMPE À EAU
65	REC663-44366-00	663-44366-00	RETEN TUBO AGUA	DAMPER, WATER SEAL	GHIERA	JOINT DE TUBE D'EAU
66	REC676-44311-00	676-44311-00	CAJA BOMBA DE AGUA	WATER PUMP HOUSING	SCATOLA POMPA ACQUA	CORPS DE POMPE À EAU
67	PAGB/T97.1-8	92990-08600	ARANDELA PLANA	WASHER	RONDELLA	RONDELLE
68	REC97095-08055	97095-08055	PERNO	BOLT	BOULONE	BOULON
69	REC97095-08045	97095-08045	PERNO	BOLT	BOULONE	BOULON
70	PAT40-02000002	663-44367-00	GOMA DEL SELLO DE AGUA	GUIDE BUSHING, WATER PIPE	GUARNIZIONE	GUIDE DE PIPE D'EAU
71	REC90430-12072	90430-12072	JUNTA	GASKET	GUARNIZIONE	JOINT
72	REC676-44361-00	676-44361-00	TUBO S	TUBE S	TUBO S	TUBE S
	REC676-44361-10	676-44361-10	TUBO L	TUBE L	TUBO L	TUBE L
73	PAF25-02000019	90202-12060	GOMA DEL SELLO DE AGUA	GUIDE BUSHING, WATER PIPE	GUARNIZIONE	GUIDE DE PIPE D'EAU



REF  
 REC80W90U3  
 REC80W90U6  
 RECGREU1  
 RECGREU12

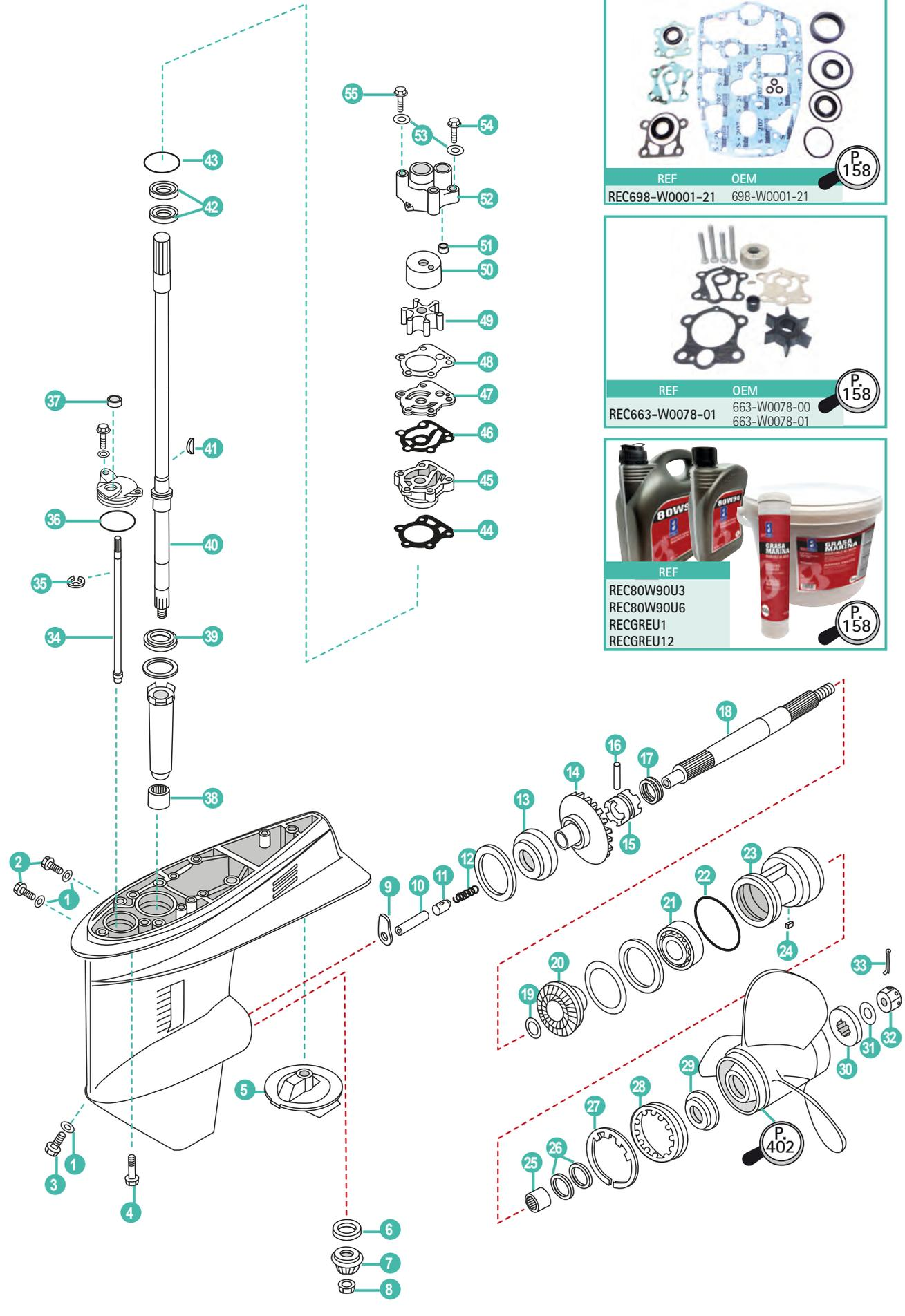

	REF	OEM				
1	REC90430-08020	90430-08020	JUNTA	GASKET	GUARNIZIONE	JOINT
2	REC90340-08002	90340-08002	TORNILLO	STRAIGHT SCREW	VITE	VIS
3	REC688-45341-00	688-45341-10	TAPÓN, DREN	PLUG, DRAIN	TAPPO	BOUCHON DE VIDANGE
4	REC97075-10040	97075-10040	PERNO	BOLT	PERNO	BOULON
5	TEN01101	679-45371-00	ÁNODO	ANODE	ANODO	ANODE
6	REC663-45552-00	663-45552-00	COJINETE PLANO	BEARING, PLAIN	CUSCINETTO PIATO	ROULEMENT
7	REC697-45551-00	697-45551-00	PIÑÓN ATAQUE	INITIATIVE GEAR	MARCIA INIZIATIVA	PIGNON D'ATTAQUE
8	REC90170-12138	90170-12138	TUERCA	NUT	DADO	ÉCROU
9	REC663-44151-00	663-44151-00	LEVA DE CAMBIO	CAM SHIFT	ALBERO	CAME
10	REC688-45635-00	688-45635-00	PLUNGER, SHIFT	ÉMBOLO DE CAMBIO	CAMBIO PISTONE	PISTON
11	REC663-45634-00	663-45634-00	DESILIZADOR CAMBIO	SLIDE, SHIFT	SCORREVOLE	DOUILLE
12	REC90501-16233	90501-16233	RESORTE DE COMPRESIÓN	SPRING	MOLLA	RESSORT
13	REC93332-00003	93332-00003	COJINETE	BEARING	CUSCINETTO	ROULEMENT
14	REC697-45560-00	697-45560-00	PIÑÓN MARCHA AVANTE	POSITIVE GEAR ASSY	PIGNONE MARCIA AVANTI	PIGNON DE MARCHÉ AVANT
15	REC663-45631-00	663-45631-01	EMBRAGUE DE GARRA	CLUTCH, DOG	GIUNTO A DENTI FRONTALE	CRABOT
16	REC90250-06023	90250-06023	PASADOR CILÍNDRICO	PIN, STRAIGHT	SPINOTTO	PIN
17	REC663-45633-00	663-45633-00	ANILLO DE PASADOR	RING, CROSS PIN	O-RING	JOINT TORIQUE
18	REC697-45611-00	697-45611-00	EJE PROPULSOR	SHAFT PROPELLER	ASSE	ARBRE D'HELICE
19	REC90201-22429	90201-22429	ARANDELA PLANA	WASHER, PLATE	RONDELLA	RONDELLE
20	REC697-45570-00	697-45571-00	PIÑÓN MARCHA ATRÁS	REVERSE GEAR	PIGNONE MARCIA INDIETRO	PIGNON MARCHÉ ARRIÈRE
21	REC93306-00702	93306-00702	COJINETE	BEARING	CUSCINETTO	ROULEMENT
22	REC93210-66M98	93210-66M98	ANILLO O	O- RING	O-RING	JOINT TORIQUE
23	REC663-45331-00-94	663-45331-00-94	CAJA DE COJINETE	HOUSING, BEARING	SEDE CUSCINETTO	DIABOLO
24	REC90282-04010	90282-04010	CHAVETA	KEY, STRAIGHT	CHIAVETTA	CLAVETTE
25	REC93317-22204	93317-22204	COJINETE	BEARING	CUSCINETTO	ROULEMENT
26	REC93101-22067	93101-22067	SELLO ACEITE	OIL SEAL	PARAOLIO	JOINT SPI
27	REC90214-48M03	90214-48M03	ARANDELA	WASHER	RONDELLA	RONDELLE
28	REC697-45384-00	697-45384-00	TUERCA	NUT	DADO	ÉCROU
29	REC663-45987-00	663-45987-02	ESPACIADOR	SPACER	DISTANZIALE	ENTRETOISE
30	REC670-45997-00	670-45997-02	ESPACIADOR	SPACER	DISTANZIALE	ENTRETOISE
31	REC92990-16200	92990-16200	ARANDELA PLANA	WASHER, PLAIN	RONDELLA	RONDELLE
32	REC90171-16011	90171-16011	TUERCA ENTALLADA	NUT, CASTLE	DADO	ÉCROU D'HELICE
33	REC91490-40030	91490-40025	CHAVETA	PIN, COTTER	CHIAVETTA	GOUPILLE
34	REC663-44144-01	663-44144-01	VARILLA DE CAMBIO	ROD, SHIFT	ASTICELLA	LEVIER DE VITESSE
35	REC99001-08600-00	99001-08600	CLIP	CLIP	CLIP	CLAVETTE
36	REC93210-49046	93210-49046	ANILLO	O-RING	O-RING	JOINT TORIQUE
37	REC93106-09014	93106-09014	RETÉN DE ACEITE	OIL SEAL	PARAOLIO	JOINT SPI
38	REC93315-32224	93315-32224	COJINETE DE RODILLOS	BEARING	CUSCINETTO	ROULEMENT
39	REC93332-00001	93332-00001	COJINETE	BEARING	CUSCINETTO	ROULEMENT
40	REC663-45510-01	663-45510-01	EJE DE MANDO	DRIVE SHAFT ASSY	ASSE VERTICALE	ARBRE VERTICAL
41	REC90280-03M03	90280-03M03	CHAVETA	KEY, WOODRUFF	CHIAVE	CLAVETTE
42	REC93101-23070	93101-23070	SELLO ACEITE	OIL SEAL	PARAOLIO	JOINT SPI
43	REC93210-41042	93210-41042	ANILLO O	O-RING	O-RING	JOINT TORIQUE
44	REC663-44316-A0	663-44316-A0	EMPAQUE	GASKET, WATER PUMP	GUARNIZIONE	JOINT DE POMPE À EAU
45	REC663-44311-02	663-44341-00	CAJA BOMBA	HOUSING, WATER PUMP	CORPO POMPA	BASE DE POMPE À EAU
46	REC663-44324-00	663-44324-A0	EMPAQUE	GASKET, CARTRIDGE	GUARNIZIONE	JOINT
47	REC663-44323-00	663-44323-00	PLACA EXTERIOR	OUTTER PLATE	PIASTRA EXT.	PLAQUE DE POMPE À EAU
48	REC663-44315-A0	663-44315-A0	EMAPAQUE	GASKET, WATER PUMP	GUARNIZIONE	JOINT
49	REC6H3-44352-00	697-44352-00	IMPULSOR	IMPELLER	GIRANTE	TURBINE
50	REC663-44322-00	663-44322-00	CARTUCHO	INSERT CARTRIDGE	CARTUCCIA	INSERT DE POMPE À EAU
51	REC663-44366-00	663-44366-00	GOMA SELLO	DAMPER, WATER SEAL	BOCCOLA GOMMA	BAGUE
52	REC663-44311-02	663-44311-02	CAJA BOMBA	HOUSING, WATER PUMP	CORPO POMPA	CORPS DE POMPE À EAU
53	PAGB/T97.1-8	92995-08600	ARANDELA	WASHER	RONDELLA	RONDELLE
54	REC97095-08045	97095-08045	PERNO	BOLT	VITE	VIS
55	REC97095-08055	97095-08055	PERNO	BOLT	VITE	VIS

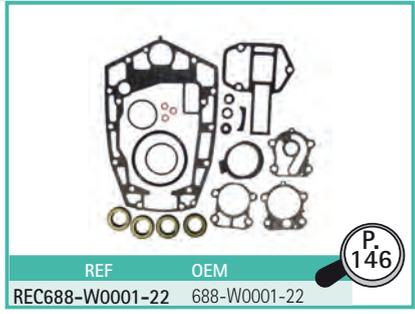
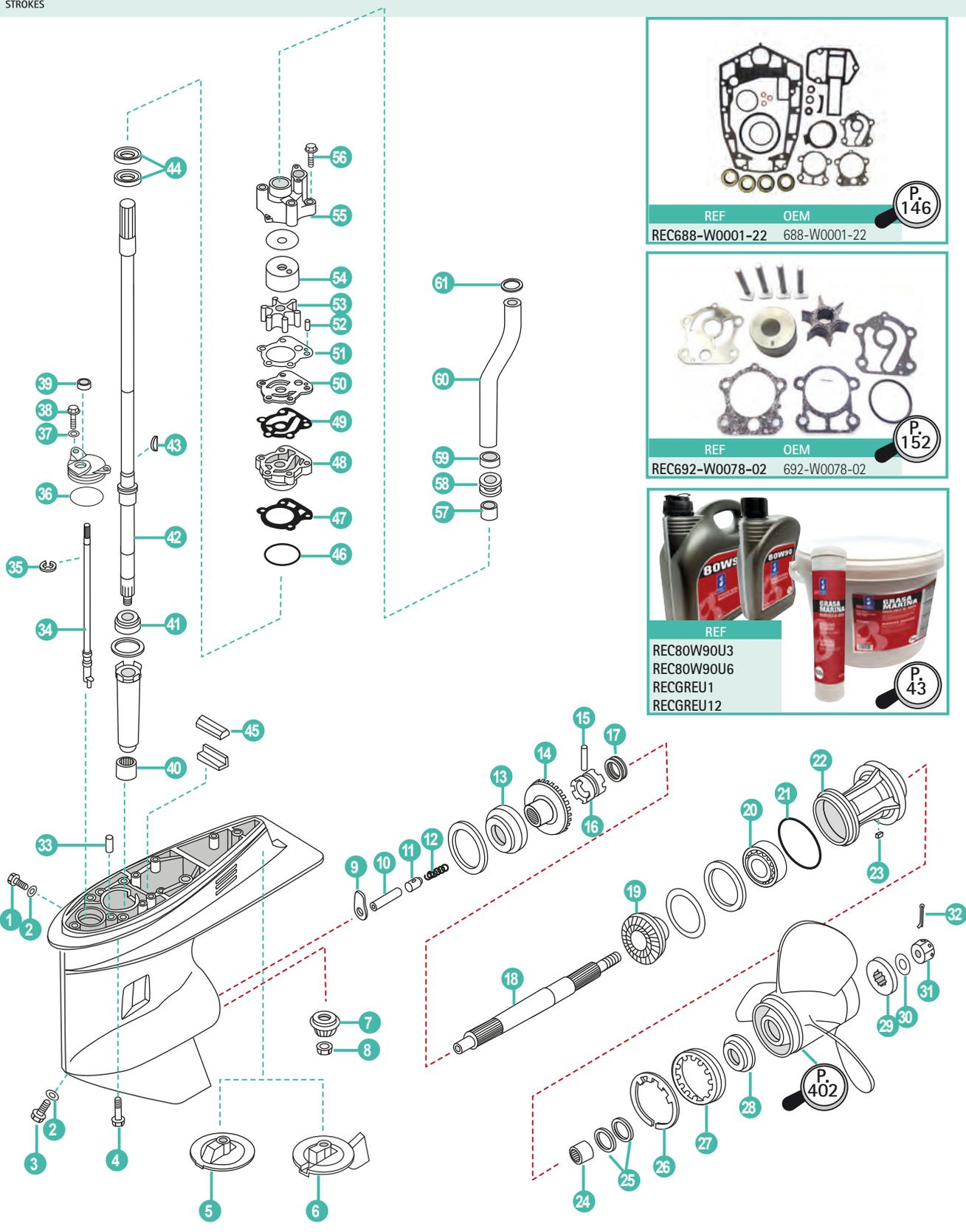

	REF	OEM				
	REC692-45300-16-8D	692-45300-14-4D	COLA COMPLETA L	LOWER UNIT ASSY L	PIEDE COMPLETO L	EMBASE COMPLETE L
1	REC90340-08002	90340-08002	TAPÓN	PLUG STRAIGHT SCREW	TAPPO	BOUCHON DE VIDANGE
2	REC90430-08020	90430-08020	JUNTA	GASKET	GUARNIZIONE	JOINT
3	REC688-45341-00	688-45341-10	TAPÓN	PLUG DRAIN	TAPPO	BOUCHON DE VIDANGE
4	REC97075-10040	97075-10040	TORNILLO	BOLT WITH WASHER	VITE	VIS
5	TEN01153	6E5-45371-10	ÁNODO TIMÓN	TAB-TRIM	ANODO	ANODE

	REF	OEM				
6	CM688-45371-02	688-45371-02	ÁNODO TIMÓN STD.	TAB-TRIM STD	ANODO STD	ANODE
7	REC688-45551-00	688-45551-01	PIÑÓN ATAQUE	INITIATIVE GEAR	MARCIA INIZIATIVA	PIGNON D'ATTAQUE
8	REC90170-16M01	90170-16M01	TUERCA	NUT	DADO	ECROU
9	REC663-44151-00	663-44151-00	LEVA	CAM, SHIFT	LEVA	CAME
10	REC688-45635-00	688-45635-00	BULÓN	PLUNGER, SHIFT	BULLONE	BOULON
11	REC688-45634-00	688-45634-00	EMPUJADOR	SLIDE, SHIFT	SCORREVOLE	DOUILLE
12	REC90501-16233	90501-16233	MUELLE	SPRING, COMPRESSION	MOLLA	RESSORT
13	REC93332-000W7	93332-000W7	RODAMIENTO	BEARING	CUSCINETTO	ROULEMENT
14	REC688-45560-00	688-45560-00	PIÑÓN MARCHA AVANTE	POSITIVE GEAR ASSY	PIGNONE MARCIA AVANTI	PIGNON DE MARCHÉ AVANT
15	REC90250-07M02	90250-07M02	PASADOR	PIN, STRAIGHT	SPINOTTO	PIN
16	REC688-45631-00	688-45631-01	DESPLAZABLE	CLUTCH, DOG	GIUNTO A DENTI FRONTALE	CRABOT
17	REC688-45633-00	688-45633-00	ARO METÁLICO	RING, CROSS PIN	O-RING	JOINT TORIQUE
18	REC688-45611-00	688-45611-00	EJE HÉLICE	SHAFT, PROPELLER	ASSE ELICA	ARBRE D'HELICE
19	REC688-45570-00	688-45571-01	PIÑÓN MARCHA ATRÁS	REVERSE GEAR	PIGNONE MARCIA INDIETRO	PIGNON MARCHÉ ARRIÈRE
20	REC93306-207U0	93306-207U0	RODAMIENTO	BEARING	CUSCINETTO	ROULEMENT
21	REC93210-85M97	93210-85M97	ARO TÓRICO	O-RING	O-RING	JOINT TORIQUE
22	REC688-45331-00-94	688-45331-00-94	DIÁBOLO	HOUSING, BEARING	COP. CASSA INGRANAGGI	DIABOLO
23	REC90282-04010	90282-04010	CHAVETA	KEY, STRAIGHT	CHIAVETTA	CLAVETTE
24	REC93317-325U0	93317-325U0	RODAMIENTO	BEARING	CUSCINETTO	ROULEMENT
25	REC93101-25M03	93101-25M03	RETÉN	OIL SEAL	PARAOLIO	JOINT SPI
26	REC688-45383-01	688-45383-02	ARANDELA CIERRE	WASHER, CLAW	RONDELLA CHIUSURA	RONDELLE
27	REC688-45384-00	688-45384-00	TUERCA	NUT	DADO	ECROU
28	REC688-45987-00	688-45987-01	SEPARADOR	SPACER	DISTANZIALE	ENTRETOISE
29	REC67F-45997-00	67F-45997-00	SEPARADOR	SPACER	DISTANZIALE	ENTRETOISE
30	REC90389-25M00	90389-25M00	CASQUILLO	BUSH	BOCCOLA	RONDELLE
31	REC90171-16011	90171-16011	TUERCA	NUT, CASTLE	DADO	ECROU D'HELICE
32	REC91490-40030	91490-40025	PASADOR ALETAS	PIN, COTTER	SPINOTTO	GOUPILLE
33	REC93606-12019	93606-12019	PASADOR	PIN, DOWEL	SPINOTTO	PIN
34	REC663-44144-01	663-44144-01	EJE SELECTOR	ROD, SHIFT	ASSE SELETTORE	ARBRE DE VITESSE
35	REC99001-08600-00	99001-08600	CERCLIP	CIRCLIP	CIRCLIP	CIRCLIP
36	REC93210-49046	93210-49046	ARO TÓRICO	O-RING	O-RING	JOINT TORIQUE
37	PAGB/T5783-M6X16	92995-06600	ARANDELA	WASHER	RONDELLA	RONDELLE
38	PAGB/T97.1-6	97095-06016	TORNILLO	BOLT	VITE	VIS
39	REC93106-09014	93106-09014	RETÉN	OIL SEAL	PARAOLIO	JOINT SPI
40	REC93315-325V1	93315-325V1	RODAMIENTO	BEARING	CUSCINETTO	ROULEMENT
41	REC93332-000U3	93332-000U3	RODAMIENTO	BEARING	CUSCINETTO	ROULEMENT
42	REC688-45501-11	688-45501-11	EJE VERTICAL	DRIVE SHAFT COMP.	ASSE VERTICALE	ARBRE VERTICAL
43	REC90280-04M04	90280-04M04	CHAVETA	KEY, WOODRUFF	CHIAVETTA	CLAVETTE
44	REC93101-25M03	93101-25M03	RETÉN	OIL SEAL	PARAOLIO	JOINT SPI
45	REC688-45375-00	688-45375-00	RETÉN DAMPER	DAMPER WASHER	PARAOLIO DAMPER	JOINT SILENT BLOC
46	REC93210-46044	93210-46044	ARO TÓRICO	O-RING	O-RING	JOINT TORIQUE
47	REC688-44316-00	688-44316-A0	JUNTA	GASKET WATER PUMP	GUARNIZIONE	JOINT DE POMPE À EAU
48	REC688-44341-01	688-44341-01-94	TAPA INF. BOMBA AGUA	HOUSING, WATER PUMP	CORPO INF. POMPA ACQUA	BASE DE POMPE À EAU
49	REC688-44324-00	688-44324-A0	JUNTA	GASKET, CARTRIDGE	GUARNIZIONE	JOINT
50	REC688-44323-00	688-44323-40	PLATO	OUTTER PLATE, CARTRIDGE	PIASTRA	PLAQUE DE POMPE À EAU
51	REC688-44315-00	688-44315-A0	JUNTA	GASKET, WATER PUMP	GUARNIZIONE	JOINT
52	PAF25-04000007	93604-10M03	CENTRADOR	PIN, DOWEL	SPINOTTO	PIN
53	REC688-44352-03	688-44352-03	TURBINA	IMPELLER	GIRANTE	TURBINE
54	REC688-44322-00	688-44322-00	CASQUILLO INOX.	INSERT, CARTRIDGE	BOCCOLA INOX.	INSERT DE POMPE À EAU
55	REC688-44311-01	688-44311-01	CUERPO BOMBA AGUA	HOUSING, WATER PUMP	CORPO POMPA ACQUA	CORPS DE POMPE À EAU
56	REC90119-08M13	90119-08M13	TORNILLO	BOLT WITH WASHER	VITE	VIS
57	REC663-44366-00	663-44366-00	CASQUILLO GOMA	DAMPER, WATER SEAL	BOCCOLA GOMMA	BAGUE
58	PAT40-02000002	663-44367-00	GOMA DEL SELLO DE AGUA	GUIDE BUSHING, WATER PIPE	GU	GUIDE DE PIPE D'EAU
59	REC90430-12072	90430-12072	JUNTA	GASKET	GUARNIZIONE	JOINT
60	REC688-44361-10	688-44361-10	TUBO DE AGUA L	WATER TUBE L	TUBO ACQUA L	TUBE D'EAU L
61	PAF25-02000019	90202-12060	ARANDELA	WASHER	RONDELLA	RONDELLE

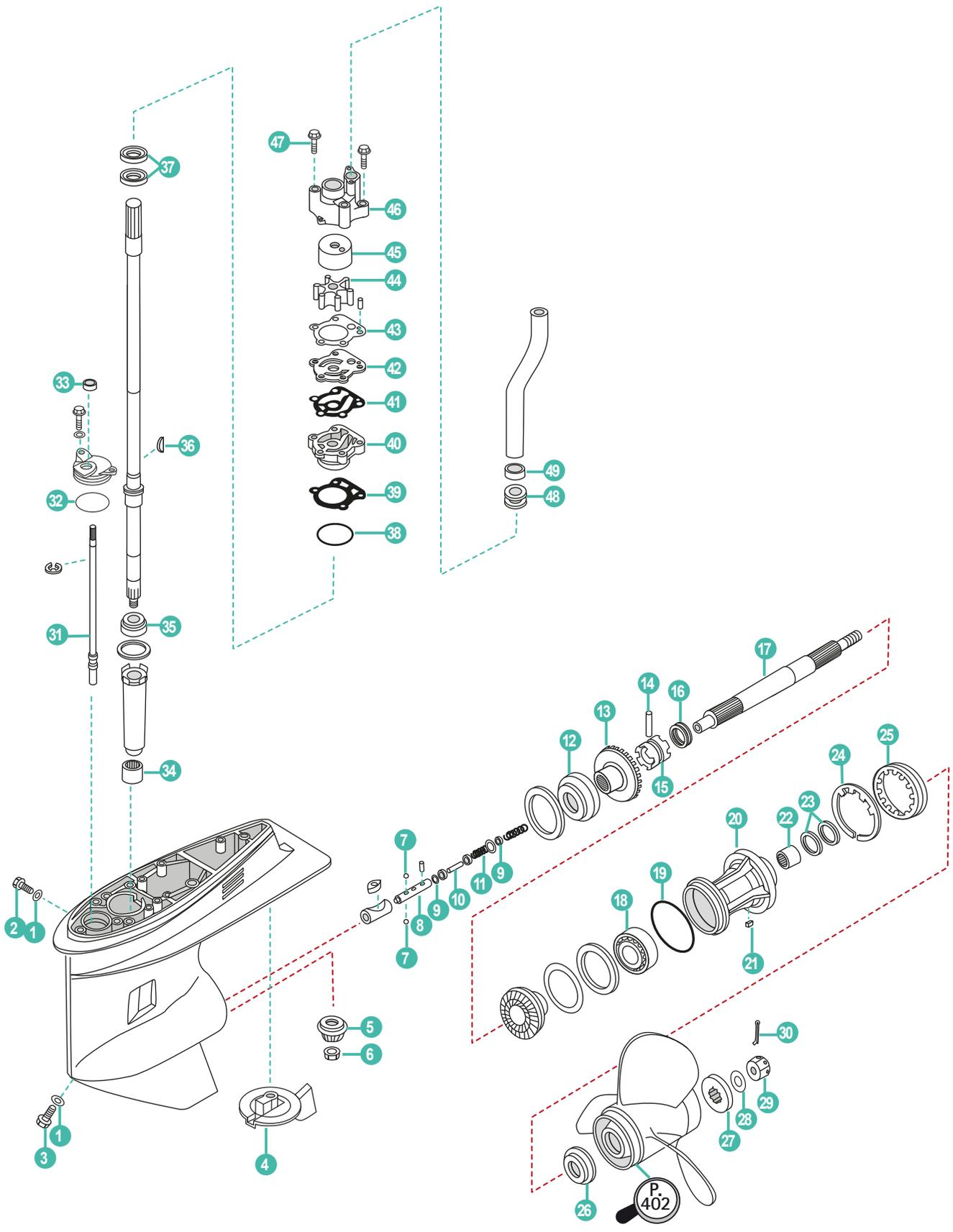

	REF	OEM				
1	REC90430-08020	90430-08020-00	JUNTA	GASKET	GUARNIZIONE	JOINT
2	REC90340-08002	90340-08002	TAPÓN	PLUG	TAPPO	BOUCHON DE VIDANGE
3	REC688-45341-00	688-45341-00-00	TAPÓN	PLUG	TAPPO	BOUCHON DE VIDANGE
4	CM688-45371-02	688-45371-02-00	ÁNODO	ANODE	ANODO	ANODE
5	REC688-45551-00	688-45551-01-00	PIÑÓN ATAQUE	INITIATIVE GEAR	MARCIA INIZIATIVA	PIGNON D'ATTAQUE
6	REC90170-16M01	90170-16M01-00	TUERCA	NUT	DADO	ECROU
7	REC93503-16003	93503-16003	ESFERA	BALL	SFERA	BILLE
8	REC6H1-45634-02	6H1-45634-02	DESPLAZABLE	SLIDE, SHIFT	SCORREVOLE	DOUILLE
9	REC90183-02M03	90183-02M03	TUERCA	NUT	DADO	ECROU
10	REC6H1-45668-00	6H1-45668-00	EJE	SHAFT	ASSE	ARBRE
11	REC90501-12M48	90501-12M48	RESORTE	SPRING	MOLLA	RESSORT
12	REC93332-000W7	93332-000W7-00	RODAMIENTO	BEARING	CUSCINETTO	ROULEMENT
13	REC688-45560-00	688-45560-00-00	PIÑÓN MARCHA AVANTE	POSITIVE GEAR ASSY	PIGNONE MARCIA AVANTI	PIGNON DE MARCHÉ AVANT
14	REC90250-07M02	90250-07M02-00	PASADOR	PIN	SPINOTTO	CLAVETTE
15	REC6H1-45631-01	6H1-45631-01-00	SELECTOR	CLUTCH	SELETTORE	CRABOT
16	REC688-45633-00	688-45633-00-00	MUELLE	SPRING	MOLLA	RESSORT
17	REC6H1-45611-00	6H1-45611-01-00	EJE HÉLICE	PROPELLER SHAFT	ASSE ELICA	ARBRE D'HELICE
18	REC93306-207U0	93306-207U0-00	RODAMIENTO	BEARING	CUSCINETTO	ROULEMENT
19	REC93210-85M97	93210-85M97-00	ARO TÓRICO	O-RING	O-RING	JOINT TORIQUE
20	REC688-45331-00-94	688-45331-00-94	DIABOLO	DIABOLO	DIABOLO	DIABOLO
21	REC90282-04010	90282-04010	CHAVETA	KEY	CHIAVETTA	CLAVETTE
22	REC93317-325U0	93317-325U0-00	RODAMIENTO	BEARING	CUSCINETTO	ROULEMENT
23	REC93101-25M03	93101-25M03-00	RETÉN	OIL SEAL	PARAOLIO	JOINT SPI
24	REC688-45383-01	688-45383-02-00	ARANDELA	WASHER	RONDELLA	RONDELLE
25	REC688-45384-00	688-45384-00-00	TUERCA	NUT	DADO	ECROU
26	REC688-45987-00	688-45987-01-00	ESPACIADOR	SPACER	DISTANZIALE	ENTRETOISE
27	REC688-45997-00	688-45997-01-00	ESPACIADOR	SPACER	DISTANZIALE	ENTRETOISE
28	REC90201-17M00	90201-17M00-00	ARANDELA	WASHER	RONDELLA	RONDELLE
29	REC90171-16011	90171-16011-00	TUERCA	NUT	DADO	ECROU D'HELICE
30	REC91490-40030	91490-40030-00	PASADOR	PIN	SPINOTTO	GOUPILLE
31	REC6H1-44144-00	6H1-44144-00	VARILLA CAMBIO	SHIFT ROD	ASSE SELETTORE	LEVIER DE VITESSE
32	REC93210-49046	93210-49046-00	ANILLO	O-RING	O-RING	JOINT TORIQUE
33	REC93106-09014	93106-09014-00	RETÉN	OIL SEAL	PARAOLIO	JOINT SPI
34	REC93315-325V1	93315-325V1-00	RODAMIENTO	BEARING	CUSCINETTO	ROULEMENT
35	REC93332-000U3	93332-000U3-00	RODAMIENTO	BEARING	CUSCINETTO	ROULEMENT
36	REC90280-04M04	90280-04M04-00	CHAVETA	KEY	CHIAVETTA	CLAVETTE
37	REC93101-25M03	93101-25M03-00	RETÉN	OIL SEAL	PARAOLIO	JOINT SPI
38	REC93210-46044	93210-46044-00	ANILLO, BASE	O-RING	O-RING	JOINT TORIQUE
39	REC688-44316-00	688-44316-A0-00	JUNTA, BASE	GASKET	GUARNIZIONE	JOINT
40	REC688-44341-01	688-44341-01-94	BASE, BOMBA AGUA	HOUSING WATER PUMP	BASE POMPA ACQUA	BASE DE POMPE À EAU
41	REC688-44324-00	688-44324-A0-00	JUNTA	GASKET	GUARNIZIONE	JOINT
42	REC688-44323-00	688-44323-00-00	PLATO	PLATE	PIASTRA	PLAQUE DE POMPE À EAU
43	REC688-44315-00	688-44315-A0-00	JUNTA	GASKET	GUARNIZIONE	JOINT
44	REC688-44352-03	688-44352-03-00	TURBINA	IMPELLER	GIRANTE	TURBINE
45	REC688-44322-00	688-44322-00-00	ACOPLAMIENTO INOX.	INSERT	BOCCOLA INOX.	INSERT DE POMPE À EAU
46	REC688-44311-01	688-44311-01-00	CUERPO BOMBA AGUA	HOUSING	CORPO POMA ACQUA	CORPS DE POMPE À EAU
47	REC97395-08070	97395-08070-00	TORNILLO	BOLT	VITE	VIS
48	REC663-44366-00	663-44366-00	RETÉN	SEAL	PARAOLIO	BAGUE
49	REC90430-12072	90430-12072-00	JUNTA	GASKET	GUARNIZIONE	JOINT

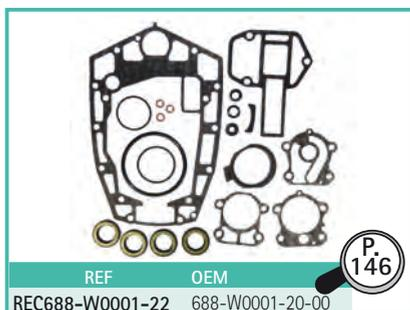

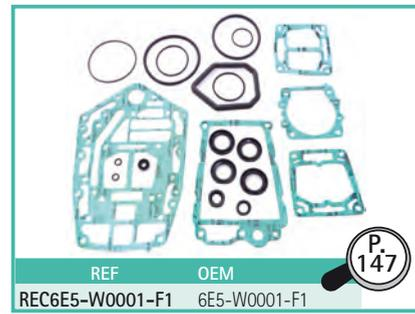
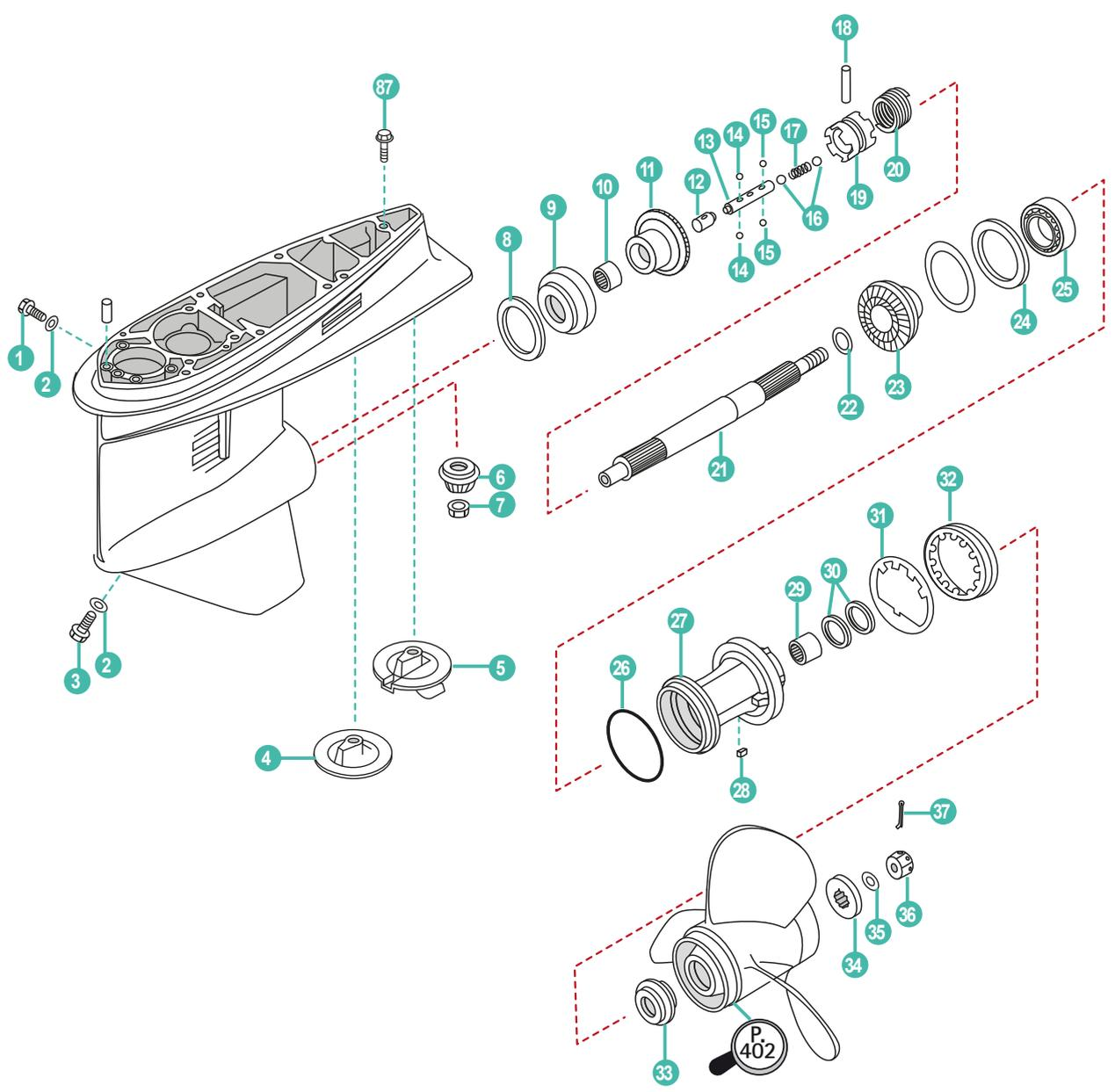



	REF	OEM				
	REC405-A20	6E5-45300-16-8D	COLA COMPLETA	LOWER UNIT ASSY	PIEDE COMPLETO	EMBASE COMPLETE
	REC405-A25	6E5-45300-26-8D	COLA COMPLETA	LOWER UNIT ASSY	PIEDE COMPLETO	EMBASE COMPLETE
1	REC90340-08002	90340-08M04	TAPÓN	PLUG, STRAIGHT SCREW	TAPPO	BOUCHON DE VIDANGE
2	REC90430-08020	90430-08020	JUNTA	GASKET	GUARNIZIONE	JOINT
3	REC688-45341-00	688-45341-00	TAPÓN	PLUG DRAIN	TAPPO	BOUCHON DE VIDANGE
4	REC6E5-45371-01	6E5-45371-01	ZINC HÉLICE ALU	TAB-TRIM	ZINCO ELICA ALLU.	ANODE
5	TEN01153	6E5-45371-10	ZINC HÉLICE INOX	TAB-TRIM	ZINCO ELICA INOX.	ANODE
6	REC6E5-45551-00	6E5-45551-02	PIÑÓN ATAQUE	INITIATIVE GEAR	MARCIA INIZIATIVA	PIGNON D'ATTAQUE
7	REC90170-16M01	90170-16M01	TUERCA	NUT	DADO	ECROU
8	REC6E5-45567-01	6E5-45567-01-60	KIT GRUESO	SHIM SET	KIT SPESSORE	KIT CALE
9	REC93332-000U7	93332-000U7	RODAMIENTO	BEARING	CUSCINETTO	ROULEMENT
10	REC93315-425U7	93315-425U7	RODAMIENTO	BEARING	CUSCINETTO	ROULEMENT
11	REC6E5-45560-00	6E5-45560-01	PIÑÓN MARCHA AVANTE	POSITIVE GEAR ASSY	PIGNONE MARCIA AVANTI	PIGNON DE MARCHE AVANT
12	REC6E5-45641-03	6E5-45641-02	BULÓN	SHIFTER	BULLONE	PISTON
13	REC6E5-45634-01	6E5-45634-01	PASADOR DESPLAZABLE	SLIDE, SHIFT	PASSANTE	DOUILLE
14	REC93507-32031	93507-32031	BOLA	BALL	BOLLA	BILLE
15	REC93503-16003	93503-16003	BOLA	BALL	BOLLA	BILLE
16	REC93511-32027	93511-32027	BOLA	BALL	BOLLA	BILLE
17	REC90501-16M37	90501-16M37	MUELLE	SPRING, COMPRESSION	MOLLA	RESSORT
18	REC90250-08M07	90250-08M07	PASADOR	PIN STRAIGHT	SPINOTTO	PIN
19	REC6E5-45631-00	6E5-45631-01	DESPLAZABLE	CLUTCH, DOG	SCORREVOLE	CRABOT
20	REC6E5-45633-01	6E5-45633-01	ARILLO METÁLICO	RING, CROSS PIN	O-RING	JOINT TORIQUE
21	REC6E5-45611-00	6E5-45611-01	EJE HÉLICE	SHAFT, PROPELLER	ASSE ELICA	ARBRE D'HELICE
22	REC90201-30M92	90201-30M92	ARANDELA	WASHER, PLATE	RONDELLA	RONDELLE
23	REC6E5-45570-00	6E5-45571-01	PIÑÓN MARCHA ATRÁS	REVERSE GEAR	PIGNONE MARCIA INDIETRO	PIGNON MARCHE ARRIÈRE
24	REC6E5-45576-00	6E5-45576-00	ARANDELA	WASHER, THURST	RONDELLA	RONDELLE
25	REC93306-208U0	93306-208U0	RODAMIENTO	BEARING	CUSCINETTO	ROULEMENT
26	REC93210-86M39	93210-86M39	ARO TÓRICO	O-RING	O-RING	JOINT TORIQUE
27	REC6E5-45332-00-94	6E5-45332-00-94	CUERPO COJINETE	HOUSING, BEARING	CUSCINETTO	DIABOLO
28	REC90282-04010	90282-04010	CHAVETA	KEY, STRAIGHT	CHIAVETTA	CLAVETTE
29	REC93315-430U8	93315-430U8	RODAMIENTO	BEARING	CUSCINETTO	ROULEMENT
30	REC93101-30M17	93101-30M17	RETÉN	OIL SEAL	PARAOLIO	JOINT SPI
31	REC688-45383-01	688-45383-02	ARANDELA	WASHER, CLAW	RONDELLA	RONDELLE
32	REC688-45384-00	688-45384-00	TUERCA	NUT	DADO	ECROU
33	REC6E5-45987-00	6E5-45987-01	SEPARADOR	SPACER	SPESSORE	ENTRETOISE
34	REC688-45997-00	688-45997-01	SEPARADOR	SPACER	SPESSORE	ENTRETOISE
35	REC92990-18200	92990-18200	ARANDELA	WASHER	RONDELLA	RONDELLE
36	REC90171-18M04	90171-18M04	TUERCA HÉLICE	NUT, CASTLE	DADO	ECROU D'HELICE
37	REC91490-40030	91490-40030	PASADOR ALETA	PIN, COTTER	SPINOTTO	GOUPILLE
38	PAT85-00000012	90105-10M00	TORNILLO	SCREW	VITE	VIS

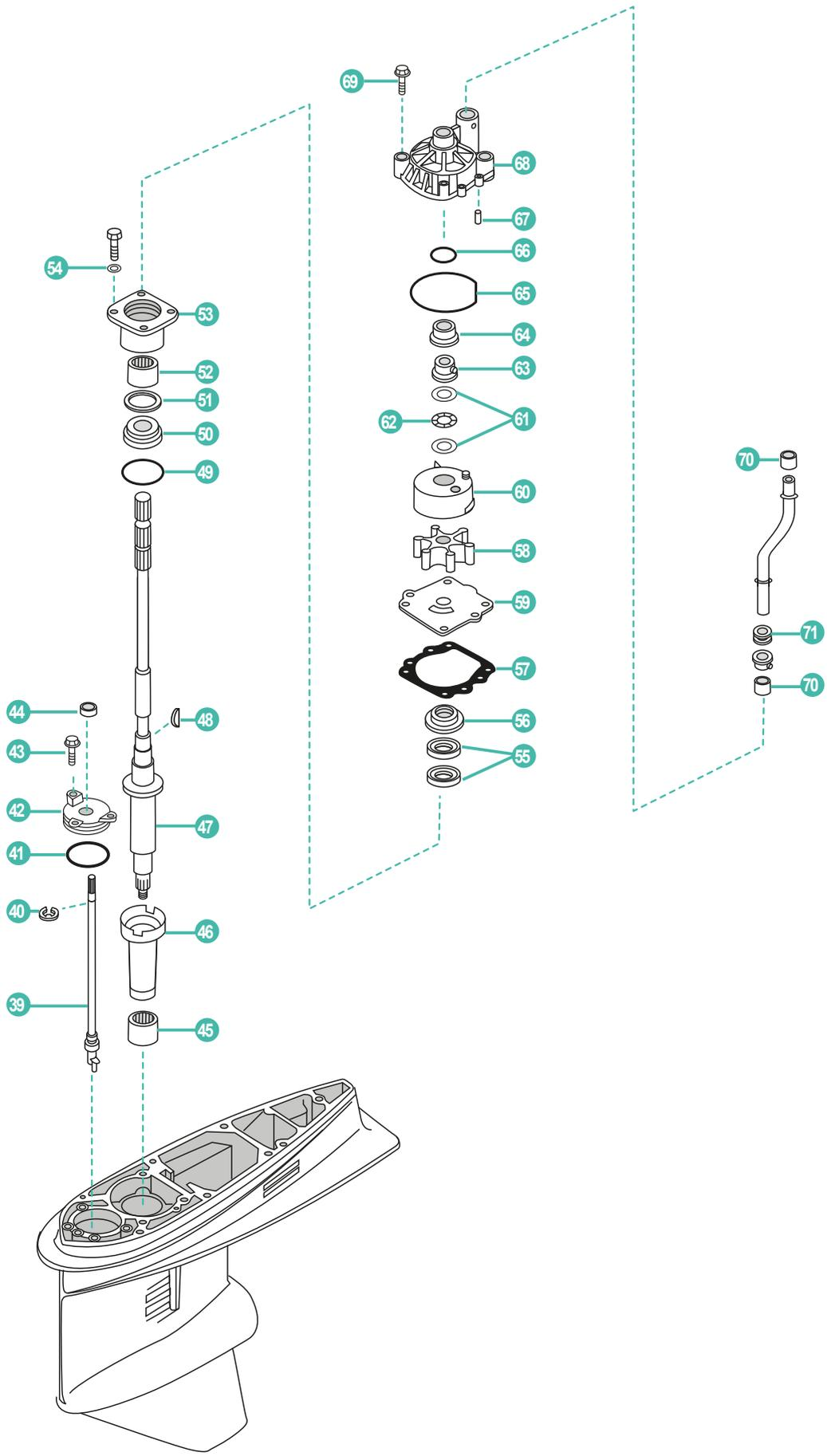

	REF	OEM				
39	REC6E5-44150-02	6E5-44150-01	EJE SELECTOR	SHIFT CAM ASSY.	ASSE SELETTORE	ARBRE SELECTEUR
40	REC99001-08600-00	99001-08600	CLIP	CLIP	CLIP	CLIP
41	REC93210-58677	93210-58144	ARO TÓRICO	O-RING	O-RING	JOINT TORIQUE
42	REC6E5-45321-00	6E5-45321-00	PLATO	PLATE	PIASTRA	PLAQUE
43	REC90119-06M10	90119-06M10	TORNILLO	BOLT WITH WASHER	VITE	VIS
44	REC93106-09014	93106-09014	RETÉN	OIL SEAL	PARAOLIO	JOINT SPI
45	REC93315-628U9	93315-628U9	RODAMIENTO	BEARING	CUSCINETTO	ROULEMENT
46	REC6E5-45536-00	6E5-45536-00	CAMISA	SLEEVE	CAMICIA	TUBE GUIDE
47	REC6E5-45501-01	6E5-45501-01	EJE VERTICAL S	DRIVE SHAFT COMP. S	ASSE VERTICALE S	ARBRE VERTICAL S
48	REC90280-04M05	90280-04M05	CHAVETA	KEY, WOODRUF	CHIAVETTA	CLAVETTE
49	REC93210-54534	93210-55M14	ARO TÓRICO	O-RING	O-RING	JOINT TORIQUE
50	REC93341-930V2	93341-930V2	RODAMIENTO	BEARING	CUSCINETTO	ROULEMENT
51	REC6E5-45587-01	6E5-45587-01	GRUESO	SHIM	SPESSORE	CALE
52	REC93317-330U2	93317-330U2	RODAMIENTO	BEARING	CUSCINETTO	ROULEMENT
53	REC6E5-45331-00-94	6E5-45331-00-94	CUERPO RODAMIENTO	HOUSING, BEARING	SEDE CUSCINETTO	PALIER DE ROULEMENT
54	PAGB/T97.1-8	92995-08600	ARANDELA	WASHER	RONDELLA	RONDELLE
55	REC93101-28M16	93101-28M16	RETÉN	OIL SEAL	PARAOLIO	JOINT SPI
56	REC6E5-45344-00	6E5-45344-00	TAPA RETÉN	COVER, OIL SEAL	COPERCHIO	COUVERCLE JOINT SPI
57	REC6E5-44315-A0	6E5-44315-A0	JUNTA BOMBA	GASKET, WATER PUMP	GUARNIZIONE	JOINT
58	REC6E5-44323-00-40	6E5-44323-00	PLATO	OUTTER PLATE, CARTRIDGE	PIASTRA	TURBINE
59	REC6E5-44352-01	6E5-44352-01	TURBINA	IMPELLER	GIRANTE	PLAQUE DE POMPE À EAU
60	REC61A-44322-02	61A-44322-02	CASQUILLO INOX	INSERT, CARTRIDGE	BOCCOLA INOX.	INSERT DE POMPE À EAU
61	REC90201-22M01	90201-22M01	ARANDELA	WASHER	RONDELLA	RONDELLE
62	REC90206-22M19	90206-22M19	ARANDELA	WASHER	RONDELLA	RONDELLE
63	REC61A-45538-00	61A-45538-00	ESPACIADOR	SPACER	DISTANZIALE	ENTRETOISE
64	REC61A-45527-00	61A-45527-00	CASQUILLO	COLLAR, DRIVE SHAFT	BOCCOLA	GUIDE
65	REC93210-86M38	93210-86M38	ARO TÓRICO	O-RING	O-RING	JOINT TORIQUE
66	REC93210-37160	93210-37160	ARO TÓRICO	O-RING	O-RING	JOINT TORIQUE
67	REC93606-12019	93606-12019	PIN CENTRADOR	PIN DOWEL	SPINOTTO	PIN
68	REC61A-44311-00	61A-44311-01	CUERPO BOMBA	HOUSING, WATER PUMP	CORPO POMPA	CORPS DE POMPE À EAU
69	REC90119-08M14	90119-08M14	TORNILLO	BOLT, WITH WASHER	VITE	VIS
70	REC6E5-44365-00	6E5-44365-00	CASQUILLO GOMA	DAMPER	BOCCOLA	BAGUE
71	REC6E5-44366-00	6E5-44366-00	CASQUILLO GOMA	DAMPER	BOCCOLA	BAGUE

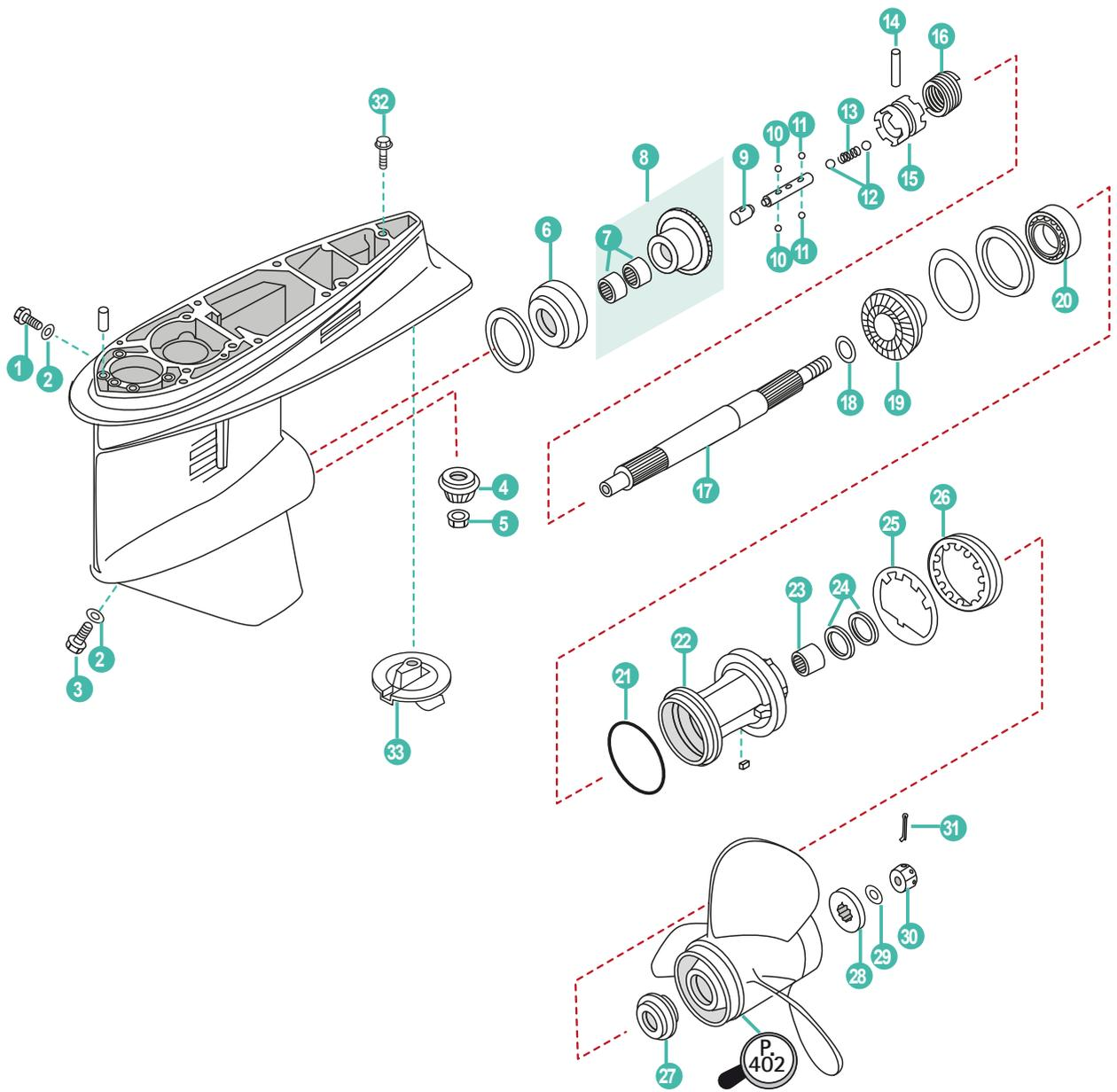

REF	OEM
REC6G5-W0078-A1	6G5-W0078-A1

P. 152

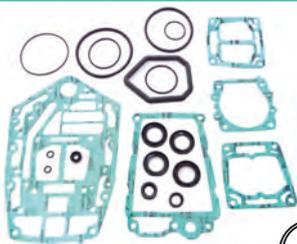

REF	OEM
REC6E5-W0001-F1	6E5-W0001-F1

P. 147



REF
REC80W90U3
REC80W90U6
RECGREU1
RECGREU12

P. 43

	REF	OEM				
	REC416-A20	64D-45300-02-8D	COLA COMPLETA 20"	LOWER UNIT ASSY 20"	PIEDE COMPLETO 20"	EMBASE COMPLETE 20"
	REC416-A25	64D-45300-22-8D	COLA COMPLETA 25"	LOWER UNIT ASSY 25"	PIEDE COMPLETO 25"	EMBASE COMPLETE 25"
1	REC90340-08002	90340-08002	TAPÓN	PLUG, STRAIGHT SCREW	TAPPO	BOUCHON DE VIDANGE
2	REC90430-08020	90430-08020	JUNTA	GASKET	GUARNIZIONE	JOINT
3	REC688-45341-00	688-45341-10	TAPÓN	PLUG, DRAIN	TAPPO	BOUCHON DE VIDANGE
4	REC6G5-45551-00	6G5-45551-01	PIÑÓN ATAQUE	INITIATIVE GEAR	MARCIA INIZIATIVA	PIGNON D'ATTAQUE
5	REC90170-16M01	93170-16M01	TUERCA	NUT	DADO	ECROU
6	REC93332-000V3	93332-000V3	RODAMIENTO	BEARING	CUSCINETTO	ROULEMENT
7	REC93315-425V3	93315-425V3	RODAMIENTO	BEARING	CUSCINETTO	ROULEMENT
8	REC6G5-45560-00	6G5-45560-01	PIÑÓN MARCHA AVANTE	POSITIVE GEAR ASSY	PIGNONE MARCIA AVANTI	PIGNON DE MARCHÉ AVANT
9	REC6E5-45641-03	6E5-45641-03	PITOT	PITOT	PITOT	PITOT
10	REC93507-32031	93507-32031	BOLA	BALL	BOLLA	BILLE
11	REC93503-16003	93503-16003	BOLA	BALL	BOLLA	BILLE
12	REC93511-32027	93511-32027	BOLA	BALL	BOLLA	BILLE
13	REC90501-16M37	90501-16M37	MUELLE	SPRING	MOLLA	RESSORT
14	REC90250-08M07	90250-08M07	PASADOR	PIN, STRAIGHT	SPINOTTO	CLAVETTE
15	REC6G5-45631-00	6G5-45631-00	DESPLAZABLE	CLUTCH, DOG	SCORREVOLE	CRABOT
16	REC6E5-45633-01	6E5-45633-01	ANILLO	RING, CROSS PIN	O-RING	JOINT TORIQUE
17	REC6J9-45611-00	6J9-45611-01	EJE HÉLICE	SHAFT, PROPELLER	ASSE ELICA	ARBRE D'HELICE
18	REC90201-30M92	90201-30M92	ARANDELA	WASHER, PLATE	RONDELLA	RONDELLE
19	REC6G5-45571-00	6G5-45571-02	PIÑÓN MARCHA ATRÁS	REVERSE GEAR	PIGNONE MARCIA INDIETRO	PIGNON MARCHÉ ARRIÈRE
20	REC93306-209U0	93306-209U0	RODAMIENTO	BEARING	CUSCINETTO	ROULEMENT
21	REC93210-97M55	93210-97M55	ARO TÓRICO	O-RING	O-RING	JOINT TORIQUE
22	REC6J9-45332-00-CA	6J9-45332-00-CA	DIÁBOLO	BEARING CARRIER	COP. CASSA INGRANAGGI	DIABOLO
23	REC93315-43061	93315-43061	RODAMIENTO	BEARING	CUSCINETTO	ROULEMENT
24	REC93101-30M17	93101-30M17	RETÉN	OIL SEAL	PARAOLIO	JOINT SPI
25	REC6G5-45383-01	6G5-45383-01	ARANDELA	WASHER, CLAW	RONDELLA	RONDELLE
26	REC6G5-45384-00	6G5-45384-00	TUERCA	NUT	DADO	ECROU
27	REC6E5-45987-00	6E5-45987-01	ESPACIADOR	SPACER	DISTANZIALE	ENTRETOISE
28	REC688-45997-00	688-45997-01	ESPACIADOR	SPACER	DISTANZIALE	ENTRETOISE
29	REC92990-18200	92990-18200	ARANDELA	WASHER	RONDELLA	RONDELLE
30	REC90171-18M04	90171-18M04	TUERCA	NUT, CASTLE	DADO	ECROU D'HELICE
31	REC91490-40030	91490-40030	PASADOR	PIN, COTTER	SPINOTTO	GOUPILLE
32	PAT85-00000012	90105-10M00	TORNILLO	SCREW	VITE	VIS
33	CM6E5-45371-01A	6E5-45371-01	ÁNODO	ANODE	ANODO	ANODE

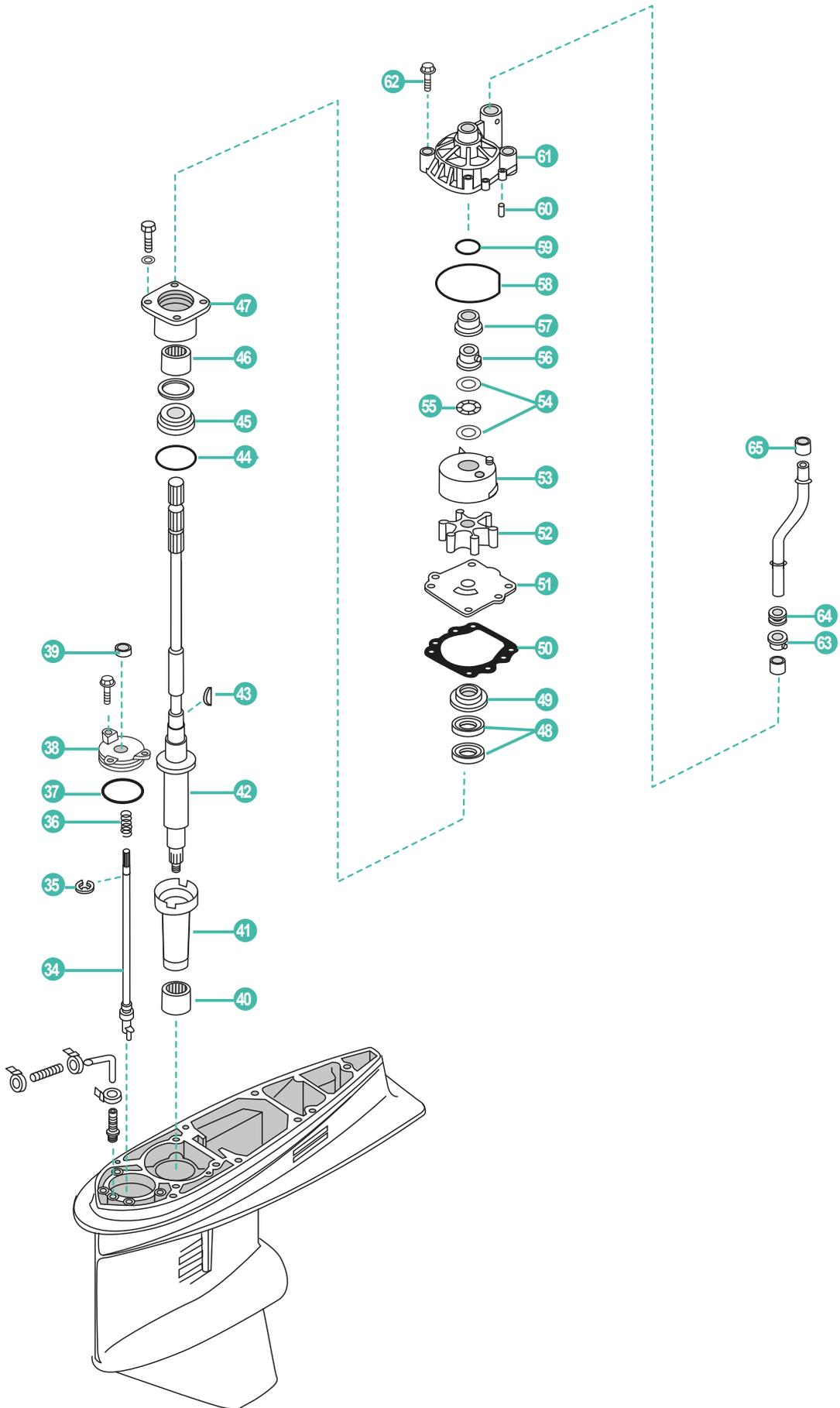

	REF	OEM				
34	REC6G5-44150-02	6G5-44150-02	EJE CAMBIO	SHIFT SHAFT	ASSE CAMBIO	LEVIER DE VITESSE
35	REC99001-08600-00	99001-08600	CLIP	BEARING	CUSCINETTO	ROULEMENT
36	REC90501-11M10-00	90501-11M10	MUELLE	SPRING	MOLLA	RESSORT
37	REC93210-58677	93210-58144	ARO TÓRICO	O-RING	O-RING	JOINT TORIQUE
38	REC6E5-45321-00	6E5-45321-00	TAPA EJE	SHIFT COVER	COPERCHIO ASSE	COUVERCLE
39	REC93106-09014	93106-09014	RETÉN	OIL SEAL	PARAOLIO	JOINT SPI
40	REC93311-928U5	93311-928U5	RODAMIENTO	BEARING	CUSCINETTO	ROULEMENT
41	REC6G5-45536-01	6G5-45536-01	CAMISA	LUBE SLEEVE	CAMICIA	DOUILLE
42	REC6G5-45501-21	6G5-45501-21	EJE 25"	DRIVE SHAFT COMP. 25"	ASSE VERTICALE 25"	ARBRE VERTICAL 25"
43	REC90280-04M05	90280-04M05	CHAVETA	KEY, WOODRUFF	CHIAVETTA	CLAVETTE
44	REC93210-54534	93210-55M14	ARO TÓRICO	O-RING	O-RING	JOINT TORIQUE
45	REC93341-930V2	93341-930V2	RODAMIENTO	BEARING	CUSCINETTO	ROULEMENT
46	REC93317-330U2	93317-330U2	RODAMIENTO	BEARING	CUSCINETTO	ROULEMENT
47	REC6E5-45331-00-94	6E5-45331-00-94	CUERPO RODAMIENTO	HOUSING, BEARING	SEDE CUSCINETTO	PALIER DE ROULEMENT
48	REC93101-28M16	93101-28M16	RETÉN	OIL SEAL	PARAOLIO	JOINT SPI
49	REC6E5-45344-00	6E5-45344-00	TAPA RETÉN	COVER, OIL SEAL	COPERCHIO	COUVERCLE JOINT SPI
50	REC6E5-44315-A0	6E5-44315-A0	JUNTA	GASKET, WATER PUMP	GUARNIZIONE	JOINT DE POMPE À EAU
51	REC6G5-44323-00	6G5-44323-00	PLATO	OUTER PLATE, CARTRIDGE	PIASTRA	PLAQUE DE POMPE À EAU
52	REC6E5-44352-01	6E5-44352-01	TURBINA	IMPELLER	GIRANTE	TURBINE
53	REC61A-44322-02	61A-44322-02	CASQUILLO INOX. -ANTIGUA-	INSERT, CARTRIDGE -OLDER-	BOCCOLA INOX. -ANTICA-	INSERT DE POMPE À EAU -ANCIEN MODÈLE-
	REC6E5-44322-00	6E5-44322-00	CASQUILLO INOX. -MODERNA-	INSERT, CARTRIDGE -NEWER-	BOCCOLA INOX. -NUOVA-	INSERT DE POMPE À EAU -NOUVEAU MODÈLE-
54	REC90206-22M19	90206-22M19	ARANDELA	WASHER	RONDELLA	RONDELLE
55	REC90201-22M01	90201-22M01	ARANDELA	WASHER	RONDELLA	RONDELLE
56	REC61A-45538-00	61A-45538-00	ESPACIADOR	SPACER	DISTANZIALE	ENTRETOISE
57	REC61A-45527-00	61A-45527-00	GOMA	COLLAR	GOMMA	BAGUE
58	REC93210-86M38	93210-86M38	ARO TÓRICO	O-RING	O-RING	JOINT TORIQUE
59	REC93210-37160	93210-37160	ARO TÓRICO	O-RING	O-RING	JOINT TORIQUE
60	REC93606-12019	93606-12019	CENTRADOR	PIN, DOWEL	SPINOTTO	PIN
61	REC61A-44311-00	61A-44311-01	CUERPO BOMBA AGUA -ANTIGUA-	HOUSTING, WATER PUMP -OLDER-	CORPO POMPA ACQUA -ANTICA-	CORPS DE POMPE À EAU -ANCIEN MODÈLE-
	REC6E5-44311-00	6E5-44311-00	CUERPO BOMBA AGUA -MODERNA-	HOUSTING, WATER PUMP -NEWER-	CORPO POMPA ACQUA -NUOVA-	CORPS DE POMPE À EAU -NOUVEAU MODÈLE-
62	REC90119-08M14	90119-08M14	TORNILLO	BOLT, WITH WASHER	VITE	VIS
63	REC6E5-44365-00	6E5-44365-00	CASQUILLO GOMA	DAMPER, WATER SEAL	BOCCOLA GOMMA	BAGUE
64	REC6E5-44366-00	6E5-44366-00	SELLO GOMA AGUA	DAMPER, WATER SEAL	BOCCOLA	BAGUE
65	REC6E5-44365-00	6E5-44365-00	SELLO GOMA AGUA	DAMPER, WATER SEAL	BOCCOLA	BAGUE

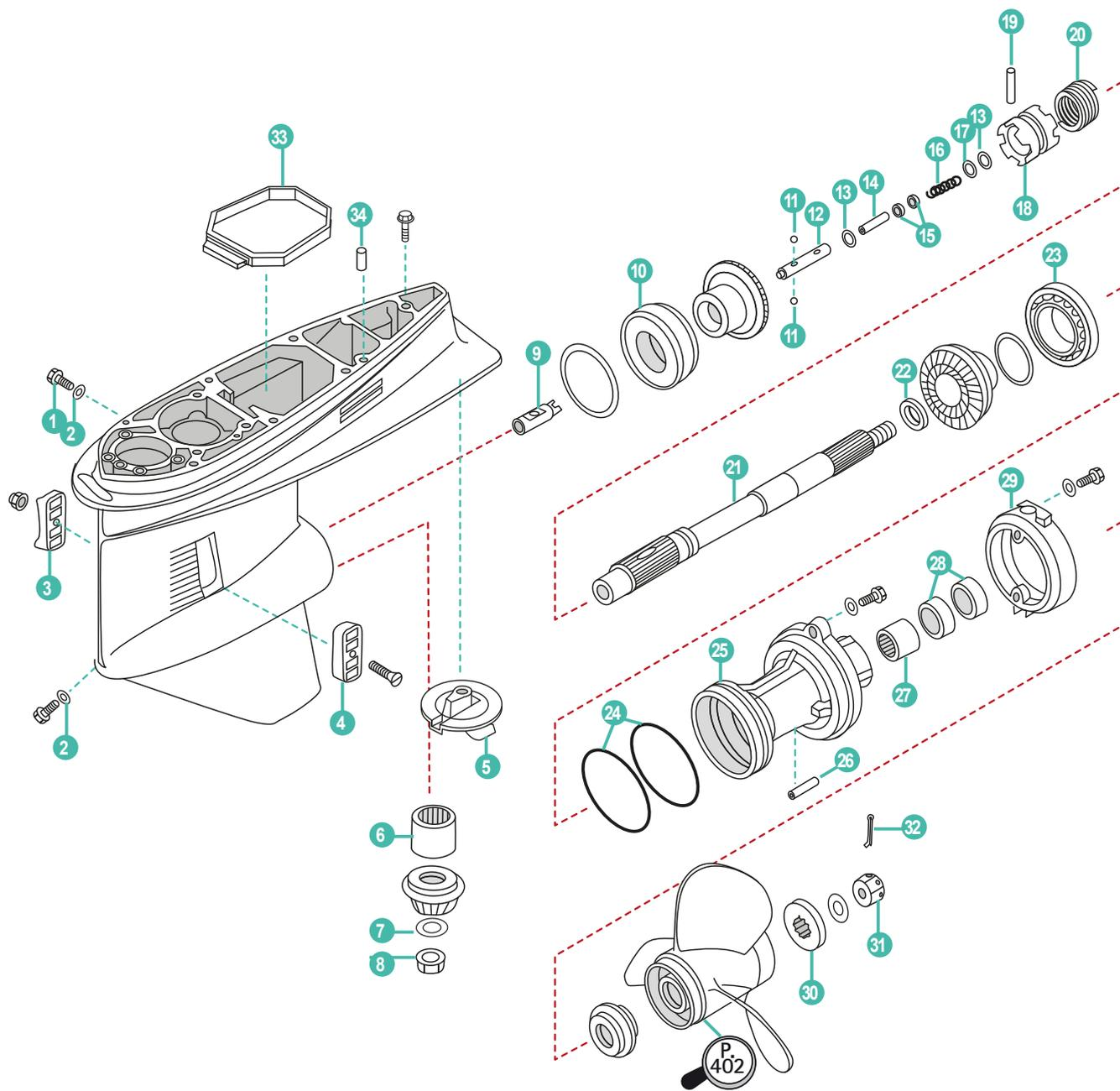



	REF	OEM				
1	REC90340-08002	90340-08002	TORNILLO	VENT PLUG	VITE	BOUCHON DE VIDANGE
2	REC90430-08020	90430-08020	JUNTA	GASKET, DRAIN PLUG	GUARNIZIONE	JOINT
3	REC61A-45215-10	61A-45215-10	FILTRO TAPA	WATER SCREEN, STD	COPERCHIO FILTRO	GRILLE D'ENTREE D'EAU
4	REC61A-45214-10	61A-45214-10	FILTRO TAPA	WATER SCREEN, PORT	COPERCHIO FILTRO	GRILLE D'ENTREE D'EAU
5	CM61A-45371	61A-45371-00	ÁNODO TIMÓN	TRIM TAB	ANODO	ANODE
6	REC93311-83280	93311-83280	RODAMIENTO	BEARING	CUSCINETTO	ROULEMENT
7	REC90201-16M00	90201-16M00	ARANDELA	WASHER	RONDELLA	RONDELLE
8	REC90170-16M19	90170-16M19	TUERCA DE PIÑÓN	PINION NUT	PIGNONE, DADO	ECROU DE PIGNON
9	REC61A-45641-02	61A-45641-02	DESPLAZABLE	SHIFTER	SCORREVOLE	DOUILLE
10	REC93332-000W1	93332-000W1	RODAMIENTO	BEARING	CUSCINETTO	ROULEMENT
11	REC93501-04011	93501-04011	BOLA	DETENT BALL	BOLLA	BILLE
12	REC61A-45634-01	61A-45634-01	DESPLAZABLE	SHIFT SLIDE	SCORREVOLE	DOUILLE
13	REC90183-02M03	90183-02M03	TUERCA	NUT	DADO	ECROU
14	REC6H1-45668-00	6H1-45668-00	EJE	FREE SHAFT	ASSE	ARBRE
15	REC61A-45635-00	61A-45635-00	GRUESO	SHIFT PLUNGER	SPESSORE	CALE
16	REC90501-10M77	90501-10M77	MUELLE	COMPRESSION SPRING	MOLLA	RESSORT
17	REC90201-02M00	90201-02M00	ARANDELA	PLATE WASHER	RONDELLA	RONDELLE
18	REC61A-45631-03	61A-45631-03	SELECTOR	CLUTCH, 2 STROKE	SELETTORE	CRABOT
19	REC61A-45632-00	61A-45632-00	PASADOR	CROSS PIN	SPINOTTO	CLAVETTE
20	REC61A-45633-00	61A-45633-00	MUELLE	SPRING	MOLLA	RESSORT
21	REC60V-45611-00	60V-45611-00	EJE HÉLICE	PROP SHAFT	ASSE ELICA	ARBRE D'HELICE
22	REC90201-31M00	90201-31M00	ARANDELA	WASHER	RONDELLA	RONDELLE
23	REC93306-210U0	93306-210U0	RODAMIENTO	BEARING	CUSCINETTO	PIGNON
24	REC93211-04384	93211-04384	ARO TÓRICO	O-RING, BEARING CARRIER	O-RING	JOINT TORIQUE
25	REC60V-45332-00-94	60V-45332-00-94	DIÁBOLO	BEARING CARRIER	COP. CASSA INGRANAGGI	DIABOLO
26	REC99590-10114	99590-10114	PIN CENTRADO	ALIGNMENT DOWEL	SPINOTTO	PIN ROULEMENT
27	REC93315-43061	93315-43061	RODAMIENTO	PROP SHAFT BEARING	CUSCINETTO	ROULEMENT
28	REC93101-30M17	93101-30M17	RETÉN	PROP SHAFT SEAL	PARAOILIO	JOINT SPI
29	REC69J-45361-00-8D	69J-45361-00-8D	FUNDA INFERIOR	CAP, LOWER CASING	COPERCHIO INFERIORE	COUVERCLE INFERIEUR
30	REC688-45997-00	688-45997-00	ESPACIADOR	SPACER	SPESSORE	ENTRETOISE
31	REC90171-18M04	90171-18M04	TUERCA	PROP NUT	DADO	ECROU D'HELICE
32	REC91490-40030	91490-40030	PIN	COTTER PIN	SPINOTTO	GOUPILLE
33	REC69J-45375-00	69J-45375-00	JUNTA ESCAPE	EXHAUST DAMPER	GUARNIZIONE1	JOINT D'ECHAPPEMENT
34	REC93608-12M05	93608-12M05	PIN	ALIGNMENT DOWELS	SPINOTTO	PIN

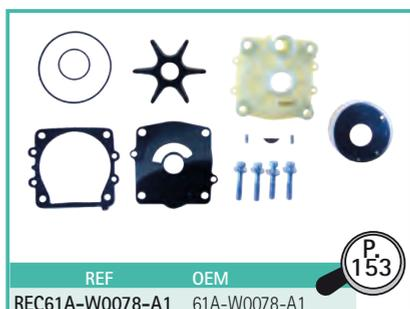

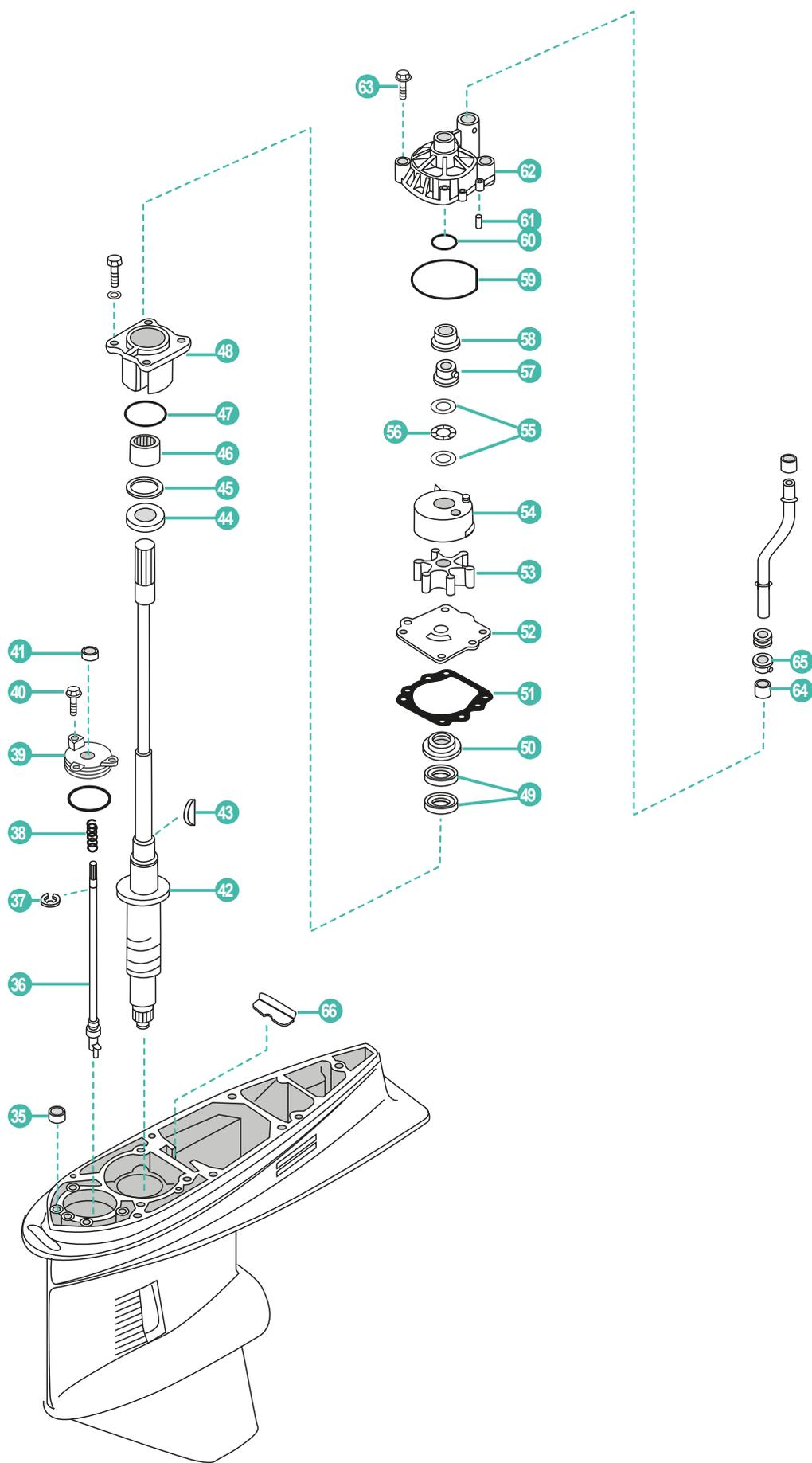

	REF	OEM				
35	REC663-44366-00	663-44366-00	GOMA	SEAL	GOMMA	BAGUE
36	REC60V-44150-00	60V-44150-00	EJE	SHIFT SHAFT	ASSE	LEVIER DE VITESSE
37	REC99001-08600-00	99001-08600	CLIP	CLIP	CLIP	CLAVETTE
38	REC90501-11M10-00	90501-11M10	MUELLE	SPRING	MOLLA	RESSORT
39	REC61A-45321-01	61A-45321-01	TAPA	SHIFT SHAFT COVER	COPERCHIO ASSE	COUVERCLE
40	REC90119-06M10	90119-06M10	TORNILLO	BOLT	VITE	VIS
41	REC93106-09014	93106-09014	RETÉN	SEAL, SHIFT ROD	BOCCOLA	JOINT
	REC66K-45501-00	66K-45501-00	EJE 20"	DRIVE SHAFT, 20"	ASSE VERTICALE 20"	ARBRE VERTICAL 20"
42	REC61A-45501-20	61A-45501-20	EJE 25"	DRIVE SHAFT, 25"	ASSE VERTICALE 25"	ARBRE VERTICAL 25"
	REC61A-45501-30	61A-45501-30	EJE 30"	DRIVE SHAFT, 30"	ASSE VERTICALE 30"	ARBRE VERTICAL 30"
43	REC90280-04M05	90280-04M05	CHAVETA	WOODRUFF KEY	CHIAVETTA	CLAVETTE
44	REC93341-93020	93341-93020	GRUESO RODAMIENTO	THRUST BEARING	SPESSORE CUSCINETTO	CALE
45	REC61A-45587-00/60-0	61A-45587-00/60	ESPACIADOR	SHIM KIT	SPESSORE	ENTRETOISE
46	REC93317-330U2	93317-330U2	RODAMIENTO	BEARING	CUSCINETTO	ROULEMENT
47	REC93210-54534	93210-54534	ARO TÓRICO	O-RING	O-RING	JOINT TORIQUE
48	REC61A-45331-00-94	61A-45331-00-94	CUERPO EJE	DRIVE SHAFT BEARING HOUSING	CORPO ASSE	PALIER DE ROULEMENT
49	REC93101-28M16	93101-28M16	RETÉN	DRIVE SHAFT SEAL	BOCCOLA	JOINT SPI
50	REC6E5-45344-00	6E5-45344-00	RETÉN	COVER, DRIVE SHAFT SEALS	BOCCOLA	COUVERCLE DE JOINT SPI
51	REC6E5-44315-A0	6E5-44315-A0	JUNTA BASE	BASE GASKET	GUARNIZIONE	JOINT
52	REC6G5-44323-00	6G5-44323-00	BASE BOMBA	WEAR PLATE	BASE POMPA	PLAQUE DE POMPE À EAU
53	REC6E5-44352-01	6E5-44352-01	TURBINA	IMPELLER	GIRANTE	TURBINE
54	REC61A-44322-02	61A-44322-02	CASQUILLO INOX.	WATER PUMP LINER	BOCCOLA	INSERT DE POMPE À EAU
55	REC90201-22M01	90201-22M01	ARANDELA	WASHER	RONDELLA	RONDELLE
56	REC90206-22M19	90206-22M19	TÓRICA	WAVE WASHER	GUARNIZIONE	JOINT TORIQUE
57	REC61A-45538-00	61A-45538-00	ESPACIADOR	SPACER	DISTANZIALE	ENTRETOISE
58	REC61A-45527-00	61A-45527-00	COLLAR	COLLAR	COLLAR	BAGUE
59	REC93210-86M38	93210-86M38	ARO TÓRICO	O-RING	O-RING	JOINT TORIQUE
60	REC93210-37M67	93210-37M67	ARO TÓRICO	O-RING	O-RING	JOINT TORIQUE
61	REC93606-12019	93606-12019	PASADOR CENTRAL	ALIGNMENT PIN	SPINOTTO	PIN
62	REC61A-44311-00	61A-44311-00	CUERPO BOMBA AGUA	WATER PUMP HOUSING	CORPO POMPA ACQUA	CORPS DE POMPE À EAU
63	REC90119-08M14	90119-08M14	TORNILLO CON ARANDELA	BOLT WITH WASHER	VITE	VIS
64	REC6E5-44365-00	6E5-44365-00	CASQUILLO JUNTA	DAMPER, WATER TUBE	BOCCOLA TUBO	BAGUE
65	REC6E5-44312-00	6E5-44312-00	TAPA	OVER	TAPPO	BAGUE
66	REC61A-45376-00-94	61A-45376-00-94	GUÍA	GUIDE	GUIDE	GUIDE

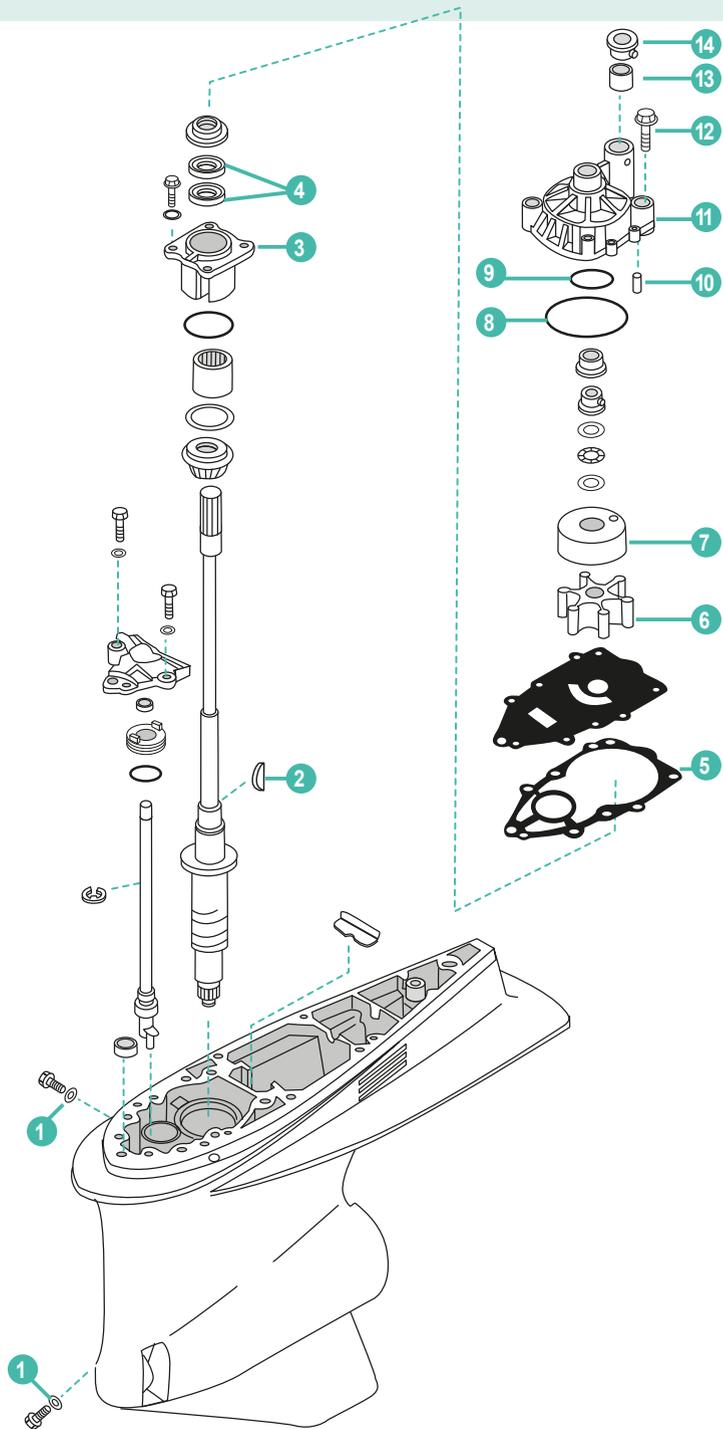

	REF	OEM				
1	REC90430-08020	93430-08020	JUNTA	GASKET, DRAIN FILL	GUARNIZIONE	JOINT
2	REC90280-04M05	90280-04M05	CHAVETA	KEY, WOODRUFF	CHIAVETTA	CLAVETTE
3	REC61A-45331-00-94	61A-45331-00-94	CUERPO COJINETE EJE	DRIVE SHAFT BEARING HOUSING	CORPO CUSCINETTO	PALIER DE ROULEMENT
4	REC93101-28M16	93101-28M16	RETÉN	OIL SEAL	PARAOILIO	JOINT SPI
5	REC60X-44315-A0	60X-44315-A0	JUNTA	GASKET	GUARNIZIONE	JOINT
6	REC6E5-44352-01	6E5-44352-01	IMPULSOR	IMPELLER	GIRANTE	TURBINE
7	REC61A-44322-02	61A-44322-02	CASQUILLO INOX.	PUMP CUP	BOCCOLA INOX.	INSERT DE POMPE À EAU
8	REC93210-86M38	93210-86M38	ARO TÓRICO	O-RING	O-RING	JOINT TORIQUE
9	REC93210-37M67	93210-37M67	ARO TÓRICO	O-RING	O-RING	JOINT TORIQUE
10	REC93606-12019	93606-42019	PASADOR	PIN, DOWELL	SPINOTTO	PIN
11	REC61A-44311-00	61A-44311-01	CUERPO BOMBA AGUA	WATER PUMP HOUSING	CORPO POMPA ACQUA	CORPS DE POMPE À EAU
12	REC90119-08M14	90119-08M14	TORNILLO CON ARANDELA	BOLT W WASHER	VITE	VIS
13	REC6E5-44365-00	6E5-44365-00	CASQUILLO GOMA	DAMPER	BOCCOLA GOMMA	BAGUE
13	REC6E5-44312-00	6E5-44312-00	TAPA CUERPO BOMBA AGUA	COVER, WATER PUMP HOUSING	COPERCHIO CORPO POMPA	COUVERCLE

GUÍA PIEZAS COLA

STERN DRIVE  
COMPONENTS GUIDE

GUIDA RICAMBI  
PIEDI

GUIDE PIÈCES  
D'EMBASE



2B	1981-03	REC646-45551-00	REC646-45560-00						
4A	1985-87	REC6E0-45551-00	REC6E0-45560-00	REC6E0-45570-00	REC6E0-45631-00		PAF4-03050001	REC6E0-45511-01	
4AC	1987-99	REC6E0-45551-00	REC6E0-45560-00	REC6E0-45570-00	REC6E0-45631-00		PAF4-03050001	REC6E0-45511-01	
4AC MHL 4AC MHS	2001-03	REC6E0-45551-00	REC6E0-45560-00	REC6E0-45570-00	REC6E0-45631-00		PAF4-03050001	REC6E0-45511-11	
4AS	1987-96	REC6E0-45551-00	REC6E0-45560-00	REC6E0-45570-00	REC6E0-45631-00		PAF4-03050001	REC6E0-45511-01	
4BC	1998-99	REC6E0-45551-00	REC6E0-45560-00	REC6E0-45570-00	REC6E0-45631-00		PAF4-03050001	REC6E0-45511-01	
4BC	1999	REC6E0-45551-00	REC6E0-45560-00	REC6E0-45570-00	REC6E0-45631-00		PAF4-03050001	REC6E0-45511-01	
4BC MHL 4BC MHS	2001-03	REC6E0-45551-00	REC6E0-45560-00	REC6E0-45570-00	REC6E0-45631-00		PAF4-03050001	REC6E0-45511-11	
F4A	1998-00	REC6E0-45551-00	PAF4-03010000	PAF4-03040000			PAF4-03050001	REC6E0-45511-11	
F4A MH F4A MHL	2000	REC6E0-45551-00	PAF4-03010000	PAF4-03040000			PAF4-03050001	REC6E0-45511-11	
F4A MHS	2001	REC6E0-45551-00	PAF4-03010000	PAF4-03040000			PAF4-03050001	REC6E0-45511-11	
5C	1985-99	REC6E0-45551-00	REC6E0-45560-00	REC6E0-45570-00	REC6E0-45631-00		PAF4-03050001	REC6E0-45511-01	
5C MHL 5C MHS	2001-06	REC6E0-45551-00	REC646-45560-00	REC6E0-45570-00	REC6E0-45631-00		PAF4-03050001	REC6E0-45511-11	
5CS	1987-96	REC6E0-45551-00	REC646-45560-00	REC6E0-45570-00	REC6E0-45631-00			REC6E0-45511-01	
6C	1990-98	REC6NO-G5551-00	REC6NO-G5560-00	REC6NO-G5571-00	REC6G1-45631-00		REC6G1-45611-01		
6C MHL 6C MHS	2001-06	REC6NO-G5551-00	REC6NO-G5560-00	REC6NO-G5571-00	REC6G1-45631-00		REC6G1-45611-01		
6C WHL 6C WHS	2001	REC6NO-G5551-00	REC6NO-G5560-00	REC6NO-G5571-00	REC6G1-45631-00		REC6G1-45611-01		
6D	1990-98	REC6NO-G5551-00	REC6NO-G5560-00	REC6NO-G5571-00	REC6G1-45631-00		REC6G1-45611-01		
6D MHL 6D MHS	2001-06	REC6NO-G5551-00	REC6NO-G5560-00	REC6NO-G5571-00	REC6G1-45631-00		REC6G1-45611-01		
6D WHS	2001	REC6NO-G5551-00	REC6NO-G5560-00	REC6NO-G5571-00	REC6G1-45631-00		REC6G1-45611-01		
8C	1990-98	REC6NO-G5551-00	REC6NO-G5560-00	REC6NO-G5571-00	REC6G1-45631-00		REC6G1-45611-01		
8C MHL 8C MHS	2001-06	REC6NO-G5551-00	REC6NO-G5560-00	REC6NO-G5571-00	REC6G1-45631-00		REC6G1-45611-01		
8C MHX	2001-03	REC6NO-G5551-00	REC6NO-G5560-00	REC6NO-G5571-00	REC6G1-45631-00		REC6G1-45611-01		
8C WHL 8C WHS	2001-03	REC6NO-G5551-00	REC6NO-G5560-00	REC6NO-G5571-00	REC6G1-45631-00		REC6G1-45611-01		
E8D	1997-98	REC647-45551-00	REC647-45560-00	REC647-45570-00					
E8D MH	1999	REC647-45551-00	REC647-45560-00	REC647-45570-00					
F8A	1986-89				REC682-45631-00	REC648-45633-00			
F8B	1985-99	REC6E7-45551-00	REC6E7-45560-01	REC6E7-45570-00	REC682-45631-00	REC648-45633-00	REC683-45611-00		
F8B E F8B EH F8B MH	1999	REC6E7-45551-00	REC6E7-45560-01	REC6E7-45570-00	REC682-45631-00	REC648-45633-00	REC683-45611-00		
FT8D EL	2001-04					REC648-45633-00	REC683-45611-00		REC69G-45510-20
FT8D EPL	2001-04					REC648-45633-00	REC683-45611-00		REC69G-45510-10
FT8D EPX	2001-02					REC648-45633-00	REC683-45611-00		REC69G-45510-10
FT8D EX	2001-04					REC648-45633-00	REC683-45611-00		REC69G-45510-20
FT8D MHL FT8D MHX	2001-04					REC648-45633-00	REC683-45611-00		REC69G-45510-10
9.9D	1985-89	REC6E7-45551-00	REC6E7-45560-01	REC6E7-45570-00	REC682-45631-00	REC648-45633-00	REC683-45611-00		REC69G-45510-20
9.9D	1990-95	REC6E7-45551-00	REC6E7-45560-01	REC6E7-45570-00	REC682-45631-00	REC648-45633-00	REC683-45611-00	REC683-45361-02-4D	REC6E7-45501-11 REC63V-45510-01
9.9F	1995-99	REC63V-45551-00	REC6E7-45560-01	REC6E7-45570-00	REC682-45631-00	REC648-45633-00	REC683-45611-00	REC683-45361-02-4D	REC63V-45501-10 REC63V-45510-01 REC63V-45510-11
9.9F MH	2000	REC63V-45551-00	REC6E7-45560-01	REC6E7-45570-00	REC682-45631-00	REC648-45633-00	REC683-45611-00	REC683-45361-02-4D	REC63V-45510-11 REC63V-45510-01 REC63V-45510-11
9.9F MHL 9.9F MHS 9.9F WC 9.9F WH	2001-06	REC63V-45551-00	REC6E7-45560-01	REC6E7-45570-00	REC682-45631-00	REC648-45633-00	REC683-45611-00	REC683-45361-02-4D	REC63V-45510-11 REC63V-45510-01 REC63V-45510-11
9.9F WHL 9.9F WHS	2001	REC63V-45551-00	REC6E7-45560-01	REC6E7-45570-00	REC682-45631-00	REC648-45633-00	REC683-45611-00	REC683-45361-02-4D	REC63V-45510-01 REC63V-45510-11
F9.9B	1985-97	REC6E7-45551-00	REC6E7-45560-01	REC6E7-45570-00	REC682-45631-00	REC648-45633-00	REC683-45611-00	REC683-45361-02-4D	
F9.9B E	1999	REC6E7-45551-00	REC6E7-45560-01	REC6E7-45570-00	REC682-45631-00	REC648-45633-00	REC683-45611-00	REC683-45361-02-4D	
F9.9B EH	1999	REC6E7-45551-00	REC6E7-45560-01	REC6E7-45570-00	REC682-45631-00	REC648-45633-00	REC683-45611-00	REC683-45361-02-4D	
F9.9B MH	1999	REC6E7-45551-00	REC6E7-45560-01	REC6E7-45570-00	REC682-45631-00	REC648-45633-00	REC683-45611-00	REC683-45361-02-4D	
F9.9C	1998	REC63V-45551-00	REC6E7-45560-01	REC6E7-45570-00	REC682-45631-00	REC648-45633-00	REC683-45611-00	REC683-45361-02-4D	REC63V-45510-01 REC63V-45510-11
F9.9C E	2000	REC63V-45551-00	REC6E7-45560-01	REC6E7-45570-00	REC682-45631-00	REC648-45633-00	REC683-45611-00	REC683-45361-02-4D	REC63V-45510-01 REC63V-45510-11
F9.9C EH	2000	REC63V-45551-00	REC6E7-45560-01	REC6E7-45570-00	REC682-45631-00	REC648-45633-00	REC683-45611-00	REC683-45361-02-4D	REC63V-45510-01 REC63V-45510-11
F9.9C EL F9.9C ES	2001-06	REC63V-45551-00	REC6E7-45560-01	REC6E7-45570-00	REC682-45631-00	REC648-45633-00	REC683-45611-00	REC683-45361-02-4D	REC63V-45510-01 REC63V-45510-11
F9.9C MH	2000	REC63V-45551-00	REC6E7-45560-01	REC6E7-45570-00	REC682-45631-00	REC648-45633-00	REC683-45611-00	REC683-45361-02-4D	REC63V-45510-01 REC63V-45510-11
F9.9C MHL F9.9C MHS	2001-06	REC63V-45551-00	REC6E7-45560-01	REC6E7-45570-00	REC682-45631-00	REC648-45633-00	REC683-45611-00	REC683-45361-02-4D	REC63V-45510-01 REC63V-45510-11
FT9.9A	1999				REC682-45631-00	REC648-45633-00			
FT9.9D	1999				REC682-45631-00	REC648-45633-00	REC683-45611-00		
FT9.9D E FT9.9D EH	2000				REC682-45631-00	REC648-45633-00	REC683-45611-00		
FT9.9D EHL FT9.9D EHX	2001				REC682-45631-00	REC648-45633-00	REC683-45611-00		





25D MH	1998	REC689-45551-00	REC689-45560-00	REC689-45571-00-00	REC664-45631-00	REC648-45633-00		PAF25-04070000	REC689-45501-10
25D MHL									
25D MHS	2001	REC689-45551-00	REC689-45560-00	REC689-45571-00-00	REC664-45631-00	REC648-45633-00		PAF25-04070000	
25J	1987-91					REC648-45633-00		PAF25-04070000	
25J	1992-00					REC648-45633-00		PAF25-04070000	
25N	1988					REC648-45633-00	REC6L2-45611-00	PAF25-04070000	
25N MHOL									
25N MHOS	2001-06					REC648-45633-00	REC6L2-45611-00	PAF25-04070000	
25N WOL									
25N WOS	2001-03					REC648-45633-00	REC6L2-45611-00	PAF25-04070000	
25Q	1988-94	REC6H4-45551-00	REC6H4-45560-00	REC6H4-45570-00	REC663-45631-00	REC648-45633-00	REC679-45611-00	PAF25-04070000	
25V	1996	REC61N-45551-00	REC61N-45560-10	REC61N-45570-00	REC664-45631-00	REC648-45633-00	REC6L2-45611-00	PAF25-04070000	REC61N-45510-10
25V	1996-98	REC61N-45551-00	REC61N-45560-10	REC61N-45570-00	REC664-45631-00	REC648-45633-00	REC6L2-45611-00	PAF25-04070000	REC61N-45510-10
25V MHL									
25V MHS	2001	REC61N-45551-00	REC61N-45560-10	REC61N-45570-00	REC664-45631-00	REC648-45633-00	REC6L2-45611-00	PAF25-04070000	REC61N-45510-10
25V WCS	2001	REC61N-45551-00	REC61N-45560-10	REC61N-45570-00	REC664-45631-00	REC648-45633-00	REC6L2-45611-00	PAF25-04070000	REC61N-45510-10
F25A E									
F25A EH	2000	REC61N-45551-00	REC61N-45560-10	REC61N-45570-00	REC664-45631-00	REC648-45633-00	REC6L2-45611-00	PAF25-04070000	REC61N-45510-10
F25A EHL	2001-02	REC61N-45551-00	REC61N-45560-10	REC61N-45570-00	REC664-45631-00	REC648-45633-00	REC6L2-45611-00	PAF25-04070000	REC61N-45510-10
F25A EHS	2001	REC61N-45551-00	REC61N-45560-10	REC61N-45570-00	REC664-45631-00	REC648-45633-00	REC6L2-45611-00	PAF25-04070000	REC61N-45510-10
F25A EL									
F25A ES	2001-06	REC61N-45551-00	REC61N-45560-10	REC61N-45570-00	REC664-45631-00	REC648-45633-00	REC6L2-45611-00	PAF25-04070000	REC61N-45510-10
F25A ET	2000	REC61N-45551-00	REC61N-45560-10	REC61N-45570-00	REC664-45631-00	REC648-45633-00	REC6L2-45611-00	PAF25-04070000	REC61N-45510-10
F25A ETL	2001-06	REC61N-45551-00	REC61N-45560-10	REC61N-45570-00	REC664-45631-00	REC648-45633-00	REC6L2-45611-00	PAF25-04070000	REC61N-45510-10
F25A MH	2000	REC61N-45551-00	REC61N-45560-10	REC61N-45570-00	REC664-45631-00	REC648-45633-00	REC6L2-45611-00	PAF25-04070000	REC61N-45510-10
F25A MHL									
F25A MHS	2001-06	REC61N-45551-00	REC61N-45560-10	REC61N-45570-00	REC664-45631-00	REC648-45633-00	REC6L2-45611-00	PAF25-04070000	REC61N-45510-10
FT25B ED	2000						REC66T-45611-00	REC63D-45361-02-4D	
FT25B EDL									
FT25B EDX	2001-02						REC66T-45611-00	REC63D-45361-02-4D	
FT25B ET	2000						REC66T-45611-00	REC63D-45361-02-4D	
FT25B ETL	2001-06						REC66T-45611-00	REC63D-45361-02-4D	
FT25B ETX	2001-02						REC66T-45611-00	REC63D-45361-02-4D	
30A	1985	REC689-45551-00	REC689-45560-00	REC689-45571-00-00	REC664-45631-00	REC648-45633-00	REC689-45611-00		
30A M	1990-92	REC689-45551-00	REC689-45560-00	REC689-45571-00-00	REC664-45631-00	REC648-45633-00	REC689-45611-00		REC689-45501-10
30D	1986-00					REC648-45633-00			
30D EOL									
30D EOS									
30D ETOL	2001-06					REC648-45633-00			
30D MHOL									
30D MHOS									
30D OL	2001-03					REC648-45633-00			
30D EOS	2001-06					REC648-45633-00			
30G	1996	REC61N-45551-00	REC61N-45560-10	REC61N-45570-00	REC664-45631-00	REC648-45633-00	REC6L2-45611-00	PAF25-04070000	REC61N-45510-10
30G	1996-98	REC61N-45551-00	REC61N-45560-10	REC61N-45570-00	REC664-45631-00	REC648-45633-00	REC6L2-45611-00	PAF25-04070000	REC61N-45510-10
30G MHS									
30G WCS	2001	REC61N-45551-00	REC61N-45560-10	REC61N-45570-00		REC648-45633-00	REC6L2-45611-00	PAF25-04070000	REC61N-45510-10
30H MHS	2001-02	REC61N-45551-00	REC61N-45560-10	REC61N-45570-00	REC664-45631-00	REC648-45633-00	REC6L2-45611-00	PAF25-04070000	REC61N-45510-10
30H WCS	2001-02	REC61N-45551-00	REC61N-45560-10	REC61N-45570-00	REC664-45631-00	REC648-45633-00	REC6L2-45611-00	PAF25-04070000	REC61N-45510-10
F30A ETL	2001-06	REC66T-45551-00	REC66T-45560-00	REC66T-45571-00	REC66T-45631-00		REC66T-45611-00	REC63D-45361-02-4D	REC67C-45501-10
F30A ETS	2001-06	REC66T-45551-00	REC66T-45560-00	REC66T-45571-00	REC66T-45631-00		REC66T-45611-00	REC63D-45361-02-4D	REC67C-45501-10
F30A MHDL	2001-06	REC66T-45551-00	REC66T-45560-00	REC66T-45571-00	REC66T-45631-00		REC66T-45611-00	REC63D-45361-02-4D	REC67C-45501-10
F30A MHDS	2001-06	REC66T-45551-00	REC66T-45560-00	REC66T-45571-00	REC66T-45631-00		REC66T-45611-00	REC63D-45361-02-4D	REC67C-45501-10
E40G WH	2003	REC6F5-45551-00	REC6F5-45560-00	REC6F5-45570-00	REC663-45631-00	REC663-45633-00	REC6F6-45611-00	REC63D-45361-02-4D	REC676-45501-10
40H	1985-90	REC6H4-45551-00	REC6H4-45560-00	REC6H4-45570-00	REC6H4-45631-00	REC663-45633-00	REC679-45611-00		
40H	1991-93	REC6H4-45551-00	REC6H4-45560-00	REC6H4-45570-00	REC6H4-45631-00	REC663-45633-00	REC679-45611-00		
40Q	1993-98	REC6H9-45551-00	REC679-45560-00	REC677-41112-A0	REC663-45631-00	REC663-45633-00	REC679-45611-00		REC679-45501-10
40Q E	1992	REC6H9-45551-00	REC679-45560-00	REC677-41112-A0	REC663-45631-00	REC663-45633-00	REC679-45611-00		REC679-45501-10
40Q M	1990-92	REC6H9-45551-00	REC679-45560-00	REC677-41112-A0	REC663-45631-00	REC663-45633-00	REC679-45611-00		REC679-45501-10
40R MHO	2000	REC6H4-45551-00	REC6H4-45560-00	REC6H4-45570-00		REC663-45633-00		REC63D-45361-02-4D	
40R ROS	2001	REC6H4-45551-00	REC6H4-45560-00	REC6H4-45570-00		REC663-45633-00		REC63D-45361-02-4D	
40V	1995-98	REC6H4-45551-00	REC6H4-45560-00	REC6H4-45570-00		REC663-45633-00		REC63D-45361-02-4D	
40V EO	2000	REC6H4-45551-00	REC6H4-45560-00	REC6H4-45570-00		REC663-45633-00		REC63D-45361-02-4D	
40V EOL									
40V EOS	2001-06	REC6H4-45551-00	REC6H4-45560-00	REC6H4-45570-00		REC663-45633-00		REC63D-45361-02-4D	
40V ETO	2000	REC6H4-45551-00	REC6H4-45560-00	REC6H4-45570-00		REC663-45633-00		REC63D-45361-02-4D	
40V ETOL									
40V ETOS	2001-03	REC6H4-45551-00	REC6H4-45560-00	REC6H4-45570-00		REC663-45633-00		REC63D-45361-02-4D	
40V MHOL									
40V MHOS	2001-06	REC6H4-45551-00	REC6H4-45560-00	REC6H4-45570-00		REC663-45633-00		REC63D-45361-02-4D	
40V MO	2000	REC6H4-45551-00	REC6H4-45560-00	REC6H4-45570-00		REC663-45633-00		REC63D-45361-02-4D	
40X	1998	REC66T-45551-00	REC66T-45560-00	REC66T-45571-00	REC66T-45631-00	REC663-45633-00	REC66T-45611-00	REC63D-45361-02-4D	REC66T-45501-10
40X MH	2000	REC66T-45551-00	REC66T-45560-00	REC66T-45571-00	REC66T-45631-00	REC663-45633-00	REC66T-45611-00	REC63D-45361-02-4D	REC66T-45501-10
40X MHL	2001-06	REC66T-45551-00	REC66T-45560-00	REC66T-45571-00	REC66T-45631-00	REC663-45633-00	REC66T-45611-00	REC63D-45361-02-4D	REC66T-45501-10
40X MHS	2001-02	REC66T-45551-00	REC66T-45560-00	REC66T-45571-00	REC66T-45631-00	REC663-45633-00	REC66T-45611-00	REC63D-45361-02-4D	REC66T-45501-01
40X W	2000	REC66T-45551-00	REC66T-45560-00	REC66T-45571-00	REC66T-45631-00	REC663-45633-00	REC66T-45611-00	REC63D-45361-02-4D	REC66T-45501-10
40X WL									
40X WS	2001	REC66T-45551-00	REC66T-45560-00	REC66T-45571-00	REC66T-45631-00	REC663-45633-00	REC66T-45611-00	REC63D-45361-02-4D	REC66T-45501-10









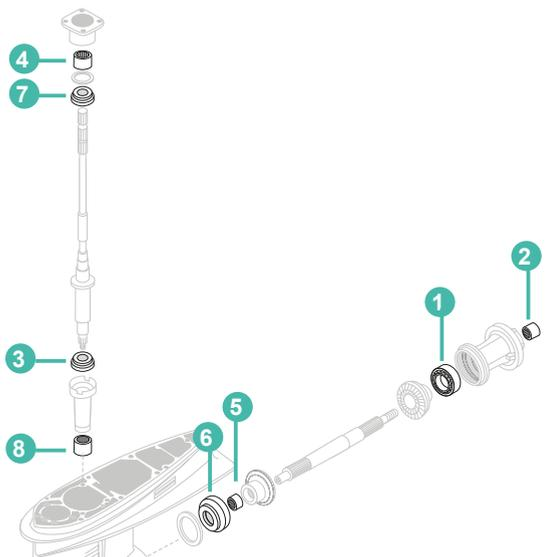

**GUÍA RODAMIENTOS STERN DRIVE BEARING GUIDA CUSCINETTI GUIDE ROULEMENTS APPLICATION TRASMISIONE D'EMBASE**

		1	2	3	4	5	6	7	8
F8A	1986-89				REC93315-317U2		REC93332-00005		REC93306-00501
F8B	1985-99	REC93315-314V8		REC93341-214U1	REC93315-317U2		REC93332-00005		REC93306-00501
F8B E F8B EH F8B MH	1999	REC93315-314V8		REC93341-41414	REC93315-317U2		REC93332-00005		REC93306-00501
FT8D EL FT8D EPL	2001-04	REC93315-314V8		REC93341-41414	REC93315-317U2		REC93332-00005		REC93306-00501
FT8D EPX	2001-02	REC93315-314V8		REC93341-41414	REC93315-317U2		REC93332-00005		REC93306-00501
FT8D EX FT8D MHL FT8D MHX	2001-04	REC93315-314V8		REC93341-41414	REC93315-317U2		REC93332-00005		REC93306-00501
9.9D	1985-89	REC93315-314V8		REC93341-41414	REC93315-317U2		REC93332-00005		REC93306-00501
9.9D	1985-95	REC93315-314V8		REC93341-214U1	REC93315-317U2		REC93332-00005		REC93306-00501
9.9D	1990-95	REC93315-314V8		REC93341-41414	REC93315-317U2		REC93332-00005		REC93306-00519
9.9F	1995-99	REC93315-314V8		REC93341-41414	REC93315-317U2		REC93332-00005		REC93306-00501
9.9F MH	2000	REC93315-314V8		REC93341-41414	REC93315-317U2		REC93332-00005		REC93306-00501
9.9F MHL 9.9F MHS	2001-06	REC93315-314V8		REC93341-41414	REC93315-317U2		REC93332-00005		REC93306-00501
9.9F WC 9.9F WH	2000	REC93315-314V8		REC93341-41414	REC93315-317U2		REC93332-00005		REC93306-00501
9.9F WHL 9.9F WHS	2001	REC93315-314V8		REC93341-41414	REC93315-317U2		REC93332-00005		REC93306-00501
F9.9B	1985-97	REC93315-314V8		REC93341-214U1	REC93315-317U2		REC93332-00005		REC93306-00501
F9.9B E F9.9B EH F9.9B MH	1999	REC93315-314V8		REC93341-41414	REC93315-317U2		REC93332-00005		REC93306-00501
F9.9C	1998	REC93315-314V8		REC93341-41414	REC93315-317U2		REC93332-00005		REC93306-00501
F9.9C E F9.9C EH	2000	REC93315-314V8		REC93341-41414	REC93315-317U2		REC93332-00005		REC93306-00501
F9.9C EL F9.9C ES	2001-06	REC93315-314V8		REC93341-41414	REC93315-317U2		REC93332-00005		REC93306-00501
F9.9C MH	2000	REC93315-314V8		REC93341-41414	REC93315-317U2		REC93332-00005		REC93306-00501
F9.9C MHL F9.9C MHS	2001-06	REC93315-314V8		REC93341-41414	REC93315-317U2		REC93332-00005		REC93306-00501
FT9.9A	1999				REC93315-317U2		REC93332-00005		REC93306-00501
FT9.9D	1999	REC93315-314V8		REC93341-41414	REC93315-317U2		REC93332-00005		REC93306-00501
FT9.9D E FT9.9D EH	2000	REC93315-314V8		REC93341-41414	REC93315-317U2		REC93332-00005		REC93306-00501
FT9.9D EHL FT9.9D EHX	2001	REC93315-314V8		REC93341-41414	REC93315-317U2		REC93332-00005		REC93306-00501
FT9.9D EL	2001-06	REC93315-314V8		REC93341-41414	REC93315-317U2		REC93332-00005		REC93306-00501
FT9.9D EP	2000	REC93315-314V8		REC93341-41414	REC93315-317U2		REC93332-00005		REC93306-00501
FT9.9D EPL FT9.9D EPX	2001-02	REC93315-314V8		REC93341-41414	REC93315-317U2		REC93332-00005		REC93306-00501
FT9.9D ES	2001	REC93315-314V8		REC93341-41414	REC93315-317U2		REC93332-00005		REC93306-00501
FT9.9D EX	2001-06	REC93315-314V8		REC93341-41414	REC93315-317U2		REC93332-00005		REC93306-00501
FT9.9D MH	2000	REC93315-314V8		REC93341-41414	REC93315-317U2		REC93332-00005		REC93306-00501
FT9.9D MHL	2001-06	REC93315-314V8		REC93341-41414	REC93315-317U2		REC93332-00005		REC93306-00501
FT9.9D MHX	2001	REC93315-314V8		REC93341-41414	REC93315-317U2		REC93332-00005		REC93306-00501
13.5A	1999	REC93315-314V8		REC93341-41414	REC93315-317U2		REC93332-00005		REC93306-00501
13.5A MH	2000	REC93315-314V8		REC93341-41414	REC93315-317U2		REC93332-00005		REC93306-00501
13.5A MHL 13.5A MHS	2001-04	REC93315-314V8		REC93341-41414	REC93315-317U2		REC93332-00005		REC93306-00501
13.5A WH	2000	REC93315-314V8		REC93341-41414	REC93315-317U2		REC93332-00005		REC93306-00501
F13.5A EHL	2005-06	REC93315-314V8			REC93315-317U2		REC93332-00005		REC93306-00501
F13.5A EPL	2005	REC93315-314V8		REC93341-41414	REC93315-317U2		REC93332-00005		REC93306-00501
F13.5A EPS	2005	REC93315-314V8			REC93315-317U2		REC93332-00005		REC93306-00501
F13.5A MH	2001	REC93315-314V8			REC93315-317U2				REC93306-00501
F13.5A MHL F13.5A MHS	2002-06	REC93315-314V8		REC93341-41414	REC93315-317U2		REC93332-00005		REC93306-00501

		1	2	3	4	5	6	7	8
15D	1985-95	REC93315-314V8		REC93341-214U1	REC93315-317U2		REC93332-00005		REC93306-00501
15D	1990-95	REC93315-314V8		REC93341-41414	REC93315-317U2		REC93332-00005		REC93306-00501
15F	1995-99	REC93315-314V8		REC93341-41414	REC93315-317U2		REC93332-00005		REC93306-00501
15F MH	2000	REC93315-314V8		REC93341-41414	REC93315-317U2		REC93332-00005		REC93306-00501
15F MHL 15F MHS	2001-06	REC93315-314V8		REC93341-41414	REC93315-317U2		REC93332-00005		REC93306-00501
15F WC	2000	REC93315-314V8		REC93341-41414	REC93315-317U2		REC93332-00005		REC93306-00501
15F WCL	2001-03	REC93315-314V8		REC93341-41414	REC93315-317U2		REC93332-00005		REC93306-00501
15F WCS	2001-02	REC93315-314V8		REC93341-41414	REC93315-317U2		REC93332-00005		REC93306-00501
F15A	1998	REC93315-314V8		REC93341-41414	REC93315-317U2		REC93332-00005		REC93306-00501
F15A E F15A EH F15A EHS F15A EHL F15A EL	1998-00	REC93315-314V8		REC93341-41414	REC93315-317U2		REC93332-00005		REC93306-00501
F15A EP	2001-06	REC93315-314V8		REC93341-41414	REC93315-317U2		REC93332-00005		REC93306-00501
F15A EPL	2001-06	REC93315-314V8		REC93341-41414	REC93315-317U2		REC93332-00005		REC93306-00501
F15A EPS	2001-06	REC93315-314V8		REC93341-41414	REC93315-317U2		REC93332-00005		REC93306-00501
F15A ES	2001-06	REC93315-314V8		REC93341-41414	REC93315-317U2		REC93332-00005		REC93306-00501
F15A MH	1998-00	REC93315-314V8		REC93341-41414	REC93315-317U2		REC93332-00005		REC93306-00501
F15A MHL	2001-06	REC93315-314V8		REC93341-41414	REC93315-317U2		REC93332-00005		REC93306-00501
F15A MHS	2001-06	REC93315-314V8		REC93341-41414	REC93315-317U2		REC93332-00005		REC93306-00501
20C	1985-93	REC93315-017U4			REC93315-22004		REC93332-00005		REC93306-00612
20C M	1990-97	REC93315-017U4			REC93315-22004		REC93332-00005		REC93306-00612
20C MH	1998	REC93315-017U4			REC93315-22004		REC93332-00005		REC93306-00612
20C MHL 20C MHS	2001-02	REC93315-017U4			REC93315-22004		REC93332-00005		REC93306-00612
20D	1988		REC93315-22004		REC93315-22004		REC93332-00005		REC93306-00612
20D MHOL 20D MHOS	2001-06		REC93315-22004		REC93315-22004		REC93332-00005		REC93306-00612
20D WOL 20D WOS	2001		REC93315-22004		REC93315-22004		REC93332-00005		REC93306-00612
F20A	1998-99	REC93315-220V7	REC93332-000W5		REC93315-22004		REC93332-00005		REC93306-00612
F20A E	2000		REC93332-000W5		REC93315-22004		REC93332-00005		REC93306-00612
F20A EH	2000	REC93315-220V7	REC93332-000W5		REC93315-22004		REC93332-00005		REC93306-00612
F20A EHS	2001	REC93315-220V7			REC93315-22004		REC93332-00005		REC93306-00612
F20A EL	2001	REC93315-220V7	REC93332-000W5		REC93315-22004		REC93332-00005		REC93306-00612
F20A ES	2001-06	REC93315-220V7	REC93332-000W5		REC93315-22004		REC93332-00005		REC93306-00612
F20A ET	2000	REC93315-220V7	REC93332-000W5		REC93315-22004		REC93332-00005		REC93306-00612
F20A ETL	2003-06	REC93315-220V7	REC93332-000W5		REC93315-22004		REC93332-00005		REC93306-00612
F20A MH F20A MHL	2000	REC93315-220V7	REC93332-000W5		REC93315-22004		REC93332-00005		REC93306-00612
F20A MHS	2001	REC93315-220V7	REC93332-000W5		REC93315-22004		REC93332-00005		REC93306-00612
25B	1994-95	REC93315-325V1	REC93332-00001		REC93317-22204		REC93332-000W7		REC93306-00702
25B MHL 25B MHS	2001-06	REC93315-220V7	REC93332-000W5		REC93315-22004		REC93332-00005		REC93306-00612
25B WCS	2001-02	REC93315-220V7	REC93332-000W5		REC93315-22004		REC93332-00005		REC93306-00612
25D	1985-87	REC93315-017U4			REC93315-22004		REC93332-00005		REC93306-00612
25D M	1990-97	REC93315-017U4			REC93315-22004		REC93332-00005		REC93306-00612
25D MH	1998	REC93315-017U4			REC93315-22004		REC93332-00005		REC93306-00612
25D MHL 25D MHS	2001	REC93315-017U4			REC93315-22004		REC93332-00005		REC93306-00612
25J	1987-91	REC93315-220V7	REC93332-00023		REC93315-22004				REC93306-00612
25J	1992-00		REC93332-00001						REC93306-00612
25N	1988		REC93315-22004		REC93315-22004		REC93332-00005		REC93306-00612
25N MHOL 25N MHOS	2001-06		REC93315-22004		REC93315-22004		REC93332-00005		REC93306-00612
25N WOL	2001-03		REC93315-22004		REC93315-22004		REC93332-00005		REC93306-00612
25N WOS	2001-03				REC93315-22004		REC93332-00005		REC93306-00612
25Q	1988-91	REC93315-32224	REC93332-00023						REC93306-00612
25Q	1990-94	REC93315-32224	REC93332-00001		REC93317-22204				REC93306-00702
25V	1996-98	REC93315-220V7	REC93332-000W5		REC93315-22004		REC93332-00005		REC93306-00612
25V MHL 25V MHS 25V WVS	2001	REC93315-220V7	REC93332-000W5		REC93315-22004		REC93332-00005		REC93306-00612
F25A E F25A EH	2000	REC93315-220V7	REC93332-000W5		REC93315-22004		REC93332-00005		REC93306-00612
F25A EHL	2001-02	REC93315-220V7	REC93332-000W5		REC93315-22004		REC93332-00005		REC93306-00612
F25A EHS	2001	REC93315-220V7	REC93332-000W5		REC93315-22004		REC93332-00005		REC93306-00612
F25A EL F25A ES	2001-06	REC93315-220V7	REC93332-000W5		REC93315-22004		REC93332-00005		REC93306-00612
F25A ET	2000	REC93315-220V7	REC93332-000W5		REC93315-22004		REC93332-00005		REC93306-00612
F25A ETL	2001-06	REC93315-220V7	REC93332-000W5		REC93317-22204		REC93332-00005		REC93306-00612
F25A MH	2000	REC93315-220V7	REC93332-000W5		REC93315-22004		REC93332-00005		REC93306-00612
F25A MHL F25A MHS	2001-06	REC93315-220V7	REC93332-000W5		REC93315-22004		REC93332-00005		REC93306-00612
FT25B ED	2000	REC93315-32224	REC93332-00001		REC93317-22204		REC93332-00003		REC93306-001U1
FT25B EDL FT25B EDX	2001-02	REC93315-32224	REC93332-00001		REC93317-22204		REC93332-00003		REC93306-001U1

		1	2	3	4	5	6	7	8
FT25B ET	2000	REC93315-32224	REC93332-00001		REC93317-22204		REC93332-00003		REC93306-001U1
FT25B ETL	2001-06	REC93315-32224	REC93332-00001		REC93317-22204		REC93332-00003		REC93306-001U1
FT25B ETX	2001-02	REC93315-32224	REC93332-00001		REC93317-22204		REC93332-00003		REC93306-001U1
30A	1985	REC93315-017U4			REC93315-22004		REC93332-00005		REC93306-00612
30A M	1990-92	REC93315-017U4		REC93315-22004	REC93315-22004		REC93332-00005		REC93306-00612
30D	1986-00	REC93315-220V7	REC93332-00023		REC93315-22004				REC93306-00612
30D EOL									
30D EOL	2001-06	REC93315-220V7	REC93332-00001		REC93315-22004				REC93306-00612
30D ETOL									
30D MHOL									
30D MHOS	2001-06	REC93315-220V7	REC93332-00001		REC93315-22004				REC93306-00612
30D OL	2001-03		REC93332-00001		REC93315-22004				REC93306-00612
30D EOS	2001-06		REC93332-00001		REC93315-22004				REC93306-00612
30G	1996-98	REC93315-220V7	REC93332-000W5		REC93315-22004		REC93332-00005		REC93306-00612
30G MHS									
30G WCS	2001	REC93315-220V7	REC93332-000W5		REC93315-22004		REC93332-00005		REC93306-00612
30H MHS									
30H WCS	2001-02	REC93315-220V7	REC93332-000W5		REC93315-22004		REC93332-00005		REC93306-00612
F30A ETL									
F30A ETS	2001-06	REC93315-32224	REC93332-00001		REC93317-22204		REC93332-00003		REC93306-001U1
F30A MHDL									
F30A MHDS	2001-06	REC93315-32224	REC93332-00001		REC93317-22204		REC93332-00003		REC93306-001U1
40G WH	2003	REC93315-324U1	REC93315-217U0	REC93390-000U0			REC93332-000U0		
40H	1985-90	REC93315-32224	REC93332-00023		REC93317-22204				REC93306-00702
40H	1991-93	REC93315-32224	REC93332-00001		REC93317-22204				REC93306-00702
40Q	1993	REC93315-32224	REC93332-00001		REC93317-22204		REC93332-00003		REC93306-00702
40Q E	1992	REC93315-32224	REC93332-00023		REC93317-22204		REC93332-00003		REC93306-00702
40Q M	1990	REC93315-32224	REC93332-00023		REC93317-22204		REC93332-00003		REC93306-00702
40R MHO	2000	REC93315-32224	REC93332-00001		REC93317-22204		REC93332-00003		REC93306-001U1
40R ROS	2001	REC93315-32224	REC93332-00001		REC93317-22204		REC93332-00003		REC93306-001U1
40V	1995-98	REC93315-32224	REC93332-00001		REC93317-22204		REC93332-00003		REC93306-001U1
40V EO	2000	REC93315-32224	REC93332-00001		REC93317-22204		REC93332-00003		REC93306-001U1
40V EOL									
40V EOS	2001-06	REC93315-32224	REC93332-00001		REC93317-22204		REC93332-00003		REC93306-001U1
40V ETO	2000	REC93315-32224	REC93332-00001		REC93317-22204		REC93332-00003		REC93306-001U1
40V ETOL									
40V ETOS	2001-03	REC93315-32224	REC93332-00001		REC93317-22204		REC93332-00003		REC93306-001U1
40V MHOL									
40V MHOS	2001-06	REC93315-32224	REC93332-00001		REC93317-22204		REC93332-00003		REC93306-001U1
40V MO	2000	REC93315-32224	REC93332-00001		REC93317-22204		REC93332-00003		REC93306-001U1
40X	1998	REC93315-32224	REC93332-00001		REC93317-22204		REC93332-00003		REC93306-001U1
40X MH	2000	REC93315-32224	REC93332-00001		REC93317-22204		REC93332-00003		REC93306-001U1
40X MHL	2001-06	REC93315-32224	REC93332-00001		REC93317-22204		REC93332-00003		REC93306-001U1
40X MHS	2001-02	REC93315-32224	REC93332-00001		REC93317-22204		REC93332-00003		REC93306-001U1
40X W	2000	REC93315-32224	REC93332-00001		REC93317-22204		REC93332-00003		REC93306-001U1
40X WL									
40X WS	2001	REC93315-32224	REC93332-00001		REC93317-22204		REC93332-00003		REC93306-001U1
40X WT	2000		REC93332-00001		REC93317-22204		REC93332-00003		REC93306-001U1
40X WTL	2001-03	REC93315-32224	REC93332-00001		REC93317-22204		REC93332-00003		REC93306-001U1
40Y ETOL	2001-06	REC93315-32224	REC93332-00001		REC93317-22204		REC93332-00003		REC93306-001U1
40Y MHOS	2001-06	REC93315-32224	REC93332-00001		REC93317-22204		REC93332-00003		REC93306-001U1
E40G MH	2003	REC93315-324U1	REC93315-217U0	REC93390-000U0			REC93332-000U0		REC93332-000U0
E40G MHL	2003	REC93315-324U1	REC93315-217U0	REC93390-000U0			REC93332-000U0		REC93332-000U0
E40G MHS	2003	REC93315-324U1	REC93315-217U0	REC93390-000U0			REC93332-000U0		REC93332-000U0
F40A									
F40A ED	1999	REC93315-32224	REC93332-00001		REC93317-22204		REC93332-00003		REC93306-001U1
F40A EDL	2001	REC93315-32224	REC93332-00001		REC93317-22204		REC93332-00003		REC93306-001U1
F40A ET	1999	REC93315-32224	REC93332-00001		REC93317-22204		REC93332-00003		REC93306-001U1
F40A ETL	2001-02	REC93315-32224	REC93332-00001		REC93317-22204		REC93332-00003		REC93306-001U1
F40A ED	1999	REC93315-325V1	REC93332-00001		REC93317-22204		REC93332-00003		REC93306-207U0
F40B ED	2000-01	REC93315-32224	REC93332-00001		REC93317-22204		REC93332-00003		REC93306-001U1
F40B EDL	2001-06	REC93315-32224	REC93332-00001		REC93317-22204		REC93332-00003		REC93306-001U1
F40B EDS	2001-02	REC93315-32224	REC93332-00001		REC93317-22204		REC93332-00003		REC93306-001U1
F40B ET	2000-01	REC93315-32224	REC93332-00001		REC93317-22204		REC93332-00003		REC93306-001U1
F40B ETL									
F40B ETS	2001-06	REC93315-32224	REC93332-00001		REC93317-22204		REC93332-00003		REC93306-001U1
F40B MHD	2000	REC93315-32224	REC93332-00001		REC93317-22204		REC93332-00003		REC93306-001U1
F40B MHDL									
F40B MHDS	2001-06	REC93315-32224	REC93332-00001		REC93317-22204		REC93332-00003		REC93306-001U1
F40C ETL	2002-06	REC93315-32224	REC93332-00001		REC93317-22204				
F45A	1996-99	REC93315-32224	REC93332-00001		REC93317-22204		REC93332-000W7		REC93306-001U1
F45A ED									
F45A ET	2000	REC93315-32224	REC93332-00001		REC93317-22204		REC93332-000W7		REC93306-001U1
50D	1984-90	REC93315-32224	REC93332-00023		REC93317-22204				REC93306-00702
50D	1991-93	REC93315-32224	REC93332-00001						REC93306-00702
50G	1993-98	REC93315-325V1	REC93332-00001		REC93317-22204		REC93332-000W7		REC93306-00702
50G ETO	2000	REC93315-325V1	REC93332-00001		REC93317-22204		REC93332-00003		REC93306-00702
50G ETOL	2001-06	REC93315-325V1	REC93332-00001		REC93317-22204		REC93332-00003		REC93306-00702

		1	2	3	4	5	6	7	8
50H	1995-98	REC93315-32224	REC93332-00001		REC93317-22204		REC93332-00003		REC93306-001U1
50H EDO	2000	REC93315-32224	REC93332-00001		REC93317-22204		REC93332-00003		REC93306-001U1
50H EDOL	2001-02	REC93315-32224	REC93332-00001		REC93317-22204		REC93332-00003		REC93306-001U1
50H EDOS									
50H MDO	2000	REC93315-32224	REC93332-00001		REC93317-22204		REC93332-00003		REC93306-001U1
50H MO									
F50A	1995	REC93315-32224	REC93332-000U3		REC93317-22204		REC93332-00003		REC93306-001U1
F50A ED	2000	REC93315-32224	REC93332-00001	06	REC93317-22204		REC93332-00003		REC93306-001U1
F50A EDL	2001-06	REC93315-32224	REC93332-00001		REC93317-22204		REC93332-00003		REC93306-001U1
F50A ET	2000	REC93315-32224	REC93332-00001		REC93317-22204		REC93332-00003		REC93306-001U1
F50A ETL	2001-06	REC93315-32224	REC93332-00001		REC93317-22204		REC93332-00003		REC93306-001U1
F50B	1996-97	REC93315-32224	REC93332-00001		REC93317-22204		REC93332-00003		REC93306-001U1
F50B	1998-99	REC93315-325V1	REC93332-000U3		REC93317-22204		REC93332-000W7		REC93306-001U1
F50B ET	2000	REC93315-32224	REC93332-00001		REC93317-22204		REC93332-00003		REC93306-001U1
F50F EDL	2005-06	REC93315-32224	REC93332-00001		REC93317-22204				REC93306-001U1
F50F ETL									
FT50B	1998-99	REC93315-32224	REC93332-00001		REC93317-22204		REC93332-000W7		REC93306-001U1
FT50B ETL	2001-02	REC93315-32224	REC93332-00001		REC93317-22204		REC93332-00003		REC93306-001U1
FT50C ETL	2002-06	REC93315-32224	REC93332-00001		REC93317-22204		REC93332-00003		REC93306-001U1
FT50G ETL	2005-06		REC93332-000U3		REC93317-325U0				REC93306-001U1
55B	1993-98	REC93315-32224	REC93332-00001		REC93317-22204		REC93332-00003		REC93306-00702
55B E	1990-91	REC93315-32224	REC93332-00001		REC93317-22204		REC93332-00003		REC93306-00702
55B E	1992	REC93315-32224	REC93332-00023		REC93317-22204		REC93332-00003		REC93306-00702
55B EHD	2000	REC93315-32224	REC93332-00001		REC93317-22204		REC93332-00003		REC93306-00702
55B ET	2000	REC93315-32224	REC93332-00001		REC93317-22204		REC93332-00003		REC93306-00702
55B ETL	2001-02	REC93315-32224	REC93332-00001		REC93317-22204	-06	REC93332-00003		REC93306-00702
60F	1984-98	REC93315-325V1	REC93332-00001		REC93317-22204		REC93332-000W7		REC93306-00702
60F EO									
60F ETO	2000	REC93315-325V1	REC93332-00001		REC93317-22204		REC93332-00003		REC93306-00702
60F ETOL	2001-06	REC93315-325V1	REC93332-00001		REC93317-22204		REC93332-00003		REC93306-00702
E60H MHDL	2001-06	REC93315-325V1	REC93332-000U3		REC93317-325U0		REC93332-000W7		REC93306-207U0
F60A ETL	2002-06	REC93315-32224	REC93332-00001		REC93317-22204				REC93306-001U1
F60C ETL	2005-06	REC93315-32224	REC93332-00001		REC93317-22204				REC93306-001U1
FT60B ETL	2003-06		REC93332-000U3		REC93317-325U0				REC93306-207U0
FT60D ETL	2005-06		REC93332-000U3		REC93317-325U0				REC93306-207U0
70B	1984-98	REC93315-325V1	REC93332-00001		REC93317-22204		REC93332-000W7		REC93306-00702
70B EDOL	2001	REC93315-325V1	REC93332-00001		REC93317-22204		REC93332-00003		REC93306-00702
70B EO									
70B ETO	2000	REC93315-325V1	REC93332-00001		REC93317-22204		REC93332-00003		REC93306-00702
70B ETOL	2001-06	REC93315-325V1	REC93332-00001		REC93317-22204		REC93332-00003		REC93306-00702
75A	1990-98	REC93315-325V1	REC93332-000U3		REC93317-325U0		REC93332-000W7		REC93306-207U0
75A E	1990-00	REC93315-325V1	REC93332-000U3		REC93317-325U0		REC93332-000U5		REC93306-207U0
75A EDL	2001-06	REC93315-325V1	REC93332-000U3		REC93317-325U0		REC93332-000W7		REC93306-207U0
75A EM	1992-93		REC93332-000U3		REC93317-325U0		REC93332-000U5		REC93306-207U0
75A ET	2000	REC93315-325V1			REC93317-325U0		REC93332-000U5		REC93306-207U0
75A ETL	2001-02	REC93315-325V1	REC93332-000U3		REC93317-325U0		REC93332-000W7		REC93306-207U0
75A MHD	2000	REC93315-325V1	REC93332-000U3		REC93317-325U0				REC93306-207U0
75C	1998	REC93315-325V1			REC93317-325U0		REC93332-000W7		REC93306-207U0
75C ETO	2000	REC93315-325V1	REC93332-000U3		REC93317-325U0		REC93332-000W7		REC93306-207U0
75C ETOL	2001-06	REC93315-325V1	REC93332-000U3		REC93317-325U0		REC93332-000W7		REC93306-207U0
80A	1985-96	REC93315-325V1	REC93332-000U3		REC93317-325U0		REC93332-000U5		REC93306-207U0
F80A	1999		REC93332-000U3		REC93317-325U0	REC93317-322V0			REC93306-207U0
F80A ET	2000		REC93332-000U3		REC93317-325U0	REC93317-322V0			REC93306-207U0
F80A ETL	2001-06		REC93332-000U3		REC93317-325U0	REC93317-322V0			REC93306-207U0
F80A ETX	2001		REC93332-000U3		REC93317-325U0	REC93317-322V0			REC93306-207U0
F80B ETL	2005-06		REC93332-000U3		REC93317-325U0	REC93317-322V0			REC93306-207U0
85A	1996-98	REC93315-325V1	REC93332-000U3		REC93317-325U0		REC93332-000W7		REC93306-207U0
85A E	1990-00	REC93315-325V1	REC93332-000U3		REC93317-325U0		REC93332-000U5		REC93306-207U0
85A ET	2000	REC93315-325V1	REC93332-000U3		REC93317-325U0		REC93332-000U5		REC93306-207U0
85A ETL	2001-02	REC93315-325V1	REC93332-000U3		REC93317-325U0		REC93332-000W7		REC93306-207U0
90A	1984-98	REC93315-325V1	REC93332-000U3		REC93317-325U0		REC93332-000W7		REC93306-207U0
90A ETO	2000	REC93315-325V1	REC93332-000U3		REC93317-325U0		REC93332-000U7		REC93306-207U0
90A ETOL	2001-06	REC93315-325V1	REC93332-000U3		REC93317-325U0		REC93332-000W7		REC93306-207U0
100A	1998	REC93315-628U9	REC93315-430V5 REC93341-930V2		REC93315-430U8	REC93315-425U7	REC93332-000U7		REC93306-208U0
100A ETO	2000	REC93315-628U9	REC93317-330U2 REC93341-930V2		REC93315-430U8	REC93315-425U7			REC93306-208U0
100A ETOL	2001	REC93315-628U9	REC93317-330U2 REC93341-930V2		REC93315-430U8	REC93315-425U7	REC93332-000U7		REC93306-208U0
F100A	1999		REC93332-000U3		REC93317-325U0	REC93317-322V0			REC93306-207U0
F100A ET	2000		REC93332-000U3		REC93317-325U0	REC93317-322V0			REC93306-207U0
F100A ETL	2001-06		REC93332-000U3		REC93317-325U0	REC93317-322V0			REC93306-207U0
F100A ETX	2001		REC93332-000U3		REC93317-325U0	REC93317-322V0			REC93306-207U0

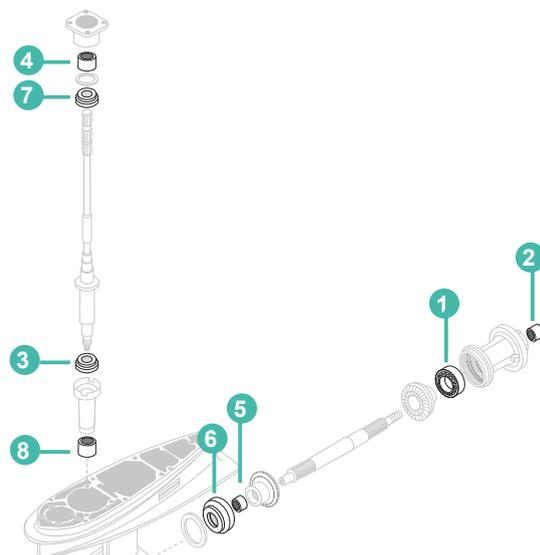

		1	2	3	4	5	6	7	8
F100B ETX	2005-06	REC93315-628U9	REC93317-330U2 REC93341-930V2		REC93315-430U8	REC93315-425U7	REC93332-000U7		REC93306-208U0
F100D ETL	2005-06		REC93332-000U3		REC93317-325U0	REC93317-322V0			REC93306-207U0
115A	1984-87	REC93315-628U9	REC93317-330U2 REC93341-930V2		REC93315-430U8	REC93315-425U7	REC93332-000U7		REC93306-208U0
115B	1988-95	REC93315-628U9	REC93317-330U2 REC93341-930V2		REC93315-430U8	REC93315-425U7	REC93332-000U7		REC93306-208U0
115B	1996	REC93315-628U9	REC93315-430V5 REC93341-930V2		REC93315-430U8	REC93315-425U7	REC93332-000U7		REC93306-208U0
115B ETO	1997-98	REC93315-628U9	REC93315-430V5 REC93341-930V2		REC93315-430U8	REC93315-425U7	REC93332-000U7		REC93306-208U0
115B ETO	1999-00	REC93315-628U9	REC93317-330U2			REC93315-425U7	REC93332-000U7		REC93306-208U0
115B ETOL	2001-02	REC93315-628U9	REC93317-330U2 REC93341-930V2		REC93315-430U8	REC93315-425U7	REC93332-000U7		REC93306-208U0
115C	1990-95	REC93315-628U9	REC93317-330U2 REC93341-930V2		REC93315-430U8	REC93315-425U7	REC93332-000U7	REC93315-430V5	REC93306-208U0
115C ETO	2000	REC93315-628U9	REC93317-330U2 REC93341-930V2		REC93315-430U8	REC93315-425U7	REC93332-000U7	REC93315-430V5	REC93306-208U0
115C ETOL	2001-06	REC93315-628U9	REC93317-330U2 REC93341-930V2		REC93315-43061	REC93315-425U7	REC93332-000U7	REC93315-430V5	REC93306-208U0
115C ETOX	2001-02	REC93315-628U9	REC93317-330U2 REC93341-930V2		REC93315-430U8	REC93315-425U7	REC93332-000U7	REC93315-430V5	REC93306-208U0
F115A ET	2000	REC93315-628U9	REC93317-330U2 REC93341-930V2		REC93315-430U8	REC93315-425U7	REC93332-000U7	REC93315-430V5	REC93306-208U0
F115A ETL F115A ETX	2001-06	REC93315-628U9	REC93317-330U2 REC93341-930V2		REC93315-430U8	REC93315-425U7	REC93332-000U7	REC93315-430V5	REC93306-208U0
FL115A ET	2000	REC93315-628U9	REC93317-330U2 REC93341-930V2		REC93315-430U8	REC93315-425U7	REC93332-000U7	REC93315-430V5	REC93306-208U0
FL115A ETX	2001-06	REC93315-628U9	REC93317-330U2 REC93341-930V2		REC93315-430U8	REC93315-425U7	REC93332-000U7	REC93315-430V5	REC93306-208U0
130B	1990-94	REC93315-628U9	REC93317-330U2 REC93341-930V2		REC93315-430U8	REC93315-425U7	REC93332-000U7	REC93315-430V5	REC93306-208U0
130B ETO	2000	REC93315-628U9	REC93317-330U2 REC93341-930V2		REC93315-430U8	REC93315-425U7	REC93332-000U7	REC93315-430V5	REC93306-208U0
130B ETOL	2001-06	REC93315-628U9	REC93317-330U2 REC93341-930V2		REC93315-43061	REC93315-425U7	REC93332-000U7	REC93315-430V5	REC93306-208U0
130B ETOX	2001	REC93315-628U9	REC93317-330U2 REC93341-930V2		REC93315-430U8	REC93315-425U7	REC93332-000U7	REC93315-430V5	REC93306-208U0
L130B	1991-94	REC93315-628U9	REC93317-330U2 REC93341-930V2		REC93315-430U8	REC93315-425U7	REC93332-000U7	REC93315-430V5	REC93306-208U0
L130B	1995-98	REC93315-628U9	REC93315-430V5 REC93341-930V2		REC93315-430U8	REC93315-425U7	REC93332-000U7		REC93306-208U0
L130B ETO	2000	REC93315-628U9	REC93317-330U2 REC93341-930V2		REC93315-430U8	REC93315-425U7	REC93332-000U7	REC93315-430V5	REC93306-208U0
L130B ETOX	2001	REC93315-628U9	REC93317-330U2 REC93341-930V2		REC93315-43061	REC93315-425U7	REC93332-000U7	REC93315-430V5	REC93306-208U0
140A	1984-87	REC93315-628U9	REC93317-330U2 REC93341-930V2		REC93315-430U8	REC93315-425U7	REC93332-000U7		REC93306-208U0
140B	1988-89	REC93315-628U9	REC93317-330U2 REC93341-930V2		REC93315-430U8	REC93315-425U7	REC93332-000U7		REC93306-208U0
L140B	1989	REC93315-628U9	REC93317-330U2 REC93341-930V2		REC93315-430U8	REC93315-425U7	REC93332-000U7	REC93315-430V5	REC93306-208U0
150A	1984-89	REC93311-928U5	REC93317-330U2 REC93341-930V2		REC93315-430U8	REC93315-425V3	REC93332-000V3 STD. ROT REC93390-000U2 C.ROT.	REC93315-430V5	REC93306-209U0 STD. ROT REC93332-00048 C.ROT.
150A ET	1998-00	REC93311-928U5	REC93317-330U2 REC93341-930V2		REC93315-430U8	REC93315-425V3	REC93332-000V3		REC93306-209U0
150A ETO	1986-87				REC93315-430U8		REC93390-000U2		REC93390-000U2
150A ETL	2001-02	REC93311-928U5	REC93317-330U2 REC93341-930V2		REC93315-430U8	REC93315-425V3	REC93332-000V3		REC93306-209U0
150A ETX	2001-02	REC93311-928U5	REC93317-330U2 REC93341-930V2		REC93315-430U8	REC93315-425V3	REC93332-000V3		REC93306-209U0
150C	1990-94	REC93311-928U5	REC93317-330U2 REC93341-930V2		REC93315-430U8	REC93315-425V3	REC93332-000V3		REC93306-209U0
150F	1996-98	REC93311-928U5	REC93315-430V5 REC93341-930V2		REC93315-430U8	REC93315-425V3	REC93390-000U2		REC93332-00048
150F	1997-98	REC93311-928U5	REC93315-430V5 REC93341-930V2		REC93315-430U8	REC93315-425V3	REC93332-000V3 STD. ROT REC93390-000U2 C.ROT.		REC93306-209U0 STD. ROT REC93332-00048 C.ROT.





		1	2	3	4	5	6	7	8
200B	1990-94	REC93311-928U5	REC93317-330U2 REC93341-930V2		REC93315-430U8	REC93315-425V3	REC93332-000V3		REC93306-209U0
200B	1995	REC93311-928U5	REC93315-430V5		REC93315-430U8	REC93315-425V3	REC93390-000U2 REC93332-000V3		REC93332-00048 REC93306-209U0
200F	1996-98	REC93311-928U5	REC93315-430V5 REC93341-930V2		REC93315-430U8	REC93315-425V3	STD. ROT REC93390-000U2 C.ROT.		STD. ROT REC93332-00048 C.ROT.
200F ETO	2000	REC93311-928U5	REC93317-330U2 REC93341-930V2		REC93315-430U8	REC93315-425V3	REC93332-000V3 STD. ROT REC93390-000U2 C.ROT.		REC93306-209U0 STD. ROT REC93332-00048 C.ROT.
200F ETOL 200F ETOX	2001-06	REC93311-928U5	REC93317-330U2 REC93341-930V2		REC93315-43061	REC93315-425V3	REC93332-000V3 STD. ROT REC93390-000U2 C.ROT.		REC93306-209U0 STD. ROT REC93332-00048 C.ROT.
200G	1999	REC93311-928U5	REC93317-330U2 REC93341-930V2		REC93315-430U8	REC93315-425V3	REC93332-000V3		REC93306-209U0
200G ETO	2000	REC93311-928U5	REC93317-330U2 REC93341-930V2		REC93315-430U8	REC93315-425V3	REC93332-000V3		REC93306-209U0
200G ETOL	2001-03	REC93311-928U5	REC93317-330U2 REC93341-930V2		REC93315-430U8	REC93315-425V3	REC93332-000V3		REC93306-209U0
F200A ETX	2002-06	REC93311-83280	REC93317-330U2		REC93315-43061		REC93332-000W1		REC93306-209U0 STD. ROT REC93332-00048 C.ROT.
F200C ETX	2006	REC93311-83280	REC93317-330U2				REC93332-000W1		REC93306-209U0 STD. ROT REC93332-00048 C.ROT.
FL200A ETX	2002-06	REC93311-83280	REC93317-330U2		REC93315-43061		REC93332-000W1		REC93306-209U0 STD. ROT REC93332-00048 C.ROT.
FL200C ETX	2006	REC93311-83280	REC93317-330U2				REC93332-000W1		REC93306-209U0 STD. ROT REC93332-00048 C.ROT.
L200A	1988-89	REC93311-928U5	REC93317-330U2 REC93341-930V2		REC93315-430U8	REC93315-425V3	REC93390-000U2	REC93315-430V5	REC93332-00048
L200B	1990-94	REC93311-928U5	REC93317-330U2 REC93341-930V2			REC93315-425V3	REC93332-000V3 STD. ROT REC93390-000U2 C.ROT.	REC93315-430V5	REC93306-209U0
L200F	1996-98	REC93311-928U5	REC93315-430V5 REC93341-930V2		REC93315-430U8	REC93315-425V3	REC93332-000V3 STD. ROT REC93390-000U2 C.ROT.		REC93306-209U0 STD. ROT REC93332-00048 C.ROT.
L200F ETO	2000	REC93311-928U5	REC93317-330U2 REC93341-930V2		REC93315-430U8	REC93315-425V3	REC93332-000V3 STD. ROT REC93390-000U2 C.ROT.		REC93306-209U0 STD. ROT REC93332-00048 C.ROT.
L200F ETOL	2001-06	REC93311-928U5	REC93317-330U2 REC93341-930V2		REC93315-43061	REC93315-425V3	REC93332-000V3 STD. ROT REC93390-000U2 C.ROT.		REC93306-209U0 STD. ROT REC93332-00048 C.ROT.
L200F ETOX	2001	REC93311-928U5	REC93317-330U2		REC93315-430U8	REC93315-425V3	REC93332-000V3 STD. ROT REC93390-000U2 C.ROT.		REC93306-209U0 STD. ROT REC93332-00048 C.ROT.
LZ200N	2000						REC93390-000U2		REC93390-000U2
LZ200N ETO	2000	REC93311-928U5	REC93317-330U2		REC93315-430U8	REC93315-425V3	REC93332-000V3		REC93306-209U0 STD. ROT REC93332-00048 C.ROT.
LZ200N ETOX	2001-07	REC93311-928U5	REC93317-330U2 REC93341-930V2		REC93315-43061	REC93315-425V3	REC93332-000V3 STD. ROT REC93390-000U2 C.ROT.		REC93306-209U0 STD. ROT REC93332-00048 C.ROT.
LZ200T R	2005						REC93390-000U2		REC93390-000U2
LZ200T XRC	2004-06						REC93390-000U2		REC93390-000U2
LZ200T XRD	2005						REC93390-000U2		REC93390-000U2
Z200N ETO	2000	REC93311-928U5	REC93317-330U2 REC93341-930V2		REC93315-430U8	REC93315-425V3	REC93332-000V3		REC93306-209U0 STD. ROT REC93332-00048 C.ROT.
Z200N ETOL Z200N ETOX	2001-06	REC93311-928U5	REC93317-330U2 REC93341-930V2		REC93315-43061	REC93315-425V3	REC93332-000V3 STD. ROT REC93390-000U2 C.ROT.		REC93306-209U0 STD. ROT REC93332-00048 C.ROT.
Z200P ETOL	2003-06	REC93311-928U5	REC93317-330U2 REC93341-930V2		REC93315-43061	REC93315-425V3	REC93332-000V3		REC93306-209U0
220A	1984-86	REC93311-928U5	REC93317-330U2 REC93341-930V2		REC93315-430U8	REC93315-425V3	REC93332-000V3		REC93306-209U0
225A	1987-89	REC93311-928U5	REC93317-330U2 REC93341-930V2		REC93315-430U8	REC93315-425V3			REC93306-209U0
225B	1990-94	REC93311-928U5	REC93317-330U2 REC93341-930V2		REC93315-430U8	REC93315-425V3	REC93332-000V3		REC93306-209U0
225B	1995	REC93311-928U5	REC93315-430V5			REC93315-425V3	REC93332-000V3		REC93306-209U0
225C	1994	REC93311-83280	REC93317-330U2		REC93315-430U8		REC93332-000W1		REC93306-210U0

		1	2	3	4	5	6	7	8
225C	1995	REC93311-83280	REC93315-430V5						
225D	1996-98	REC93311-928U5	REC93315-430V5 REC93341-930V2		REC93315-430U8	REC93315-425V3	REC93332-000V3		REC93306-209U0
225D ETO	2000	REC93311-928U5	REC93317-330U2 REC93341-930V2		REC93315-430U8	REC93315-425V3	REC93332-000V3		REC93306-209U0
225D ETOL 225D ETOX	2001-03	REC93311-928U5	REC93317-330U2 REC93341-930V2		REC93315-430U8	REC93315-425V3	REC93332-000V3		REC93306-209U0
225G	1999	REC93311-83280	REC93317-330U2		REC93315-43061		REC93332-000W1		REC93306-210U0
225G ETO	2000	REC93311-83280	REC93317-330U2		REC93315-43061		REC93332-000W1		REC93306-210U0
225G ETOL	2001-03	REC93311-928U5	REC93317-330U2		REC93315-43061		REC93332-000W1		REC93306-210U0 REC93306-209U0 STD. ROT REC93332-00048 C.ROT.
F225A ETU	2003-06		REC93317-330U2		REC93315-43061		REC93332-000W1		REC93306-210U0 STD. ROT REC93332-00048 C.ROT.
F225A ETX FL225A ETX	2002-06	REC93311-83280	REC93317-330U2		REC93315-43061		REC93332-000W1		REC93306-210U0 STD. ROT REC93332-00048 C.ROT.
L225C	1994	REC93311-83280	REC93317-330U2		REC93315-430U8		REC93332-000W1		REC93306-210U0
L225C	1995	REC93311-83280	REC93315-430V5				REC93332-000W1		REC93306-210U0
250A	1990-94	REC93311-83280	REC93317-330U2		REC93315-430U8		REC93332-000W1		REC93306-210U0
250A	1995-98	REC93311-83280	REC93315-430V5				REC93332-000W1		REC93306-210U0
250A ETO	2000	REC93311-83280	REC93317-330U2		REC93315-430U8		REC93332-000W1		REC93306-210U0
250A ETOX	2001-06	REC93311-83280	REC93317-330U2		REC93315-43061		REC93332-000W1		REC93306-210U0
250B	1997-98	REC93311-83280	REC93317-330U2		REC93315-430U8		REC93332-000W1		REC93306-210U0
250B ETO	2000	REC93311-83280	REC93317-330U2		REC93315-430U8		REC93332-000W1		REC93306-210U0
250B ETOX	2001-03	REC93311-83280	REC93317-330U2		REC93315-430U8		REC93332-000W1		REC93306-210U0
250G ETOX	2006	REC93311-83280	REC93317-330U2		REC93315-43061		REC93332-000W1		REC93306-210U0
F250A ETU	2006	REC93311-83280	REC93317-330U2				REC93332-000W1		REC93306-210U0 REC93306-209U0 STD. ROT REC93332-00048 C.ROT.
F250A ETX FL250A ETU FL250 ETX	2006	REC93311-83280	REC93317-330U2				REC93332-000W1		REC93306-210U0 REC93306-209U0 STD. ROT REC93332-00048 C.ROT.
L250A	1990-94	REC93311-83280	REC93317-330U2		REC93315-430U8		REC93332-000W1	REC93315-430U8	REC93315-430U8
L250A	1995-98	REC93311-83280	REC93315-430V5				REC93332-000W1		REC93306-210U0
L250A ETO	2000	REC93311-83280	REC93317-330U2		REC93315-430U8		REC93332-000W1		REC93306-210U0
L250A ETOX	2001-06	REC93311-83280	REC93317-330U2		REC93315-43061		REC93332-000W1		REC93306-210U0
L250B	1997-98	REC93311-83280	REC93317-330U2		REC93315-430U8		REC93332-000W1		REC93306-210U0
L250B ETO	2000	REC93311-83280	REC93317-330U2		REC93315-430U8		REC93332-000W1		REC93306-210U0
L250B ETOX	2001-03	REC93311-83280	REC93317-330U2		REC93315-430U8		REC93332-000W1		REC93306-210U0
L250G ETOX	2006	REC93311-83280	REC93317-330U2		REC93315-43061		REC93332-000W1		REC93306-210U0 REC93306-209U0 STD. ROT REC93332-00048 C.ROT.
LZ250D EOX	2003-06	REC93311-83280	REC93317-330U2		REC93315-43061		REC93332-000W1		REC93306-209U0 STD. ROT REC93332-00048 C.ROT.
Z250D ETOU	2003	REC93311-83280	REC93317-330U2		REC93315-43061		REC93332-000W1		REC93306-209U0 STD. ROT REC93332-00048 C.ROT.
Z250D ETOX Z250F ETOL	2003-06	REC93311-83280	REC93317-330U2		REC93315-43061		REC93332-000W1		REC93306-209U0 STD. ROT REC93332-00048 C.ROT.
LZ300A ETOX Z300A ETOU Z300A ETOX	2004-06	REC93311-83280	REC93317-330U2				REC93332-000W1		REC93306-209U0 STD. ROT REC93332-00048 C.ROT.

# SISTEMA DE PROPULSIÓN PROPULSION SYSTEM

# SISTEMA DI PROPULSIONE SYSTEME DE PROPULSION

HÉLICES ALUMINIO E INOXIDABLE DE 3 Y 4 PALAS    3 & 4 BLADE ALUMINIUM & SS PROPELLERS    ELICHE ALLUMINIO E INOX DA 3 E 4 PALE    HELICE ALUMINIUM ET INOX 3 ET 4 PALES

CÓDIGO DE REFERENCIAS    PART NO. CODING SYSTEM    SISTEMA DI CODICE    CODAGE DES REFERENCES

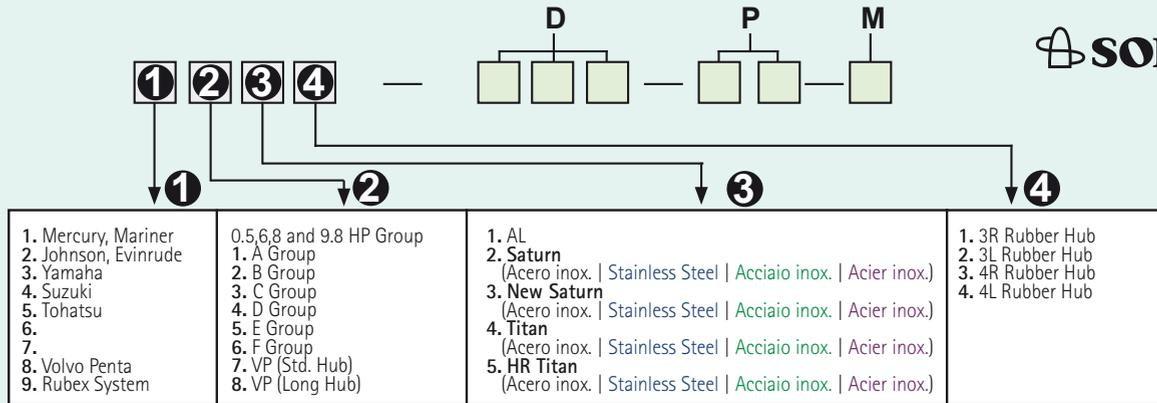

Ejemplo | Note | Esempio | Exemple

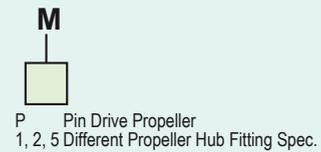
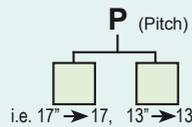
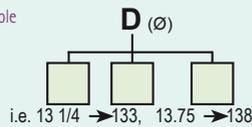

## AMITA 3

Hélice de aluminio de 3 palas con núcleo de goma de gran resistencia.

3 blade aluminum propeller with heavy duty rubber hub.

Eliche di alluminio a 3 pale con mozzi in gomma ad alta resistenza.

Hélice en aluminium 3 pales avec moyeu en caoutchouc



## AMITA 4

Hélices de aluminio de 4 palas con núcleo de goma de gran resistencia. Van muy suaves a poca velocidad y hace el barco muy manejable con la mar picada.

4 Blade aluminum propeller with heavy duty rubber hub. Smoother low speed makes the offshore boating activity much easier.

Eliche di alluminio a 4 pale con mozzo in gomma ad alta resistenza. Molto morbido a bassa velocità e rende la barca molto maneggevole con mare cattivo.

Hélice en aluminium 4 pales avec moyeu en caoutchouc. Permet d'aller doucement à basse vitesse et rend le bateau très maniable lorsque la mer est agitée



## LEXOR

Hélices de acero inoxidable de 3 palas. Gran diámetro del área de las palas para barcos pesados. Gran rendimiento en alta velocidad sin sacrificar las velocidades medias. Excelente ahorro de combustible.

Three blade stainless steel propeller. Large diameter and blade area for big boat loads. Great high speed performance without sacrificing mid-range speeds. Excellent fuel economy.

Eliche di acciaio inox a 3 pale. Grande diametro delle pale per imbarcazioni pesanti. Grandi prestazioni ad alta velocità senza sacrificare velocità medie. Eccellente risparmio di carburante.

Hélice inox 3 Pales, grand diamètre pour bateaux lourds. Excellentes performances à grande vitesse sans sacrifier les vitesses moyennes. Excellente économie de carburant.



## NEW SATURN

Hélices de acero inoxidable de 3 palas. Ofrece buena aceleración y rendimiento. Tamaño más pequeño que ofrece un diámetro extragrande.

Three blade stainless steel propeller. Offers good acceleration & all-round performance. Smaller pitch sizes offered in extra large diameter with increased blade area.

Eliche di acciaio inox a 3 pale. Buona accelerazione. Piccole dimensioni che offre un più grande diametro.

Hélice inox 3 pales, offrant de bonnes accélérations et performances. Taille de pas réduite pour les modèles de grands diamètres avec une surface de pale plus importante.



GUÍA DE HÉLICES CON NÚCLEO INTEGRADO		PROPELLERS APPLICATION WITH RUBBER HUB		GUIDA ELICHE CON MOZZO				GUIDE DES HELICES ET MOYEUX		INOX STAINLESS STEEL		
	2T STROKES	4T STROKES	R.O. OEM	A	G	B	D	P	R	AL		
2.5 - 6 HP	✓	✓	6L5-45949-00-EL	9		3	7 <sup>1/4</sup>	5	R	SOL3011-073-05S	AMITA 3	
			6E0-45943-01-EL				7 <sup>1/2</sup>	7	R	SOL3011-075-07S	AMITA 3	
			6L5-45943-00-EL				7 <sup>1/4</sup>	6	R	PAF2.6-03010000		
			6E0-45943-01-EL				7 <sup>1/2</sup>	7	R	PAF4-03070000		
6.8 HP F6, F8, F9.9	✓	✓	6G1-45947-00-EL	7		3	8 <sup>1/2</sup>	7	R	SOL3011-085-07	AMITA 3	
			6G1-45943-00-EL				8 <sup>1/2</sup>	8	R	SOL3011-085-08	AMITA 3	
			6G1-45941-00-EL				8 <sup>1/2</sup>	9	R	SOL3011-085-09	AMITA 3	
8 HP (1976-83)	✓		647-45943-00-EL	PIN		3	8 <sup>3/4</sup>	8	R	SOL2011-083-08P	AMITA 3	
							9	7	R	SOL3011-090-07-P	AMITA 3	
9.9 15 T8 T9.9 F9.9 (2000-07) F15 F20 Hight Thrust	✓	✓	683-45947-00-EL	8	2 1/2	3	9 <sup>1/4</sup>	7	R	SOL3111-093-07	AMITA 3	
			683-45945-00-EL				9 <sup>1/4</sup>	8	R	SOL3111-093-08	AMITA 3	
			683-45942-00-EL				9 <sup>1/4</sup>	9		SOL3111-093-09	AMITA 3	
			683-45943-00-EL				9 <sup>1/4</sup>	10	R	SOL3111-093-10	AMITA 3	
			63V-45943-10-00				9 <sup>1/4</sup>	11	R	SOL3111-093-11	AMITA 3	
			683-45941-00-00				9 <sup>1/4</sup>	11	R	PAF15-06090000		
			683-45941-00-00				9 <sup>1/4</sup>	12	R	SOL3111-093-12	AMITA 3	
20 (1996-97) 25 (1980 +) 30 (1979 +) F25	✓	✓	664-45941-01-EL	10	3	3	9 <sup>7/8</sup>	9	R	SOL3211-099-09		
			664-45945-00-EL				9 <sup>7/8</sup>	10	R	SOL3211-099-10		
			664-45947-01-EL				9 <sup>7/8</sup>	11	R	SOL3211-099-11		
			664-45954-00-EL				9 <sup>7/8</sup>	12	R	SOL3211-099-12		
			664-45949-02-EL				9 <sup>7/8</sup>	13	R	SOL3211-099-13		
			664-45972-00-98				10 <sup>3/4</sup>	10	R		SOL3231-108-10	NEW SATURN
			664-45970-00-98				10 <sup>1/2</sup>	11	R		SOL3231-105-11	NEW SATURN
MAR-6YT30-02-12	10 <sup>1/4</sup>	12	R		SOL3231-103-12	NEW SATURN						
						10 <sup>3/8</sup>	13	R		SOL3231-101-13	NEW SATURN	
40 48 50 (NO T50) 55 60 (-1991) F30 F40 (1999+) F50 (1995+) F60 (1999+)			663-45956-01-EL	13	3 1/2	3	12 <sup>1/4</sup>	9	R	SOL3311-121-09	AMITA 3	
			663-45947-02-EL				11 <sup>5/8</sup>	11	R	SOL3311-116-11	AMITA 3	
			663-45952-02-EL				11 <sup>3/4</sup>	12	R	SOL3311-114-12	AMITA 3	
			663-45945-02-EL				11 <sup>1/8</sup>	13	R	SOL3311-111-13	AMITA 3	
			69W-45941-00-EL				11 <sup>1/8</sup>	13	R	PAT40-04070000		
			663-45958-01-EL				11 <sup>1/4</sup>	14	R	SOL3311-111-14	AMITA 3	
			663-45943-02-EL				11	15	R	SOL3311-110-15	AMITA 3	
			663-45949-01-EL				10 <sup>3/4</sup>	16	R	SOL3311-110-16	AMITA 3	
			663-45941-01-EL				11	17	R	SOL3311-110-17	AMITA 3	
							11 <sup>7/8</sup>	10	R		SOL3331-119-10	NEW SATURN
							11 <sup>5/8</sup>	11	R		SOL3331-116-11	NEW SATURN
	11 <sup>3/8</sup>	12	R		SOL3331-114-12	NEW SATURN						
	11 <sup>1/8</sup>	13	R		SOL3331-111-13	NEW SATURN						
	11 <sup>1/8</sup>	14	R		SOL3331-111-14	NEW SATURN						
40 HP				PIN		3	11 <sup>1/2</sup>	10	R	SOL3311-115-10-P	AMITA 3	
							11 <sup>1/2</sup>	11	R	SOL3311-115-11-P	AMITA 3	
							11 <sup>1/2</sup>	12	R	SOL3311-115-12-P	AMITA 3	
60 (1992+) 70 (1984+) 75 (1994+) 80 (1978-89) 85 (1991-97) 90 (1984+) 115 (1984+) 130 (1984+) F75 (2003+) F80 (1999+) F90 (2003+) F100 (1999+) F115 (2000+) T50 (1996+) T60 (2003+) F70 (2010+)			6E5-45954-00-EL	15	4 1/4	3	14	11	R	SOL3411-140-11	AMITA 3	
			6E5-45949-00-EL				13 <sup>1/4</sup>	13	R	SOL3411-138-13	AMITA 3	
							13 <sup>3/8</sup>	13	L	SOL3412-138-13	AMITA 4	
			6E5-45947-00-EL				13 <sup>1/2</sup>	15	R	SOL3411-135-15	AMITA 3	
							13 <sup>1/2</sup>	15	L	SOL3413-130-15	AMITA 4	
							13 <sup>1/2</sup>	15	L	SOL3412-135-15		
			6E5-45945-00-EL				13 <sup>1/4</sup>	17	R	SOL3411-133-17	AMITA 3	
							13 <sup>1/4</sup>	17	L	SOL3413-128-17	AMITA 4	
							13 <sup>1/4</sup>	17	L	SOL3412-133-17		
			6E5-45941-00-EL				13	19	R	SOL3411-130-19	AMITA 3	
							13	19	R	SOL3413-125-19	AMITA 4	
			6E5-45943-00-EL				13	21	R	SOL3411-130-21	AMITA 3	
							13	21	R	SOL3413-125-21	AMITA 4	
			688-45978-60-98				13 <sup>1/2</sup>	15	R		SOL3431-135-15	NEW SATURN
			688-45930-02-98				13	17	R		SOL3431-133-17	NEW SATURN
	13	17	L		SOL3432-133-17	NEW SATURN						
688-45970-03-98	13	19	R		SOL3431-130-19	NEW SATURN						
	13	19	L		SOL3432-130-19	NEW SATURN						
688-45972-02-98	13	21	R		SOL3431-130-21	NEW SATURN						

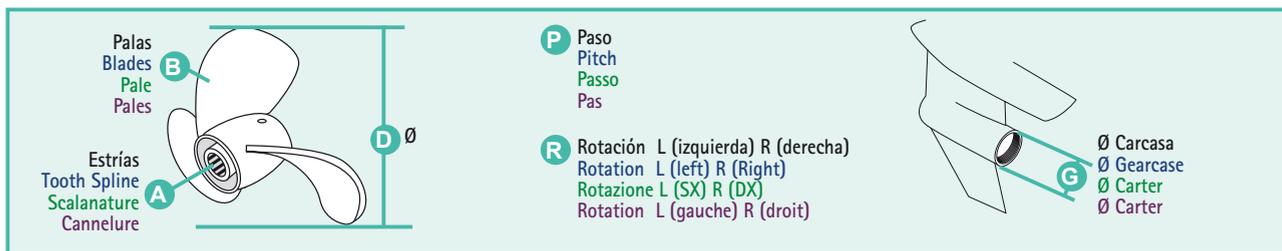

	2T STROKES	4T STROKES	R.O. OEM	A	G	B	D	P	R	AL	INOX STAINLESS STEEL	
			6G5-45941-00-98				15	15	R	SOL3511-150-15 SOL3513-148-15		
			6G5-45952-00-98				15	15	L	SOL3512-150-15 SOL3514-148-15	AMITA 3 AMITA 4	
			6G5-45947-01-98				14,8	17	R	SOL3511-148-17 SOL3513-145-17	AMITA 3 AMITA 4	
			6K1-45947-00-98				14,8	17	L	SOL3512-148-17 SOL3514-145-17	AMITA 3 AMITA 4	
			6G5-45945-01-98				14,5	19	R	SOL3511-145-19 SOL3513-143-19	AMITA 3 AMITA 4	
			6K1-45945-01-98				14,5	19	L	SOL3512-145-19 SOL3514-143-19	AMITA 3 AMITA 4	
			6G5-45949-00-98				14,3	21	R	SOL3511-143-21 SOL3513-140-21	AMITA 3 AMITA 4	
150 (1986+)							14,3	21	L	SOL3512-143-21 SOL3514-140-21	AMITA 3 AMITA 4	
175 (1984+)												
200 (1984+)												
200VMAX (2001+)			6G5-45949-00-98				14,2	23	R	SOL3511-142-23	AMITA 3	
220 (1987-88)							14,2	23	L	SOL3512-142-23	AMITA 3	
225 (1986+)												
250 (1990+)			6G5-45941-00-98				15 <sup>3/4</sup>	15	R			SOL3571-158-15 LEXOR
225VMAX (2001+)			6G5-45952-00-98				15 <sup>3/4</sup>	15	L			SOL3572-158-15 LEXOR
300 (2004+)			6G5-45947-01-98				15 <sup>1/2</sup>	17	R			SOL3571-155-17 LEXOR
F150 (2004+)			6K1-45947-00-98				15 <sup>1/2</sup>	17	L			SOL3572-155-17 LEXOR
F200 (2002+)			6G5-45945-01-98			3	15 <sup>1/4</sup>	19	R			SOL3571-153-19 LEXOR
F225 (2002+)			6K1-45945-01-98				15 <sup>1/4</sup>	19	L			SOL3572-153-19 LEXOR
F250 (2005+)			6G5-45949-00-98				15	21	R			SOL3571-150-21 LEXOR
F300 (2003+)							15	21	R			SOL3572-150-21 LEXOR
dentro-fueraborda			6G5-45949-00-98				14	23	R			SOL3571-148-23 LEXOR
Intro-outboard							14	23	L			SOL3572-148-23 LEXOR
Intro-Fuoribordo							14	25	R			SOL3571-145-25 LEXOR
Intro-horsbord							14	25	R			SOL3571-145-27 LEXOR
3.0L-7.4L			6G5-45970-02-98				15 <sup>1/4</sup>	15	R			SOL3531-145-15 NEW SATURN
			6K1-45970-01-98				15 <sup>1/4</sup>	15	L			SOL3532-145-15 NEW SATURN
			6G5-45978-03-98				13 <sup>3/4</sup>	17	R			SOL3531-143-17 NEW SATURN
			6K1-45978-02-98				13 <sup>3/4</sup>	17	L			SOL3532-143-17 NEW SATURN
			6G5-45974-03-98				13 <sup>3/4</sup>	19	R			SOL3531-140-19 NEW SATURN
			6K1-45974-02-98				13 <sup>3/4</sup>	19	L			SOL3532-140-19 NEW SATURN
			6G5-45972-02-98				13 <sup>3/4</sup>	21	R			SOL3531-140-21 NEW SATURN
			6K1-45972-01-98				13 <sup>3/4</sup>	21	L			SOL3532-140-21 NEW SATURN
			6G5-45976-01-98				13 <sup>3/8</sup>	23	R			SOL3531-140-23 NEW SATURN
			6K1-45976-00-98				13 <sup>3/8</sup>	23	L			SOL3532-140-23 NEW SATURN

HÉLICES PARA NÚCLEO INTERCAMBIABLE

PROPELLERS FOR INTERCHANGEABLE HUB

ELICHE PER MOZZO INTERCAMBIABILE

HELICES AVEC MOYEU INTERCHANGEABLE

	B	D	P	R	AL
<b>C</b> 30-75 HP	3	12.1	9	R	SOL9311-121-09
		12	10	R	SOL9311-120-10
		11-6	11	R	SOL9311-116-11
		11.4	12	R	SOL9311-114-12
		11.1	13	R	SOL9311-111-13
		11.1	14	R	SOL9311-111-14
<b>D</b> 40-140 HP	3	11	15	R	SOL9311-110-15
		14	9	R	SOL9411-140-09
		14	11	R	SOL9411-140-11
		13.75	13	R	SOL9411-138-13
		13.50	15	R	SOL9411-135-15
		13.25	17	R	SOL9411-133-17
<b>E</b> 135-350 HP	3	13.2	19	R	SOL9411-132-19
		13.2	21	R	SOL9411-132-21
		15.5	11	R	SOL9511-155-11
		15.3	13	R	SOL9511-153-13
		16	13	R	SOL9511-160-13
		15	15	R	SOL9511-150-15
		15	15	L	SOL9511-150-15
		14.8	17	R	SOL9511-148-17
		14.8	17	L	SOL9511-148-17
		14.5	19	R	SOL9511-145-19
14.5	19	L	SOL9511-145-19		
14.3	21	R	SOL9511-143-21		
14.3	21	L	SOL9511-143-21		

	B	D	P	R	INOX STAINLESS STEEL
<b>C</b> 30-75 HP	3	11 <sup>5/8</sup>	11	R	SOL9331-116-11
		11 <sup>3/8</sup>	12	R	SOL9331-114-12
		11 <sup>1/8</sup>	13	R	SOL9331-111-13
		11 <sup>1/8</sup>	14	R	SOL9331-111-14
		11	15	R	SOL9331-110-15
		<b>D</b> 40-140 HP	3	13 <sup>3/4</sup>	13
13 <sup>3/4</sup>	13			L	SOL9432-138-13
13 <sup>1/2</sup>	15			R	SOL9431-135-15
13 <sup>1/2</sup>	15			L	SOL9432-135-15
13 <sup>1/4</sup>	17			R	SOL9431-133-17
13 <sup>1/4</sup>	17			L	SOL9432-133-17
<b>E</b> 90-140 HP	3	13	19	R	SOL9431-130-19
		13	19	L	SOL9432-130-19
		13	21	R	SOL9431-130-21
		14 <sup>1/2</sup>	15	R	SOL9531-145-15
		14 <sup>1/2</sup>	15	L	SOL9532-145-15
		14 <sup>1/4</sup>	17	R	SOL9531-143-17
		14 <sup>1/4</sup>	17	L	SOL9532-143-17
		14	19	R	SOL9531-140-19
		14	19	L	SOL9532-140-19
		14	21	R	SOL9531-140-21
<b>E</b> 135-350 HP	3	14	21	L	SOL9532-140-21
		14	23	R	SOL9531-140-23
		14	23	L	SOL9532-140-23
		15 <sup>3/4</sup>	15	R	SOL9571-158-15
		15 <sup>3/4</sup>	15	L	SOL9572-158-15
		15 <sup>1/2</sup>	17	R	SOL9571-155-17
		15 <sup>1/2</sup>	17	L	SOL9572-155-17
		15 <sup>1/4</sup>	19	R	SOL9571-153-19
		15 <sup>1/4</sup>	19	L	SOL9572-153-19
		15	21	R	SOL9571-150-21
15	21	L	SOL9572-150-21		
14 <sup>3/4</sup>	23	R	SOL9571-148-23		
14 <sup>3/4</sup>	23	L	SOL9572-148-23		
14 <sup>1/2</sup>	25	R	SOL9571-145-25		
14 <sup>1/2</sup>	25	L	SOL9572-145-25		

**RUBEX**



Núcleo intercambiable (no incluido).  
Interchangeable hub (not included).  
Mozzo intercambiable (non incluso).  
Moyaux interchangeable (non inclus)

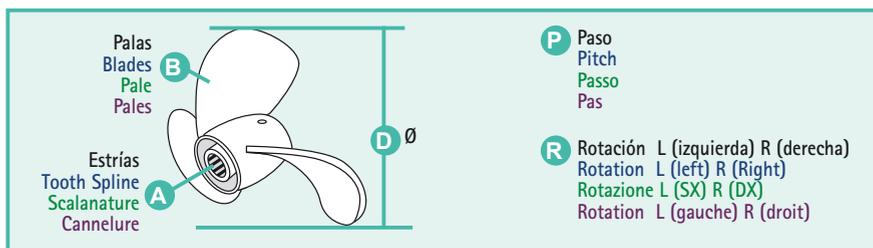

NÚCLEO INTERCAMBIABLE INTERCHANGEABLE HUB

MOZZO INTERCAMBIABILE

MOYEU INTERCHANGEABLE

	  		REF	
	2T STROKES	4T STROKES		
F30 (2001-05) F40 (1999+); F50 (1995+) F60 (1999+)	✓		13 SOLRBX-117	C
40HP et 50HP (not T50), (1984+) 48HP (1995+) 55HP (1976-95) 60HP (1976-91)			13 SOLRBX-117	C
T50 (1996+)			15 SOLRBX-108	D
60-100 HP (1984+)	✓	✓	15 SOLRBX-108	D
80-140HP, (1978-83)			15 SOLRBX-102	D
115HP FS115		✓	15 SOLRBX-103	D
130HP, (1984+)			15 SOLRBX-103	D
150-175HP, (1978-83)			15 SOLRBX-102	E
150-300HP, (1984+)			15 SOLRBX-103	E
225 EFI		✓	15 SOLRBX-103	E
F300, F350			17 SOLRBX-127	E+
300, 350HP, V8		✓	17 SOLRBX-127	E+
Stern drives, (1989-93)			15 SOLRBX-103	E



**RUBEX**

GUÍA DE RECAMBIOS DE HELICE

PROPELLER SPARE PARTS

GUIDA RICAMBIO ELICHE

GUIDE DES PIECES POUR HELICE

	1	2	3	4	5
F2.5A, F4B, F5A, F6C	PAF4-03000025		PAF4-03000026	PAF4-03080000	PAGB/T91-1.6X12
F8C, F8F			REC90201-10M01	REC90171-10M01	REC91490-30025
F9.9J			REC90201-10M01	REC90171-10M01	REC91490-30025
F15C, F20B	REC6E7-45987-00		REC90201-10M01	REC90171-10M01	REC91490-30025
F25D	REC6L2-45987-00	REC689-45997-00	PAGB/T97.1-14	REC90171-14013-00	REC91490-30030
FT25F	REC663-45987-00		REC92990-16200	REC90171-16011	REC91490-30030
F30, F40F, F50H, F60F	REC663-45987-00	REC66T-45997-00	REC90389-22M01	REC90171-16011	REC91490-30030
FT50J, FT60G	REC688-45987-00	REC67F-45997-00	REC90389-25M00	REC90171-16011	REC91490-30030
F70A, F80B, F100D	REC688-45987-00	REC67F-45997-00	REC90389-25M00	REC90171-16011	REC91490-30030
F(L) 115A, F(L) 115B, F130A, F(L)150A, F(L)150D, F175A, F(L)200F	REC6E5-45987-00	REC688-45997-00	REC92990-18200	REC90171-18M04	REC91490-40030
F(L)225F, F(L)250D, F(L)300B (4.2L) V6		REC688-45997-00	REC92990-18200	REC90171-18M04	REC91490-40030

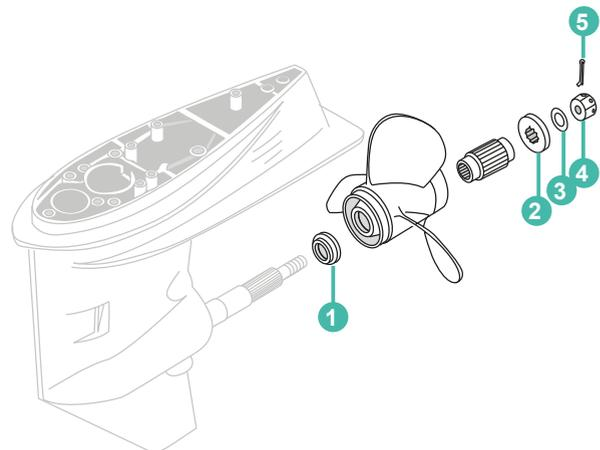

YAMAHA

RECAMBIOS MARINOS

# REF --> RO / OEM

REF	R.O. / OEM	
<b>C</b>		
CEF500302	6G1-44352-00	143
CEF500316	6H3-44352-00	143
CEF500320	682-44352-03	143
CEF500321	662-44352-01	143
CEF500322	6L5-44352-00	143
CEF500323	688-44352-03	143
CEF500324	646-44352-01	143
CEF500325	6E0-44352-00	143
CEF500326	689-44352-02	143
CEF500352	6F5-44352-00	143
CEF500363	63V-44352-01	143
CEF500364	67F-44352-00	143
CEF500368	68T-44352-00	143
CEF500371	6E5-44352-01	143
CEF500384	6L2-44352-00	143
CEF500385G	6H4-44352-02	143
CEF500389N	6AW-44352-00	143-155
CEF500401N	6CE-44352-00	143
CHAL77JC4		108
CHAL82C		108
CHAL90C		108
CHAQL77JC4		108
CHAQL78C		108
CHAQL82C		108
CHAQL86C		108
CHARA8HC		108
CHARC12YC		108
CHARC9YC4		108
CHAZ9Y		108
CM15008	66M-11325-00	159
CM15008A	66M-11325-00	159
CM15026	6E5-11325-00	158-169
		65-70-72-73-158-169-187-209-213
CM15026A	6E5-11325-00	158
CM3082523	689-11325-00	158
CM41106-ZW000	41106-ZW-000	158
CM42121		159
CM43107M	677-45251-00	169
CM61A-11325-00	61A-11325-00	161
CM61A-45371	61A-45371-00	160-169-383
CM61A-45371-00A	61A-45371-00	160-169-331-335-337
CM61N-45251-01	61N-45251-01	160-169-291-351-355
CM61N-45251-01A	61N-45251-01	65-66-160-169
CM62Y-11325-00	62Y-11325-00	158
		65-66-67-68-69-158-197-203-205-207
CM62Y-11325-00A	62Y-11325-00	159-169
CM63D-45251-01	63D-45251-01	169
CM63D-45251-01A		169
CM63P-11325-01	63P-11325-00	161
CM63P-11325-01	63P-11325-01	161
CM63P-11325-01		169
CM63P-11325-01A	63P-11325-00	161
CM63P-11325-01A	63P-11325-01	161-211-214
CM63P-11325-01A		70-71-73
CM63P-11325-11	63P-11325-11	161-169
CM63P-11325-11A	63P-11325-11	71-73-161-211
		169-357-359-361
CM664-45371-01	664-45371-01	361
CM664-45371-01	664-45371-01-00	353
CM664-45371-01	664-45371-01A	160
CM664-45371-01A	664-45371-01A	66-160-169
CM66M-11325-00A		65
CM66M-45371-00	66M-45371-00	159-169-291
CM679-45251-00	679-45251-00	160
CM679-45251-00A	679-45251-00	160
CM67C-45251-00	67C-45251-00	158-169-361
		66-67-69-158-299-303-307-311
CM67C-45251-00A	67C-45251-00	160-169
CM67C-45371-00	67C-45371-00	160-169
		66-67-68-69-160-169-299-303-307-311
CM67C-45371-00A	67C-45371-00	159
CM67F-11325-00	67F-11325-00	161
CM67F-11325-01	67F-11325-01	161
CM67F-11325-01A	67F-11325-01	70-71-72-73-161-211-213
CM67F-45371-00	67F-45371-00	70-161
CM67F-45371-00A	67F-45371-00	68-69-161-315-319
CM688-45251-01	688-45251-01	158-169
CM688-45251-01A	688-45251-01	67-68-69-158-169
CM688-45371-02	688-45371-02	371
CM688-45371-02	688-45371-02	160-169
CM688-45371-02	688-45371-02-00	373
CM688-45371-02A		160-169
CM689-11325-00A	689-11325-00	158
CM68T-11325-00	68T-11325-00	161
CM68T-11325-00A	68T-11325-00	71-72-73-161-211
CM68T-45251-00	68T-45251-00	158-169
CM68T-45251-00A	68T-45251-00	64-65-158-169-289
CM68V-11325-01	68V-11325-01	158
CM68V-11325-01A	68V-11325-01	158
CM68V-11325-01A	68V-11325-02	209
CM68V-11325-01A		69
CM69L-45371-00	69L-45371-00	160-169
CM69L-45371-00A	69L-45371-00	160-169
CM6AW-45251-00	6AW-45251-00	161-169

REF	R.O. / OEM	
CM6AW-45251-00A	6AW-45251-00	72-161-169
CM6AW-45373-00	6AW-45373-00	161-169
CM6AW-45373-00A	6AW-45373-00	161-169-341
CM6AW-45619-00	6AW-45619-00	161
CM6AW-45619-00A	6AW-45619-00	161-341
CM6BL-11325-00	6BL-11325-00	161
CM6BL-11325-00A	6BL-11325-00	66-161-195
CM6E0-45251-11	6E0-45251-11	347
CM6E0-45251-11	6E0-45251-11-00	158
CM6E0-45251-11	6E0-45251-11	169
CM6E0-45251-11A	6E0-45251-11-00	65-66-67-68-69-158-169
CM6E5-45251-00	6E5-45251-00	158-169
CM6E5-45251-00A		66-158-169
CM6E5-45371-01A	6E5-45371-00	323
CM6E5-45371-01A	6E5-45371-01	161-379
CM6E5-45371-01A		70-71-169
CM6E5-45371-10	6E5-45371-10	160
CM6E8-45251-00	6E8-45251-00	159
CM6E8-45251-01	6E8-45251-02	159-169
CM6G1-45251-02	6G1-45251-02	159-169
CM6G1-45251-03	6G1-45251-03	159
CM6G1-45251-03	6GH-45251-00	159
CM6G1-45251-03	6N0-WG525-00	159
CM6G1-45251-03	6G1-45251-03	169
CM6G5-45251-01	6G5-45251-01	158-169
CM6G5-45251-01A	6G5-45251-01	70-158-169
CM6G8-11325-00	6G8-11325-00	159-169-181
		65-159-180-187-195-201-203-205
CM6G8-11325-00A	6G8-11325-00	159-169
CM6G8-45251-01	6G8-45251-00	158-169
CM6H1-45251-01	6H1-45251-01	158-169
CM6H1-45251-01A	6H1-45251-01	158
CM6H1-45251-02	6H14525102	158-169
CM6H1-45251-02A	6H14525102	69-70-71-158-169
CM6H3-11325-01A	6H3-11325-01	241
CM6J9-45371-01	6J9-45371-01	160-169
CM6J9-45371-01A	6J9-45371-01	72-160-169-327
CM6K1-45371-00	6K1-45371-00	161-169
CM6K1-45371-00A	6K1-45371-00	161-169
CM6K1-45371-02	6J9-45371-02	160-169
CM6K1-45371-02A	6J9-45371-02	72-160-169
CM6L5-45251-02	6L5-45251-02	159-169-343
CM6L5-45251-02	6L5-45251-03	345
CM6L5-45251-02A	68D-G5251-00	287
CM6L5-45251-02A	6L5-45251-02	159
CM6L5-45251-02A		64-169
CM6T4-45836-00	6T4-45836-00	159
CM6T5-45371-00	6T5-45371-00	161
CM6T5-45373-00	6T545373-00	159
CM6U0-45251-00	6U0-45251-00	159-169
CM6U4-45251-00	6U4-45251-00	158-169
CM825171		158
CM82795M		160
CM82795MA		160
CM85007	688-11325-00	160
CM85007A	688-11325-00	160
CMY150CRKITA		71-162
CMY150CRKITEM		162
CMY150KITA		71-162
CMY150KITM		162
CMY200250KITA		72-73-162
CMY200250KITM		162
CMY200300KITA		162
CMY300350KITA		73-162
CMY300350KITM		162
CMY300350XPKITA		73-162
CMY300350XPKITM		162
CMY4050KITA		162
CMY4050KITM		162
CMY4060KITA		162
CMY4060KITM		162
CMY6090KITA		162
CMY6090KITM		162
CMY80100KITA		162
CMY80100KITM		162
CMYHP200300KITA		162
<b>G</b>		
GS11290		121
GS11291		121
GS11292		121
GS11294		121
GS30435		80
GS31001		80
GS31002		80
GS31020		77
GS31064		77
GS31065	YMM-2FE10-00	79
GS31066	YMM-2FS08-00	79
GS31067	YMM-2FS10-00	79
GS31068		76
GS31069		76
GS31073		77
GS31074	6Y1-24305-05-00	76
GS31074	6Y1-24305-06	76
GS31074	6Y1-24305-06-00	76
GS31074	6YL-24305-01-00	76
GS31075	6G1-24305-00	76
GS31075	6G1-24305-01	76
GS31075	6G1-24305-02	76

REF	R.O. / OEM	
GS31075	6G1-24305-02-00	76
GS31075	6G1-24305-03	76
GS31075	6G1-24305-03-00	76
GS31075	6G1-24305-04	76
GS31075	6G1-24305-04-00	76
GS31075	6G1-24305-05	76
GS31075	6G1-24305-05-00	76
GS31075	6G1-24305-0500	76
GS31075	6Y1-24305-00	76
GS31075	6Y1-24305-01	76
GS31075	6Y1-24305-02	76
GS31075	6Y1-24305-05-00	76
GS31075	6Y1-24305-06-00	76
GS31075	6YL-24305-01-00	76
GS31076	6E5-24305-05-00	76
GS31076	6E5-24305-06	76
GS31076	6E5-24305-06-00	76
GS31076	6Y2-24305-05-00	76
GS31076	6Y2-24305-06-00	76
GS31076	6YK-24305-01-00	76
GS31090	6Y2-24360-52	74
GS31092		77
GS31095		74
GS31096		74
GS31097		74
GS31099		74
GS31155		79
GS31156		79
GS31157		79
GS31166	YMM-2FE08-00	79
GS31183	6Y1-24360-52-00	74
GS31183	6Y1-24360-52-01	74
GS31183	6Y1-24360-52-02	74
GS31183	6Y1-24360-52-51	74
GS31183	6Y1-24360-52-52	74
GS31187	6Y1-24360-52	74
GS31031	90890-56878	75
GS35032	90790-77001	75
GS40015	YMD-RCBOX-00-10	127
GS41084	6E5-61301-00	130
GS41084	6E5-61301-01	130
<b>N</b>		
NGKB7HS	94702-00040	220-235-239
NGKB7HS-10	94702-00217	225-229
NGKB7HS-10	94702-00271	227
NGKB8HS	94702-00041	239
NGKB8HS-10	90472-00247	243
NGKB8HS-10	94702-00160	239
NGKBKR6EUKU	94702-00405-00	108
NGKBKR7EUKU	94702-00404-00	108
NGKBPR7HS	94702-00248	175
NGKBR5HS	94702-00249-00	108
NGKBR6FS	94701-00365-00	108
NGKBR6HS	94701-00248-00	108
NGKBR6HS	94702-00248	64-173
NGKBR6HS-10	94702-00274	64-65-180-223
NGKBR6HS-10	94702-00274-00	108
NGKBR7HS	94701-00110	108
NGKBR7HS	94701-00110-10	108
NGKBR7HS	94702-00272	221-233
NGKBR7HS-10	94702-00271	223-229-231-237
NGKBR7HS-10	94702-00271-00	108
NGKBR8ES	94701-00204	108
NGKBR8ES-11	94702-00396	108
NGKBR8HS	94701-00195	108
NGKBR8HS	94701-00195-00	108
NGKBR8HS-10	94702-00247	237-241-245
NGKBR8HS-10	94702-00247-00	108
NGKBR8HS-10	94702-00271	247
NGKBR9HS-10	94701-00309-00	108
NGKBR9HS-10	94702-00309	245
NGKCR5HSB	94701-00300-00	108
NGKCR6HS	94701-00282	181
NGKCR6HS	94701-00282-00	108
NGKCR6HS	94702-00372-00	108
NGKCR6HSB	94702-00372	64-173-179
NGKCR9EB	94702-00409	108
NGKDPRE5EA-9	94701-00406-00	69-108
NGKDPRE6EA-9	94701-00375	65-66-67-68-197-207
NGKDPRE6EA-9	94701-00375-00	108
NGKDPRE6EB-9	94702-00418	65-66-67-68-69-187-195-201-203
NGKDPRE6EB-9	94702-00418-00	108
NGKDPRE7EA-9	94701-00375	185-191
NGKLF5A-11	94702-00391	69-70-71-72-209-211
NGKLF5A-11	94702-00391-00	108
NGKLF6A-11	94702-00400	70-72-73-213-214
NGKLF6A-11	94702-00400-00	108
NGKLF6A-11	94	



REF	R.O. / OEM	
PA166F-010008	67D-12157-00	173-175-179
PA166F-010009	67D-12151-00	173-175-179
PA166F-010010	7FK-12165-00	173-175-179
PA166F-010011	7FK-12158-00	173-175-179
PAE4-10040100W	703-82563-00	122-128
PAE4-10040100W	703-82563-01	122-128
PAE4-10040100W	703-82563-02	128
PAF15-00000001	63V-45551-00-4D	132
PAF15-00000001	66M-44551-00-4D	132
PAF15-00000002	682-44555-30	135
PAF15-00000003	66M-44557-00	135
PAF15-00000005	66M-45113-00	271
PAF15-00000013	93604-10M03	201-317-351 171-173-283- 289-291-293- 351
PAF15-00000013	93604-12M07	183-217-218- 351
PAF15-00000014	66M-11351-10	233
PAF15-01000001	65F-42537-00	133
PAF15-01000004	90386-30048	133
PAF15-01000006	90386-30M60	133
PAF15-01010001	63V-43131-00	131
PAF15-01010001	63V-43131-01	131
PAF15-01010001	63V-43131-10	131
PAF15-01010007	63V-43145-00	131
PAF15-01010007	90185-22043	131
PAF15-01010007	90185-22M11	131
PAF15-01010100	63V-43111-00-4D	131
PAF15-01010100	63V-43111-01-4D	131
PAF15-01010100	63V-43111-A2-4D	131
PAF15-01010200	63V-43112-00-4D	131
PAF15-01010200	63V-43112-01-4D	131
PAF15-01010200	63V-W4311-00-4D	131
PAF15-01010200	63V-W4311-03-4D	131
PAF15-01010200	63V-WS431-B6-8D	131
PAF15-01010301S	63V-43311-00-4D	131
PAF15-01010301S	63V-43311-01-4D	131
PAF15-01010301S	99999-03116	131
PAF15-01010302	90386-22M15	133
PAF15-01030100	65W-42138-00	131
PAF15-02000005L	66M-44361-10	291
PAF15-02000005S	66M-44361-00	291
PAF15-02000006	63V-44365-10	289-291-351
PAF15-02010000	66M-44514-00-4D	135
PAF15-03000003	66M-45115-00	268
PAF15-04000002	90340-14M00	237-241 191-195-197- 201-203-205- 207-209-211- 213
PAF15-04000002	90340-14M06	195-197-201- 207-209-211- 213-235-237- 239-241
PAF15-04000003	90430-14115	65-66-67-68- 69-70-71-72- 73-191
PAF15-04000003	90430-14M09	173-179-181- 183-195-213- 225-227-229- 231-233
PAF15-04000005	676-11372-00	187
PAF15-04000005	6H1-11372-00	187
PAF15-04010004	66M-41138-00	268
PAF15-05000009	6BL-44391-00	139
PAF15-05000009	6H3-44391-00	139
PAF15-05000009	6H3-44391-01	139
PAF15-05000011	688-24378-00	183-191-195- 197-207
PAF15-05000012	90445-09061	183
PAF15-05000013	90445-09086	183
PAF15-05000014	90445-09104	183-197-207
PAF15-05170300W	6G1-81941-10	111-114
PAF15-06000001	63V-45311-01-4D	351
PAF15-06000002	63V-45215-00	293-350
PAF15-06000002	6G1-45215-00	289
PAF15-06000003	6G1-45214-00	289-293-350
PAF15-06000004	61N-45251-00	295
PAF15-06000006	63V-45536-00	291-292-351
PAF15-06000008	6E8-45587-10	293
PAF15-06000008	6E8-45587-10-13	291-351
PAF15-06000009	6E7-45587-01-30	348
PAF15-06000009	6E8-45587-30	293
PAF15-06000010-1	664-45567-01-10	291-351
PAF15-06000010-1	664-45567-05	349
PAF15-06000010-1	664-45567-01	293
PAF15-06000010-2	664-45567-10	293
PAF15-06000010-2	664-45567-12	349
PAF15-06000010-3	664-45567-20	293
PAF15-06000010-4	664-45567-30	293
PAF15-06000010-5	664-45567-40	349
PAF15-06000010-6	664-45567-50	293
PAF15-06000010-7	664-45567-60	349
PAF15-06000010-7	664-45567-60	293
PAF15-06000014	63V-44328-00	289-291-351
PAF15-06000014	63V-44328-01	293
PAF15-06000015	6E7-45987-01	351
PAF15-06000016	90171-10M01	349
PAF15-06000020-1	90201-15017	293
PAF15-06020005	63V-45375-00	289-291-292- 351
PAF15-06030000L	63V-44150-10	291-351
PAF15-06030000S	63V-44150-00	291-351
PAF15-06040000S	63V-45510-00	291
PAF15-06070002	90501-14M06	291-349-351
PAF15-06070002	90501-150A0	293
PAF15-06080000	683-45361-02-8D	293

REF	R.O. / OEM	
PAF15-06080003	93210-56M80	231-291-293- 351
PAF15-06080006-1	626-45577-00	293-351
PAF15-06080006-1	626-45577-00-01	291-349
PAF15-06080006-2	626-45577-10	293
PAF15-06080006-3	626-45577-00-03	349
PAF15-06080006-3	626-45577-20	293
PAF15-06080006-4	626-45577-30	293
PAF15-06080006-5	626-45577-00-05	349
PAF15-06090000	63V-45943-10-00	402
PAF15-06100000L	66M-45300-11-4D	277-291
PAF15-06100000S	66M-45300-02-4D	277-291
PAF15-07000000	66M-W009B-15-1S	185
PAF15-07000001	99510-10114	180-183-185
PAF15-07000001	91810-03014	181
PAF15-07000013	93604-12M07	183
PAF15-07000016	661-41262-01	100
PAF15-07000016	661-41262-02	100
PAF15-07000024	66M-46297-00	185
PAF15-07000028	90105-08M78	180-185
PAF15-07000030	97013-06035	197
PAF15-07000031	66M-12411-00	137
PAF15-07000031	66M-12411-01	137-179-180- 183
PAF15-07000031	6G8-12411-02	191
PAF15-07000031	6G8-12411-03	66-67-68-69- 137-195-197- 201-203-205- 207
PAF15-07000100	66M-11181-10	185-215-218
PAF15-07000200	66M-85580-00	107
PAF15-07000300	66M-85520-00	106
PAF15-07000400	66M-85533-00	104
PAF15-07000500	66M-85540-10	118
PAF15-07000600	66M-85570-00	104
PAF15-07010000	66M-15100-02-1S	183
PAF15-07010003	6C5-12858-00	187
PAF15-07010003	90401-20M00	183-191-197
PAF15-07010004	90344-51003	203-205
PAF15-07010006	6E5-24377-00	181-183
PAF15-07010007	90445-10M46	183
PAF15-07010008	66M-11325-00	183
PAF15-07010009	66M-11328-00	65-66-67-68-69- 183-191-197- 203-205-207
PAF15-07010011	66M-11327-00-94	168-183-191- 197-203-205- 207
PAF15-07010012	66M-12535-00	183-191-197- 203-205-207
PAF15-07010014	66M-11357-00	183
PAF15-07010015	90465-08M83	195
PAF15-07010018	66M-41114-01	65-140-183
PAF15-07010019	66M-41113-20-1S	183
PAF15-07010021	6H3-12413-00-1S	197-207-241
PAF15-07010021	6H3-12413-00-9M	191
PAF15-07010021	6H3-12413-001S	183
PAF15-07010022	62Y-12414-00	66-67-68-69- 138-183-191- 195-197-201
PAF15-07010023	5GH-13440-00	183
PAF15-07010024	66M-11416-00	183
PAF15-07010026	6E5-11325-00	183
PAF15-07010027	90480-12072	185-209-211
PAF15-07010103	62Y-82504-10	103
PAF15-07010103	65W-82504-00	103
PAF15-07010200	66M-11168-001S	183
PAF15-07020001	66M-11631-00-96	183-219
PAF15-07020005	93450-15023	183-219
PAF15-07020006	634-11633-00	183-219
PAF15-07020100	66M-11650-00	183
PAF15-07030000	66M-11411-00	183-219
PAF15-07030003	66M-11536-10	185
PAF15-07030004	66M-11557-00	185
PAF15-07030005	90170-28M37	185
PAF15-07030006	93102-25014	189
PAF15-07030006	93102-35M51	183
PAF15-07030007	93102-25M52	183
PAF15-07040000	66M-11111-01-1S	185
PAF15-07040001	66M-12111-00	185
PAF15-07040002	66M-12121-00	185
PAF15-07040004	66M-12116-00	185
PAF15-07040005	66M-12113-00	185
PAF15-07040006	30X-12117-00	189-193-195- 199-201-203- 207
PAF15-07040007	30X-12118-00	185-189-193- 195-199-201- 203-207
PAF15-07040008	93102-18M21	180-185
PAF15-07040009	90387-13001	185
PAF15-07040011	90387-13002	185
PAF15-07040012	90387-13M56	180-185
PAF15-07040013	90501-12M41	185
PAF15-07040014	90501-12M40	180-185
PAF15-07040015	66M-12146-00	185-189
PAF15-07040016	66M-13329-10	185
PAF15-07040017	90201-13201	180-185
PAF15-07040018	66M-11537-00-94	185
PAF15-07040020	66M-12170-00	185
PAF15-07040301	66M-12151-10	185
PAF15-07040300	62Y-12159-00	185-193-199
PAF15-07040303	64J-12159-00	189
PAF15-07040304	62Y-12158-00	185-189-193- 195-199-201- 203-205-207

REF	R.O. / OEM	
PAF15-07040500	66M-13300-10	185
PAF15-07050001	66M-11191-00-1S	185
PAF15-07050002	66M-11356-00	185
PAF15-07050003	90480-10M16	185
PAF15-07050004	69M-E5363-00	171-180 181-185-187- 191-195-197- 201-203-205- 207-209-211- 213-214
PAF15-07050004	6G8-15363-00	
PAF15-07050006	30X-12117-00	185
PAF15-07060001	6J8-81960-00	117
PAF15-07070000	66M-85550-00	109
PAF15-07070100W	66M-85550-10	109
PAF15-07080000	61N-24560-00	80
PAF15-07080002	61N-24521-00	80
PAF15-07090000	66M-14301-00	91
PAF15-07090000W	66M-14301-00	91
PAF15-07130001	63V-15716-00	113
PAF15-07130107	63V-15713-00	112
PAF15-07130201	63V-15714-00	113
PAF15-07130202	63V-15741-00	112
PAF15-07130203	63V-15767-00	112
PAF15-07130204	63V-15784-00	112
PAF15-07140000	66M-24410-11	85
PAF15-09000000	6G1-24306-55	74
PAF15-09000000	6Y1-24306-55-00	74
PAF15-10000002	6YJ-24167-00	76
PAF15-10000003	6Y1-24268-00	76
PAF15-10010000	6YJ-24610-00	75
PAF15-10010000	6YJ-24610-01	75
PAF15-10020000	6YJ-24260-00	76
PAF15-10020000	6YJ-24260-10	76
PAF15-10030001	66M-12138-60	185
PAF15-11000002W	703-48293-10	129
PAF15-11020000W	63V-61350-00	130
PAF15-13000000W	6YJ-24260-10	126
PAF15-13000100W	688-82586-21	128
PAF15-13000200W	703-82510-12	113
PAF15-13000500W	703-48261-01	127
PAF15-13010010W	703-48245-00	130
PAF15-13020007W	703-48152-00	129
PAF166-010003	51Y-12119-00	179-193
PAF2.6-00000003	69M-45113-A0	173-217-218
PAF2.6-00000004	69M-24575-00	76
PAF2.6-02000003L	69M-44361-10	283
PAF2.6-02000003S	69M-44361-00	283
PAF2.6-03000001	69M-G5311-00-4D	283
PAF2.6-03000002	6L5-45317-09	283
PAF2.6-03000003	6L5-45316-09	283
PAF2.6-03000004	93103-09M41	283
PAF2.6-03000007	69M-G5315-A0	283
PAF2.6-03000009	69M-G5321-00-94	283
PAF2.6-03000010	93210-05001	283
PAF2.6-03000010	69M-G4323-00	148-154-283
PAF2.6-03000011L	69M-G5511-10	283
PAF2.6-03000011S	69M-G5511-00	283
PAF2.6-03000012	93440-08819	28

REF	R.O. / OEM	
PAF2.6-04030000	69M-11400-00	173-219
PAF2.6-04040001	69M-E2155-00	173
PAF2.6-04040100	69M-E1111-00-1S	173
PAF2.6-04050001	69M-E5111-00-1S	171
PAF2.6-04050100	69M-E3102-00	171
PAF2.6-04060000	69M-E5396-00-5B	171
PAF2.6-04060001	69M-E5396-00	171
PAF2.6-04060002	93210-09004	171
PAF20-02000005	6AH-44368-00	293
PAF20-02000007	6AH-44365-00	293
PAF20-02000101L	6AH-44361-11	293
PAF20-02000101S	6AH-44361-01	293
PAF20-04000000L	6AH-45300-10-4D	277
PAF20-04000000L	6AH-45300-10-8D	277-292
PAF20-04000000S	6AH-45300-00-4D	277
PAF20-04000000S	6AH-45300-00-8D	277-292
PAF20-04000001	69G-45315-A0	292
PAF20-04010001	69G-45331-01-CA	292
PAF20-04020000L	6AH-44150-10	292
PAF20-04020000S	6AH-44150-00	292
PAF20-04030000L	6AH-45510-10	293
PAF20-04030000S	6AH-45510-00	293
PAF20-04040001	6AH-44311-00	147-293
PAF20-05000000	6AH-W009B-02-1S	189
PAF20-05000002	90105-090006	187
PAF20-05000003	6AH-46241-00	189-267
PAF20-05000016	6AH-12481-00	187
PAF20-05000027	6AH-11536-00	189
PAF20-05000028	6AH-11557-00	189
PAF20-05000029	90170-30003	189
PAF20-05000034	90480-10627	189
PAF20-05000036	90480-06M19	189
PAF20-05000100	6AH-85580-00	107
PAF20-05000200	6AH-85510-00	121
PAF20-05000300	6AH-85540-00	118
PAF20-05000500	6AH-85550-00	109
PAF20-05000500W	6AH-85550-10	109
PAF20-05000600	6AH-41113-01-1S	187
PAF20-05000602	6AH-41114-00	187
PAF20-05000700	6AH-12413-00-1S	187
PAF20-05000702	6AH-12414-00	65-187
PAF20-05000900W	6AH-81800-00	111
PAF20-05000900W	6AH-81800-01	111
PAF20-05010000	6AH-15100-00	187
PAF20-05010003	6AH-11416-00	189
PAF20-05010007	97013-06040	187
PAF20-05020001	6AH-11631-00	189-219
PAF20-05020002	93450-17129	189-219
PAF20-05020003	137-11633-10	189-219
PAF20-05020004	6AH-11411-00	189-219
PAF20-05020100	6AH-11603-00	189-219
PAF20-05020200	6AH-11650-10	189
PAF20-05030001	6AH-12111-00	189
PAF20-05030002	6AH-12121-10	189
PAF20-05030003	62Y-12116-00	189
PAF20-05030004	3YF-12113-00	189
PAF20-05030005	93102-22010	189
PAF20-05030006	90387-13006	189
PAF20-05030007	90501-120A5	189
PAF20-05030008	6AH-12279-00	189
PAF20-05030009	6G8-11197-01	203-205
PAF20-05030010	6G8-11197-A0	187
PAF20-05030011	6AH-13329-10	189
PAF20-05030012	90201-15423	189
PAF20-05030013	6AH-11537-00	189
PAF20-05030100	90201-08784	189
PAF20-05030100	6AH-11111-10-1S	187
PAF20-05030200	6AH-12170-00	189
PAF20-05030301	6AH-12151-00	189
PAF20-05030400	6AH-13300-00	189
PAF20-05040000	6AH-11191-001S	187
PAF20-05040002	6AH-11356-00	187
PAF20-05040003	6AH-11168-00	187
PAF20-05040004	6AH-11169-00	187
PAF20-05040005	62Y-14485-00	195
PAF20-05040005	6AH-11372-00	187
PAF20-05050000	6AH-24410-00	85
PAF20-05000702	6AH-12414-00	138
PAF20-07000100W	63AH-61350-00	130
PAF25-00000011	90105-10M12	295
PAF25-00000013	65W-11351-00	191
PAF25-00000013	65W-11351-10	21821-7
PAF25-00000014	93608-12063	235-239-241-243
PAF25-00000014	99530-08012	191-197-201-203-205-207
PAF25-01000001	90386-52M02	133
PAF25-01000004	90386-44M03	133
PAF25-01010002	90386-22M15	133
PAF25-02000004L	65W-44361-10	297
PAF25-02000004S	65W-44361-00	297
PAF25-02000005	90430-12072	297
PAF25-02000019	90202-12060	297-301-305-309-367-371
PAF25-02010005	62Y-11325-00	191
PAF25-02010007	67C-15312-00	271
PAF25-03000007	90387-06M69	133
PAF25-03000008	90445-09068	191-197-207
PAF25-03000009	90445-09095	191-197-207
PAF25-03000009	90445-09104	195
PAF25-03000011	90445-09105	191
PAF25-03000011	90445-09251	195
PAF25-04000001	61N-45311-02-4D	295
PAF25-04000002	61N-45536-00	297-355
PAF25-04000003-2	61N-45587-00-10	297

REF	R.O. / OEM	
PAF25-04000003-3	61N-45587-00-11	297
PAF25-04000003-4	61N-45587-00-12	297
PAF25-04000003-5	61N-45587-00-13	297
PAF25-04000003-6	61N-45587-00-14	297
PAF25-04000003-7	61N-45587-00-15	297
PAF25-04000004-3	6L2-45567-12	295
PAF25-04000004-5	6L2-45567-14	295
PAF25-04000005	61N-45551-00	295
PAF25-04000007	93604-08062	214-223-239-301-305-309-313-349-357-363-367
PAF25-04000007	93604-10M03	195-203-205-297-321-355-371
PAF25-04000008	65W-45331-00-5B	297
PAF25-04000009	61N-45315-00	297-355
PAF25-04000012	65W-44176-00	297
PAF25-04000013	61N-45127-00	297-355
PAF25-04000015	90280-03024	155-297
PAF25-04000016	65W-44328-00	297
PAF25-04000017	61N-44362-10	297-355
PAF25-04000017S	61N-44362-00	297-355
PAF25-04000021	61N-45214-00	295
PAF25-04000022	6L2-45214-00	295
PAF25-04000023	6L2-45215-00	295
PAF25-04010000L	61N-45510-10	297
PAF25-04010000S	61N-45510-00	297
PAF25-04030000L	65W-44150-10	297
PAF25-04030000S	65W-44150-00	297
PAF25-04050000	61N-44311-01	297
PAF25-04050001	61N-44311-01	148-154-155-297-355
PAF25-04050003	93210-45161	66-154-155-297-355
PAF25-04050004	6L2-44367-00	293-297-355
PAF25-04060000	648-45633-11	295
PAF25-04060002	90501-10065	295-355-357
PAF25-04060003	664-45631-02	295
PAF25-04060007	90201-20417	295
PAF25-04070000	61N-45361-01-8D	295-388-389
PAF25-04070001	61N-45361-01-4D	295-355
PAF25-04070004	61N-45571-00	295
PAF25-04070005-1	6L2-45577-00-10	295-355
PAF25-04070005-3	6L2-45577-00-12	295
PAF25-04080000	664-45947-01-EL	295
PAF25-04090000L	65W-45300-01-4D	278
PAF25-04090000L	65W-45300-10-4D	295
PAF25-04090000S	65W-45300-00-4D	295
PAF25-04090000S	65W-45300-01-4D	278
PAF25-05000002	90119-09M00	191-197-207
PAF25-05000003	65W-11356-00	191
PAF25-05000004	65W-11191-00-94	191
PAF25-05000005	65W-15121-00	191
PAF25-05000007	65W-15121-00	191
PAF25-05000016	90464-07M05	241
PAF25-05000021	65W-11536-10	193-199
PAF25-05000022	65W-11476-00	193-199
PAF25-05000024	90280-04M06	199
PAF25-05000026	90170-20137	195
PAF25-05000026	90170-35M47	193
PAF25-05000100	5GH-13440-00	191
PAF25-05010000	65W-15100-00-94	191
PAF25-05010103	65W-11168-00	191
PAF25-05010106	65W-11119-00	197
PAF25-05010106	66W-11119-00	191
PAF25-05010107	65W-13286-00	191
PAF25-05010108	65W-11169-00	191
PAF25-05010111	65W-41114-00	141-191
PAF25-05010112	65W-41113-01-94	191
PAF25-05010113	62Y-11372-01	191
PAF25-05010113	62Y-12481-10	203-205
PAF25-05010201	65W-85790-00	103
PAF25-05010302-1	62Y-11416-00	193-199
PAF25-05010302-2	62Y-11416-10	193-199
PAF25-05020001	65W-11411-01	193-219
PAF25-05020002	93102-35M47	193-199
PAF25-05020003	93102-43M42	193-199-199-201-203-207
PAF25-05020100	65W-11631-00-96	193-199-219
PAF25-05020101	65W-11631-00-96	193-199
PAF25-05020105	62Y-11633-00	193-195-199-201-203-205-207-219
PAF25-05020106	93450-17129	193-195-199-201-203-205-207-219-231
PAF25-05020200	62Y-11650-10	199
PAF25-05020200	67C-11650-00	193
PAF25-05020200	6C5-11650-00	195-203-207
PAF25-05020200	6C5-11650-10	201-205
PAF25-05020203-1	62Y-11656-00	193-199
PAF25-05020203-2	62Y-11656-00	193
PAF25-05020203-2	62Y-11656-10	199
PAF25-05020204	62Y-11654-00	193-199
PAF25-05020204	6AH-11654-00	189
PAF25-05020204	6C5-11654-00	195-201-203-205-207
PAF25-05020301	65W-11642-11	193
PAF25-05020310	65W-11665-00	193
PAF25-05040000	65W-11181-30	191-215-218
PAF25-05050001	67C-12111-00	193-199
PAF25-05050002	62Y-12121-00	193-199-207
PAF25-05050003	62Y-12116-00	193-195-199-201-203-207

REF	R.O. / OEM	
PAF25-05050005	51Y-12114-00	193-195-199-201-203-207
PAF25-05050006	90109-06M65	191-195-197-201-203-205-207
PAF25-05050007	90430-06014	191-195-197-201-203-205-207
PAF25-05050008	65W-12146-00	193
PAF25-05050009	62Y-12238-00	193-207
PAF25-05050011	62Y-12216-00	193-199-207
PAF25-05050012	62Y-12231-00	193-207
PAF25-05050013	93210-12MG9	193-199-207
PAF25-05050014	93210-14515	193-199-207
PAF25-05050015	93210-33MH2	193-199-207
PAF25-05050016	93605-14143	193-199-207
PAF25-05050017	65W-11537-01	193
PAF25-05050018	90201-10144	201
PAF25-05050018	90201-10M06	193-199-207
PAF25-05050019	90109-08M63	193-199-207
PAF25-05050021	93102-37004	189
PAF25-05050021	93102-37M40	193-195-199-201-203-205-207
PAF25-05050100	65W-11111-02-94	191
PAF25-05050200	65W-12171-10	193
PAF25-05050300	65W-12151-00	193
PAF25-05050301	65W-12151-00	193-199
PAF25-05050400	65W-13300-00	193
PAF25-05070000	65W-14901-12	91
PAF25-05070019	6H4-14548-00	99
PAF25-05080004	65W-14457-10	268
PAF25-05110000	65W-85580-00	107
PAF25-05120000	65W-85570-01	104
PAF25-05130000	62Y-24410-04	85
PAF25-05130005	62Y-24471-00	87
PAF25-05140000	65W-85510-10	121
PAF25-05150000	65W-85550-01	109
PAF25-07000007W	703-48345-01	127
PAF25-07000300W	65W-61350-00	130
PAF4-00000001	90387-06806	285-287
PAF4-00000001	90387-06M14	345
PAF4-00000006	67D-45113-A0	175-217-218
PAF4-01090100	6EG-G2138-00	131
PAF4-01090100	6G1-42138-00	131
PAF4-01090100	6G1-42138-01	131
PAF4-01090300	6EG-G2177-10	134
PAF4-01090300	66E-G2177-00	134
PAF4-01090401	682-82556-00	120
PAF4-02040001	68D-G4360-10	285
PAF4-02040001S	68D-G4360-00	285
PAF4-02040002	68D-G4365	

REF	R.O. / OEM		REF	R.O. / OEM		REF	R.O. / OEM	
PAF4-03060000	6E0-44352-00	64-285	PAF6-04000004	6BX-E1191-00-5B	179	PAGB/T5783-M6X20	97575-06520	293
PAF4-03070000	6E0-45943-01	287	PAF6-04000005	6BX-11356-00	179	PAGB/T5783-M6X20	97595-06520	185-187
PAF4-03070000	6E0-45943-01-EL	285-402	PAF6-04000009	6G0-82519-00	179	PAGB/T5783-M6X20	65W-12228-00	191
PAF4-03080000	6L5-45616-00	283-285-287-405	PAF6-04000020	6BX-F4323-00	179	PAGB/T5783-M6X25	90119-06MA3	187-191-235
PAF4-0310000L	68D-65300-11-4D	277	PAF6-04010004	6BX-E1168-00	179	PAGB/T5783-M6X25	90119-06MA5	191
PAF4-0310000L	68D-65300-10-4D	285	PAF6-04030000	6BX-E2170-00	179	PAGB/T5783-M6X25	90119-08MA5	235
PAF4-0310000S	68D-65300-03-4D	277	PAF6-04050001	6BX-12111-00	179	PAGB/T5783-M6X25	97513-06525	185
PAF4-0310000S	68D-65300-00-4D	285	PAF6-04050002	6AU-12121-00	179	PAGB/T5783-M6X30	90119-06M04	227
PAF4-04000000	680-WE090-11-15	175	PAF6-04050003	60R-12113-00	179	PAGB/T5783-M6X30	90119-06MA4	235
PAF4-04000001	90105-08M76	171	PAF6-04050004	6BX-E2155-00	179	PAGB/T5783-M6X30	90119-06MA5	195
PAF4-04000001	97095-08020	331-335-337-341	PAF6-04050100	6BX-E1111-00-1S	179	PAGB/T5783-M6X30	95895-06035	293
PAF4-04000001	97095-08020-00	177	PAF6-02000007	6C5-44361-00	313	PAGB/T5783-M6X30	970-95-06030	231
PAF4-04000002	68D-11351-A0	177-270	PAF6-04000000	69W-45300-00-4D	278	PAGB/T5783-M6X30	97095-06030	180-211-213-343-346
PAF4-04000003	99510-10114	175-177-179	PAF6-04000000	69W-45300-00-8D	278	PAGB/T5783-M6X35	90105-06035	189
PAF4-04000004	90201-266P2	175	PAF6-04000000	69W-45300-01-8D	278	PAGB/T5783-M6X35	90119-06MA5	243
PAF4-04000006	90201-08818	177	PAF6-04000000	69W-45301-00-8D	311	PAGB/T5783-M6X35	90119-06MA5	191
PAF4-04000006	90201-08818-00	171	PAF6-04000002	69W-45551-00	311	PAGB/T5783-M6X35	95895-06012	343-347
PAF4-04000006	90430-08143	197-209-211	PAF6-04000003	62Y-44151-00	303-307-311	PAGB/T5783-M8X14	97095-08014	171-179
PAF4-04000006	90430-08800	179	PAF6-04000008	63D-45344-00	313	PAGB/T5783-M8X14	97095-08014-00	175
PAF4-04000006	90430-08800-00	175	PAF6-04000101	63D-45321-00	305-309-313	PAGB/T5783-M8X20	97095-08020	179
PAF4-04000006	90201-08818	64-66	PAF6-04000500	62Y-45571-00	311	PAGB/T5783-M8X20	97095-08020-00	177
PAF4-04000007	68D-E5362-00	177	PAF6-04000600	69W-45560-00	311	PAGB/T5783-M8X25	90105-081A7	189
PAF4-04000008	93210-24M79	177-180-185-201-203-205	PAF6-04010000	69W-45501-00	313	PAGB/T5783-M8X25	97075-08025	209
PAF4-04000009	68D-E1169-A0	177	PAF6-04020001	63D-45611-00	303-307-311	PAGB/T5783-M8X25	97080-08025	289-291-292-351
PAF4-04000010	68D-E1168-00	177	PAF6-04020002	90501-18001	303-307-311	PAGB/T5783-M8X25	97095-08025	299-303-307-311-323-329-333-339
PAF4-04000010	68D-E5362-00	179	PAF6-04020003	62Y-45631-00	307-311	PAGB/T5783-M8X30	97575-08530	293
PAF4-04000011	68D-E2414-A0	64-138-173-175-179	PAF6-04020005	63D-45635-00	303-307-311	PAGB/T5783-M8X30	90101-08001	235
PAF4-04000012	90445-09807	175	PAF6-04030000	63D-45361-02-8D	307-311	PAGB/T5783-M8X35	90101-08001	235
PAF4-04000014	67D-11181-A0	175-215-218	PAF6-06000000	6C5-43800-12	124	PAGB/T5783-M8X35	90101-08001	235
PAF4-04000015	67D-12154-00	175	PAF6-06000000	6C5-43800-12	124	PAGB/T5783-M8X35	90101-08001	235
PAF4-04000017	68D-E1193-A0	175	PAF8-05000022	90119-06MA3	187	PAGB/T5783-M8X35	97095-08035	289
PAF4-04000018	67D-11191-00	175	PAF8-05030006	7NJ-12117-00	173-175	PAGB/T5783-M8X35	97095-08035	303-307-311
PAF4-04000019	90280-04M06	193-207	PAF8-05030007	7NJ-12118-00	173-175-179	PAGB/T5787-1986	97575-08550-00	177
PAF4-04000030	90467-08004	75-243	PAGB/T1099-3X5X13	90280-03017	201	PAGB/T6182-M5	90185-05002	289-293-315-319-323-327-331-335-337-341-350
PAF4-04000030	90467-09M09	191-225	PAGB/T1099-3X5X13	90280-03M01	180-185-189-195-203-205	PAGB/T818-M4X10	97607-04210	187
PAF4-04000030	90467-09M09	64-65-67	PAGB/T276-6004C2	93306-004U0	345	PAGB/T818-M4X10	98507-04010	195-197-201-203-205-207
PAF4-04000033	90105-08046-00	175	PAGB/T276-6004C2	93306-004YH	289	PAGB/T818-M4X6	98503-04066-00	177
PAF4-04000034	90105-08M36	173-179-180	PAGB/T276-6004C2	93306-205YD	177	PAGB/T818-M5X12	97095-05012	207
PAF4-04000034	90105-08M36-00	175	PAGB/T276-6006/P6	93306-00612	295	PAGB/T818-M5X12	98780-05016	211
PAF4-04000036	6EE-E5362-00	177	PAGB/T276-62/22/P6	93306-272Y2	171	PAGB/T818-M5X25	97880-05025	173-179-203-205
PAF4-04000038	67D-85640-00	106	PAGB/T290F-2020	93315-220V7	297	PAGB/T818-M5X25	97880-05025	205
PAF4-04010003	68D-E5346-00	177	PAGB/T345.2-D32.5XD1	93210-35537	179	PAGB/T818-M5X25	97880-05025-00	175
PAF4-04010004	93102-25090	177	PAGB/T3452.1-13X2	93210-13M63	64-65-68-69-70-71-180-187-195-201-203-205	PAGB/T818-M5X25	98980-05025	187
PAF4-04010100	68D-E1311-02-15	177	PAGB/T3452.1-25.8X2	93210-22164	355	PAGB/T818-M5X25	98980-05025	187
PAF4-04010102	650-24378-00	173-175-177-179-180-235-237-241	PAGB/T3452.1-25.8X2	93210-26130	297-355	PAGB/T818-M6X16	98580-06016	365
PAF4-04010102	6E9-24378-00	187	PAGB/T3452.1-32.5X1.8	93210-32738	65-66-67-68-69-70-71-180-185	PAGB/T820-M4X12	98780-04015	213-239
PAF4-04020001	68D-E1631-00-96	175	PAGB/T5287.6	90201-06M94	180-185	PAGB/T820-M4X12	98780-04016	187-209-237
PAF4-04020005	68D-E1633-00	175-219	PAGB/T5782-2000S	90119-06M40	285	PAGB/T820-M5X20	90152-05011	293
PAF4-04020006	93450-14088	175-219	PAGB/T5782-M6X125	95895-06035	295	PAGB/T820-M5X25	90152-05M03	289
PAF4-04020100	67D-11650-00	175	PAGB/T5782-M6X125	97013-06035	193-285	PAGB/T820-M5X25	90152-05M04	350
PAF4-04020103	67D-11654-00	175	PAGB/T5782-M6X25	97095-06025	209-213-231	PAGB/T820-M5X30	6E0-W0078-00	345
PAF4-04020200	68D-E1631-00-96	175-219	PAGB/T5782-M6X35	90119-06MA5	191-203-205-233-241	PAGB/T820-M5X30	6E0-W0078-01	345
PAF4-04030000	67D-11400-00	175-219	PAGB/T5782-M6X45	90105-06M25	175	PAGB/T820-M5X30	6E0-W0078-02	345
PAF4-04040000	68D-E2170-00	175	PAGB/T5782-M6X45	947395-06040	349	PAGB/T820-M5X30	90142-05M06	299
PAF4-04050100	68D-E3102-00	177	PAGB/T5782-M8X35	65W-08M87	191	PAGB/T820-M5X30	90151-05M05	295
PAF4-04050200	68D-E5111-00-1S	177	PAGB/T5782-M8X80	90119-08M01	191	PAGB/T820-M5X30	90152-05M06	303-311
PAF4-04060000	6EE-E5396-00-CA	177	PAGB/T5783-M5X10	97013-05010	179	PAGB/T820-M5X30	90152-05M06	307
PAF4-04060001	68D-E5396-00-5B	177-179	PAGB/T5783-M5X12	68D-E5362-00	183	PAGB/T845-ST4.2X16	97780-40112	349
PAF4-04060002	93210-35537	171-177	PAGB/T5783-M5X12	90119-06M48	295	PAGB/T845-ST4.8X9	97780-50510	349
PAF4-04060004	93102-10004	177-179	PAGB/T5783-M5X12	90201-08818	183	PAGB/T848-6	92903-06600	203-205
PAF4-04070000	68D-E2413-00-1S	179	PAGB/T5783-M5X12	90465-08M99	171	PAGB/T861.1-6	92990-06300	293
PAF4-04070001	67D-12413-00-1S	175	PAGB/T5783-M5X12	92995-06600	185-237	PAGB/T861.1-87	92990-06300	283-287-289-295-343-347
PAF4-04070003	68D-E1325-00	64-65-66-67-68-69-70-71-173-175-179	PAGB/T5783-M5X12	93102-25090	183	PAGB/T879.4-3X20	91690-30010	235
PAF4-04070100	68D-E2413-001S	175	PAGB/T5783-M5X12	93306-205YD	183	PAGB/T889.1-2000	90185-05002	295
PAF4-04080005	67D-12111-00	175	PAGB/T5783-M5X12	95895-06016	287-289	PAGB/T889.1-M5	95380-05600	299-303-307-311-365
PAF4-04080006	67D-12121-00	175-180	PAGB/T5783-M5X12	95895-06016-00	285	PAGB/T893.1-22	93420-22M03	287
PAF4-04080007	68T-12116-00	175-179-180	PAGB/T5783-M5X12	95895-06020	283	PAGB/T896-86	93430-06005	343
PAF4-04080008	68D-E2113-00	173-175	PAGB/T5783-M5X12	97013-06016	185-223-229	PAGB/T896-86	99001-06600	283-285-345
PAF4-04080009	68D-E2155-00	175	PAGB/T5783-M5X12	97013-06045	171	PAGB/T896-9	93430-10M00	132
PAF4-04080101	68D-E1111-10-1S	175	PAGB/T5783-M5X12	97095-05012	191	PAGB/T896-9	99080-10600	132
PAF4-04090000	67D-24410-03	85	PAGB/T5783-M5X12	97095-0512	183	PAGB/T91-1.6X12	91490-25030	283-285-287-345
PAF4-04120005	6L5-24251-00	64-80-81-82	PAGB/T5783-M5X12	97095-06035	185	PAGB/T91-1.6X12	91490-30022	64-65-66-295-355-405
PAF4-04120100	67D-24610-00	75	PAGB/T5783-M5X12	97575-08550-00	183	PAGB/T91-2.5X20	91490-30020	349
PAF4-04120100	67D-24610-02	75	PAGB/T5783-M5X16	97095-05016	343	PAGB/T96-10	90201-10M01	293-349
PAF4-04120100	67D-24610-03	75	PAGB/T5783-M6X10	97095-06010	197-349-363	PAGB/T96-6	92995-06600	195
PAF4-04120100	67D-24610-04	75	PAGB/T5783-M6X12	95817-06012	171	PAGB/T97-1.10	92995-10100	299
PAF4-04120100	68D-24610-10	75	PAGB/T5783-M6X12	95817-06012-00	177	PAGB/T97-1.14	92990-14200	355-357-405
PAF4-04120103	624-24634-00	75	PAGB/T5783-M6X12	97013-06012	189	PAGB/T97-1.4	92907-04600	195
PAF4-04130100	6G1-15755-00	113	PAGB/T5783-M6X14	90119-06M80-00	177	PAGB/T97-1.5	92995-05600	191-197-207
PAF4-04130100	6G1-15779-00	113	PAGB/T5783-M6X14	95895-06012	287	PAGB/T97-1.6	92885-06600	177
PAF4-04140000	67D-14301-03	91	PAGB/T5783-M6X16	90105-06039	173	PAGB/T97-1.6	92903-06600	187-197-207
PAF4-05000010	90467-13M13	75	PAGB/T5783-M6X16	90105-06M14	175	PAGB/T97-1.6	92990-06600	185-231-301-343-347-349-367
PAF4-05000300	646-24251-01	80	P					

REF	R.O. / OEM		REF	R.O. / OEM		REF	R.O. / OEM	
PAGB/T97.1-8	92990-08600	367	PAT40-04060005-5	63D-45577-40	299-303-307-311	PH130-0076	6C9-81800-00	112
PAGB/T97.1-8	92990-14200	295				PH130-0076	6D0-81800-00	112
PAGB/T97.1-8	92995-05600	183-203-205	PAT40-04060005-6	63D-45577-50	299-303-307-311	PH130-0084	66M-81800-00	110
PAGB/T97.1-8	92995-06600	185-227-229-233-241				PH130-0084	66M-81800-01	110
		179-209-214-325-329-333-335-337-341-343-363-369-377	PAT40-04060005-7	63D-45577-60	299-303-307-311	PH130-0084	66M-81800-02	110
PAGB/T97.1-8	92995-08600	295-299-303-307-311-315-319-331				PH200-T029	6H1-43880-02	122
PAGB/T97.1-8	92995-10600	307-311-315-319-331	PAT40-04070000	69W-45941-00-EL	402	PH200-T030	6G5-43880-00	123
PAGB/T97.1-8	93102-20108	183	PAT40-05000100	6AH-82560-00	103	PH200-T030	6G5-43880-01	123
PAGB/T97.1-8	97595-06520	183-191-193-283	PAT40-10000000	65W-43800-00-4D	124	PH200-T030	6G5-43880-02	123
PAGBT3452.1-97.5X1.8	65W-15663-00	191	PAT40-10000000	65W-43800-01-4D	124	PH200-T035	62X-43880-00	122
PAHI-CAP32004JRKYOYO	93332-000W5	297	PAT40-10000000	65W-43800-02-4D	124	PH200-T035	62X-43880-01	122
PAHT-2.5X50	90465-11M10	293	PAT40-10000000	65W-43800-03-4D	124	PH200-T035	62X-43880-09	122
		180-191-197-207-209-213-301-305-309-313-317-321-325	PAT40-10000000	65W-43800-20-4D	124	PH200-T036	62Y-43880-01	122
PAHT-2.5X60	90465-11M10	221-225-231-237-239-241	PAT40-10000000	65W-43800-21-4D	124	PH200-T036	62Y-43880-02	122
		187	PAT40-10000000	65W-43800-22-8D	124	PH200-T036	62Y-43880-09	122
PAHT2.5X50	90465-11M10	335-339	PAT40-10000000	65W-43800-23-8D	124	PH200-T036	69W-43880-00	122
PAJASOF404-19-033	93210-33M49	64-154-283	PAT40-10000000	65W-43800-22-8D	124	PH200-T036	69W-43880-01	122
PAJASOF404-19-033	93210-33M85	351	PAT40-10000000	65W-43800-23-8D	124	PH200-T036	CS3-43880-00	122
PAJASOF404-31-045	93210-44398	313	PAT40-10020500	65W-43880-00	123	PH200-T037	688-43880-11	123
PAJASOF40424-050	93210-48001	64-65-69-70-171-181-187-191-195-197-207-209-211-213-214	PAT40-10020500	65W-43880-01	123	PH200-T037	6E5-43880-00	123
		175-185-199-203-205-207-213	PAT85-00000012	90105-10M00	323-327-331-335-337-375-379	PH200-T037	6E5-43880-01	123
PAJB/T9740.1-M6	93700-06M03	133				PH200-T037	6E5-43880-02	123
PAJISB2401P48	93210-48214	283-285	PAT85-00000012	90105-16M67	315-319	PH200-T041	6H1-43880-00	122
PAKOYOHI-CAP322/32	93332-00092	311	PAT85-00000017	90386-18M35	133	PH200-T044	67F-43880-00	123
PANTN16003EY	93316-003Y0	283	PAT85-01010203	90386-10M16	133	PH200-T045	6C5-43880-00	123
PANTN6205C3	93306-205B2	179	PAT85-01020003	90386-30M78	133	PH200-T045	6C5-43880-01	123
		175-185-199-203-205-207-213	PAT85-01020003	90386-30M77	133	PH200-T048	6H5-43880-00	122
PAPS2700.04.03	51Y-12119-00	213	PAT85-040000003-B	688-45587-01	317-321	PH200-T048	6H5-43880-01	122
		235	PAT85-040000004-B	688-45567-01	315-319	PH200-T048	6H5-43880-02	122
PAT15-04010202	62A-14485-00	235	PAT85-05000023	6C5-82105-01	112	PH200-T048	6H5-43880-09	122
PAT15-04010202	6H1-14485-00	171	PAT85-05000023	6H0-82105-02	112	PH200-T050	61A-43880-00	124
PAT20-13000500W	703-48861-11	1276	PAT85-05000023	6H0-82105-J2	112	PH200-T050	61A-43880-01	124
PAT36-04000023	90465-06M86	179	PAT85-05030300	6AH-81960-00	116	PH200-T057	67H-43880-00	123
		301-305-309-313-317-321-367-371	PAT85-08010000W	703-48205-10	126	PH200-T057	68W-43880-03	123
PAT40-02000002	663-44367-00	301-305-309-313	PAT85-08010100	688-8258A-20	128	PH200-T057	6AE-43880-00	123
		313	PH130-0005	6E5-81800-10	110	PH200-T057	6AE-43880-01	123
PAT40-04000002	6H4-45536-00	309	PH130-0005	6E5-81800-11	110	PH200-T057	6AE-43880-03	123
PAT40-04000003-1	663-45587-01	367	PH130-0005	6E5-81800-12	110	PH200-T057	6AE-43880-04	123
PAT40-04000003-1	663-45587-01-10	367	PH130-0007	676-81800-10	111	PH200-T068	6D8-43880-00	123
PAT40-04000003-2	663-45587-01-12	367	PH130-0007	697-81800-10	111	PH200-T068	6D8-43880-09	123
PAT40-04000003-2	663-45587-10	309	PH130-0007	697-81800-11	111	PH200-T069	60V-43880-00	123
PAT40-04000003-3	663-45587-01-15	367	PH130-0007	697-81800-12	111	PH200-T069	69J-43880-00	123
PAT40-04000003-3	663-45587-20	309	PH130-0007	99999-03249	111	PH200-T069	69J-43880-01	123
PAT40-04000003-4	663-45587-01-18	367	PH130-0028	67C-81800-01	110	PH200-WH01	65W-81941-00	111-114
PAT40-04000003-4	663-45587-30	309	PH130-0028	67C-81800-02	110	PH375-0034	65W-81941-00	110
PAT40-04000003-5	663-45587-01-30	367	PH130-0029	67C-81800-01	110	PH375-0036	68N-81940-00	114
PAT40-04000003-5	663-45587-40	309	PH130-0029	65W-81800-00	111	PH375-0042	68V-8194A-00	114
PAT40-04000003-6	663-45587-01-40	367	PH130-0029	65W-81800-02	111	PH375-0042	6E5-81950-01	110-115
PAT40-04000003-6	663-45587-50	309	PH130-0029	65W-81800-03	111	PH375-0047	6E5-8195A-01	115
PAT40-04000003-7	663-45587-01-50	367	PH130-0034	66M-81800-01	111	PH375-0048	6E5-8195C-01	115
PAT40-04000003-7	663-45587-60	309	PH130-0034	66M-81800-02	111	PH375-0048	69M-WE0090-01-1S	173
		299-303-307-311	PH130-0049	689-81800-10	110	POWERHEAD2.6		193
PAT40-04000004-1	663-45567-01	311	PH130-0049	689-81800-11	110	POWERHEAD20-25		193
PAT40-04000004-1	663-45567-01-10	365	PH130-0049	689-81800-12	110	PRE3300C05	YMM-21005-00-00	130
PAT40-04000004-2	663-45567-01-12	365	PH130-0049	689-81800-13	110	PRE3300C06	YMM-21006-C8-00	130
		299-303-307-311	PH130-0049	6H3-81800-10	111	PRE3300C07	YMM-21007-C8-00	130
PAT40-04000004-2	663-45567-10	311	PH130-0050	6H3-81800-11	111	PRE3300C08	YMM-21008-C8-00	130
PAT40-04000004-3	663-45567-01-15	365	PH130-0051	61H-81800-00	110	PRE3300C09	YMM-21009-C8-00	130
		299-303-307-311	PH130-0051	61H-81800-01	110	PRE3300C10	YMM-21010-C8-00	130
PAT40-04000004-3	663-45567-20	311	PH130-0051	61H-81800-01	110	PRE3300C11	YMM-21011-C8-00	130
		299-303-307-311	PH130-0051	6K7-81800-10	110	PRE3300C12	YMM-21012-C8-00	130
PAT40-04000004-5	663-45567-01-30	365	PH130-0051	6N7-81800-00	110	PRE3300C13	YMM-21013-C8-00	130
		299-303-307-311	PH130-0051	6N7-81800-01	110	PRE3300C14	YMM-21014-C8-00	130
PAT40-04000004-5	663-45567-40	311	PH130-0051	6N7-81800-10	110	PRE3300C15	YMM-21015-C8-00	130
		299-303-307-311	PH130-0051	99999-03938	110	PRE3300C16	YMM-21016-C8-00	130
PAT40-04000007	66T-45321-00	301	PH130-0055	67F-81800-02	112	PRE3300C17	YMM-21017-C8-00	130
		301-305-309-313	PH130-0055	67F-81800-03	112	PRE3300C18	YMM-21018-C8-00	130
PAT40-04000008	90201-27M00	301-305-309-313	PH130-0055	67F-81800-04	112	PRE3300C19	YMM-21019-C8-00	130
		301-305-309-313	PH130-0056	68F-81800-00	111	PRE3300C20	YMM-21020-C8-00	130
PAT40-04000009	66T-45344-01	301-305-309-313	PH130-0056	68F-81800-01	111	PRE3300C21	YMM-21021-C8-00	130
		301-305-309-313	PH130-0056	68F-81800-03	111	PRE3300C22	YMM-21022-C8-00	130
PAT40-04000014	63D-45375-00	301-305-309-313	PH130-0056	6C5-81800-00	111	PRE3300C23	YMM-21023-C8-00	130
		299-303-307-311	PH130-0056	6CJ-81800-00	111	PRE3300C24	YMM-21024-C8-00	130
PAT40-04000022	63D-45214-00	299-303-307-311	PH130-0057	68V-81800-00	111	PRE3300C25	YMM-21025-C8-00	130
		299-303-307-311	PH130-0057	68V-81800-01	111	PRE3300C26	YMM-21026-C8-00	130
PAT40-04000023	63D-45215-00	299-303-307-311	PH130-0057	68V-81800-02	111	PRE3300C27	YMM-21027-C8-00	130
		299-303-307-311	PH130-0057	688-81800-10	111	PRE3300C28	YMM-21028-C8-00	130
PAT40-04000027	93332-00079	367	PH130-0058	688-81800-11	111	PRE3300C29	YMM-21029-C8-00	130
PAT40-04000003-1	663-45587-01	301-305-313	PH130-0058	688-81800-12	111	PRE3300C30	YMM-21030-C8-00	130
PAT40-04000003-2	663-45587-10	301-305-313	PH130-0059	61A-81800-00	110			
PAT40-04000003-3	663-45587-20	301-305-313	PH130-0059	61A-81800-01	110	RAC120R-RAC-01	YMM-2W114-00	79
PAT40-04000003-4	663-45587-30	301-305-313	PH130-0061	61A-81800-02	110	RAC320R-RAC-01	YMM-2W227-01	78
PAT40-04000003-5	663-45587-40	301-305-313	PH130-0061	682-81800-10	110	RAC320R-RAC-03		78
PAT40-04000003-6	663-45587-50	301-305-313	PH130-0061	682-81800-11	110	RAC490R-RAC-01	YMM-2W227-01	79
PAT40-04000003-6	663-45587-60	301-305-313	PH130-0061	682-81800-12	110	RACPF5510		77
PAT40-04000003-7	663-45587-70	301-305-313	PH130-0061	6L2-81800-10	110	RACRK22628		79
PAT40-04000003-7	663-45587-80	301-305-313	PH130-0061	6L2-81800-11	110	RACS3213	MAR-24563-00	78
PAT40-04000003-7	663-45587-90	301-305-313	PH130-0061	6L2-81800-12	110	RACS3227	YMM-2E227-00	79
PAT40-040000201	66T-44311-00	148-301-305	PH130-0062	6F5-81800-10	110	RACS3227	YMM-2E227-01	79
PAT								

REF	R.O. / OEM	
REC25000		77
REC25010		77
REC25020		77
REC25030		77
REC25W40U3		84
REC2TU3	YMD-63021-04	84
REC2TU6	YMD-63021-01	84
REC35-802893Q		77
REC35-802893Q01		77
REC35-80365M	646-24251-01	80
REC35-80365M	646-24251-02	80-82-83
REC35-822626Q15	69J-13440-00	83
REC35-822626Q15	69J-13440-01	83-211-213
REC35-822626Q15	69J-13440-03	71-72-73-83
REC3FV-13440-00	3FV-13440-00	83
REC3FV-13440-00	3FV-13440-10	83
REC3FV-13440-00	3FV-13440-20	83
REC3FV-13440-00	3FV-13440-30	67-83
REC40135		80
REC40145	65W-24251-00	82
REC40145	65W-24251-10	80
REC40145		65-67-81
REC40155		80
REC40165	67F-24251-02	80-81-82
REC405-A20	6E5-45300-16-8D	375
REC405-A20	6E5-45300-17-8D	280
REC405-A25	6E5-45300-26-8D	375
REC405-A25	6E5-45300-27-8D	280
REC40970		121
REC40990		121
REC416-A20	64D-45300-01-8D	280
REC416-A20	64D-45300-02-8D	379
REC416-A25	64D-45300-21-8D	280
REC416-A25	64D-45300-22-8D	379
REC416-B20	64K-45300-02-NA	281
REC416-B20F	63P-45300-00-8D	278
REC416-B20F	63P-45300-02-8D	327
REC416-B25F	63P-45300-10-8D	278
REC416-B25F	63P-45300-12-8D	327
REC418-A25	64P-45300-10-8D	280
REC418-B25F	64P-45300-10-8D	278
REC418-B25F	64P-45300-12-8D	327
REC421-A20	66K-45300-12-NA	281
REC421-A25	60V-45300-20-8D	281
REC421-B25F	69J-45300-21-8D	279
REC421-B25F	69J-45300-22-8D	331
REC421-B30F	69J-45300-32-8D	279
REC422-B25F	6P2-45300-20-8D	278-339
REC422-B25F	6P2-45300-21-8D	278-339
REC422-B25F	6P2-45300-40-8D	278
REC422-B25F	6P2-45300-41-8D	278
REC422-B25F	6P245300208D	278
REC422-B25F	6P245300218D	278
REC422-B25F	6P245300408D	278
REC422-B25F	6P245300418D	278
REC428-A25	60W-45300-20-8D	281
REC428-B25F	69K-45300-21-8D	279
REC428-B30F	69K-45300-34-8D	279
REC429-B25F	6P3-45300-40-8D	278-339
REC429-B25F	6P3-45300-41-8D	278-339
REC429-B25F	6P3-45300-42-8D	278
REC429-B25F	6P345300408D	278
REC429-B25F	6P345300418D	278
REC429-B25F	6P345300428D	278
REC48630-92J00	61A-43811-00	125
REC48630-92J00	63P-43811-10	125
REC48630-92J00	63P-43811-20	125
REC48630-92J00	64E-43811-02	125
REC48630-92J00	64E-43821-05	125
REC48630-92J00	6AW-4380R-01	125
REC48630-92J00	6EK-4380R-00	125
REC48630-94900	61A-43821-00	125
REC48630-94900	61A-43821-01	125
REC48630-94900	61A-43821-09	125
REC48630-94900	67F-4380R-00	125
REC48630-94900	67F-4380R-01	125
REC48630-94900	67F-43811-00	125
REC48630-96J03	64E-43820-00	125
REC48630-96J03	64E-43820-08	125
REC48630-96J03	64E-43820-09	125
REC48630-96J03	64E-43820-09	125
REC48630-96J03	64E-43820-08	125
REC48630-96J03	64E-43820-09	125
REC48630-96J03	64E-43820-09	125
REC48630-96J03	64E-43821-08	125
REC48630-96J03	6AW-4380R-00	125
REC50M-14355-00	50M-14355-00	99
REC5GH-13440-00	5GH-13440-00	83-183-191-197-209
REC5GH-13440-00	5GH-13440-10	207
REC5GH-13440-00	5GH-13440-30	83
REC5GH-13440-00	5GH-13440-70	83
REC5GH-13440-00	5GH-13440-70	65-66-67-68-69-70-71-83
REC5GH-13440-60	5GH-13440-20	195-203
REC5GH-13440-60	5GH-13440-50	83-201-205
REC5GH-13440-60	5GH-13440-60	83-187
REC5GH-13440-60	5GH-13440-60	65-66-67-68-69-83
REC5W40U3		84
REC5W40U6		84
REC60E-81950-00	60E-81950-00	115
REC60H-12416-00	60H-12416-00	245-247
REC60H-12416-00	6G5-12416-00	209-211

REF	R.O. / OEM	
REC60V-11181-00	60V-11181-00	249-254
REC60V-12411-00	60V-12411-00	70-137
REC60V-13621-A0	60V-13621-A0	276
REC60V-13645-00	60V-13645-00	276
REC60V-13907-00	60V-13907-00	86
REC60V-24251-01	60V-24251-01	82
REC60V-44150-00	60V-44150-00	385
REC60V-45113-02	60V-45113-02	254
REC60V-45332-00-94	60V-45332-00-94	383
REC60V-45611-00	60V-45611-00	383
REC60V-81950-00	60V-81950-00	115
REC60V-81960-05	60V-81960-05	117
REC60V-81960-05	60V-81960-01	117
REC60V-81960-05	60V-81960-02	117
REC60V-81960-05	60V-81960-03	117
REC60V-81960-05	60V-81960-04	117
REC60V-81960-05	60V-81960-05	117
REC60X-44315-A0	60X-44315-A0	339-386
REC60X-W0078-00	60X-W0078-00	153-157-386
REC61A-11181-A0	61A-11181-00	249-254
REC61A-11193-A2	61A-11193-A2	255
REC61A-11381-A0	61A-11381-A0	276
REC61A-11650-00	61A-11650-00	261
REC61A-12414-A0	61A-12414-A0	138-231
REC61A-12414-A0	61A-12414-A0	237
REC61A-13411-00	61A-13411-00	83
REC61A-13621-A0	61A-13621-A0	276
REC61A-13645-00	61A-13645-00	276
REC61A-13646-00	61A-13646-00	276
REC61A-24563-00	61A-24563-00	81-82
REC61A-41134-A0	60D-41134-00	272
REC61A-44311-00	61A-44311-00	385
REC61A-44311-00	61A-44311-01	325-329-333-339-377-381-386
REC61A-44311-00	6E5-44311-00	148
REC61A-44311-00	61A-44311-00	155-156-157-158-159-160-161-162-163-164-165-166-167-168-169-170-171-172-173-174-175-176-177-178-179-180-181-182-183-184-185-186-187-188-189-190-191-192-193-194-195-196-197-198-199-200-201-202-203-204-205-206-207-208-209-210-211-212-213-214-215-216-217-218-219-220-221-222-223-224-225-226-227-228-229-230-231-232-233-234-235-236-237-238-239-240-241-242-243-244-245-246-247-248-249-250-251-252-253-254-255-256-257-258-259-260-261-262-263-264-265-266-267-268-269-270-271-272-273-274-275-276-277-278-279-280-281-282-283-284-285-286-287-288-289-290-291-292-293-294-295-296-297-298-299-300-301-302-303-304-305-306-307-308-309-310-311-312-313-314-315-316-317-318-319-320-321-322-323-324-325-326-327-328-329-330-331-332-333-334-335-336-337-338-339-340-341-342-343-344-345-346-347-348-349-350-351-352-353-354-355-356-357-358-359-360-361-362-363-364-365-366-367-368-369-370-371-372-373-374-375-376-377-378-379-380-381-382-383-384-385-386-387-388-389-390-391-392-393-394-395-396-397-398-399-400-401-402-403-404-405-406-407-408-409-410-411-412-413-414-415-416-417-418-419-420-421-422-423-424-425-426-427-428-429-430-431-432-433-434-435-436-437-438-439-440-441-442-443-444-445-446-447-448-449-450-451-452-453-454-455-456-457-458-459-460-461-462-463-464-465-466-467-468-469-470-471-472-473-474-475-476-477-478-479-480-481-482-483-484-485-486-487-488-489-490-491-492-493-494-495-496-497-498-499-500-501-502-503-504-505-506-507-508-509-510-511-512-513-514-515-516-517-518-519-520-521-522-523-524-525-526-527-528-529-530-531-532-533-534-535-536-537-538-539-540-541-542-543-544-545-546-547-548-549-550-551-552-553-554-555-556-557-558-559-560-561-562-563-564-565-566-567-568-569-570-571-572-573-574-575-576-577-578-579-580-581-582-583-584-585-586-587-588-589-590-591-592-593-594-595-596-597-598-599-600-601-602-603-604-605-606-607-608-609-610-611-612-613-614-615-616-617-618-619-620-621-622-623-624-625-626-627-628-629-630-631-632-633-634-635-636-637-638-639-640-641-642-643-644-645-646-647-648-649-650-651-652-653-654-655-656-657-658-659-660-661-662-663-664-665-666-667-668-669-670-671-672-673-674-675-676-677-678-679-680-681-682-683-684-685-686-687-688-689-690-691-692-693-694-695-696-697-698-699-700-701-702-703-704-705-706-707-708-709-710-711-712-713-714-715-716-717-718-719-720-721-722-723-724-725-726-727-728-729-730-731-732-733-734-735-736-737-738-739-740-741-742-743-744-745-746-747-748-749-750-751-752-753-754-755-756-757-758-759-760-761-762-763-764-765-766-767-768-769-770-771-772-773-774-775-776-777-778-779-780-781-782-783-784-785-786-787-788-789-790-791-792-793-794-795-796-797-798-799-800-801-802-803-804-805-806-807-808-809-810-811-812-813-814-815-816-817-818-819-820-821-822-823-824-825-826-827-828-829-830-831-832-833-834-835-836-837-838-839-840-841-842-843-844-845-846-847-848-849-850-851-852-853-854-855-856-857-858-859-860-861-862-863-864-865-866-867-868-869-870-871-872-873-874-875-876-877-878-879-880-881-882-883-884-885-886-887-888-889-890-891-892-893-894-895-896-897-898-899-900-901-902-903-904-905-906-907-908-909-910-911-912-913-914-915-916-917-918-919-920-921-922-923-924-925-926-927-928-929-930-931-932-933-934-935-936-937-938-939-940-941-942-943-944-945-946-947-948-949-950-951-952-953-954-955-956-957-958-959-960-961-962-963-964-965-966-967-968-969-970-971-972-973-974-975-976-977-978-979-980-981-982-983-984-985-986-987-988-989-990-991-992-993-994-995-996-997-998-999-1000

REF	R.O. / OEM	
REC61N-44322-00	61N-44322-01	154-155-297-355
REC61N-44323-00	61N-44323-00	149-154-155-297-355
REC61N-45510-00	61N-45510-00	355-388-389
REC61N-45510-10	61N-45510-10	355-388-389
REC61N-45551-00	61N-45551-00	355-388-389
REC61N-45560-10	61N-45560-00	295
REC61N-45560-10	61N-45560-10	355-388-389
REC61N-45570-00	61N-45571-00	355-388-389
REC61N-85540-00	61N-85540-00	119
REC61N-85570-01	61N-85570-01	105
REC61N-85570-01	61N-85570-01	105
REC61N-W0001-E1	61N-W0001-E1	145-354
REC61N-W0078-11	61N-W0078-11	150
REC61N-W0078-11	61N-W0078-11	65-66-150-154-155-297-354
REC61N-W0093-00	61N-W0093-00	93-96-229
REC61T-11193-A0	61T-11193-A1	229-255
REC61T-45113-A0	61T-45113-A0	253
REC61T-45113-A0	689-45113-A1	229
REC61T-45113-A0	61T-45113-A0	254
REC61T-W0001-02	61T-W0001-02	229-250-254-266-267-221-225-227-231-233-237-239-241-243
REC624-14485-00	624-14485-00	
REC624-42542-00	90387-06119	98
REC626-14390-90	626-14390-90	98
REC626-44365-01	626-44365-01	349-353
REC626-45316-09	626-45316-09	291-292-349
REC626-45316-09	90381-14020	351
REC62Y-15312-00	62Y-15312-00	271
REC62Y-41133-00	62Y-41133-00	268
REC62Y-45127-00	62Y-45127-00	268
REC62Y-46241-00	62Y-46241-00	207-267
REC62Y-W0001-22	62Y-W0001-20	146
REC62Y-W0001-22	62Y-W0001-21	146
REC62Y-W0001-22	62Y-W0001-22	146-306
REC634-11633-00	634-11633-00	227-260-262
REC63D-11181-A1	63D-11181-A2	237-248-254
REC63D-11193-A0	63D-11193-A0	237-255
REC63D-11603-00	63D-11603-00	237-263
REC63D-11605-00	63D-11605-00	237-263
REC63D-44311-01	63D-44311-00	148-156-309-313
REC63D-44312-00	63D-44312-00	301-305-309-313-317-361
REC63D-44316-00	63D-44316-00	301-305-309-313-361
REC63D-44322-00	63D-44322-00	154-156-301-305-309-313-317-361
REC63D-44323-00	63D-44323-00	305-309-313
REC63D-44323-00	63D-44323-00-00	149
REC63D-44323-00	63D-44323-00	154-156
REC63D-44341-00	63D-44341-00	301-309-361
REC63D-45114-A0	63D-45114-A0	272
REC63D-45123-00	63D-45123-00	269

REF	R.O. / OEM	
REC63P-82380-00	63P-82380-00	90-102
REC63V-11181-A1	63V-11181-A1	248
REC63V-11181-A1	63V-11181-A2	227-254
REC63V-11412-00	63V-11412-00	227-256
REC63V-11422-00	63V-11422-00	227-256
REC63V-11432-00	63V-11432-00	227-256
REC63V-11442-00	63V-11442-00	227-256
REC63V-11445-00	63V-11445-00	227
REC63V-11515-02	63V-11515-02	227
REC63V-14126-00	63V-14126-00	94
REC63V-14301-00	63V-14301-00	93
REC63V-14984-00	63V-14984-00	94
REC63V-14985-00	63V-14985-00	93-100
REC63V-15396-01-CA	63V-15396-01-CA	227
REC63V-24411-00	63V-24411-00	87
REC63V-41111-00-1S	63V-41111-00-1S	227
REC63V-41112-A0	63V-41112-A0	140-227
REC63V-41113-00-1S	63V-41113-00-1S	227
REC63V-41133-A1	63V-41133-A1	268
REC63V-44301-00	63V-44301-00	289-291-351
REC63V-44301-00-00	63V-44301-00-00	147
REC63V-44301-00	63V-44301-00	154-155
REC63V-44322-00	63V-44322-00	154-155-289-291-293-351
REC63V-44323-00	63V-44323-00	351
REC63V-44323-00-00	63V-44323-00-00	149
REC63V-44352-01	63V-44352-01	143-154-155-291-293-351
REC63V-44361-01	63V-44361-01	351
REC63V-44361-11	63V-44361-11	351
REC63V-44514-01-CA	63V-44514-01-CA	135
REC63V-45113-A1	63V-45113-A1	227-253-254
REC63V-45300-03-8D	63V-45300-03-8D	279
REC63V-45300-03-8D	63V-45300-03-8D	279
REC63V-45300-03-8D	63V-45300-03-8D	279
REC63V-45300-10-4D	63V-45300-10-4D	279
REC63V-45300-13-8D	63V-45300-13-8D	279
REC63V-45300-13-8D	63V-45300-13-8D	279
REC63V-45315-A0	63V-45315-A0	291-351
REC63V-45331-00-5B	63V-45331-00-5B	291-351
REC63V-45501-10	63V-45501-10	291-387-388
REC63V-45501-01	63V-45501-01	351-387-388
REC63V-45501-11	63V-45501-11	351-387-388
REC63V-45551-00	63V-45551-00	291-293-351-387-388
REC63V-85520-00	63V-85520-00	106
REC63V-85533-00	63V-85533-00	104
REC63V-85540-00-01	63V-85540-00-01	118-119
REC63V-85540-00-01	63V-85540-00-01	118-119
REC63V-85540-00-01	63V-85540-02	118
REC63V-85570-00	63V-85570-00	105
REC63V-85570-00	63V-85570-00	105
REC63V-85580-01	63V-85580-01	107
REC63V-W0001-00	63V-W0001-00	226
REC63V-W0001-00	63V-W0001-01	249-254
REC63V-W0001-21	63V-W0001-21	144
REC63V-W0078-01	63V-W0078-01	150
REC63V-W0078-01	63V-W0078-01	65-154-155-290-350
REC63V-W0093-00	63V-W0093-00	93-95-226
REC63W-13610-00	63W-13610-00	92-99
REC646-11633-00	646-11633-00	220
REC646-11651-02	646-11651-02	220-260
REC646-11681-00	646-11681-00	220-260
REC646-14623-A1	646-14623-A1	220-254-270
REC646-44322-00	646-44322-00	343
REC646-44323-00	646-44323-00	148-155-343
REC646-44352-01	646-44352-01	143-155-343
REC646-44365-00	646-44365-00	343
REC646-44366-01	646-44366-01	343
REC646-45551-00	646-45551-00	343-387
REC646-45560-00	646-45560-00	343-387
REC647-11610-00	647-11610-00	225-262-266
REC647-11610-10	647-11610-10	225
REC647-11610-20	647-11610-20	225
REC647-14323-00	647-14323-00	98
REC647-14385-00	647-14385-00	100
REC647-14386-10	647-14386-10	99
REC647-44366-00	647-44366-00	154-155-291-346-347-351
REC647-45316-09	647-45316-09	347
REC647-45551-00	647-45551-00	347-387
REC647-45560-00	647-45560-00	347-387
REC647-45570-00	647-45570-01	347-387
REC647-45616-02	647-45616-02	345
REC648-11633-00	648-11633-00	237-260-261-263-264
REC648-11651-00	648-11651-00	260-261
REC648-11681-00	648-11681-00	260
REC648-13621-A0	648-13621-A1	273
REC648-13645-A0	648-13645-A0	273
REC648-14198-A0	648-14198-A0	274
REC648-14384-01-00	648-14384-01	94
REC648-14385-00	648-14385-00	100
REC648-24411-00	648-24411-00	87
REC648-24434-01	648-24434-01	88
REC648-24435-02	648-24435-02	88
REC648-44146-00	648-44146-00	134
REC648-45633-00	648-45633-00	291-295-349-351-353-355-357
REC648-45633-00	648-45633-11	293
REC648-45633-00	648-45633-11	387-388-389
REC648-45635-00	648-45635-00	295-353-355
REC64D-11603-01	64D-11603-01	245

REF	R.O. / OEM	
REC64D-11603-01	64D-11603-02	247-265-266-267
REC64D-11604-01	64D-11603-04	265
REC64D-11604-01	64D-11604-01	245-247
REC64D-11604-01	64D-11604-02	247
REC64D-11605-01	64D-11603-05	265
REC64D-11605-01	64D-11605-01	245
REC64D-11605-01	64D-11605-02	247
REC64D-11631-00K	64D-11631-02-90	247-265-267
REC64D-11642-00K	64D-11642-02-90	247-265-267
REC64D-14384-1	64D-14384-01	94
REC64D-14394-00	64D-14394-00	99
REC64D-W0093-00	64D-W0093-00	97-247
REC64E-13645-A0	64E-13645-A0	276
REC64E-43821-05	64E-43821-00	125
REC64E-43822-00	64E-43822-00	125
REC64E-4384J-00	64E-4384J-00	125
REC64J-24560-10	64J-24560-10	80
REC64J-24560-10	64J-24560-10	80
REC64J-W0001-20	64J-W0001-20	145-146-333
REC64J-W0001-21	64J-W0001-21	146-333
REC650-11370-00	650-11370-00	231
REC650-11370-00	650-11370-01	225-235-237-239-241-243
REC650-11651-04	650-11651-00	227-260
REC650-14485-03	650-14485-03	227
REC650-24351-51	650-24351-00	75
REC650-24351-51	650-24351-01	75
REC650-24351-51	650-24351-50	75
REC650-24351-51	650-24351-51	75
REC650-24431-A0	650-24431-A0	88
REC650-44147-00	650-44147-00	134-363-367
REC650-45635-00	650-45635-00	291-293-349-351
REC655-12414-A1	655-12414-A1	138-229
REC65L-13645-00	65L-13645-00	275
REC65L-13646-00	65L-13646-00	275
REC65L-13915-00	65L-13915-00	82
REC65L-24563-00	65L-24563-00	71-72-81-82
REC65N-45321-00	65N-45321-00	335
REC65N-W0078-A1	65N-W0078-A1	152-157
REC65W-46241-00	65W-46241-00	193-199-267
REC65W-82575-01	65W-82575-01	120
REC65W-W0001-00	65W-W0001-00	217
REC65W-W0001-00	65W-W0001-02	190
REC65W-W0001-00	65W-W0001-02	218
REC65W-W0001-20	65W-W0001-20	145-297
REC662-44352-01	662-44352-01	143-347
REC663-11193-00	663-11193-A0	239-255
REC663-11411-01	663-11411-01	239-256
REC663-11561-00	663-11561-00	239
REC663-11633-00	663-11633-00	239-243-260-261-264
REC663-11634-00	663-11634-00	233-263
REC663-11634-00	663-11634-00	235-263
REC663-12414-A0	663-12414-A0	138-239
REC663-12416-00	663-12416-00	235-239
REC663-13621-01	663-13621-A0	275
REC663-14198-00	663-14198-A0	275
REC663-14483-A0	663-14483-A0	275
REC663-14548-00	663-14548-00	99
REC663-14923-00	663-14923-00	99
REC663-24411-00	663-24411-00	87
REC663-41114-00	663-41114-A0	142-239
REC663-42138-00	663-42138-00	130
REC663-43118-01-4D	663-43118-01-4D	134
REC663-44144-01	663-44144-01	369-371
REC663-44151-00	663-44151-00	369-371
REC663-44311-02	663-44311-02	359-369
REC663-44311-02	663-44311-02-00	147
REC663-44311-02	663-44311-02	369
REC663-44311-02	663-44311-02	357
REC663-44311-02	663-44311-02	155-156
REC663-44315-A0	663-44315-A0	155-156-357-359-369
REC663-44316-A0	663-44316-A0	357-359-369
REC663-44322-00	663-44322-00	154-155-156-357-359-369
REC663-44323-00	663-44323-00	149-155-156-357-359-369
REC663-44324-00	663-44324-A0	357-359-369
REC663-44366-00	663-44366-00	301-305-309-313-317-321-333-357-359-361-363-367-369-371-373-385
REC663-44366-00	663-44366-00	154-155-156
REC663-44551-02-8D	663-44551-02-8D	135
REC663-45123-00	663-45123-00	268
REC663-45331-00-94	663-45331-00-94	369-390
REC663-45375-00	663-45375-00	367
REC663-45376-00	663-45376-00	305-325-335-367
REC663-45376-00	663-45376-00-94	301-309-313-317-321-329
REC663-45510-01	663-45510-01	369-390
REC663-45552-00	663-45552-00	359-365-369
REC663-45576-00	663-45576-00	365
REC663-45631-01	663-45631-01	359-363-365-369-389-390
REC663-45633-00	663-45633-00	359-361-363-365-369-389-390
REC663-45634-00	663-45634-00	303-307-311-359-363-365-369

REF	R.O. / OEM	
REC663-45987-00	663-45987-00	365
REC663-45987-00	663-45987-02	299-303-307-311-359-361-369
REC663-45987-00	663-45987-02	405
REC663-48344-00	663-48344-00	127
REC663-85518-00	633-85518-00	132
REC663-85540-11	663-85540-11	119
REC663-85540-15	663-85540-15	119
REC663-W0078-01	663-W0078-00	368
REC663-W0078-01	663-W0078-01	152-368
REC663-W0078-01	663-W0078-A0	151
REC663-W0078-01	663-W0078-A0	156
REC664-41114-A0	664-41114-A0	140
REC664-41134-A0	664-41134-A0	268
REC664-44338-00	63V-44338-00	351
REC664-44338-00	664-44338-00	289-291-293-353
REC664-44338-00	664-44338-00	154-155
REC664-45384-00	664-45384-00	353-357
REC664-45631-00	664-45631-02	355-388-389
REC664-45631-01	664-45631-01	353
REC664-45987-00	664-45987-00	353
REC66K-13907-00	66K-13907-00	86
REC66K-13915-00	66K-13915-00	82
REC66K-14984-00	66K-14984-00	86-88
REC66K-45501-00	66K-45501-00	385
REC66M-46241-00	66M-46241-00	185-267
REC66M-W0001-01	66M-W0001-01	182-216-218
REC66M-W0001-20	66M-W0001-20	144-290
REC66M-W0093-01	66M-W0093-01	95-182
REC66N-11603-00	66N-11603-00	183-219
REC66T-11181-00	66T-11181-A0	249
REC66T-11181-00	66T-11181-A2	233-254
REC66T-11193-A0	66T-11193-A0	233-255
REC66T-11412-00	66T-11412-00	233-256
REC66T-11422-00	66T-11422-00	233-256
REC66T-11432-00	66T-11432-00	233-256
REC66T-11442-00	66T-11442-00	233-256
REC66T-11603-00	66T-11603-00	233-263-266
REC66T-11604-00	66T-11604-00	233-263
REC66T-11605-00	66T-11605-00	233-263
REC66T-11631-01-93	66T-11631-01-93	233-263-266
REC66T-11635-01	66T-11635-01	233-263
REC66T-11636-01K	66T-11636-01	233-263
REC66T-11681-01	66T-11681-01	233-260-261
REC66T-14301-60	66T-14301-60	92-93
REC66T-14384-01	66T-14384-01	94
REC66T-14536-01	66T-14536-01	94
REC66T-14992-00	66T-14992-00	99
REC66T-15713-00	66T-15713-00	112

REF	R.O. / OEM	
REC676-43160-02	676-43160-02	132
REC676-44311-00	676-44311-00	148-156-363-367
REC676-44315-00	676-44315-A0	367
REC676-44315-A1	676-44315-A1	156-363
REC676-44316-A1	676-44316-A1	363
REC676-44322-00	676-44322-00	156-367
REC676-44323-00-40	676-44323-00	149-156-367-363
REC676-44324-A0	676-44324-A0	367
REC676-44324-A0	676-44324-A1	363
REC676-44341-00	676-44341-94	363
REC676-44361-00	676-44361-00	367
REC676-44361-10	676-44361-10	367
REC676-44518-00	676-44518-00	135
REC676-45114-A1	676-45114-A1	271
REC676-45127-00	676-45127-00	269
REC676-45128-00	676-45128-00	269
REC676-45314-00	676-45314-00	363
REC676-45361-00	676-45361-01-94	363-390
REC676-45501-10	676-45501-10	363-389-390
REC676-45533-00	676-45533-00	363
REC676-45587-00	676-45587-00-70	363
REC676-45587-00-75	676-45587-00-75	363
REC676-45587-00-80	676-45587-00-80	363
REC676-45635-00	676-45635-00	359-363-365
REC677-11181-A0	677-11181-A1	225-248-254
REC677-11412-02	677-11412-02	225-256
REC677-11422-02	677-11422-02	225-256
REC677-11432-02	677-11432-02	225-256
REC677-11442-02	677-11442-02	225-256
REC677-11631-00K	677-11631-00-97	225-262-266
REC677-11635-00K	677-11635-00	225-262
REC677-11636-00K	677-11636-00	225-262
REC677-11651-00	677-11650-01	260
REC677-13621-00	677-13621-A1	273
REC677-14198-A1	677-14198-A1	273
REC677-14227-00	677-14227-01	94
REC677-14343-68	677-14343-68	98
REC677-14384-01	677-14384-01	94
REC677-24434-02	677-24434-02	273
REC677-24435-01	677-24435-01	87
REC677-24471-01	677-24471-01	87
REC677-26301-02	677-26301-02	129
REC677-41112-A0	677-41112-A1	225
REC677-41112-A0	677-41114-A0	140
REC677-41112-A0	677-41114-A1	225-389
REC677-45113-A0	677-45113-A0	225-252-254
REC677-W0093-00	677-W0093-00	95-225
REC679-14923-00	679-14923-00	99
REC679-44150-00	679-44150-00	367
REC679-44150-10	679-44150-10	367
REC679-44152-00	679-44152-00	367
REC679-44316-A0	679-44316-A0	367
REC679-44341-00	679-44341-00-94	367
REC679-44514-00-94	679-44514-00-94	135
REC679-45315-A1	679-45315-A1	365
REC679-45321-02	679-45321-02	365
REC679-45331-00	679-45331-00-94	365
REC679-45501-10	679-45501-10	367-389
REC679-45536-00	679-45536-00	367
REC679-45560-00	679-45560-00	365-389
REC679-45571-00	679-45571-00	365
REC679-45611-00	679-45611-01	359-365-389-390
REC679-W0078-A1	679-W0078-00	151-156
REC67C-11181-01	67C-11181-01	197-215-218
REC67C-11351-00	67C-11351-01	197-207-218
REC67C-11356-00	67C-11356-00	197
REC67C-11603-00	67C-11603-00	193-195-199-201-203-205-219
REC67C-15312-00	67C-15312-00	271
REC67C-41114-00	67C-41114-00	141
REC67C-41114-00	67C-41114-10	197
REC67C-41133-00	67C-41133-00	268
REC67C-43880-01	67C-43880-01	122
REC67C-43880-01	67C-43880-01	122
REC67C-45113-00	67C-45113-00	271
REC67C-45123-00	67C-45123-00	268
REC67C-45501-00	67C-45501-00	301-305-389-390
REC67C-45501-10	67C-45501-10	301-305-389-390
REC67C-W0001-01	67C-W0001-00	217
REC67C-W0001-01	67C-W0001-01	197-217-218
REC67C-W0001-20	67C-W0001-20	298
REC67D-W0093-00	67D-W0093-00	95-177
REC67F-11181-03	67F-11181-02	209
REC67F-11181-03	67F-11181-03	215-218
REC67F-11328-00	67F-11328-00	209-211-214
REC67F-11416-00	67F-11416-00	209
REC67F-11416-10	67F-11416-10	209
REC67F-11416-20	67F-11416-20	209
REC67F-12411-01	67F-12411-00	137
REC67F-12411-01	67F-12411-01	69-70-71-72-73-137-209-211-213
REC67F-14371-01	67F-14371-01	101
REC67F-41114-A2	67F-41114-A0	209
REC67F-41134-A0	67F-41134-A0	269
REC67F-41138-00	67F-41138-00	269
REC67F-44311-01	67F-44311-00	321
REC67F-44311-01	67F-44311-01-00	148-154-155
REC67F-44322-00	67F-44322-00	321-154-155

REF	R.O. / OEM	
REC67F-44323-00	67F-44323-00	149-154-155-321
REC67F-44352-00	67F-44352-00	143-321-154-155
REC67F-45113-00	67F-45113-00	272
REC67F-45123-00	67F-45123-00	269
REC67F-45127-00	67F-45127-00	269
REC67F-45331-00-CA	67F-45331-00-94	319
REC67F-45501-10	67F-45501-10	321-391
REC67F-45560-00	67F-45560-00	319-390-391
REC67F-45570-00	67F-45570-00	391
REC67F-45576-00	67F-45576-00	315-319
REC67F-45611-01	67F-45611-01	315-319-391
REC67F-45997-00	67F-45997-00	315-319-371-405
REC67F-46241-00	67F-46241-00	209-267
REC67F-81960-12	67F-81960-00	116
REC67F-85570-00	67F-85570-00	105
REC67F-W0001-00	67F-W0001-00	217
REC67F-W0001-01	67F-W0001-01	209
REC67F-W0001-01	67F-W0001-01	218
REC67F-W0001-20	67F-W0001-20	145-318
REC67F-W0078-00	67F-W0078-00	69-70-152-154-155-318
REC67F-W0093-00	67F-W0093-00	97-209
REC67H-11411-00	67H-11411-00	256
REC67H-13907-00	67H-13907-00	86
REC67H-8592A-01	67H-8592A-01	103
REC682-11351-A0	682-11351-A0	253
REC682-11412-00	682-11412-00	256
REC682-11422-00	682-11422-00	256
REC682-11432-00	682-11432-00	256
REC682-11442-00	682-11442-00	256
REC682-11610-01	682-11610-00	262
REC682-11610-01	682-11610-01	227-266
REC682-11610-11	682-11610-11	227-262
REC682-11610-21	682-11610-21	227-262
REC682-11681-00	682-11681-00	227-260
REC682-12413-00-1S	682-12413-00-1S	139-227
REC682-12413-00-1S	682-12413-00-9M	139
REC682-12414-A1	682-12414-A1	138-139-227
REC682-13621-A0	682-13621-A0	273
REC682-41112-00	682-41112-A1	140
REC682-41114-00	682-41114-A1	140
REC682-41133-A0	682-41133-A0	268
REC682-41237-00	682-41237-00	132
REC682-41237-50	682-41237-50	132
REC682-44147-00	682-44147-00	349-357
REC682-44176-00	682-44176-00	349
REC682-44312-00	682-44312-00	349
REC682-44315-00	682-44315-00	154-155-156-349
REC682-44322-00	682-44322-00	154-155-156-349
REC682-44323-00	682-44323-00	154-155-156-349
REC682-44328-00	682-44328-00	349
REC682-44352-01	682-44352-00	349
REC682-44352-01	682-44352-03	143-154-155-156
REC682-44361-01	682-44361-01	349
REC682-44361-10	682-44361-10	349
REC682-44365-00	682-44365-00	154-155-156-349
REC682-44514-01-94	682-44514-01-94	135
REC682-45113-A0	682-45113-02	254-271
REC682-45376-01	682-45376-01	349
REC682-45631-00	682-45631-00	291-293-349-351-387-388
REC682-W0078-A1	682-W0078-A1	150-154-155-156-348
REC683-44362-01	683-44361-01	349
REC683-44365-01	683-44365-01	349
REC683-44373-00	683-44373-00	349
REC683-45315-A0	683-45315-00	349
REC683-45361-01-4D	683-45361-01-EJ	349
REC683-45361-01-4D	683-45361-02-4D	291-351
REC683-45361-01-4D	683-45361-02-8D	293
REC683-45361-02-4D	683-45361-02-8D	387-388
REC683-45611-00	683-45611-00	291-293-349-351-387-388
REC683-W0001-21	683-W0001-21	348
REC683-W0001-21	683-W0001-C1	144
REC688-11111-02-1S	688-11111-02-1S	243
REC688-11181-A1	688-11181-A1	243
REC688-11181-A1	688-11181-A2	249-254
REC688-11193-A1	688-11193-A1	243-255
REC688-11370-00	688-11370-01	237-241-243
REC688-11411-00	688-11411-01	243-256
REC688-11603-A0	688-11603-A0	239-243-264-266
REC688-11605-A0	688-11605-A0	239-243-264
REC688-11610-02	688-11610-02	264-266
REC688-11631-02K	688-11631-02-95	264-266
REC688-11631-03K	688-11631-03-94	239-243-264
REC688-11631-81K	688-11631-81-96	264-266
REC688-11634-00	688-11634-00	229-239-243-263-264
REC688-11634-00	688-11634-10	241
REC688-11635-03K	688-11635-03	239-264
REC688-11636-03K	688-11636-03	264
REC688-11636-03K	688-11636-03	239
REC688-11650-03	688-11650-03	239-243-264
REC688-11651-00	688-11651-00	261
REC688-12413-00-1S	688-12413-00-1S	139-243
REC688-12414-A1	688-12414-A1	138-139-243-245-247

REF	R.O. / OEM	
REC688-12416-00	688-12416-00	139-243
REC688-13610-00	688-13610-00	99
REC688-13621-A1	688-13621-A1	274
REC688-14198-A1	688-14198-A2	274
REC688-14416-01	688-14416-01	274
REC688-14483-A0	688-14483-A0	274
REC688-14548-00	688-14548-00	99
REC688-14947-00	688-14947-00	98
REC688-41112-A0	688-41112-A0	142-243
REC688-41114-A0	688-41114-A0	142-243
REC688-41134-00	688-41134-A0	269
REC688-41211-01	688-41211-00	132
REC688-41211-01	688-41211-01	132
REC688-41217-00	688-41217-00	101
REC688-43160-01	688-43160-01	132
REC688-44120-12	688-44120-11	134
REC688-44120-12	688-44120-12	134
REC688-44120-22	688-44120-22	134
REC688-44311-01	688-44311-01	148-371
REC688-44311-01	688-44311-01	156
REC688-44311-01	688-44311-01-00	373
REC688-44315-00	688-44315-A0	321-371
REC688-44315-00	688-44315-A0-00	154-155-156
REC688-44316-00	688-44316-00	373
REC688-44316-00	688-44316-A0	371
REC688-44316-00	688-44316-A0-00	373
REC688-44322-00	688-44322-00	156-371
REC688-44322-00	688-44322-00-00	373
REC688-44323-00	688-44323-00-00	149-373
REC688-44323-00	688-44323-00	156-371
REC688-44324-00	688-44324-A0	321-371
REC688-44324-00	688-44324-A0-00	373
REC688-44341-01	688-44341-01-94	371
REC688-44341-01	688-44341-01	321
REC688-44341-01	688-44341-01-94	373
REC688-44352-03	688-44352-03	143-156-371
REC688-44352-03	688-44352-03-00	373
REC688-44361-10	688-44361-10	371
REC688-44514-00	688-44514-00	135
REC688-44555-00	688-44555-00	135
REC688-45113-A0	688-45113-A0	243-253-254
REC688-45114-A1	688-45114-A1	272
REC688-45123-00	688-45123-00	269
REC688-45214-02	688-45214-02	323-365
REC688-45215-02	688-45215-02	323-365
REC688-45331-00-94	688-45331-00-94	371-373-388-390-391
REC688-45341-00	688-45341-00	295-359-375
REC688-45341-00	688-45341-00-00	373
REC688-45341-00	688-45341-10	299-303-307-311-315-319-323-327-331-3

REF	R.O. / OEM	
REC689-11610-00	689-11610-01	263-266
REC689-11631-00K	689-11631-00-95	263-266
REC689-11633-00	689-11633-00	229-260-263
REC689-11651-00	689-11651-00	229-260-261
REC689-11681-00	689-11681-01	229-260-261
REC689-15396-01-CA	689-15396-01-5B	229
REC689-15755-00	689-15755-00	134
REC689-41112-A0	689-41112-A0	141
REC689-41114-A0	689-41114-A0	141
REC689-44311-00	689-44311-03	147-155-353
REC689-44315-A0	689-44315-A0	353
REC689-44316-A0	689-44316-A0	353
REC689-44323-00	689-44323-03	155-353
REC689-44324-A0	689-44324-A0	155-353
REC689-44352-02	689-44352-02	143-155-353
REC689-44366-00	689-44366-00	155-353-355
REC689-45501-00	689-45501-10	353-388-389
REC689-45551-00	689-45551-00	353-388-389
REC689-45560-00	689-45560-00	353-388-389
REC689-45571-00-00	689-45570-00	353-388-389
REC689-45611-00	689-45611-00	353-388-389
REC689-45997-00	689-45997-00	295-353-355-357-405
REC689-81311-40	66M-85570-00	105
REC689-85540-21	689-85540-20	119
REC689-85540-21	689-85540-21	119
REC689-W0001-20	689-W0001-20	145
REC689-W0001-21	689-W0001-21	145-353
REC689-W0001-C2	689-W0001-C2	145
REC689-W0078-04	689-W0078-04	151-155
REC689-W0078-A6	689-W0078-A6	151-155-353
REC689-W0093-02	689-W0093-02	95
REC689-W4432-01	689-W4432-02	155-156-353
REC68D-E1603-00	68D-E1603-00	175-219
REC68F-11181-00	68F-11181-00	249-254
REC68F-11193-02	68F-11193-02	255
REC68F-11381-00	68F-11381-00	276
REC68F-13440-00	68F-13440-00	83
REC68F-13907-01	68F-13907-01	86
REC68F-13915-00	68F-13915-00	82
REC68F-24563-00	68F-24563-00	81
REC68F-24563-10	68F-24563-10	81
REC68F-41114-00	68F-41114-00	142
REC68F-45113-01	68F-45113-01	253-254
REC68F-8195A-00	68F-8195A-00	115
REC68F-83688-00	68F-83688-00	90-102
REC68F-83688-10	68F-83688-10	90-102
REC68F-8592A-00	68F-8592A-00	103
REC68F-W0001-01	68F-W0001-01	252-254
REC68T-13475-00	68T-13475-00	271
REC68T-24251-00	68T-24251-00	80-82
REC68T-24251-00	68T-24251-01	80
REC68T-24251-00	6EE-F4251-00	80
REC68T-24251-00	68T-24251-00	64-65-81
REC68T-24410-00-00	68T-24410-00	85
REC68T-24410-00-00	68T-24410-01	85
REC68T-44323-00	68T-44323-00	149-154-289-293
REC68T-44352-00	68T-44352-00	143-154-289
REC68T-44366-00	68T-44366-00	154-289
REC68T-45551-A0	6N0-G5551-A0	289
REC68T-46241-00	60R-G6241-00	180
REC68T-46241-00	68T-46241-00	267
REC68T-85540-00	68T-85540-00	118
REC68T-W0001-20	68T-W0001-20	144-289
REC68T-W0078-00	68T-W0078-00	150-289
REC68T-W0078-00	68T-W0078-01	64-65-150-154
REC68V-11351-00	68V-11351-00	209-218
REC68V-12111-00	68V-12111-00	209
REC68V-13761-10	68V-13761-10	90
REC68V-13907-00	68V-13907-00	86
REC68V-13907-00	68V-13907-01	86
REC68V-13907-00	68V-13907-02	86
REC68V-13907-00	68V-13907-03	86
REC68V-13907-00	68V-13907-04	86
REC68V-13915-00	68V-13915-00	72-82
REC68V-14984-00	68V-14984-00	72-86-88
REC68V-15312-00	68V-15312-00	272
REC68V-24410-00	68V-24410-00	85
REC68V-24563-00	68V-24563-00	68-80-81-82
REC68V-44323-00	6EK-44323-00	149-155-269-325
REC68V-45123-00	68V-45123-00	269
REC68V-45501-10	68V-45501-10	325
REC68V-81950-00	68V-81950-00	115
REC68V-82380-00	68V-82380-00	90-102
REC68V-85885-00	68V-85885-00	90-102
REC68V-8A360-00	68V-13761-00	89
REC68V-8A360-00	68V-8A360-00	89-90
REC68V-W0001-20	68V-W0001-20	147-322
REC68V-W0078-00	68V-W0078-00	70-71-152-155-322
REC692-14590-01	692-14590-00	98
REC692-14590-01	692-14590-01	98
REC692-14923-00	692-14923-00	98
REC692-24410-00	692-24410-00	85
REC692-24410-00	6A0-24410-00	85
REC692-24410-00	6A0-24410-03	85
REC692-24410-00	6A0-24410-04	85
REC692-24410-00	6A0-24410-05	85
REC692-24411-00	692-24411-00	87
REC692-26301-03	692-26301-00	129
REC692-26301-03	692-26301-01	129
REC692-26301-03	692-26301-02	129
REC692-26301-03	692-26301-03	129

REF	R.O. / OEM	
REC692-41256-00	692-41256-00	101
REC692-44120-22	692-44120-21	134
REC692-44120-22	692-44120-22	134
REC692-45300-16-8D	692-45300-12-4D	280
REC692-45300-16-8D	692-45300-13-4D	280
REC692-45300-16-8D	692-45300-14-4D	280-370
REC692-W0078-02	692-W0078-00-00	373
REC692-W0078-02	692-W0078-01-00	373
REC692-W0078-02	692-W0078-00	152
REC692-W0078-02	692-W0078-01	152
REC692-W0078-02	692-W0078-02	152-156-370
REC695-11181-00	695-11181-A1	248-254
REC695-85540-11	695-85540-11	119
REC695-85540-11	695-85540-12	119
REC695-W0001-A2	695-W0001-01	250-254
REC696-14590-01	696-14590-01	98
REC696-45113-00	696-45113-00	239
REC696-45113-00	696-45113-A0	253-254
REC696-85540-12	696-85540-10	119
REC696-85540-12	696-85540-11	119
REC696-85540-12	696-85540-12	119
REC696-W0093-00	696-W0093-00	239
REC696-W0093-00	696-W0093-02	96
REC697-11181-A1	697-11181-A2	239-249-254
REC697-45114-00	697-45114-A0	254-271
REC697-45384-00	697-45384-00	359-365-369
REC697-45551-00	697-45551-00	369-390
REC697-45560-00	697-45560-00	369-390
REC697-45570-00	697-45571-00	369
REC697-45571-00-00	697-45571-00	390
REC697-45611-00	697-45611-00	369-388-390
REC697-85570-00	697-85570-00	105
REC697-85570-10	697-85570-10	105
REC697-W0001-02	697-W0001-01	239
REC697-W0001-02	697-W0001-A0	251
REC697-W0001-02	697-W0001-A0	254
REC698-W0001-21	698-W0001-21	145-368
REC69D-45501-10	69D-45501-10	390
REC69D-W0001-20	69D-W0001-20	146
REC69G-45510-10	69G-45510-10	387
REC69G-45510-20	69G-45510-20	387
REC69G-W0001-20	69G-W0001-20	144-289
REC69G-W0078-01	69G-W0078-01	150
REC69G-W0078-01	69G-W0078-01	150
REC69J-11181-03	69J-11181-03	216-218
REC69J-11182-03	69J-11182-03	216-218
REC69J-11351-11	69J-11351-11	213-218
REC69J-12111-00	69J-12111-00	211
REC69J-12119-00	69J-12119-00	211
REC69J-13645-00	69J-13645-A1	273
REC69J-13761-00	69J-13761-00	90
REC69J-13906-00	69J-13906-00	89-90
REC69J-13907-03	69J-13907-00	86
REC69J-13907-03	69J-13907-01	86
REC69J-13907-03	69J-13907-02	86
REC69J-13907-03	69J-13907-03	86
REC69J-13907-03	69J-13907-04	86
REC69J-15451-00	69J-15451-00	213
REC69J-15451-00	69J-15451-A1	273
REC69J-24410-02	69J-24410-00	86
REC69J-24410-02	69J-24410-01	86
REC69J-24501-10	69J-24501-10	71-72-81
REC69J-24502-00	69J-24502-00	81
REC69J-41134-A0	69J-41134-A0	270
REC69J-41135-A0	69J-41135-A0	270
REC69J-41138-00	69J-41138-00	270
REC69J-45123-00	69J-45123-00	270
REC69J-45361-00-8D	69J-45361-00-8D	331-383
REC69J-45375-00	69J-45375-00	331-383
REC69J-45611-00	69J-45611-00	331-337-392
REC69J-45631-00	69J-45631-00	331-337-392
REC69J-46241-00	69J-46241-00	267
REC69J-81960-13	69J-81960-10	116
REC69J-81960-13	69J-81960-11	116
REC69J-81960-13	69J-81960-12	116
REC69J-81960-13	69J-81960-13	116
REC69J-85885-00	69J-85885-00	90-102
REC69J-W0001-20-00	69J-W0001-20	147
REC69K-45611-00	69K-45611-00	331-337
REC69L-11635-00-85	69L-11635-00-85	267
REC69L-11642-00	69L-11642-00-85	267
REC69M-E1603-01	69M-E1603-01	173-219
REC69P-85541-09	69P-85541-09	106
REC69W-82575-00	69W-82575-00	120
REC6A0-14325-00	6A0-14325-00	99
REC6A0-24410-04	6A0-24410-00	85
REC6A0-24410-04	6A0-24410-01	85
REC6A0-24410-04	6A0-24410-02	85
REC6A0-24410-04	6A0-24410-03	85
REC6A0-24410-04	6A0-24410-04	85
REC6A0-82550-01	6A0-82550-01	120
REC6A0-W0001-21	6A0-W0001-21	146
REC6A1-14301-03	6A1-14301-03	92-93
REC6A1-14613-A0	6A1-14613-00	270
REC6A1-14613-A0	6A1-14613-01	270
REC6A1-14613-A0	6A1-14613-A0	220-270
REC6A1-44325-00P	6A1-44325-00P	343
REC6A1-44361-00	6A1-44361-00	343
REC6A1-85540-00	6A1-85540-00	118
REC6A1-85540-01	6A1-85540-01	118
REC6A1-85570-00	6A1-85570-00	105
REC6A1-85570-00	6A1-85570-00	144
REC6A1-W0001-22	6A1-W0001-22	144
REC6A1-W0001-23	6A1-W0001-23	144-343

REF	R.O. / OEM	
REC6A1-W0078-01	6A1-W0078-01	150-155-343
REC6A1-W0093-01	6A1-W0093-01	93-95
REC6AG-11181-00	6AG-11181-00	215
REC6AG-11181-00	6AG-11181-10	187-218
REC6AH-11351-00	6AH-11351-10	187-218
REC6AH-12411-00	69M-12411-00	136
REC6AH-12411-00	69M-12411-01	136-173-175
REC6AH-12411-00	6G8-12411-00	136-187
REC6AH-12411-00	6G8-12411-01	181
REC6AH-12411-00	6AH-12411-00	65-137
REC6AH-13329-00	6AH-13329-00	271
REC6AH-15312-00	6AH-15312-00	271
REC6AH-W0078-00	6AH-W0078-00	150-153-292
REC6AH-W0078-00	6AH-W0078-01	150-292
REC6AH-W0078-00	6AH-W0078-01	65-154
REC6AW-11181-00	6AW-11181-00	214-216-218
REC6AW-11182-00	6AW-11182-00	214-216-218
REC6AW-11351-00	6AW-11351-00	214-218
REC6AW-12411-00	6AW-12411-00	73-137-214
REC6AW-13907-00	6AW-13907-00	86
REC6AW-13907-00	6P2-13907-00	86
REC6AW-14613-00	6AW-14613-00	272
REC6AW-14623-00	6AW-14623-00	272
REC6AW-14984-00	65L-13907-00	86
REC6AW-14984-00	66K-13907-00	86
REC6AW-14984-00	67H-13907-00	86
REC6AW-14984-00	6AW-14984-00	73-88
REC6AW-15312-00	6AW-15312-00	272
REC6AW-15451-00	6AW-15451-00	214-272
REC6AW-41134-01	6AW-41134-00	270
REC6AW-43880-02	6AW-43880-00	123
REC6AW-43880-02	6AW-43880-01	123
REC6AW-43880-02	6AW-43880-02	123
REC6AW-44311-01	6AW-44311-00	148-341
REC6AW-44311-01	6AW-44311-01	148
REC6AW-44312-00	6AW-44312-00	335-341
REC6AW-44315-00	6AW-44315-00	341
REC6AW-44322-00	6AW-44322-00	335-341
REC6AW-44323-00	6AW-44323-00	341
REC6AW-44336-00	6AW-44336-00	341



REF	R.O. / OEM	
REC6D8-WS24A-00	6D8-24563-00	80
REC6D8-WS24A-00	6D8-WS24A-00	66-67-68-69-70-71-80-81
REC6D9-12411-00	6D9-12411-00	70-137
REC6D9-45551-00	6D9-45551-00	319
REC6DA-11181-00	6DA-11181-00	216-218
REC6DA-12411-01	6DA-12411-01	72-136-137
REC6DA-13761-00	6DA-13761-00	90
REC6E0-11193-A1	6E0-11193-A1	221
REC6E0-11631-00-98K	6E0-11631-00-98	221-262-266
REC6E0-11651-01	6E0-11651-01	221-225-260
REC6E0-24411-00	6E0-24411-00	87
REC6E0-24434-00	6G1-24431-01	87
REC6E0-24435-00	6E0-24435-00	87
REC6E0-24471-00	6E0-24471-00	87
REC6E0-26301-01	6E0-26301-01	129
REC6E0-41112-A1	6E0-41112-A1	140-21
REC6E0-41114-A1	6E0-41114-A1	140-221
REC6E0-43118-01	6E0-43118-00	134
REC6E0-43118-01	6E0-43118-01	134
REC6E0-44322-02	6E0-44322-02	154-155-345
REC6E0-44352-00	6E0-44352-00	143-154-155-287-345
REC6E0-45113-A1	6E0-45113-A1	221-252
REC6E0-45316-00	6E0-45316-09	345
REC6E0-45317-00	6E0-45317-09	345
REC6E0-45511-01	6E0-45511-01	345-387
REC6E0-45511-11	6E0-45511-11	345-387
REC6E0-45551-00	6E0-45551-00	345-387
REC6E0-45560-00	6E0-45560-00	345-387
REC6E0-45570-00	6E0-45570-00	345-387
REC6E0-45611-01	6E0-45611-01	345
REC6E0-45631-00	6E0-45631-00	345-387
REC6E0-85540-71	6E0-85540-70	119
REC6E0-85540-71	6E0-85540-71	119
REC6E0-85570-00	6E0-85570-00	104
REC6E0-W0001-C1	6E0-W0001-C1	144-285-345
REC6E0-W0078-A2	6E0-W0078-00	150-153
REC6E0-W0078-A2	6E0-W0078-01	150-153
REC6E0-W0078-A2	6E0-W0078-02	150-153
REC6E0-W0078-A2	6E0-W0078-A2	150-153-155-285-345
REC6E3-14301-05	6E3-14301-05	92-93
REC6E5-11181-A0	6E5-11181-A2	245-249-254
REC6E5-11193-A0	6E5-11193-A0	245-255
REC6E5-11381-A1	6E5-11381-A1	275
REC6E5-11381-A1	6E5-11381-A2	245-247
REC6E5-11411-00	6E5-11411-00	256
REC6E5-11447-00	6E5-11447-00	245-247
REC6E5-11610-02	6E5-11610-02	265-266-267
REC6E5-11633-00	6E5-11633-01	261-265
REC6E5-11634-00	6E5-11634-00	265
REC6E5-11650-01	6E5-11650-01	261
REC6E5-11651-00	6E5-11651-00	261
REC6E5-12411-02	6E5-12411-00	136
REC6E5-12411-02	6E5-12411-01	136-221-223-229-231-233
REC6E5-12411-02	6E5-12411-02	136-137
REC6E5-12411-30	6E5-12411-10	243
REC6E5-12411-30	6E5-12411-10	137
REC6E5-12411-30	6E5-12411-20	137
REC6E5-12411-30	6E5-12411-30	137-227-237-245-247
REC6E5-12411-30	6E5-12411-30	137
REC6E5-13411-00	6E5-13411-00	83
REC6E5-13621-A1	6E5-13621-A1	275
REC6E5-13645-A1-00	6E5-13645-A1	275
REC6E5-14198-A2	6E5-14198-A2	275
REC6E5-14323-03	6E5-14323-03	99
REC6E5-14328-01	6E5-14328-01	99
REC6E5-14385-02	6E5-14385-02	93-100
REC6E5-14386-01	6E5-14386-01	99
REC6E5-14386-02	6E5-14386-02	99
REC6E5-14416-A1	6E5-14416-A1	275
REC6E5-14483-A1	6E5-14483-A1	275
REC6E5-14546-00	6E5-14546-00	93-98
REC6E5-24351-51	6E5-24351-51	75
REC6E5-24351-51	6E5-24351-51	75
REC6E5-24410-03	6E5-24410-01-00	85
REC6E5-24411-00	6E5-24411-00-00	87
REC6E5-24434-02	6E5-24434-02	88
REC6E5-24435-00	6E5-24435-00	88
REC6E5-24471-00	6E5-24471-00	87
REC6E5-41112-A1	6E5-41112-A1	142-245
REC6E5-41134-A0	6E5-41134-A0	269-270
REC6E5-44150-02	6E5-44150-01	377
REC6E5-44311-00	6E5-44311-00	155-156-157-381
REC6E5-44312-00	6E5-44312-00	325-329-333-339-385-386
REC6E5-44315-A0	6E5-44315-A0	156-157-325-329-333-377-381-385
REC6E5-44322-00	6E5-44322-00	156-157-381
REC6E5-44323-00-40	6E5-44323-00	149-155-156-157-377
REC6E5-44352-01	6E5-44352-01	143-155-156-157-325-329-333-339-377-381-385-386
REC6E5-44365-00	6E5-44365-00	155-157-325-329-333-339-377-381-385-386

REF	R.O. / OEM	
REC6E5-44366-00	6E5-44366-00	155-156-157-325-333-339-377-381
REC6E5-45113-A2	6E5-45113-A0	253-254
REC6E5-45114-00	6E5-45114-A0	272
REC6E5-45321-00	6E5-45321-00	325-329-377-381
REC6E5-45331-00-94	6E5-45331-00-94	377-381
REC6E5-45331-00-94	6E5-45331-00-9S	325-329-391
REC6E5-45332-00-94	6E5-45332-00-94	375
REC6E5-45332-00-94	6E5-45332-00-CA	323
REC6E5-45344-00	6E5-45344-00	325-329-333-339-377-381-385
REC6E5-45371-01	6E5-45371-01	161-169-375
REC6E5-45501-01	6E5-45501-01	377-391
REC6E5-45536-00	6E5-45536-00	325-377
REC6E5-45536-00	6E5-45536-01	329
REC6E5-45551-02	6E5-45551-02	375-391
REC6E5-45560-01	6E5-45560-01	375-391
REC6E5-45567-01	6E5-45567-01	323
REC6E5-45567-01	6E5-45567-01-60	375
REC6E5-45570-00	6E5-45571-01	375-391
REC6E5-45576-00	6E5-45576-00	323-375
REC6E5-45587-01	6E5-45587-01	325-329-377
REC6E5-45611-00	6E5-45611-00	323
REC6E5-45611-01	6E5-45611-01	375-391-392
REC6E5-45631-00	6E5-45631-01	375-391-392
REC6E5-45633-01	6E5-45633-01	323-327-335-375-379-391-392
REC6E5-45634-01	6E5-45634-01	323-327-375
REC6E5-45634-01	6E5-45634-02	327
REC6E5-45641-03	6E5-45641-02	375
REC6E5-45641-03	6E5-45641-03	327-379
REC6E5-45987-00	63P-45987-00	323-327
REC6E5-45987-00	6E5-45987-01	379
REC6E5-45987-00	6E5-45987-01	375
REC6E5-45987-00	6E5-45987-01	405
REC6E5-81900-01	6E5-81900-01	84
REC6E5-85510-11	6E5-85510-10	121
REC6E5-85510-11	6E5-85510-11	121
REC6E5-85540-12	6E5-85540-10	119
REC6E5-85540-12	6E5-85540-11	119
REC6E5-85540-12	6E5-85540-12	119
REC6E5-85570-10	6E5-85570-10	105
REC6E5-85570-11	6E5-85570-11	105
REC6E5-W0001-A2	6E5-W0001-A2	251
REC6E5-W0001-A2	6N6-W0001-A3	245
REC6E5-W0001-A2	6E5-W0001-A2	254
REC6E5-W0001-F1	6E5-W0001-F1	147-374-378
REC6E5-W0001-F1	6F3-W0001-21	147
REC6E5-W0093-06	6E5-W0093-06	97-245
REC6E5-W0093-07	6E5-W0093-07	97
REC6E5-W0093-08	6E5-W0093-08	97
REC6E7-11111-01-1S	6E7-11111-01-1S	227
REC6E7-11181-00	6E7-11181-A2	248-254
REC6E7-11631-00K	6E7-11631-00	262
REC6E7-11631-00K	6E7-11631-00-97	227
REC6E7-11631-00K	6E7-11631-00-97	266
REC6E7-11635-00K	6E7-11635-00	227-262
REC6E7-11636-00K	6E7-11636-00	227-262
REC6E7-14227-00	6E7-14227-00	94
REC6E7-14385-00	6E7-14385-00	93-100
REC6E7-44366-00	6E7-44366-00	349
REC6E7-45331-00-CA	6E7-45331-00-9M	349
REC6E7-45501-00	6E7-45501-00	349
REC6E7-45501-11	6E7-45501-10	349-387-388
REC6E7-45536-00	6E7-45536-00	349
REC6E7-45551-00	6E7-45551-00	348-387-388
REC6E7-45560-01	6E7-45560-00	349
REC6E7-45560-01	6E7-45560-01	291-293-351-387-388
REC6E7-45570-00	6E7-45570-00	293
REC6E7-45570-00	6E7-45571-00	291-349-351-387-388
REC6E7-45987-00	6E7-45987-00	291-349
REC6E7-45987-00	6E7-45987-01	293-351-405
REC6E7-85570-19	6E7-85570-19-00	106
REC6E7-W0001-A1	6E7-W0001-00	249
REC6E7-W0001-A1	6E7-W0001-A1	249-254
REC6E7-W0093-01	6E7-W0093-04	95
REC6E8-14390-12	6E8-14390-12	98
REC6E9-11193-A0	6E9-11193-A0	255
REC6E9-12413-00-1S	6E9-12413-00-1S	139-235
REC6E9-12414-A1	6E9-12414-A1	138-139-235
REC6E9-14198-A0	6E9-14198-A0	275
REC6E9-41114-A0	6E9-41114-A0	142
REC6E9-82575-02	6E9-82575-00	120
REC6E9-W0093-02	6E9-W0093-02	96
REC6E9-W0093-03	6E9-W0093-03	96
REC6EE-W0078-00	6BX-WG0078-00	150
REC6EE-W0078-01	6EE-W0078-00	150
REC6EE-W0078-01	6EE-W0078-01	150
REC6EK-13761-00	6EK-13761-00	90
REC6F3-W0001-04-00	6F3-W0001-A4	251
REC6F5-11181-A2	6F5-11181-A1	235
REC6F5-11181-A2	6F5-11181-A2	248-254
REC6F5-11515-00	6F5-11515-00	233-235
REC6F5-11610-00	6F5-11610-00	263
REC6F5-11610-00	6F6-11610-00	235
REC6F5-11610-10	6F5-11610-10	263
REC6F5-11610-10	6F6-11610-10	235
REC6F5-11610-20	6F5-11610-20	263
REC6F5-11610-20	6F6-11610-20	235

REF	R.O. / OEM	
REC6F5-11633-00	6F5-11633-00	233-235-260-261-263
REC6F5-11651-00	6F5-11651-00	233-235-260-261
REC6F5-11681-00	6F5-11681-00	235-261
REC6F5-12411-03	6F5-12411-00	137
REC6F5-12411-03	6F5-12411-01	137
REC6F5-12411-03	6F5-12411-02	137-235-239
REC6F5-12411-03	6F5-12411-03	137
REC6F5-12411-03	6F5-12411-03	137
REC6F5-13621-A1	6F5-13621-A1	275
REC6F5-13645-A0	6F5-13645-A0	274
REC6F5-13646-A2	6F5-13646-A1	274
REC6F5-14198-A1	6F5-14198-A1	275
REC6F5-14323-00	6F5-14323-01	98
REC6F5-14384-00	6F5-14384-00	94
REC6F5-14390-21	6F5-14390-21	98
REC6F5-14398-00	6F5-14398-00	94
REC6F5-14483-00	6F5-14483-00	94
REC6F5-15396-01-5B	6F5-15396-01-5B	235
REC6F5-24563-00	6F5-24563-00	80-81-82
REC6F5-26311-00	6F5-26311-00	129
REC6F5-41111-01-1S	6F5-41111-01-1S	235
REC6F5-41112-A0	6F5-41112-A0	141-235
REC6F5-41113-A0-1S	6F5-41113-01-1S	235
REC6F5-41114-A0	6F5-41114-A0	142-235
REC6F5-44352-00	6F5-44352-00	143-363
REC6F5-44352-00	6F5-44352-02	156-367
REC6F5-45113-A0	6F5-45113-A0	235-255-254
REC6F5-45312-00-4D	6F5-45312-01-4D	363
REC6F5-45551-00	6F5-45551-00	363-389-390
REC6F5-45560-00	6F5-45560-00	363-389-390
REC6F5-45570-00	6F5-45570-00	363-389-390
REC6F5-85540-22	6F5-85540-22	119
REC6F5-85570-11	F5-85570-13	105
REC6F5-W0001-C0	6F5-W0001-C0	145-363
REC6F5-W0078-A0	6F5-W0078-00	151
REC6F5-W0078-A0	6F5-W0078-A0	156-363
REC6F6-11111-00-1S	6F6-11111-00-1S	235
REC6F6-11191-00-1S	6F6-11191-00-1S	235
REC6F6-11193-A1	6F6-11193-A1	235-255
REC6F6-11400-02	6F6-11400-01	235
REC6F6-11631-00K	6F6-11631-00-95	235-263
REC6F6-11635-00K	6F6-11635-00	235-263
REC6F6-11636-00K	6F6-11636-00	235-263
REC6F6-13610-00	6F6-13610-00	99
REC6F6-14301-06	6F6-14301-06	91
REC6F6-14341-00	6F6-14341-00	98
REC6F6-14385-00	6F6-14385-00	100
REC6F6-45611-00	6F6-45611-00	363-389-390
REC6F6-85530-01	6F6-85530-01	106
REC6F6-85540-01	6F6-85540-01	118
REC6F6-W0001-02	6F6-W0001-02	234-251
REC6F6-W0093-00	6F6-W0093-00	96-234
REC6F8-11181-A1	6F8-11181-A1	220-248-254
REC6FM-12411-00	6FM-	

REF	R.O. / OEM	
REC6G1-81970-62	6G1-81970-60	116
REC6G1-81970-62	6G1-81970-61	116
REC6G1-81970-62	6G1-81970-62	116
REC6G1-81970-62	6G1-81970-A0	116
REC6G1-W0001-C1	6G1-W0001-C0	144
REC6G1-W0001-C1	6N0-W0001-20	346
REC6G1-W0078-A1	6G1-W0078-00	150
REC6G1-W0078-A1	6G1-W0078-01	150
REC6G1-W0078-A1	6G1-W0078-A1	150-346
REC6G1-W0078-A1	6N0-W0078-A0	150
REC6G1-W0078-A1	6G1-W0078-A1	155
REC6G1-W0093-00	6G1-W0093-00	93-95-223
REC6G5-11181-A2	6G5-11181-A3	247-249-254
REC6G5-11193-A0	6F5-11193-A0	247
REC6G5-11193-A0	6G5-11193-A1	255
REC6G5-11382-A1	6G5-11382-A1	142-245-247
REC6G5-11411-02	6G5-11411-02	247-256
REC6G5-11631-00K	6G5-11631-00-93	265-266-267
REC6G5-11642-00K	6G5-11642-00-93	265-266-267
REC6G5-13645-A1	6G5-13645-A2	276
REC6G5-14416-A1	6G5-14416-A1	275
REC6G5-14483-01	6G5-14483-A1	276
REC6G5-41112-A1	6G5-41112-A1	142-247
REC6G5-41114-A0	6G5-41114-A0	142-247
REC6G5-41134-A1	6G5-41134-A1	270
REC6G5-41217-00	6G5-41217-01	101
REC6G5-43864-A0	6G5-43864-00	125
REC6G5-44150-02	6G5-44150-02	381
REC6G5-44323-00	6G5-44323-00	329-333-381-385
REC6G5-44323-00	6G5-44323-01	149
REC6G5-44323-00	6G5-44323-00	155-157
REC6G5-45113-A1	6G5-45113-A1	245-247
REC6G5-45113-A1	6G5-45113-A2	253-254
REC6G5-45114-A0	6G5-45114-A1	272
REC6G5-45383-01	6G5-45383-01	327-379
REC6G5-45384-00	6G5-45384-00	327-379
REC6G5-45501-21	6G5-45501-21	381-391-392
REC6G5-45536-01	6G5-45536-01	381
REC6G5-45551-00	6G5-45551-01	379-391-392
REC6G5-45560-00	6G5-45560-01	379-391-392
REC6G5-45571-00	6G5-45571-02	379-391-392
REC6G5-45576-10	6G5-45576-10	327
REC6G5-45631-00	6G5-45631-00	379-391-392
REC6G5-81960-A0	6G5-81960-A0	116
REC6G5-85510-11	6G5-85510-10	121
REC6G5-85540-12	6G5-85540-10	119
REC6G5-85540-12	6G5-85540-11	119
REC6G5-85540-12	6G5-85540-12	119
REC6G5-W0001-A3	6G5-W0001-03	252
REC6G5-W0001-A3	6G5-W0001-A3-00	247
REC6G5-W0001-A3	6G5-W0001-03	254
REC6G5-W0078-A1	6G5-W0078-00	152
REC6G5-W0078-A1	6G5-W0078-01	152
REC6G5-W0078-A1	6G5-W0078-A1	152-157-378
REC6G8-11181-A1	6G8-11181-01	181
REC6G8-11181-A1	6G8-11181-A1	215-218
REC6G8-11351-A0	6G8-11351-00	181
REC6G8-11351-A0	6G8-11351-A0	217-218
REC6G8-12414-A0	60R-E2414-A0	180
REC6G8-12414-A0	6G8-12414-00	181
REC6G8-12414-A0	6G8-12414-A0	138
REC6G8-13440-00	6G8-13440-00	83
REC6G8-13645-00	6G8-13645-00	273
REC6G8-13646-A0	6G8-13646-00	273
REC6G8-14198-A0	6G8-14198-00	273
REC6G8-15374-00	6G8-15374-00	273
REC6G8-41112-02	6G8-41112-02	140-181
REC6G8-41114-00	6G8-41114-00	140
REC6G8-45113-A1	6G8-45113-A1	271
REC6G8-46241-00	6G8-46241-00	267
REC6G8-81870-00	6G8-81870-00	120
REC6G8-81960-A1	6G8-81960-A1	117
REC6G8-W0001-A3	6G8-W0001-A3	181-216-218
REC6G9-85540-29	6G9-85540-20	117-118
REC6G9-85540-29	6G9-85540-21	117-118
REC6G9-85540-29	6G9-85540-22	117-118
REC6G9-85540-29	6G9-85540-29	117-118
REC6G9-W0001-C4	6G9-W0001-C4	144
REC6G9-W0001-C6	6G9-W0001-C6	144
REC6H0-81960-00	6H0-81960-00	116
REC6H0-W0093-00	6H0-W0093-00	97
REC6H1-11631-03K	6H1-11631-03-95	264-266
REC6H1-15359-01-94	6H1-15359-01-94	243
REC6H1-43800-17-8D	6H1-43800-13-4D	124
REC6H1-43800-17-8D	6H1-43800-14-4D	124
REC6H1-43800-17-8D	6H1-43800-15-4D	124
REC6H1-43800-17-8D	6H1-43800-16-4D	124
REC6H1-43800-17-8D	6H1-43800-17-8D	124
REC6H1-44144-00	6H1-44144-00	373
REC6H1-45214-00	6H1-45214-00	315-319
REC6H1-45215-00	6H1-45215-00	315-319
REC6H1-45611-00	6H1-45611-01-00	373-390-391
REC6H1-45631-01	6H1-45631-01-00	373-390-391
REC6H1-45634-02	6H1-45634-02	373
REC6H1-45668-00	6H1-45668-00	315-319-331-335-337-341-373-383
REC6H1-81950-01	6H1-81950-00	115
REC6H1-81950-01	6H1-81950-01	115
REC6H1-85510-00	6H1-85510-00	121
REC6H1-W0001-00-00	6H1-W0001-A1	251
REC6H1-W0093-01-00	6H1-W0093-01	97
REC6H1-W0093-01-00	6H1-W0093-01-00	243
REC6H1-W0093-10	6H1-W0093-10	97

REF	R.O. / OEM	
REC6H2-81960-10	6H2-81960-10	116
REC6H2-85540-13	6H2-85540-10	118
REC6H2-85540-13	6H2-85540-11	118
REC6H2-85540-13	6H2-85540-12	118
REC6H2-85540-13	6H2-85540-13	118
REC6H2-W0001-20	6H2-W0001-20	146
REC6H2-W0093-10	6H2-W0093-10	96-241
REC6H3-11181-A2	6H3-11181-A2	241-248-254
REC6H3-11193-A1	6H3-11193-A1	241-255
REC6H3-11631-01K	6H3-11631-01-96	241-262-266
REC6H3-11633-00	6H3-11633-00	241-261-262-264
REC6H3-11635-01K	6H3-11635-01	241-262
REC6H3-11636-01K	6H3-11636-01	241-262
REC6H3-12411-10	6H3-12411-00	137
REC6H3-12411-10	6H3-12411-01	137
REC6H3-12411-10	6H3-12411-10	137-241
REC6H3-12411-10	6H3-12411-11	137
REC6H3-12414-A1	6H3-12414-A1	203-205-207
REC6H3-13621-A1	6H3-13621-A1	138-241
REC6H3-13622-A1	6H3-13622-A1	274
REC6H3-14198-A1	6H3-14198-A1	274
REC6H3-14457-01	6H3-14457-01	94
REC6H3-14590-00	6H3-14590-01	93-98
REC6H3-41112-A0	6H3-41112-A0	141-241
REC6H3-41114-A0	6H3-41114-A0	141-241
REC6H3-41217-00	6H3-41217-00	101
REC6H3-44311-00	6H3-44311-00	148
REC6H3-44315-00	6H3-44315-00	154-156
REC6H3-44323-00	6H3-44323-00-00	149-154-156
REC6H3-44352-00	6H3-44352-00	369
REC6H3-44352-00	6H3-44352-00	143-154-156-313-317
REC6H3-45113-00	6H3-45113-00	241
REC6H3-45113-A0	6H3-45113-A0	253-254
REC6H3-45114-A1	6H3-45114-A1	271
REC6H3-45123-00	6H3-45123-00	269
REC6H3-45127-00	6H3-45127-00	269
REC6H3-82510-03	6H3-82510-00	114
REC6H3-82510-03	6H3-82510-01	114
REC6H3-82510-03	6H3-82510-02	114
REC6H3-82510-03	6H3-82510-03	114
REC6H3-85520-00	6H3-85520-00	107
REC6H3-85540-11	6H3-85540-10	118
REC6H3-85540-11	6H3-85540-11	118
REC6H3-85540-12	6H3-85540-12	118
REC6H3-85540-13	6H3-85540-10	118
REC6H3-85540-13	6H3-85540-11	118
REC6H3-85540-13	6H3-85540-12	118
REC6H3-85540-13	6H3-85540-13	118
REC6H3-85570-10	6H3-85570-10	104
REC6H3-W0001-02	6H3-W0001-02	241-250-254
REC6H3-W0001-22	6H3-W0001-22	145
REC6H3-W0078-02	6H3-W0078-00	68-69-152-154-156
REC6H3-W0093-02	6H3-W0093-02	93-97
REC6H4-11181-00	6H4-11181-A2	248-254
REC6H4-11193-A1	6H4-11193-00	255
REC6H4-11610-00-00	6H4-11610-00	264-266
REC6H4-11631-00K	6H4-11631-00-96	264-266
REC6H4-11631-01K	6H4-11631-01-95	237-263-266
REC6H4-11634-01	6H4-11634-01	237-263-264
REC6H4-11635-00K	6H4-11635-00	264
REC6H4-11635-01K	6H4-11635-01	237-263
REC6H4-11636-01K	6H4-11636-00	264
REC6H4-11636-01K	6H4-11636-01	237-263
REC6H4-11641-00	6H4-11641-00	237-261
REC6H4-14198-01	6H4-14198-01	274
REC6H4-14198-09	6H4-14198-00	274
REC6H4-14984-00	6H4-14984-00	94
REC6H4-14985-01	650-14385-00	100
REC6H4-14985-01	6H4-14985-00	100
REC6H4-14985-01	6H4-14985-01	100
REC6H4-14985-01	6M6-14385-00	100
REC6H4-14985-01	6H4-15369-A1	237
REC6H4-41112-A0	6H4-41112-A0	141-237
REC6H4-41114-A0	6H4-41114-A0	141-237
REC6H4-41134-A0	6H4-41134-A0	269
REC6H4-44352-02	6H4-44352-00	309
REC6H4-44352-02	6H4-44352-02	143-297-301-305-355-357-359-361
REC6H4-44352-02	6H4-44352-02	154-155-156
REC6H4-45113-00	6H4-45113-00	237
REC6H4-45113-00	6H4-45113-A0	253-254
REC6H4-45551-00	6H4-45551-00	359-389-390
REC6H4-45560-00	6H4-45560-00	359-389-390
REC6H4-45570-00	6H4-45571-00	359-389-390
REC6H4-45631-00	6H4-45631-00	389-390
REC6H4-W0001-04	6H4-W0001-04	237-250
REC6H4-W0001-21	6H4-W0001-21	359
REC6H4-W0001-A1	6H4-W0001-01	250-254
REC6H4-W0078-00	6H4-W0078-00	151
REC6H4-W0078-00	6H4-W0078-A0	359
REC6H4-W0078-00	6H4-W0078-A0	155-156
REC6H4-W0093-01-00	6H4-W0093-01	96
REC6H4-W0093-03	6H4-W0093-03	96-237
REC6H9-45551-00	6H9-45551-00	365-389
REC6J1-11610-00	6J1-11610-00	221
REC6J8-11181-A2	6J8-11181-A1	231
REC6J8-11181-A2	6J8-11181-A2	248
REC6J8-11181-A2	6J8-11181-A2	254
REC6J8-11631-02	6J8-11631-02-97	231-263-266
REC6J8-13411-00	6J8-13411-00	83

REF	R.O. / OEM	
REC6J8-24471-00	6J8-24471-00	87
REC6J8-45113-00	6J8-45113-A0	231-253-254
REC6J8-85540-H2	6J8-85540-H2	120
REC6J8-W0001-21	6J8-W0001-21	145-357
REC6J8-W0078-A2	6J8-W0078-A1	150-151
REC6J8-W0078-A2	6J8-W0078-A2	155-357
REC6J9-45332-00-CA	6J9-45332-00-CA	327-379-391-392
REC6J9-45611-00	6J9-45611-01	327-379-391-392
REC6K1-82510-07	6K1-82510-06	113
REC6K1-82570-13	6K1-82570-13	128
REC6K4-11422-00	6K4-11422-00	256
REC6K4-11432-00	6K4-11432-00	256
REC6K4-11651-00	6K4-11651-00	260
REC6K5-11601-02	6K5-11601-02	241-262-264-266
REC6K5-11601-12	6K5-11601-12	241-262-264
REC6K5-11601-22	6K5-11601-22	241-262-264
REC6K5-11631-03K-95	6K5-11631-03-95	264-266
REC6K5-11635-03K	6K5-11635-03	264
REC6K5-11636-03K	6K5-11636-03	264
REC6K5-11681-00	6K5-11681-00	261
REC6K5-14301-03 +	6K5-14302-03 +	92-93
REC6K5-14302-03 +	6K5-14303-03	
REC6K5-45551-00	6K5-45551-00	388-390
REC6K5-45560-00	6K5-45560-00	388-390
REC6K5-45570-00	6K5-45570-00	390
REC6K5-W0001-02	6K5-W0001-02	251
REC6K5-W0078-01	6K5-W0078-01	152-156
REC6K7-11633-00	6K7-11633-00	261-265
REC6K7-13645-A2	6K7-13645-A2	276
REC6K7-13646-A2	6K7-13646-A2	276
REC6K7-W0093-09	6K7-W0093-09	97
REC6K8-41122-A1	6K8-41122-A1	141-229
REC6K8-41124-A1	6K8-41124-A1	141-229
REC6L2-11181-A1	6L2-11181-A3	248-254
REC6L2-11193-A1	6L2-11193-A1	255
REC6L2-13621-00	6L2-13621-00	274
REC6L2-14384-00-00	6L2-14384-00	94
REC6L2-14385-00	6L2-14385-00	93-100
REC6L2-14399-00	6L2-14399-00	94
REC6L2-26301-00	6L2-26301-00	129
REC6L2-41112-A3	6L2-411	

REF	R.O. / OEM	
REC6P3-WS24A-00	6P3-WS24A-00	81
REC6P3-WS24A-00	6P3-WS24A-01	81
REC6P3-WS24A-00	6P3-WS24A-01	71-72-73-81
REC6R3-11411-00	6R3-11411-00	256
REC6R3-81960-10	6R3-81960-10	116
REC6R3-82563-01	6R3-82563-00	122
REC6R3-82563-01	6R3-82563-01	122
REC6R3-85570-01	6R3-85570-01104	104
REC6R3-W0001-03	6R3-W0001-A3	252
REC6R4-13200-02	6R4-13200-00	84
REC6R4-13200-02	6R4-13200-01	84
REC6R4-13200-02	6R4-13200-02	84
REC6R5-11603-00	6R5-11603-00	265-266-267
REC6R5-11631-01K	6R5-11631-11-93	265-266-267
REC6R5-11631-11K	6R5-11631-11-93	245
REC6R5-11631-11K	6R5-11631-11-93	265
REC6R5-11631-11K	6R5-11631-11-93	266-267
REC6R5-11633-00	6R5-11633-10	245-247-261-265
REC6R5-11634-00	6R5-11634-00	265
REC6R5-11634-00	6R5-11634-10	245-247-265
REC6R5-11642-01K	6R5-11642-11-93	245-265-266-267
REC6R5-11642-11K	6R5-11642-11-93	265-266-267
REC6R5-11650-10	6R5-11650-10	247
REC6R5-11650-10	6R5-11650-00	245
REC6R6-W0001-02-00	6R6-W0001-02	250-254
REC6R7-11181-A0	6R7-11181-A1	248-254
REC6S1-41136-00	6S1-41136-00	270
REC6S1-85885-00	6S1-85885-00	90-102
REC6X2-85885-10	6X2-85885-00	103
REC6X2-85885-10	6X2-85885-10	103
REC703-48205-16	703-48205-10	126
REC703-48205-16	703-48205-11	126
REC703-48205-16	703-48205-12	126
REC703-48205-16	703-48205-13	126
REC703-48205-16	703-48205-14	126
REC703-48205-16	703-48205-15	126
REC703-48205-16	703-48205-16	126
REC703-48205-16	703-48205-17	126
REC703-48205-16	703-48205-18	126
REC703-48205-16	703-48205-1A	126
REC703-48205-16	703-48205-1B	126
REC703-48205-16	703-48205-20	126
REC703-48205-16	703-48205-21	126
REC703-48230-14	703-48230-10	126
REC703-48230-14	703-48230-11	126
REC703-48230-14	703-48230-12	126
REC703-48230-14	703-48230-13	126
REC703-48230-14	703-48230-14	126
REC703-48230-14	703-48230-15	126
REC703-48230-14	703-48230-16	126
REC703-48230-14	703-48230-17	126
REC703-48230-14	703-48230-18	126
REC703-48230-14	703-48230-1A	126
REC703-48230-14	703-48230-20	126
REC703-48230-14	703-48230-21	126
REC703-48230-14	703-48230-23	126
REC703-82510-44	703-82510-43	114
REC704-48205-R0	704-48205-11	127
REC704-48205-R0	704-48205-12	127
REC704-48205-R0	704-48205-13	127
REC704-48205-R0	704-48205-14	127
REC704-48205-R0	704-48205-15	127
REC704-48205-R0	704-48205-B0	127
REC704-48205-R0	704-48205-B1	127
REC704-48205-R0	704-48205-P0	127
REC704-48205-R0	704-48205-P1	127
REC704-48207-R0	704-48207-20	127
REC704-48207-R0	704-48207-21	127
REC704-48207-R0	704-48207-22	127
REC704-48207-R0	704-48207-30	127
REC704-48207-R0	704-48207-31	127
REC704-48207-R0	704-48207-39	127
REC704-48207-R0	704-48207-P1	127
REC704-48207-R0	704-48207-R0	127
REC704-82570-12	6E5-82570-05	128
REC704-82570-12	704-82570-08	128
REC704-82570-12	704-82570-10	128
REC704-82570-12	704-82570-11	128
REC704-82570-12	704-82570-12	128
REC70720		79
REC84419M	696-W0093-01	96
REC84419M	696-W0093-02	96
REC8542561	65W-W0093-02	95-190-197
REC855686		77
REC866169T01	6C5-13907-00	86
REC881346T	68V-81960-00	117
REC881346T	6D3-81960-00	117
REC89-825096T01	66G1-81941-10	114
REC89-825096T01	6E5-81950-01	114
REC89-825096T01	6G1-81940-00	114
REC89-825096T01	6G1-81941-10	110
REC90101-06M56	90101-06M56	353
REC90101-06M56	97095-06030	209
REC90105-06M01	90105-06M01	363
REC90109-08022	90109-08022	239-243-247
REC90109-08M71	90109-08M71	245
REC90119-06M10	90119-06M10	325-329-333-377-385
REC90119-08M13	90119-08M13	321-357-371-317-325-329-333-335-339-341-377-381-385-386
REC90119-08M14	90119-08M14	

REF	R.O. / OEM	
REC90119-08M15	90119-08M15	301-305-309-13-361
REC90119-08M21	90119-08M21	231
REC90119-08M33	90119-08M33	317
REC90119-08M87	90119-08M87	321
REC90149-06M00	90149-06M00	365
REC90151-05M00	90152-05000	315-319
REC90170-12138	90170-012138	365
REC90170-12138	90170-12138	299-303-307-311-359-361-369
REC90170-16M01	90170-16M01	315-319-323-327-371-375-379
REC90170-16M01	90170-16M01-00	373
REC90170-16M19	90170-16M19	331-335-337-383
REC90171-10M01	90171-10M01	289-291-293-405-351
REC90171-14013-00	90171-14013	295-353-355-357-405
REC90171-16011	90171-16011	299-303-307-311-315-319-359-361-365-369-371
REC90171-16011	90171-16011	405
REC90171-16011	90171-16011-00	373
REC90171-18M04	90171-18M04	323-327-331-335-337-341-375-379-383-405
REC90179-08M06	90179-08M06	291-293-348-351
REC90179-09M02	90179-09M02	353
REC90179-10M14	90179-10M14	295-355-357-315-319-331-335-337-341-373-383
REC90183-02M03	90183-02M03	331-335-337-341-383
REC90201-02M00	90201-02M00	341-383
REC90201-10M01	90201-10M01	289-405
REC90201-12565	90201-12565	225-260
REC90201-14377	90201-14377	227-260
REC90201-16M00	90201-16M00	331-335-337-383
REC90201-17682	90201-17682	291-293-349-351
REC90201-17M00	90201-17M00-00	373
REC90201-20417	90201-20417	233-235-239-241-243-260-261-353-355-357
REC90201-20M27	90201-20M27	229-260
REC90201-21M75	90201-21M75	245-247-261-299-303-307-359-361-365-369
REC90201-22429	90201-22429	325-329-333-377-381-385-245-247-261
REC90201-22M01	90201-22M01	323-327-375-379
REC90201-23M01	90201-23M01	331-383
REC90201-30M92	90201-30M92	339
REC90201-31M00	90201-31M00	227
REC90201-42014	90201-42014	339
REC90201-46M29	90201-46M29	227
REC90206-22M19	90206-22M19	325-329-333-377-381-385-221-223-225-260
REC90209-18112	90209-18112	227-260
REC90209-20159	90209-20M23	229-260-261
REC90209-24M03	90209-24M03	233-235-260-261
REC90209-27M07	90209-27M07	261
REC90209-27M11	90209-27M11	261
REC90214-48M03	90214-48M03	365-369
REC90250-03M10	90250-03M10	291-293-295-349-351-353-355-357
REC90250-05010	90250-05010	347
REC90250-05036	90250-05036	345
REC90250-05046	90250-05046	299-303-307-311-359-361-363-365-369-315-319-371
REC90250-06023	90250-06023	373
REC90250-07M02	90250-07M02	323-327-335-375-379
REC90250-07M02	90250-07M02-00	154-155-156-309-313-346-347-349-357-359
REC90250-08M07	90250-08M07	154-156-301-305-317-355-361-369-335
REC90280-03024	90280-03024	156-363-367-154-155-156-321-371
REC90280-03M03	90280-03M03	373
REC90280-04002	90280-04002	155-156-157-325-329-333-339-377-381-385-386
REC90280-04M00	90280-04M00	229
REC90280-04M04	90280-04M04-00	365
REC90280-04M04	90280-04M04-00	
REC90280-04M05	90280-04M05	
REC90280-05049	90280-05049	
REC90282-04010	90282-04010	

REF	R.O. / OEM	
REC90282-04010	90282-04010	315-319-323-353-357-359-369-371-373-375
REC90282-04M00	90282-04M00	327
REC90340-08002	6E0-45316-09	346
REC90340-08002	90340-08002	283-285-287-289-291-282-299-303-307-311-315-319-323-327-331-335-337-341-345-350-353-357-361-363-369-370-373-379-383
REC90340-08002	90340-08014	348-359
REC90340-08002	90340-08M04	295-343-347-365-375
REC90381-20001	90381-20001	133
REC90386-18M63	90386-18M63	133
REC90386-22M13	90386-22M13	133
REC90386-22M98	90386-22M98	133
REC90386-25M31	90386-25M31	133
REC90386-30M77	90386-30M77	133
REC90386-38M89	90386-38M89	133
REC90387-32002	90387-32002	229
REC90389-22M01	90389-22M01	299-303-307-311-361-365-405
REC90389-25M00	90389-25M00	315-319-371-405
REC90430-06M03	90430-06M03	209-211-213-214-347-363-365
REC90430-08020	90430-08003	292-303-307-311-315-323-283-285-287-289-291-299-327-331-335-337-341-343-345-346-347-348-350-353-355-357-359-361-363-365-369-370-375-379-383-386
REC90430-08020	90430-08020	295
REC90430-08020	90430-08020	64-65-66-67-68-69-70-71-72-73
REC90430-08020	90430-08020-00	373
REC90430-12072	90430-12072	301-305-309-361-367-371
REC90430-12072	90430-12072-00	373
REC90480-18065	90480-18065	235-239
REC90480-20M05	90480-20M05	139-209-211-243-245-247-331-335-337-341-383
REC90501-10M77	90501-10M77	329-333-339-381-385
REC90501-11M10-00	90501-11M10	315-319-373
REC90501-12M48	90501-12M48	235
REC90501-14M02	90501-14M02	369-371
REC90501-16233	90501-16233	359-365
REC90501-16M01	90501-16M01	139-209-211-243-245-247
REC90501-16M11	90501-16M11	323-327-375-379
REC90501-16M37	90501-16M37	339
REC90501-450A2	90501-450A2	78
REC90794-46866	907-94469-05	78
REC90794-46866	907-94469-13	78
REC91490-30025	91490-30020	289-291-293-351
REC91490-30025	91490-30025	64-65-67-68-69-299-303-307-311-315-357-361-365-405
REC91490-30030	91490-30030	353-359-405
REC91490-30040	91490-30040	343
REC91490-40030	91490-40025	319-369-371-68-69-70-71-72-73-323-327-331-335-337-341-375-379-383-405
REC91490-40030	91490-40030-00	373
REC92990-16200	92990-16200	359-369-405
REC92990-18200	92990-18200	323-327-331-335-337-375-379-405
REC93101-10M14	93101-10M14	345
REC93101-10M25	93101-10M25	221
REC93101-11M23	93101-11M23	289-346
REC93101-12M70	93101-12M70	341
REC93101-13018	93101-13018	227
REC93101-13M12	93101-13M12	287-345
REC93101-13M27	93101-13M27	270
REC93101-14M01	93101-14M01	225
REC93101-15074	93101-15074	289-346-347
REC93101-16001	93101-16001	229-233
REC93101-17054	93101-17054	291-293-349-351
REC93101-18050	93101-18050	347
REC93101-20048	93101-20011	292
REC93101-20048	93101-20048	291-349-351-363

YAMAHA

RECAMBIOS MARINOS

REF	R.O. / OEM	
REC93101-20M07	93101-20M07	295-353-355-357
REC93101-20M29	93101-20M29	221-225
REC93101-20M34	93101-20M34	223
REC93101-22067	93101-22067	353-355-359-365-367-369
REC93101-22M00	93101-22067	297
REC93101-22M00	93101-22M00	299-303-307-311-361-363
REC93101-22M15	93101-22M15	245-247
REC93101-22M60	93101-22M60	301-305-361
REC93101-23070	93101-23070	317-357-359-369
REC93101-25018	93101-250-18	227
REC93101-25M03	93101-25M03	315-319-321-371
REC93101-25M03	93101-25M03-00	373
REC93101-25M35	93101-25M28	231
REC93101-25M57	93101-25M57	309-313
REC93101-28M16	93101-28M16	325-329-333-335-339-377-381-385-386
REC93101-30002	93101-300002	335-337
REC93101-30M17	93101-30M17	323-327-331-375-379-383
REC93101-30M33	93101-30M33	235
REC93102-15M32	93102-15M32	220
REC93102-20M25	93102-20M25	223-225
REC93102-23096	93102-23096	237
REC93102-25008	93102-25008	229
REC93102-25M28	93102-25M28	237
REC93102-25M48	93102-25M48	227
REC93102-26M27	93102-26M27	231
REC93102-28135	93102-28135	239
REC93102-30M05	93102-30M05	243
REC93102-30M23	93102-30M23	241
REC93102-30M56	93102-30M56	233
REC93102-32M07	93102-32M07	229-239
REC93102-35M13	93102-35M13	245-247
REC93102-35M18	93102-35M18	235
REC93102-36M02	93102-36M02	243
REC93102-36M24	93102-36M24	241
REC93102-38008	93102-38008	211-213
REC93102-38008	93102-38M59	209
REC93102-40M14	93102-40M14	245-247
REC93102-48009	93102-48009	209
REC93102-60004	93102-60004	211
REC93102-63004	93102-63008	213
REC93103-10052	93103-10052	343
REC93103-11051	93103-11051	343
REC93104-16M01	93104-16M01	235-237
REC93104-16M01	93104-16M04	231
REC93104-18049	93104-18049	239
REC93104-20M02	93104-20M02	243
REC93104-22M07	93104-22M07	335
REC93106-09014	93106-09014	305-309-313-317-321-325-329-333-335-339-369-371-377-381-385
REC93106-09014	93106-09014-00	373
REC93106-18M01	93106-18M01	241
REC93109-44M00	93109-44M00	132
REC93110-23M00	93110-23M00	227
REC93210-06ME6	93210-06ME6	289-291-292-297-301-351-361
REC93210-07540	93210-07003	329
REC93210-19MJ1	93210-19MJ1	211-213
REC93210-22M02	93210-22M02	235
REC93210-25552	93210-25552	211-213
REC93210-32738	93210-32738	65-66-68-69
REC93210-33MG4	93210-33MG4	301-305-309-313-361
REC93210-37160	93210-37160	325-329-333-335-339-341-377-381
REC93210-37M67	93210-37M67	385-386
REC93210-41042	93210-41042	357-359-367-369
REC93210-42101	93210-42101	343
REC93210-42159	93210-42159	223-225-231-239
REC93210-42M70	93210-42M70	225
REC93210-44398	93210-44398	154-155-289-291
REC93210-45161	93210-45161	155
REC93210-46044	93210-46044	317-321-371
REC93210-46044	93210-46044-00	373
REC93210-46M16	93210-46M16	227-229-241-243
REC93210-48214	93210-48214	287-341-345
REC93210-48MG8	93210-48MG8	301-309-361
REC93210-49046	93210-49046	154-289-293-317-321-346-359-369-371
REC93210-49046	93210-49046-00	373
REC93210-53M08	93210-53M08	289-346
REC93210-54534	93210-54534	333-339-385
REC93210-54534	93210-55M14	325-329-377-381
REC93210-54M54	93210-54M54	223
REC93210-57M00	93210-57M00	363
REC93210-57M09	93210-57M09	291-293-349-351
REC93210-58677	93210-58144	325-329-377-381
REC93210-58677	93210-58677	347

REF	R.O. / OEM	
REC93210-58M21	93210-58M21	229-237
REC93210-59MG7	93210-59MG7	154-156-301-305-309-313-361
REC93210-60MA3	93210-60MA3	357
REC93210-62269	93210-62269	239-243
REC93210-64ME7	93210-64ME7	295-355
REC93210-65752-00	93210-64488	333-335
REC93210-65M50	93210-65M50	233-235-241-295-355
REC93210-66M98	93210-66M98	359-365-369
REC93210-69MG6	93210-69MG6	299-303-307-311-341-361
REC93210-74M35	93210-74M35	245-247
REC93210-74MG5	93210-74MG5	299-303-311-361
REC93210-85M97	93210-85M97	371
REC93210-85M97	93210-85M97-00	373
REC93210-86M38	93210-86M38	155-156-157-325-329-333-339-377-381-385-386
REC93210-86M39	93210-86M39	315-319-323-375
REC93210-94003	93210-94003	335-341
REC93210-97M55	93210-97M55	327-379
REC93211-04001	93211-04001	245-247
REC93211-04384	93211-04384	331-337-383
REC93304-205U0	93304-205U0	257
REC93306-001U1	93306-001U1	299-303-307-311-361-394-395-396
REC93306-00501	93306-00501	291-293-349-351-393-394
REC93306-00519	93306-00519	347-393
REC93306-00612	93306-00612	353-355-357-394-395
REC93306-00702	93306-00702	359-365-369-394-395-396
REC93306-204U0	93306-204U0	221-223
REC93306-204U0	93306-240U0	225-257
REC93306-204Y7	93306-20401	363
REC93306-205U2	93306-205U7	257
REC93306-205U7	93306-205U7	227-257
REC93306-206U5	93306-206U5	243-258
REC93306-207U0	93306-207U0	315-319-371-395-396-397
REC93306-207U0	93306-207U0-00	373
REC93306-208U0	93306-208U0	245-247-258-259-323-375-393-397
REC93306-209U0	93306-209U0	397-398-399-400
REC93306-209U1	93306-209U1	259
REC93306-210U0	93306-210U0	331-337-383-399-400
REC93306-304U0	93306-304U0	257
REC93306-30510	93306-30510	257-258
REC93306-305U3	93306-305U3	229-231-257-258
REC93306-305U8	93306-305-U8	237-258
REC93306-306V1	93306-303V1	235
REC93306-306V1	93306-306V1	241-257-258
REC93306-306V5	93306-306V5	233-258
REC93306-307U0	93306-307U0	233-235-258
REC93310-112V0	93310-112V0	221-223-257-262
REC93310-32337	93310-323V6	245
REC93310-32337	93603-21111	265
REC93310-32337	93310-32337	247-258-259-265
REC93310-32668	93310-32668	247
REC93310-326V4	93310-326V4	259
REC93310-418U0	93310-418U0	225-257
REC93310-418V1	93310-418V1	221-223-257
REC93310-522W0	93310-522W0	257-258
REC93310-527W1	93310-527W1	258
REC93310-620V5	93310-620V5	227-257
REC93310-624U5	93310-624U5	229-257-258
REC93310-636U4	93310-636U4	243-258
REC93310-727U0	93310-727U0	233-258
REC93310-727V7	93310-727V7	235-258
REC93310-730V6	93310-730V6	258
REC93310-730V8	93310-730V8	239-243-258
REC93310-835U8	93310-835U8	243-258
REC93310-836U0	93310-836U0	258-259
REC93310-836V2	93310-836V2	245-247-258-259
REC93310-954U1	93310-954U1	245-247-258-259
REC93310-954V3	93310-954V3	258-259
REC93310-959U0	93310-959U0	247
REC93311-632U1	93311-632U1	239-258
REC93311-632U7	93311-632U7	231-257
REC93311-632V4	93311-632V4	257-258
REC93311-636U6	93311-636U6	241-257-258
REC93311-83280	93311-83280	331-335-337-383-399-400
REC93311-832U4	93311-832U4	239-258
REC93311-858U4	93311-858U4	335
REC93311-928U5	93311-928U5	329-381-397-398-399-400
REC93311-940U3	93311-940U3	245-247-258-259
REC93311-940V0	93311-940V0	247
REC93315-017U4	93315-017U4	353-394-395
REC93315-217U0	93315-217U0	363-395

REF	R.O. / OEM	
REC93315-22004	93315-22004	295-353-355-357-394-395
REC93315-220V7	93315-220V7	355-357-394-395
REC93315-314V8	93315-314V8	291-292-351-393-394
REC93315-317U2	93315-317U2	291-293-349-351-393-394
REC93315-32224	93315-32224	301-305-309-313-359-361-367-369-394-395-396
REC93315-324U1	93315-324U1	363-395
REC93315-325V1	93315-325V1	371-394-395-396
REC93315-325V1	93315-325V1-00	373
REC93315-425U7	93315-425U7	323-375-396-397
REC93315-425V3	93315-425V3	327-379-397-398-399-400
REC93315-43061	93315-43061	327-331-335-379-383-397-398-399-400
REC93315-430U8	93315-430U8	323-375-396-397-398-399-400
REC93315-430V5	93315-430V5	396-397-398-399-400
REC93315-628U9	93315-628U9	325-377-396-397-398
REC93317-22204	93317-22204	299-303-307-311-359-361-365-369-394-395-396
REC93317-322V0	93317-322V0	315-319-396-397
REC93317-325U0	93317-325U0	315-319-371-396-397
REC93317-325U0	93317-325U0-00	373
REC93317-330U2	93317-330U2	325-329-333-339-377-381-385-396-397-398-399-400
REC93332-00001	93332-00001	301-305-309-313-357-361-369-394-395-396
REC93332-00003	93332-00003	291-293-295-349-351-353-355-393-394-395
REC93332-00005	93332-00005	395
REC93332-00023	93332-00023	394-395-396
REC93332-00048	93332-00048	327-331-397-398-399-400
REC93332-000A5	93332-000A5	335
REC93332-000U0	93332-000U0	363-395
REC93332-000U3	93332-000U3	317-321-371-396-397
REC93332-000U3	93332-000U3-00	373
REC93332-000U5	93332-000U5	396
REC93332-000U7	93332-000U7	323-375-396-397
REC93332-000U7	93332-000U7	233-235-258
REC93332-000V3	93332-000V3	327-379-397-398-399-400
REC93332-000W1	93332-000W1	331-337-383-399-400
REC93332-000W5	93332-000W5	355-394-395
REC93332-000W7	93332-000W7	371-394-395-396
REC93332-000W7-00	93332-000W7-00	373
REC93340-67011	93340-67011	335-341
REC93341-214U1	93314-314V8	291
REC93341-214U1	93341-214U1	348-393-394
REC93341-41414	93341-41414	351-393-394
REC93341-93020	93341-93020	333-385
REC93341-93020	93341-930U9	339
REC93341-930V2	93341-930V2	325-329-377-381-396-397-398-399-400
REC93342-624U0	93342-624U0	363
REC93390-000U0	93390-000U0	363-395
REC93390-000U2	93390-000U2	397-398-399
REC93399-99951	93399-99951	229-257
REC93440-52009	93440-52008	227
REC93440-68M03	93440-68M03	233-235
REC93450-13022	93450-13022	221-223-225-262
REC93450-15023	93450-15023	227-262
REC93501-04011	93501-04011	331-335-337-341-383
REC93503-16003	93503-16003	315-319-323-327-373-375-379
REC93507-32031	93507-32009	323-327
REC93507-32031	93507-32031	375-379
REC93511-32027	93511-32017	327
REC93511-32027	93511-32027	323-375-379
REC93602-14104	93602-14104	227-257-262
REC93602-14118	93602-14118	225-257-262
REC93602-18M12	93602-18M12	229
REC93602-20M02	93602-20M02	229-237-257-258-263-264
REC93603-1		

REF	R.O. / OEM	
REC93603-21111	93603-21111	233-235-239-243-258-259-263-264-265
REC93606-12019	90606-12019	205
REC93606-12019	93606-11M24	297
		187-195-201-203-207-209-211-213-214-221-227-229-231-237-299-303-307-311-315-319-325-329-333-335-339-341-349-367-371-377-381-385
REC93606-12019	93606-12019	386
REC93608-12M05	93608-12M05	323-331-337-341-383
REC95380-06700	95380-06700	301-361
REC97075-10040	97075-10040	299-303-307-311-319-369-370
REC97080-08045	97080-08045	289-291-351
REC97095-06040	97095-06040	347-355
REC97095-06045	97095-06045	211-287-346
REC97095-08045	97095-08045	293-363-367-369
REC97095-08045	97395-08045	359
REC97095-08055	97095-08055	363-367-369
REC97095-08055	97395-08055	359
REC97395-08070	97395-08070-00	373
REC99001-06600	99001-06600	287-346
		305-309-313-317-321-325-329-333-335-339-369-371-377-381-385
REC99001-08600-00	99001-08600	337-383
REC99590-10114	99590-10114	134
REC99999-02808	99999-02808	209
RECK0A-A3721-00	K0A-A3721-00	209
RECK0A-A3722-00	K0A-A3722-00	209
RECKITF100D		70
RECKITF100F		70
RECKITF115A		70
RECKITF115B		71
RECKITF150CR		71
RECKITF150G		72
RECKITF150RR		71
RECKITF15C		65
RECKITF2.5A		64
RECKITF2.5B		64
RECKITF200A		72
RECKITF200C		72
RECKITF20A		65
RECKITF20B		65
RECKITF225B		72
RECKITF225C		73
RECKITF250D		73
RECKITF25A		66
RECKITF25D		66
RECKITF25G		66
RECKITF300A		73
RECKITF30A		67
RECKITF30B		67
RECKITF350A		73
RECKITF40B		67
RECKITF4A		64
RECKITF50A		67
RECKITF50F		68
RECKITF5A		64
RECKITF60A		69
RECKITF6A		64
RECKITF6C		64
RECKITF70A		69
RECKITF80A		69
RECKITF80B		70
RECKITF9.9C		65
RECKITF25B		66
RECKITF25F		66
RECKITF50B		68
RECKITF50C		68
RECKITF50G		68
RECKITF60B		69
RECKITF8D		65
REC26-13440-00	N26-13440-00	83-214
REC26-13440-00	N26-13440-02	73-83
RECOBBRACKET		77
RECOBELEMENT		78
RECOBFILALU		78
RECOBFILTER		78
RECPIN4		125
RECPIN4.5		125
RECPIN6		125
RECTOOLTRIM1		125
RECTOOLTRIM2		125
RECTOOLTRIM3		125
RECTOOLTRIMKIT		125
RECYS-225-15		78
RM35-802893Q		78
RM92-858026QB1U6	92-858026QB1	84
RM92-858027QB1U3	92-858027QB1	84
RM92-8M0086220U6	92-8M0086220	84
RM92-8M0086221U3	92-8M0086221	84

**S**  
SIE18-8013 74

REF	R.O. / OEM	
SIE18-8015		74
SOL2011-083-08P		402
SOL3011-073-05S	6L5-45949-00-EL	402
SOL3011-075-07S	6E0-45943-01-EL	402
SOL3011-085-07	6G1-45947-00-EL	402
SOL3011-085-08	6G1-45943-00-EL	402
SOL3011-085-09	6G1-45941-00-EL	402
SOL3011-090-07-P	647-45943-00-EL	402
SOL3111-093-07		402
SOL3111-093-08	683-45947-00-EL	402
SOL3111-093-09	683-45945-00-EL	402
SOL3111-093-10	683-45942-00-EL	402
SOL3111-093-11	683-45943-00-EL	402
SOL3111-093-12	683-45941-00-00	402
SOL3211-099-09	664-45941-01-EL	402
SOL3211-099-10	664-45945-00-EL	402
SOL3211-099-11	664-45947-01-EL	402
SOL3211-099-12	664-45954-00-EL	402
SOL3211-099-13	664-45949-02-EL	402
SOL3231-101-13	MAR-6YT30-02-12	402
SOL3231-103-12	664-45970-00-98	402
SOL3231-105-11	664-45972-00-98	402
SOL3231-108-10		402
SOL3311-110-15	663-45943-02-EL	402
SOL3311-110-16	663-45949-01-EL	402
SOL3311-110-17	663-45941-01-EL	402
SOL3311-111-13	663-45945-02-EL	402
SOL3311-111-14	663-45958-01-EL	402
SOL3311-114-12	663-45952-02-EL	402
SOL3311-115-10-P		402
SOL3311-115-11-P		402
SOL3311-115-12-P		402
SOL3311-116-11	663-45947-02-EL	402
SOL3311-121-09	663-45956-01-EL	402
SOL3331-111-13	663-45945-02-EL	402
SOL3331-111-14	663-45958-01-EL	402
SOL3331-114-12	663-45970-60-98	402
SOL3331-116-11	663-45972-60-98	402
SOL3331-119-10	663-45954-01-EL	402
SOL3411-130-19	6E5-45941-00-EL	402
SOL3411-130-21	6E5-45943-00-EL	402
SOL3411-133-17	6E5-45945-00-EL	402
SOL3411-135-15	6E5-45947-00-EL	402
SOL3411-138-13	6E5-45949-00-EL	402
SOL3411-140-11	6E5-45954-00-EL	402
SOL3412-133-17		402
SOL3412-135-15		402
SOL3412-138-13		402
SOL3413-125-19	6E5-45941-00-EL	402
SOL3413-125-21	6E5-45943-00-EL	402
SOL3413-128-17	6E5-45945-00-EL	402
SOL3413-130-15	6E5-45947-00-EL	402
SOL3413-133-13	6E5-45949-00-EL	402
SOL3431-130-19	688-45970-03-98	402
SOL3431-130-21	688-45972-02-98	402
SOL3431-133-17	688-45930-02-98	402
SOL3431-135-15	688-45978-60-98	402
SOL3432-130-19		402
SOL3432-133-17		402
SOL3511-142-23	6G5-45949-00-98	403
SOL3511-143-21	6G5-45949-00-98	403
SOL3511-145-19	6G5-45945-01-98	403
SOL3511-148-17	6G5-45947-01-98	403
SOL3511-150-15	6G5-45941-00-98	403
SOL3512-142-23	6G5-45949-00-98	403
SOL3512-143-21		403
SOL3512-145-19	6K1-45945-01-98	403
SOL3512-148-17	6K1-45947-00-98	403
SOL3512-150-15	6G5-45952-00-98	403
SOL3513-140-21	6G5-45949-00-98	403
SOL3513-143-19	6G5-45945-01-98	403
SOL3513-145-17	6G5-45947-01-98	403
SOL3513-148-15	6G5-45941-00-98	403
SOL3514-140-21		403
SOL3514-143-19	6K1-45945-01-98	403
SOL3514-145-17	6K1-45947-00-98	403
SOL3514-148-15	6G5-45952-00-98	403
SOL3531-140-19	6G5-45974-03-98	403
SOL3531-140-21	6G5-45972-02-98	403
SOL3531-140-23	6G5-45976-01-98	403
SOL3531-143-17	6G5-45978-03-98	403
SOL3531-145-15	6G5-45970-02-98	403
SOL3532-140-19	6K1-45974-02-98	403
SOL3532-140-21	6K1-45972-01-98	403
SOL3532-140-23	6K1-45976-00-98	403
SOL3532-143-17	6K1-45978-02-98	403
SOL3532-145-15	6K1-45970-01-98	403
SOL3571-145-25		403
SOL3571-145-27		403
SOL3571-148-23	6G5-45949-00-98	403
SOL3571-150-21	6G5-45949-00-98	403
SOL3571-153-19	6G5-45945-01-98	403
SOL3571-155-17	6G5-45947-01-98	403
SOL3571-158-15	6G5-45941-00-98	403
SOL3572-148-23		403
SOL3572-150-21		403
SOL3572-153-19	6K1-45945-01-98	403
SOL3572-155-17	6K1-45947-00-98	403
SOL3572-158-15	6G5-45952-00-98	403
SOL9311-110-15		404
SOL9311-111-13		404
SOL9311-111-14		404
SOL9311-114-12		404
SOL9311-116-11		404

REF	R.O. / OEM	
SOL9311-120-10		404
SOL9311-121-09		404
SOL9331-110-15		404
SOL9331-111-13		404
SOL9331-111-14		404
SOL9331-114-12		404
SOL9331-116-11		404
SOL9411-132-19		404
SOL9411-132-21		404
SOL9411-133-17		404
SOL9411-135-15		404
SOL9411-138-13		404
SOL9411-140-09		404
SOL9411-140-11		404
SOL9431-130-19		404
SOL9431-130-21		404
SOL9431-133-17		404
SOL9431-135-15		404
SOL9431-138-13		404
SOL9432-130-19		404
SOL9432-133-17		404
SOL9432-135-15		404
SOL9432-138-13		404
SOL9511-143-21		404
SOL9511-145-19		404
SOL9511-148-17		404
SOL9511-150-15		404
SOL9511-153-13		404
SOL9511-155-11		404
SOL9511-160-13		404
SOL9531-140-19		404
SOL9531-140-21		404
SOL9531-140-23		404
SOL9531-143-17		404
SOL9531-145-15		404
SOL9532-140-19		404
SOL9532-140-21		404
SOL9532-140-23		404
SOL9532-143-17		404
SOL9532-145-15		404
SOL9571-145-25		404
SOL9571-148-23		404
SOL9571-150-21		404
SOL9571-153-19		404
SOL9571-155-17		404
SOL9571-158-15		404
SOL9572-145-25		404
SOL9572-148-23		404
SOL9572-150-21		404
SOL9572-153-19		404
SOL9572-155-17		404
SOL9572-158-15		404
SOLRBX-102		405
SOLRBX-103		405
SOLRBX-108		405
SOLRBX-117		405
SOLRBX-127		405
STA93900		136
STA93922		136
STA93932		136
STA94100		136
TEN01100	664-45371-01	164-169
TEN01100AL	664-45371-01	164-169
TEN01101	679-45371-00	164-169-365-369
TEN01101AL	679-45371-00	164-169
TEN01102		164
TEN01103	6L6-45371-00	164-169
TEN01103AL	6L6-45371-00	164-169
TEN01104	688-45371-02	164-169
TEN01104AL	688-45371-02	164-169
TEN01105	6E5-45251-00	164-169
TEN01106	6E8-45251-00	164
TEN01107		165
TEN01108	6G1-45251-02	165-169
TEN01109	676-45251-00	163-169
TEN01110	688-45251-01	163-169
TEN01111		163
TEN01112	6G5-45251-01	166-169
TEN01112	6G5-45251-02	166-169
TEN01112AL	6G5-45251-01	166-169
TEN01112AL	6G5-45251-02	166-169
TEN01112-1	6AW-45251	166-169
TEN01113	6H1-45251-03	166-169
TEN01114		167
TEN01115	6H1-45251-02	166-169
TEN01115AL	6H1-45251-02	166-169
TEN01116	6B4-45251-00	348
TEN01116	6E8-45251-02	164
TEN01116	6B4-45371-00	169
TEN01117	6L5-45251-02	166-169
TEN01118	6G1-45251-03	164
TEN01118	6N0-G5251-00	346
TEN01118	6G1-45251-03	169
TEN01119	6T5-45371-00	165
TEN01120	6T5-45373-00	166
TEN01121	689-11325-00	167-229
TEN01122	6T4-45836-00	164
TEN01123	65W-45251-00	164-169
TEN01123	6E0-45251-11-00	164-169
TEN01123AL	65W-45251-00	164-169
TEN01123AL	6E0-45251-11-00	164-169
TEN01124	6T4-45371-00	165-169

YAMAHA

RECAMBIOS MARINOS

REF	R.O. / OEM	
TEN01124AL	61A-45371-00	165-169
TEN01125	6H1-45251-01	167
TEN01126		167
TEN01127	676-45251-00	166-233-235
TEN01128	682-45251-00	166
TEN01129	6E5-45251-00	165
TEN01130	61N-45371-00	165-355
TEN01131	63D-45251-00	165
TEN01131	63D-45251-01	165
TEN01131	63D-45251-00	169
TEN01132	63D-45251-10	163
TEN01132	67C-45251-00	163
TEN01132	63D-45251-10	169
TEN01133	6J9-45371-01	165-169
TEN01133AL	6J9-45371-01	165-169
TEN01134	6K1-45371-02	165-169
TEN01135	61N-45251-01	163-169
TEN01135AL	61N-45251-01	163-169
TEN01136	66M-45371-00	65-164-169
TEN01137	6G8-45251-00	164-169
TEN01138	6AV-45251-00	164
TEN01138	6V3-45251-01	164
TEN01139	6T5-45251-00	167
TEN01140	67F-45371-00	165
TEN01141	67F-45371-00	165-169
TEN01141AL	67F-45371-00	165-169
TEN01142	68T-45251-00	163-169
TEN01143	6J9-45371-00	165
TEN01144	6K1-45371-00	168-169

REF	R.O. / OEM	
TEN01144AL	6K1-45371-00	168-169
TEN01145	69L-45371-00	168-169
TEN01146	67F-11325-00	163
TEN01146-1	67F-11325-01	163
TEN01147	688-11325-00	163-237-243
TEN01148	6G8-11325-00	163-169
TEN01149	62Y-11325-00	163
TEN01150	6J8-11325-00	163-229-231
TEN01151	66M-11325-00	163
TEN01152	6E5-11325-00	163-169-245-247
TEN01153	6E5-45371-00	164
TEN01153	6E5-45371-10	370-375
TEN01154	6AH-45251-00	169
TEN01154AL	6AH-45251-00	65-165
TEN01155	6AW-45373-00	166-169
TEN01155AL	6AW-45373-00	166-169
TEN01156	68V-11325-02	72-167
TEN01156AL	68V-11325-02	72-167
TEN01156-1	68V-11325-01	167
TEN01156/1AL	68V-11325-01	167
TEN01157	6U0-45251-00	165-169
TEN01158	6U4-45373-00	166-169
TEN01159	6U4-45251-00	167-169
TEN01160T	N51-11325-01	167
TEN01161	6BL-11325-00	166
TEN01162	682-11325-00	166-227
TEN01163	68T-11325-00	166
TEN01164	63P-11325-11-00	166-169

REF	R.O. / OEM	
TEN01165	63P-11325-21	211
TEN01165	63P-11325-21-00	163
TEN01165	63P-11325-21	70-71
TEN01166	664-11325-00	225
TEN01166	676-11325-00	166-233-235
TEN01167	63P-11325-01-00	166-169
TEN01168	61A-11325-00	163
TEN01169	6AW-45619-00	165
TEN01170	6AW-11325-00	214
TEN01170	6AW-11325-00	167
TEN01170	6AW-11325-00	73-169
TEN01171	6AQ-1132N-00	73-167-169-214
TEN01172	6AW-1132R-00	214
TEN01173	6AW-1132L-00	73-167-169
TEN01174	6AW-1132U-00	73-167
TEN01175	6AW-1132T-00	73-167-169
TEN01176	6AW-1132M-00	167-169
TEN01177	6AW-1132P-00	73-168-169-214
TENKITYAMAHA150-200		168
TENKITYAMAHA150-200C		168
TENKITYAMAHA200-250		168
TENKITYAMAHA200-300		168
TENKITYAMAHA40-60		168
TENKITYAMAHA60-90		168
TRI305-0386		74
TRI305-0566		74

## RO / OEM --> REF

R.O. / OEM	REF	
137-11633-10	PAF20-05020003	189-219
30X-12117-00	PAF15-07040006	189-193-195-199-201-203-207
30X-12117-00	PAF15-07050006	185
30X-12118-00	PAF15-07040007	185-189-193-195-199-201-203-207
3FV-13440-00	REC3FV-13440-00	83
3FV-13440-10	REC3FV-13440-00	83
3FV-13440-20	REC3FV-13440-00	83
3FV-13440-30	REC3FV-13440-00	67-83
3YF-12113-00	PAF20-05030004	189
41106-ZW-000	CM41106-ZW000	158
50M-14355-00	REC50M-14355-00	99
51Y-12114-00	PAF25-05050005	193-195-199-201-203-207
51Y-12119-00	PA166F-010003	173-180-189-195-201
51Y-12119-00	PAF166-010003	179-193
51Y-12119-00	PAPS2700.04.03	175-185-199-203-205-207-213
5GH-13440-00	PAF15-07010023	183
5GH-13440-00	PAF25-05000100	191
5GH-13440-00	REC5GH-13440-00	83-183-191-197-209
5GH-13440-10	REC5GH-13440-00	207
5GH-13440-20	REC5GH-13440-60	195-203
5GH-13440-30	REC5GH-13440-00	83
5GH-13440-50	REC5GH-13440-60	83-201-205
5GH-13440-60	REC5GH-13440-60	65-66-67-68-69-83-187
5GH-13440-70	REC5GH-13440-00	65-66-67-68-69-70-71-83
60E-81950-00	REC60E-81950-00	115
60H-12416-00	REC60H-12416-00	245-247
60R-12113-00	PAF6-04050003	179
60R-E2414-A0	REC60R-E2414-A0	180
60R-G6241-00	REC60R-G6241-00	180
60V-11181-00	REC60V-11181-00	249-254
60V-12411-00	REC60V-12411-00	70-137
60V-13621-A0	REC60V-13621-A0	276
60V-13645-00	REC60V-13645-00	276
60V-13907-00	REC60V-13907-00	86
60V-24251-01	REC60V-24251-01	82
60V-43880-00	PH200-T069	123
60V-44150-00	REC60V-44150-00	385
60V-45113-02	REC60V-45113-02	254
60V-45300-20-8D	REC421-A25	281
60V-45332-00-94	REC60V-45332-00-94	383
60V-45611-00	REC60V-45611-00	383
60V-81800-00	PH130-0076	112
60V-81950-00	REC60V-81950-00	115
60V-81960-00	REC60V-81960-05	117
60V-81960-01	REC60V-81960-05	117
60V-81960-02	REC60V-81960-05	117
60V-81960-03	REC60V-81960-05	117
60V-81960-04	REC60V-81960-05	117
60V-81960-05	REC60V-81960-05	117
60W-45300-20-8D	REC428-A25	281
60X-44315-A0	REC60X-44315-A0	339-386
60X-81800-00	PH130-0076	112
60X-W0078-00	REC60X-W0078-00	153-157-386

R.O. / OEM	REF	
612-45611-00	REC612-45611-00	295
61A-11193-A2	REC61A-11193-A2	255
61A-11325-00	CM61A-11325-00	161
61A-11325-00	TEN01168	163
61A-11381-A0	REC61A-11381-A0	276
61A-11650-00	REC61A-11650-00	261
61A-12414-A0	REC61A-12414-A0	138-231
61A-13411-00	REC61A-13411-00	83
61A-13621-A0	REC61A-13621-A0	276
61A-13645-00	REC61A-13645-00	276
61A-13646-00	REC61A-13646-00	276
61A-24563-00	REC61A-24563-00	81-82
61A-43811-00	REC48630-92J00	125
61A-43821-00	REC48630-94900	125
61A-43821-09	REC48630-94900	125
61A-43880-00	PH200-T050	124
61A-43880-01	PH200-T050	124
61A-44311-00	REC61A-44311-00	155-156-157-385
61A-44311-01	REC61A-44311-00	325-329-333-339-377-381-386
61A-44322-02	REC61A-44322-02	155-156-157-325-329-333-339-377-381-386
61A-45113-A0	REC61A-45113-A0	254
61A-45214-10	REC61A-45214-10	383
61A-45214-11	REC61A-45214-10	331
61A-45215-10	REC61A-45215-10	383
61A-45215-11	REC61A-45215-10	331
61A-45321-01	REC61A-45321-01	333-385
61A-45331-00-94	REC61A-45331-00-94	333-385-386
61A-45371-00	CM61A-45371	160-169-383
61A-45371-00	CM61A-45371-00A	160-169-331-335-337
61A-45371-00	TEN01124	165-169
61A-45371-00	TEN01124AL	165-169
61A-45376-00	REC61A-45376-00-94	333-339
61A-45376-00-94	REC61A-45376-00-94	341-385
61A-45501-20	REC61A-45501-20	385
61A-45501-30	REC61A-45501-30	385
61A-45527-00	REC61A-45527-00	325-329-333-377-381-385
61A-45538-00	REC61A-45538-00	377-381-385
61A-45567-00	REC61A-45567-00/60-0	331-337
61A-45577-00	REC61A-45577-00/60-0	331-337
61A-45587-00	REC61A-45587-00/60-0	333-339
61A-45587-00/60	REC61A-45587-00/60-0	385
61A-45631-03	REC61A-45631-03	383
61A-45632-00	REC61A-45632-00	331-337-383
61A-45633-00	REC61A-45633-00	331-337-383-392
61A-45634-01	REC61A-45634-01	331-337-341-383
61A-45635-00	REC61A-45635-00	331-335-337-341-383
61A-45641-02	REC61A-45641-02	331-337-383
61A-81800-01	PH130-0059	110
61A-81800-01	PH130-0059	110
61A-81941-00	REC61A-81941-00	110-114
61A-81950-00	REC61A-81950-01	115
61A-81950-01	REC61A-81950-01	115

R.O. / OEM	REF	
61A-81960-00	REC61A-81960-04	117
61A-81960-01	REC61A-81960-04	117
61A-81960-02	REC61A-81960-04	117
61A-81960-03	REC61A-81960-04	117
61A-81960-04	REC61A-81960-04	117
61A-85885-00	REC6X2-85885-10	103
61A-W0001-A1	REC61A-W0001-01	252-254
61A-W0078-01	REC61A-W0078-A1	153
61A-W0078-A1	REC61A-W0078-A1	328-383
61A-W0078-A3	REC61A-W0078-A1	71-72-155-157-333
61A-W0093-01	REC61A-W0093-01	97
61B-82510-01	REC61B-82510-02	113
61H-81800-00	PH130-0051	110
61H-81800-01	PH130-0051	110
61N-11181-A1	REC61N-11181-00	229
61N-11181-A2	REC61N-11181-00	248-254
61N-11515-00	REC61N-11515-00	229
61N-11603-00	REC61N-11603-00	229-263-266
61N-11604-00	REC61N-11604-00	229-263
61N-11605-00	REC61N-11605-00	229-263
61N-11631-00-95	REC61N-11631-00K	229-263-266
61N-11635-00	REC61N-11635-00K	229-263
61N-11636-00	REC61N-11636-00K	229-263
61N-14198-00	REC61N-14198-00	274
61N-14301-04	REC61N-14301-04	91-93
61N-24521-00	PAF15-07080002	80
61N-24560-00	PAF15-07080000	80
61N-24563-00	REC61N-24563-10	80
61N-24563-10	REC61N-24563-10	65-66-68-69-80-81-82
61N-26311-00	REC61N-26311-00	129
61N-44146-00	REC61N-44146-00	361
61N-44311-01	PAF25-04050000	297
61N-44311-01	PAF25-04050001	148-154-155-297-355
61N-44322-01	REC61N-44322-00	154-155-297-355
61N-44323-00	REC61N-44323-00	149-154-155-297-355
61N-44362-10	PAF25-04000017S	297-355
61N-44362-10	PAF25-04000017	297-355
61N-45127-00	PAF25-04000013	297-355
61N-45214-00	PAF25-04000021	295
61N-45251-00	PAF15-06000004	295
61N-45251-01	CM61N-45251-01	160-169-291-351-355
61N-45251-01	CM61N-45251-01A	65-66-160-169
61N-45251-01	TEN01135	163-169
61N-45251-01	TEN01135AL	163-169
61N-45311-02-4D	PAF25-04000001	295
61N-45315-00	PAF25-04000009	297-355
61N-45361-01-4D	PAF25-04070001	295-355
61N-45361-01-8D	PAF25-04070000	295-388-389
61N-45371-00	TEN01130	165-355
61N-45510-00	PAF25-04010000S	297
61N-45510-00	REC61N-45510-00	355-388-389
61N-45510-10	PAF25-04010000L	297
61N-45510-10	REC61N-45510-10	355-388-389
61N-45536-00	PAF25-04000002	297-355
61N-45551-00	PAF25-04000005	295
61N-45551-00	REC61N-4555	

R.O. / OEM	REF		R.O. / OEM	REF		R.O. / OEM	REF	
61N-45560-10	REC61N-45560-10	355-388-389	633-11634-00	REC663-11634-00	233-263	63P-43880-11	REC63P-43880-22	124
61N-45571-00	PAF25-04070004	295	633-85518-00	REC663-85518-00	132	63P-43880-12	REC63P-43880-22	124
61N-45571-00	REC61N-45570-00	355-388-389	634-11633-00	PAF15-07020006	183-219	63P-43880-22	REC63P-43880-22	124
61N-45587-00-10	PAF25-04000003-2	297	634-11633-00	REC634-11633-00	227-260-262	63P-45300-00-8D	REC416-B20F	278
61N-45587-00-11	PAF25-04000003-3	297	63AH-61350-00	PAF20-07000100W	130	63P-45300-02-8D	REC416-B20F	327
61N-45587-00-12	PAF25-04000003-4	297	63D-11181-A2	REC63D-11181-A1	237-248-254	63P-45300-10-8D	REC416-B25F	278
61N-45587-00-13	PAF25-04000003-5	297	63D-11193-A0	REC63D-11193-A0	237-255	63P-45300-12-8D	REC416-B25F	327
61N-45587-00-14	PAF25-04000003-6	297	63D-11603-00	REC63D-11603-00	237-263	63P-45501-00	REC63P-45501-00	329-333
61N-45587-00-15	PAF25-04000003-7	297	63D-11605-00	REC63D-11605-00	237-263	63P-45501-10	REC63P-45501-10	329-333
61N-85540-00	REC61N-85540-00	119	63D-44144-00	PA60-04000004	305-309-313	63P-45551-00	REC63P-45551-00	327
61N-85570-00	REC61N-85570-01	105	63D-44311-00	REC63D-44311-01	148-156-309-313	63P-45987-00	REC6E5-45987-00	323-327
61N-85570-01	REC61N-85570-01	105	63D-44312-00	REC63D-44312-00	301-305-309-313-317-361	63P-46241-00	REC63P-46241-00	211-267
61N-W0001-E1	REC61N-W0001-E1	145-354	63D-44316-00	REC63D-44316-00	301-305-309-313-317-361	63P-81800-00	PH130-0073	112
61N-W0078-10	REC61N-W0078-11	150	63D-44322-00	REC63D-44322-00	301-305-309-313-317-361	63P-81950-00	REC63P-81950-00	115
61N-W0078-11	REC61N-W0078-11	150	63D-44322-00	REC63D-44322-00	301-305-309-313-317-361	63P-81960-00	REC63P-81960-02	116
		65-66-150-154-155-297-354	63D-44323-00	REC63D-44323-00	154-156-301-305-309-313-317-361	63P-81960-01	REC63P-81960-02	116
61N-W0093-00	REC61N-W0093-00	93-96-229	63D-44323-00	REC63D-44323-00	154-156-305-309-313	63P-81960-02	REC63P-81960-02	116
61P2-W0078-00	REC6P2-W0078-00	336	63D-44323-00-00	REC63D-44323-00	149	63P-82380-00	REC63P-82380-00	90-102
61T-11193-A1	REC61T-11193-A0	229-255	63D-44341-00	REC63D-44341-00	301-309-361	63V-11181-A1	REC63V-11181-A1	248
61T-45113-A0	REC61T-45113-A0	253-254	63D-45114-A0	REC63D-45114-A0	272	63V-11181-A2	REC63V-11181-A1	227-254
61T-W0001-02	REC61T-W0001-02	229-250-254-266-267	63D-45123-00	REC63D-45123-00	269	63V-11412-00	REC63V-11412-00	227-256
624-14485-00	PAT15-04010202	235	63D-45214-00	PAT40-04000022	299-303-307-311	63V-11422-00	REC63V-11422-00	227-256
624-14485-00	REC624-14485-00	221-225-227-231-233-237-239-241-243	63D-45215-00	PAT40-04000023	299-303-307-311	63V-11432-00	REC63V-11432-00	227-256
624-24634-00	PAF4-04120103	75	63D-45251-00	TEN01131	165-169	63V-11442-00	REC63V-11442-00	227-256
626-14390-90	REC626-14390-90	98	63D-45251-01	CM63D-45251-01	159-169	63V-11445-00	REC63V-11445-00	227
626-44365-01	REC626-44365-01	349-353	63D-45251-01	TEN01131	165	63V-11515-02	REC63V-11515-02	227
626-45316-09	REC626-45316-09	291-292-349	63D-45251-10	TEN01132	163-169	63V-14126-00	REC63V-14126-00	94
626-45577-00	PAF15-06080006-1	293-351	63D-45321-00	PAF60-04000101	305-309-313	63V-14301-00	REC63V-14301-00	93
626-45577-00-01	PAF15-06080006-1	291-349	63D-45344-00	PAF60-04000008	313	63V-14984-00	REC63V-14984-00	94
626-45577-00-03	PAF15-06080006-2	349	63D-45361-02-4D	REC63D-45361-02-4D	299-307-361	63V-14985-00	REC63V-14985-00	93-100
626-45577-00-05	PAF15-06080006-5	349	63D-45361-02-8D	PAF60-04030000	307-311	63V-15396-01-CA	REC63V-15396-01-CA	227
626-45577-10	PAF15-06080006-2	293	63D-45361-02-8D	REC63D-45361-02-8D	303-311-389-390	63V-15713-00	PAF15-07130107	112
626-45577-20	PAF15-06080006-3	293	63D-45375-00	PAT40-04000014	301-305-309-313	63V-15714-00	PAF15-07130201	113
626-45577-30	PAF15-06080006-4	293	63D-45375-00	REC688-45375-00	317-321-325	63V-15716-00	PAF15-07130001	113
626-45577-40	PAF15-06080006-5	293	63D-45577-10	PAT40-04060005-2	299-303-307-311	63V-15741-00	PAF15-07130202	112
62P-14984-00	REC6P2-14984-00	72-73-86-88	63D-45577-30	PAT40-04060005-3	299-303-307-311	63V-15767-00	PAF15-07130203	112
62X-43880-00	PH200-T035	122	63D-45577-40	PAT40-04060005-4	299-303-307-311	63V-15784-00	PAF15-07130204	112
62X-43880-01	PH200-T035	122	63D-45577-60	PAT40-04060005-5	299-303-307-311	63V-24411-00	REC63V-24411-00	87
62X-43880-09	PH200-T035	122	63D-45611-00	PAT40-04060005-6	299-303-307-311	63V-41111-00-1S	REC63V-41111-00-1S	227
62Y-11325-00	CM62Y-11325-00	158	63D-45611-00	PAT40-04060005-7	299-303-307-311	63V-41112-A0	REC63V-41112-A0	140-227
62Y-11325-00	CM62Y-11325-00A	65-66-67-68-69-158-197-203-205-207	63D-45635-00	PAF60-04020001	303-307-311	63V-41113-00-1S	REC63V-41113-00-1S	227
62Y-11325-00	PAF25-02010005	191	63D-85540-00	REC63D-85540-04	118	63V-41133-A1	REC63V-41133-A1	268
62Y-11325-00	TEN01149	163	63D-85540-01	REC63D-85540-04	118	63V-43111-00-4D	PAF15-01010100	131
62Y-11372-01	PAF25-05010113	191	63D-85540-02	REC63D-85540-04	118	63V-43111-01-4D	PAF15-01010100	131
62Y-11416-00	PAF25-05010302-1	193-199	63D-85540-03	REC63D-85540-04	118	63V-43112-00-4D	PAF15-01010200	131
62Y-11416-10	PAF25-05010302-2	193-199	63D-85540-04	REC63D-85540-04	118	63V-43112-01-4D	PAF15-01010200	131
62Y-11633-00	PAF25-05020105	193-199-199-201-203-205-207-219	63D-W0001-00	REC63D-W0001-00	237-251-254-68-69-151-154-156-306-310	63V-43131-00	PAF15-01010001	131
62Y-11650-10	PAF25-05020200	199	63D-W0078-01	REC63D-W0078-01	211-215-218	63V-43131-01	PAF15-01010001	131
62Y-11654-00	PAF25-05020204	193-199	63P-11181-00	REC63P-11181-00	161	63V-43131-10	PAF15-01010007	131
62Y-11656-00	PAF25-05020203-1	193-199	63P-11325-00	CM63P-11325-01	161	63V-43145-00	PAF15-01010007	131
62Y-11656-00	PAF25-05020203-2	193	63P-11325-01	CM63P-11325-01A	161	63V-43311-00-4D	PAF15-01010301S	131
62Y-11656-10	PAF25-05020203-2	199	63P-11325-01	CM63P-11325-01A	161-211-214	63V-43311-01-4D	PAF15-01010301S	131
62Y-12116-00	PAF20-05030003	189	63P-11325-11	CM63P-11325-11	161-169	63V-44150-00	PAF15-06030000S	291-351
62Y-12116-00	PAF25-05050003	193-199-199-201-203-207	63P-11325-11A	CM63P-11325-11A	71-73-161-211	63V-44150-10	PAF15-06030000L	291-351
62Y-12121-00	PAF25-05050002	185-189-193-195-199-201-203-205-207	63P-11325-11-00	TEN01164	166-169	63V-44301-00	REC63V-44301-00	289-291-351
62Y-12158-00	PAF15-07040304	185-193-199	63P-11325-21	TEN01165	70-71-211	63V-44301-00-00	REC63V-44301-00	154-155-147
62Y-12159-00	PAF15-07040303	185-193-199	63P-11325-21-00	TEN01165	163	63V-44322-00	REC63V-44322-00	154-155-289-291-293-351
62Y-12216-00	PAF25-05050011	193-199-207	63P-11351-00	REC63P-11351-01	211-218	63V-44323-00-00	REC63V-44323-00	351
62Y-12231-00	PAF25-05050012	193-207	63P-12414-00	REC63P-12414-00	71-138-211	63V-44328-00	REC63V-44323-00	149
62Y-12238-00	PAF25-05050009	193-207	63P-13761-00	REC63P-13761-01	90	63V-44328-01	PAF15-06000014	289-291-351
62Y-12279-00	PAF40-05040003	207	63P-13761-01	REC63P-13761-01	90	63V-44338-00	PAF15-06000014	293
62Y-12414-00	PAF15-07010022	66-67-68-69-138-183-191-195-197-201	63P-13906-00	REC63P-13761-01	89-90	63V-44352-01	REC664-44338-00	351
62Y-12414-00	REC6H3-12414-A1	203-205-207	63P-13907-00	REC63P-13761-01	86	63V-44352-01	CEF500363	143
62Y-12481-10	PAF25-05010113	203-205	63P-13907-01	REC63P-13907-03	86	63V-44362-01	REC63V-44352-01	143-154-155-291-293-351
62Y-14392-00	REC61N-14392-00	93-98	63P-13907-02	REC63P-13907-03	86	63V-44361-01	REC63V-44361-01	351
62Y-14485-00	PAF20-05040005	195	63P-13907-03	REC63P-13907-03	86	63V-44361-11	REC63V-44361-11	351
62Y-14485-00	PAF40-05070002	197-201-203-207	63P-13915-00	REC63P-13915-00	70-71-72-73-82	63V-44365-10	PAF15-02000006	293-350
62Y-15312-00	REC62Y-15312-00	271	63P-14984-00	REC63P-14984-00	71-86-88	63V-45215-00	PAF15-06000002	293-350
62Y-24410-04	PAF25-05130000	85	63P-15312-00	REC63P-15312-00	272	63V-45300-00-4D	REC63V-45300-03-8D	279
62Y-24471-00	PAF25-05130005	87	63P-41114-A3	REC63P-41114-A3	211	63V-45300-03-4D	REC63V-45300-03-8D	279
62Y-41113-00	REC62Y-41133-00	268	63P-4380003	REC63P-43800-20	124	63V-45300-03-8D	REC63V-45300-03-8D	279
62Y-43880-01	PH200-T036	122	63P-4380006	REC63P-43800-20	124	63V-45300-10-4D	REC63V-45300-13-8D	279
62Y-43880-02	PH200-T036	122	63P-4380007	REC63P-43800-20	124	63V-45300-13-4D	REC63V-45300-13-8D	279
62Y-44151-00	PAF60-04000003	303-307-311	63P-438002D	REC63P-43800-20	124	63V-45300-13-8D	REC63V-45300-13-8D	279
62Y-44555-00	REC670-44555-00-94	135	63P-43811-10	REC48630-92J00	125	63V-45311-01-4D	PAF15-06000001	351
62Y-45127-00	REC62Y-45127-00	268	63P-43811-20	REC48630-92J00	125	63V-45315-A0	REC63V-45315-A0	291-351
62Y-45571-00	PAF60-04000500	311	63P-43880-03-00	REC18-6865	124	63V-45331-00-5B	REC63V-45331-00-5B	291-351
62Y-45631-00	PAF60-04020003	307-311	63P-43880-10	REC63P-43880-22	124	63V-45375-00	PAF15-06020005	289-291

R.O. / OEM	REF		R.O. / OEM	REF		R.O. / OEM	REF	
63V-61350-00	PAF15-11020000W	130	64E-43821-05	REC48630-92J00	125	65W-45251-00	TEN01123AL	164-169
63V-85520-00	REC63V-85520-00	106	64E-43821-08	REC48630-96J03	125	65W-45300-00-4D	PAF25-04090000S	295
63V-85533-00	REC63V-85533-00	104	64E-43821-09	REC48630-96J03	125	65W-45300-01-4D	PAF25-04090000L	278
63V-85540-00	REC63V-85540-00-01	118-119	64E-43822-00	REC64E-43822-00	125	65W-45300-01-4D	PAF25-04090000S	278
63V-85540-01	REC63V-85540-00-01	118-119	64E-4384J-00	REC64E-4384J-00	125	65W-45300-10-4D	PAF25-04090000L	295
63V-85540-02	REC63V-85540-00-01	118	64E-43880-02-40	REC18-6865	124	65W-45331-00-5B	PAF25-04000008	297
63V-85570-00	REC63V-85570-00	105	64E-43880-02-40	REC63P-43800-20	124	65W-46241-00	REC65W-46241-00	193-199-267
63V-85580-01	REC63V-85580-01	107	64J-12159-00	PAF15-07040303	189	65W-61350-00	PAF25-07000300W	130
63V-W0001-00	REC63V-W0001-00	226	64J-24560-00	REC64J-24560-10	80	65W-81800-00	PH130-0029	111
63V-W0001-01	REC63V-W0001-00	249-254	64J-24560-10	REC64J-24560-10	80	65W-81800-01	PH130-0029	111
63V-W0001-21	REC63V-W0001-21	144	64J-W0001-20	REC64J-W0001-20	145	65W-81800-02	PH130-0029	111
63V-W0078-00	REC63V-W0078-01	150	64J-W0001-21	REC64J-W0001-21	146-333	65W-81800-03	PH130-0029	111
63V-W0078-01	REC63V-W0078-01	65-154-155-290-350	64K-45300-02-NA	REC416-B20	281	65W-81941-00	PH375-0034	111-114
63V-W0093-00	REC63V-W0093-00	93-95-226	64P-45300-10-8D	REC418-A25	280	65W-81941-00	PH375-0036	110
63V-W4311-00-4D	PAF15-01010200	131	64P-45300-10-8D	REC418-B25F	278	65W-82504-00	PAF15-07010103	103
63V-W4311-03-4D	PAF15-01010200	131	64P-45300-12-8D	REC418-B25F	327	65W-82575-01	REC65W-82575-01	120
63V-WS431-B6-8D	PAF15-01010200	131	650-11370-00	REC650-11370-00	231	65W-8510-10	PAF25-05140000	121
63W-13610-00	REC63W-13610-00	92-99	650-11370-01	REC650-11370-00	225-235-237-239-241-243	65W-85550-01	PAF25-05150000	109
646-11633-00	REC646-11633-00	220	650-11651-00	REC650-11651-04	227-260	65W-85570-01	PAF25-05120000	104
646-11651-00	REC646-11651-00	260-261	650-14385-00	REC650-11651-01	100	65W-85580-00	PAF25-05110000	107
646-11651-02	REC646-11651-02	220-260	650-14485-03	REC650-14485-03	227	65W-85790-00	PAF25-0510201	103
646-11681-00	REC646-11681-00	220-260	650-24351-00	REC650-24351-51	75	65W-W0001-00	REC65W-W0001-00	217
646-14623-A1	REC646-14623-A1	220-254-270	650-24351-01	REC650-24351-51	75	65W-W0001-02	REC65W-W0001-00	190-
646-24251-01	PAF4-05000300	80	650-24351-50	REC650-24351-51	75	65W-W0001-02	REC65W-W0001-00	218
646-24251-01	REC35-80365M	80	650-24351-51	REC650-24351-51	75	65W-W0001-20	REC65W-W0001-20	145-297
646-24251-02	PAF4-05000300	64-80-81				65W-W0093-02	REC8542561	95-190-197
646-24251-02	REC35-80365M	80-82-83	650-24378-00	PAF4-04010102	173-175-177-179-180-235-237-241	661-41262-01	PAF15-07000016	100
646-44322-00	REC646-44322-00	343	650-24431-A0	REC650-24431-A0	88	661-41262-02	PAF15-07000016	100
646-44323-00	REC646-44323-00	343	650-44147-00	REC650-44147-00	134-363-367	662-44352-01	CEF500321	143
646-44323-00	REC646-44323-00	148-155	650-45635-00	REC650-45635-00	291-293-349	662-44352-01	REC662-44352-01	143-347
646-44352-01	CEF500324	143	655-12414-A1	REC655-12414-A1	351	663-11193-A0	REC663-11193-00	239-255
646-44352-01	REC646-44352-01	143-155-343	65E-85570-00	REC63V-85570-00	138-229	663-11411-01	REC663-11411-00	239-256
646-44365-00	REC646-44365-00	343	65F-42537-00	PAF15-01000001	105	663-11561-00	REC663-11561-00	239
646-44366-01	REC646-44366-01	343	65L-13645-00	REC65L-13645-00	105	663-11633-00	REC663-11633-00	239-243-260-261-264
646-45534-00-03	PAF2.6-03000017	343	65L-13646-00	REC65L-13646-00	133	663-11634-00	REC663-11634-00	235-263
646-45551-00	REC646-45551-00	343-387	65L-13761-00	REC65L-13761-00	275	663-12414-A0	REC663-12414-00	138-239
646-45560-00	REC646-45560-00	343-387	65L-13907-00	REC65L-13907-00	275	663-12416-00	REC663-12416-00	235-239
647-11610-00	REC647-11610-00	225-262-266	65L-24563-00	REC65L-24563-00	89-90	663-13621-A0	REC663-13621-00	275
647-11610-10	REC647-11610-10	225	65N-45321-00	REC65N-45321-00	71-72-81-82	663-14198-A0	REC663-14198-00	275
647-11610-20	REC647-11610-20	225	65N-W0078-A1	REC65N-W0078-A1	335	663-14483-A0	REC663-14483-A0	275
647-14323-00	REC647-14323-00	98	65W-08M87	PAGB/T5782-M8X35	152-157	663-14548-00	REC663-14548-00	99
647-14323-00	REC6G1-14985-00	93-100	65W-11111-02-94	PAF25-05050100	191	663-14923-00	REC663-14923-00	99
647-14385-00	REC647-14385-00	100	65W-11119-00	PAF25-05010106	191	663-24411-00	REC663-24411-00	87
647-14386-10	REC647-14386-10	99	65W-11168-00	PAF25-05010103	191	663-41114-A0	REC663-41114-00	142-239
647-44366-00	REC647-44366-00	154-155-291-346-347-351	65W-11169-00	PAF25-05010108	191	663-42138-00	REC663-42138-00	130
647-45316-09	REC647-45316-09	347	65W-11181-30	PAF25-05040000	191-215-218	663-43118-01-4D	REC663-43118-01-4D	134
647-45551-00	REC647-45551-00	347-387	65W-11191-00-94	PAF25-05000005	191	663-44144-01	REC663-44144-01	369-371
647-45560-00	REC647-45560-00	347-387	65W-11351-10	PAF25-00000013	191	663-44151-00	REC663-44151-00	369-371
647-45570-01	REC647-45570-00	347-387	65W-11356-00	PAF25-05000004	217-218	663-44311-02	REC663-44311-02	155-156-359-369
647-45943-00-EL	SOL3011-090-07-P	402	65W-11411-01	PAF25-05020001	191	663-44311-02-00	REC663-44311-02	147
648-11633-00	REC648-11633-00	237-260-261-263-264	65W-11476-00	PAF25-05000022	193-219	663-44315-A0	REC663-44315-A0	155-156-357-359-369
648-13621-A1	REC648-13621-A0	273	65W-11536-10	PAF25-05000022	193-199	663-44316-A0	REC663-44316-A0	357-359-369
648-13645-A0	REC648-13645-A0	273	65W-11537-01	PAF25-05000021	193-199	663-44322-00	REC663-44322-00	154-155-156-357-359-369
648-14198-A0	REC648-14198-A0	274	65W-11631-00-96	PAF25-05050017	193	663-44322-00	REC663-44322-00	149-155-156-357-359-369
648-14384-01	REC648-14384-01-00	94	65W-11631-00-96	PAF25-05020100	193-199-219	663-44323-00	REC663-44323-00	149-155-156-357-359-369
648-14385-00	REC648-14385-00	100	65W-11642-11	PAF25-05020101	193-199	663-44324-A0	REC663-44324-A0	357-359-369
648-24411-00	REC648-24411-00	87	65W-11665-00	PAF25-05020310	193	663-44341-00	REC663-44341-00	369
648-24434-01	REC648-24434-01	88	65W-12146-00	PAF25-05050008	193			154-155-156-301-305-309-313-317-321-333-357-359-361-363-367-369-371-373-385
648-24435-02	REC648-24435-02	88	65W-12151-00	PAF25-05050300	193			
648-44146-00	REC648-44146-00	134	65W-12151-00	PAF25-05050301	193-199	663-44366-00	REC663-44366-00	155-156-357-359-369
648-45633-00	REC648-45633-00	291-295-349-351-353-355-357	65W-12171-10	PAF25-05050200	193			
648-45633-11	PAF25-04060000	295	65W-12228-00	PAGB/T5783-M6X20	191			
648-45633-11	REC648-45633-00	293-387-388-389	65W-13286-00	PAF25-05010107	191			
648-45635-00	REC648-45635-00	295-353-355	65W-13300-00	PAF25-05050400	193	663-44367-00	PAT40-02000002	301-305-309-313-317-321-367-371
64D-11603-01	REC64D-11603-01	245	65W-14457-10	PAF25-05080004	268			
64D-11603-02	REC64D-11603-01	247-265	65W-14901-12	PAF25-05070000	91	663-44551-02-8D	REC663-44551-02-8D	135
64D-11603-02	REC64D-11603-01	266-267	65W-15100-00-94	PAF25-05010000	191	663-45123-00	REC663-45123-00	268
64D-11603-04	REC64D-11604-01	265	65W-15121-00	PAF25-05000007	191	663-45331-00-94	REC663-45331-00-94	369-390
64D-11603-05	REC64D-11605-01	265	65W-15663-00	PAGBT3452-1-97.5X1.8	191	663-45375-00	REC663-45375-00	367
64D-11604-01	REC64D-11604-01	245-247	65W-24251-00	REC40145	82	663-45376-00	REC663-45376-00	305-325-335-367
64D-11604-02	REC64D-11604-01	247	65W-24251-10	REC40145	80			
64D-11605-01	REC64D-11605-01	245	65W-41113-01-94	PAF25-05010112	191	663-45376-00-94	REC663-45376-00	301-309-313-317-321-329
64D-11605-02	REC64D-11605-01	247	65W-41114-00	PAF25-05010111	141-191	663-45510-01	REC663-45510-01	369-390
64D-11631-02-90	REC64D-11631-00K	247-265-267	65W-42138-00	PAF15-01030100	131	663-45552-00	REC663-45552-00	359-365-369
64D-11642-02-90	REC64D-11642-00K	247-265-267	65W-43800-00-4D	PAT40-10000000	124	663-45557-00	REC663-45576-00	365
64D-14384-01	REC64D-14384-1	94	65W-43800-01-4D	PAT40-10000000	124	663-45567-01	PAT40-04000004-1	299-303-307-311
64D-14394-00	REC64D-14394-00	99	65W-43800-02-4D	PAT40-10000000	124	663-45567-01-10	PAT40-04000004-1	365
64D-45300-01-8D	REC416-A20	280	65W-43800-03-4D	PAT40-10000000	124	663-45567-01-12	PAT40-04000004-2	365
64D-45300-02-8D	REC416-A20	379	65W-43800-20-4D	PAT40-10000000	124	663-45567-01-15	PAT40-04000004-3	365
64D-45300-21-8D	REC416-A25	280	65W-43800-21-4D	PAT40-10000000	124	663-45567-01-30	PAT40-04000004-5	365
64D-45300-22-8D	REC416-A25	379	65W-43800-22-8D	PAT40-10000000	124	663-45567-10	PAT40-04000004-2	299-303-307-311
64D-W0093-00	REC64D-W0093-00							



R.O. / OEM	REF		R.O. / OEM	REF		R.O. / OEM	REF	
663-45587-01-18	PAT40-04000003-4	367	66K-13907-00	REC6AW-14984-00	86	66T-11604-00	REC66T-11604-00	233-263
663-45587-01-30	PAT40-04000003-5	367	66K-13915-00	REC66K-13915-00	82	66T-11605-00	REC66T-11605-00	233-263
663-45587-01-40	PAT40-04000003-6	367	66K-14984-00	REC66K-14984-00	86-88	66T-11631-01-93	REC66T-11631-01K	233-263-266
663-45587-01-50	PAT40-04000003-7	367	66K-45300-12-NA	REC421-A20	281	66T-11635-01	REC66T-11635-01K	233-263
663-45587-10	PAT40-04000003-2	301-305-309-313	66K-45501-00	REC66K-45501-00	385	66T-11636-01	REC66T-11636-01K	233-263
663-45587-20	PAT40-04000003-3	301-305-309-313	66M-11111-01-1S	PAF15-07040000	185	66T-11681-00	REC66T-11681-00	233-260-261
663-45587-30	PAT40-04000003-4	301-305-309-313	66M-11168-001S	PAF15-07010200	183	66T-14301-60	REC66T-14301-60	92-93
663-45587-40	PAT40-04000003-5	301-305-309-313	66M-11181-10	PAF15-07000100	185-215-218	66T-14384-01	REC66T-14384-01	94
663-45587-50	PAT40-04000003-6	301-305-309-313	66M-11191-00-1S	PAF15-07050001	185	66T-14536-01	REC66T-14536-01	94
663-45587-60	PAT40-04000003-7	301-305-309-313	66M-11325-00	CM15008	159	66T-14992-00	REC66T-14992-00	99
663-45631-01	REC663-45631-00	359-363-365-369-389-390	66M-11325-00	CM15008A	159	66T-15713-00	REC66T-15713-00	112
663-45633-00	REC663-45633-00	359-361-363-365-369-389-390	66M-11325-00	PAF15-07010008	183	66T-26301-00	REC66T-26301-00	129
663-45634-00	REC663-45634-00	303-307-311-359-363-365-369	66M-11327-00-94	TEN01151	163	66T-41114-A0	REC66T-41114-A0	141
663-45941-01-EL	SOL3311-110-17	402	66M-11328-00	PAF15-07010011	168-183-191-197-203-205-207	66T-41133-A0	REC66T-41133-A1	269
663-45943-02-EL	SOL3311-110-15	402	66M-11351-10	PAF15-07010009	65-66-67-68-69-183-191-197-203-205-207	66T-44311-00	PAT40-04000201	148-301-305
663-45945-02-EL	SOL3311-111-13	402	66M-11351-10	PAGB/T97.1-8	183-217	66T-44323-00	REC66T-44323-00	149-154-301-361
663-45945-02-EL	SOL3311-111-13	402	66M-11356-00	PAF15-00000014	193	66T-44514-00-4D	REC66T-44514-00-4D	135
663-45947-02-EL	SOL3311-111-13	402	66M-11356-00	PAF15-00000014	183-217	66T-45113-A0	REC66T-45113-A0	233-253-254
663-45949-01-EL	SOL3311-110-16	402	66M-11356-00	PAF15-00000014	233	66T-45114-A0	REC66T-45114-A0	271
663-45952-02-EL	SOL3311-114-12	402	66M-11357-00	PAF15-00000014	218	66T-45300-10-4D	PAF40-04000000L	279
663-45954-01-EL	SOL3331-119-10	402	66M-11411-00	PAF15-07050002	185	66T-45311-13-8D	PAF40-04000000L	279
663-45956-01-EL	SOL3311-121-09	402	66M-11416-00	PAGB/T97.1-8	191	66T-45321-00	PAT40-04000007	301
663-45958-01-EL	SOL3311-111-14	402	66M-11536-10	PAF15-07010014	183	66T-45344-01	PAT40-04000009	301-305-309
663-45970-60-98	SOL3331-114-12	402	66M-11537-00-94	PAF15-07030000	183-219	66T-45501-01	REC66T-45501-01	361-389
663-45972-60-98	SOL3331-116-11	402	66M-11557-00	PAF15-07030004	185	66T-45501-11	REC66T-45501-10	361-389-390
663-45987-00	REC663-45987-00	365	66M-11631-00-96	PAF15-07030004	185	66T-45551-00	REC66T-45551-00	299-303-361-389-390
663-45987-02	REC663-45987-00	299-303-307-311-359-361-369	66M-11650-00	PAF15-07020001	183-219	66T-45560-01	REC66T-45560-00	299-361-389-390
663-45987-02	REC663-45987-00	405	66M-12111-00	PAF15-07020100	183	66T-45571-00	REC66T-45571-00	299-361-389-390
663-48344-00	REC663-48344-00	127	66M-12113-00	PAF15-07040001	185	66T-45611-00	REC66T-45611-00	299-361-389-390
663-85540-11	REC663-85540-15	119	66M-12116-00	PAF15-07040005	185	66T-45631-00	REC66T-45631-00	299-361-389-390
663-85540-15	REC663-85540-15	119	66M-12121-00	PAF15-07040004	185	66T-45635-00	REC66T-45635-00	299-361
663-W0078-00	REC663-W0078-01	368	66M-12138-60	PAF15-07040002	185	66T-45997-00	REC66T-45997-00	299-361-365-405
663-W0078-01	REC663-W0078-01	152-368	66M-12146-00	PAF15-10030001	185	66T-82575-01	REC66T-82575-01	120
664-11325-00	TEN01166	225	66M-12151-10	PAF15-07040015	185-189	66T-85520-00	REC66T-85520-00	106
664-41114-A0	REC664-41114-A0	140	66M-12170-00	PAF15-07040301	185	66T-85533-00	REC66T-85533-00	104
664-41134-A0	REC664-41134-A0	268	66M-12411-00	PAF15-07040200	185	66T-85540-01	REC66T-85540-00-01	119
664-44338-00	REC664-44338-00	289-291-293-353	66M-12411-01	PAF15-07000031	137	66T-85570-00	REC66T-85570-00	105
664-44338-00	REC664-44338-00	154-155	66M-12535-00	PAF15-07000031	137-179-180-183	66T-85580-00	REC66T-85580-00	107
664-45371-01	CM664-45371-01	357-359-361	66M-13300-10	PAF15-07010012	183-191-197-203-205-207	66T-W0001-01	REC66T-W0001-01	233-250-254
664-45371-01	CM664-45371-01	169	66M-13329-10	PAF15-07040500	185	66T-W0001-20	REC66T-W0001-20	146-361
664-45371-01	TEN01100	164-169	66M-14301-00	PAF15-07040016	185	66T-W0078-00	REC66T-W0078-00	298-361
664-45371-01-00	TEN01100AL	164-169	66M-14301-00	PAF15-07090000	91	66T-W0078-01	REC66T-W0078-01	66-67-152-154
664-45371-01A	CM664-45371-01	353	66M-15100-02-1S	PAF15-07090000W	91	66T-W0093-01	REC66T-W0093-01	93-96-233
664-45371-01A	CM664-45371-01A	66-160-169	66M-24410-11	PAF15-07010000	183	66W-11119-00	PAF25-05010106	191
664-45384-00	REC664-45384-00	353-357	66M-41113-20-1S	PAF15-07010000	183	670-44514-00	REC670-44514-00	135
664-4556-50	PAF15-06000010-7	349	66M-41114-01	PAF15-070140000	85	670-45997-02	REC670-45997-02	359-369
664-45567-01	PAF15-06000010-1	293	66M-41138-00	PAF15-07010019	183	676-11181-A2	REC676-11181-01	249-254
664-45567-05	PAF15-06000010-1	349	66M-41361-00	PAF15-07010018	65-140-183	676-11325-00	TEN01166	166-233-235
664-45567-10	PAF15-06000010-2	293	66M-44361-00	PAF15-04010004	268			173-179-181-183-195-213-225-227-229-231-233
664-45567-12	PAF15-06000010-2	349	66M-44361-10	PAF15-02000005S	291	676-11372-00	PAF15-04000005	233
664-45567-20	PAF15-06000010-3	293	66M-44514-00-4D	PAF15-02000005L	291	676-12414-A0	REC676-12414-A0	233
664-45567-30	PAF15-06000010-4	293	66M-44551-00-4D	PAF15-02010000	135	676-12414-A1	REC676-12414-A0	138
664-45567-40	PAF15-06000010-5	293	66M-44557-00	PAF15-00000001	132	676-13646-A0	REC676-13646-A0	274
664-45567-50	PAF15-06000010-6	293	66M-45113-00	PAF15-00000003	135	676-14186-00	REC676-14186-00	99
664-45631-01	REC664-45631-01	353	66M-45115-00	PAF15-00000005	271	676-14984-00	REC676-14984-00-00	94
664-45631-02	PAF25-04060003	295	66M-45300-02-4D	PAF15-03000003	268	676-14985-01	REC676-14985-01	100
664-45631-02	REC664-45631-00	355-388-389	66M-45300-11-4D	PAF15-06100000S	277-291	676-41112-A0	REC676-41112-A0	142
664-45941-01-EL	SOL3211-099-09	402	66M-46241-00	PAF15-06100000L	277-291	676-41133-A0	REC676-41133-A0	269
664-45945-00-EL	SOL3211-099-10	402	66M-46297-00	CM66M-45371-00	159-169-291	676-41360-00	REC676-41360-02	132
664-45947-01-EL	PAF25-04080000	295	66M-46371-00	TEN01136	65-164-169	676-43160-01	REC676-43160-02	132
664-45947-01-EL	SOL3211-099-11	402	66M-46421-00	REC66M-46241-00	185-267	676-43160-02	REC676-43160-02	132
664-45949-02-EL	SOL3211-099-13	402	66M-81800-00	PAF15-07000024	185	676-44311-00	REC676-44311-00	148-156-363-367
664-45954-00-EL	SOL3211-099-12	402	66M-81800-01	PH130-0084	110	676-44315-A0	REC676-44315-00	367
664-45970-00-98	SOL3231-103-12	402	66M-81800-02	PH130-0034	111	676-44315-A1	REC676-44315-00	156-363
664-45972-00-98	SOL3231-105-11	402	66M-81800-02	PH130-0084	110	676-44316-A1	REC676-44316-A1	363
664-45987-00	REC664-45987-00	353	66M-85520-00	PH130-0084	110	676-44322-00	REC676-44322-00	156-367
664-81970-60	REC6G1-81970-62	116	66M-85533-00	PAF15-07000300	106	676-44323-00	REC676-44323-00-40	149-156-367-363
664-81970-61	REC6G1-81970-62	116	66M-85540-10	PAF15-07000400	104	676-44324-A0	REC676-44324-A0	367
664-81970-62	REC6G1-81970-62	116	66M-85550-00	PAF15-07000500	118	676-44324-A1	REC676-44324-A0	363
664-81970-63	REC6G1-81970-62	116	66M-85550-10	PAF15-07070000	109	676-44341-94	REC676-44341-00	363
665L-13915-00	REC65L-13915-00	82	66M-85570-00	PAF15-07070100W	109	676-44361-00	REC676-44361-00	367
667-41114-A0	REC66T-41114-A0	233	66M-85570-00	PAF15-07000600	104	676-44361-10	REC676-44361-10	367
667-45551-00	REC66T-45551-00	303	66M-85580-00	REC689-81311-40	105	676-44518-00	REC676-44518-00	135
667-45571-00	REC66T-45571-00	303	66M-85580-01	PAF15-07000200	107	676-45114-A1	REC676-45114-A1	271
667-45997-00	REC66T-45997-00	303-307-311	66M-W0001-01	REC66M-W0001-01	182-216-218	676-45127-00	REC676-45127-00	269
6689-W0001-C2	REC689-W0001-C2	145	66M-W0001-20	REC66M-W0001-20	144-290	676-45128-00	REC676-45128-00	269
66G1-81941-10	REC89-825096T01	114	66M-W0093-01	REC66M-W0093-01	95-182	676-45251-00	TEN01109	163-169
66K-13907-00	REC66K-13907-00	86	66M-W009B-15-1S	PAF15-07000000	185	676-45251-00	TEN01127	166-233-235
			66N-11603-00	REC66N-11603-00	183-219	676-45314-00	REC676-45314-00	363
			66T-11181-A0	REC66T-11181-00	249	676-45361-01-94	REC676-45361-00	363-390
			66T-11181-A2	REC66T-11181-00	233-254	676-45501-		

R.O. / OEM	REF		R.O. / OEM	REF		R.O. / OEM	REF	
676-81800-10	PH130-0007	111	67D-12121-00	PA166F-010002	173	682-11610-01	REC682-11610-01	227-266
676-81970-00	REC6G1-81970-62	116	67D-12121-00	PAF4-04080006	175-180	682-11610-11	REC682-11610-11	227-262
677-11181-A1	REC677-11181-A0	225-248-254	67D-12151-00	PA166F-010009	173-175-179	682-11610-21	REC682-11610-21	227-262
677-11412-02	REC677-11412-02	225-256	67D-12154-00	PAF4-04000015	175	682-11681-00	REC682-11681-00	227-260
677-11422-02	REC677-11422-02	225-256	67D-12157-00	PA166F-010008	173-175-179	682-12413-00-1S	REC682-12413-00-1S	139-227
677-11432-02	REC677-11432-02	225-256	67D-12413-00-1S	PAF4-04070001	175	682-12413-00-9M	REC682-12413-00-9M	139
677-11442-02	REC677-11442-02	225-256	67D-14301-03	PAF4-04140000	91	682-12414-A1	REC682-12414-A1	138-139-227
677-11631-00-97	REC677-11631-00K	225-262-266	67D-24410-03	PAF4-04090000	85	682-13621-A0	REC682-13621-00	273
677-11635-00	REC677-11635-00K	225-262	67D-24610-00	PAF4-04120100	75	682-41112-A1	REC682-41112-00	140
677-11636-00	REC677-11636-00K	225-262	67D-24610-02	PAF4-04120100	75	682-41114-A1	REC682-41114-00	140
677-11650-01	REC677-11651-00	260	67D-24610-03	PAF4-04120100	75	682-41133-A0	REC682-41133-A0	268
677-13621-A1	REC677-13621-00	273	67D-24610-04	PAF4-04120100	75	682-41237-50	REC682-41237-50	132
677-14198-A1	REC677-14198-A1	273	67D-44366-00	PAF4-03000021	285-287	682-42137-00	REC682-42137-00	132
677-14227-01	REC677-14227-00	94	67D-45113-A0	PAF4-00000006	175-217-218	682-44147-00	REC682-44147-00	349-357
677-14343-68	REC677-14343-68	98	67D-45560-00	PAF4-03010000	285-287-387	682-44176-00	REC682-44176-00	349
677-14384-01	REC677-14384-01	94	67D-45570-00	PAF4-03040000	285-287-387	682-44312-00	REC682-44312-00	349
677-24434-02	REC677-24434-02	273	67D-45631-01	PAF4-03030002	285-287	682-44315-00	REC682-44315-00	154-155-156-349
677-24435-01	REC677-24435-01	87	67D-45635-00	PAF4-03000008	285-287	682-44322-00	REC682-44322-00	154-155-156-349
677-24471-01	REC677-24471-01	87	67D-85640-00	PAF4-04000038	106	682-44323-00	REC682-44323-00	154-155-156-349
677-26301-02	REC677-26301-02	129	67D-W0093-00	REC67D-W0093-00	95-177	682-44328-00	REC682-44328-00	349
677-41112-A1	REC677-41112-A0	225	67F-11181-02	REC67F-11181-03	215-218	682-44352-00	REC682-44352-01	349
677-41114-A0	REC677-41114-A0	140	67F-11181-03	REC67F-11181-03	215-218	682-44352-03	CEF500320	143
677-41114-A1	REC677-41112-A0	225-389	67F-11325-00	CM67F-11325-01	159	682-44352-03	REC682-44352-01	154-155-156
677-45113-A0	REC677-45113-A0	225-252-254	67F-11325-01	TEN01146	163	682-44352-03	REC682-44352-01	349
677-45251-00	CM43107M	169	67F-11325-01	CM67F-11325-01	161	682-44361-01	REC682-44361-10	349
677-45251-00	CM6E0-45251-11	347	67F-11325-01	CM67F-11325-01A	70-71-72-73-161-211-213	682-44361-10	REC682-44361-10	154-155-156-349
677-W0093-00	REC677-W0093-00	95-225	67F-11325-01	TEN01146-1	163	682-44361-10	REC682-44361-10	154-155-156-349
679-14923-00	REC679-14923-00	99	67F-11328-00	REC67F-11328-00	209-211-214	682-44365-00	REC682-44365-00	154-155-156-349
679-14966-00	REC679-14966-00	100	67F-12411-00	REC67F-12411-01	137	682-44514-01-94	REC682-44514-01-94	135
679-44150-00	REC679-44150-00	367	67F-12411-01	REC67F-12411-01	69-70-71-72-73-137-209-211-213	682-44555-30	PAF15-00000002	135
679-44150-10	REC679-44150-10	367	67F-14371-01	REC67F-14371-01	101	682-45113-02	REC682-45113-A0	254-271
679-44152-00	REC679-44152-00	367	67F-24251-02	REC40165	80-81-82	682-45251-00	TEN01128	166
679-44316-A0	REC679-44316-A0	367	67F-41134-A0	REC67F-41134-A0	269	682-45376-01	REC682-45376-01	349
679-44341-00-94	REC679-44341-00	367	67F-41138-00	REC67F-41138-00	269	682-45631-00	REC682-45631-00	291-293-349-351-387-388
679-44514-00-94	REC679-44514-00-94	135	67F-4380R-00	REC48630-94900	125	682-81800-10	PH130-0061	110
679-45251-00	CM679-45251-00	160	67F-4380R-01	REC48630-94900	125	682-81800-11	PH130-0061	110
679-45251-00A	CM679-45251-00A	160	67F-43811-02	REC48630-94900	125	682-81800-12	PH130-0061	110
679-45315-A1	REC679-45315-A1	365	67F-43880-00	PH200-T044	123	682-82556-00	PAF4-01090401	120
679-45321-02	REC679-45321-02	365	67F-44311-00	REC67F-44311-01	321	682-W0078-A1	REC682-W0078-A1	150-154-155-156-348
679-45331-00-94	REC679-45331-00	365	67F-44311-01-00	REC67F-44311-01	148-154-155	683-44361-01	REC683-44361-01	349
679-45371-00	TEN01101	164-169-365-369	67F-44322-00	REC67F-44322-00	321-154-155	683-44365-01	REC683-44365-01	349
679-45371-00	TEN01101AL	164-169	67F-44323-00	REC67F-44323-00	149-154-155-321	683-44373-00	REC683-44373-00	349
679-45501-10	REC679-45501-10	367-389	67F-44352-00	CEF500364	143	683-45315-00	REC683-45315-A0	349
679-45536-00	REC679-45536-00	367	67F-44352-00	REC67F-44352-00	143-321-154-155	683-45361-00-EJ	REC683-45361-01-4D	349
679-45560-00	REC679-45560-00	365-389	67F-45113-00	REC67F-45113-00	272	683-45361-02-4D	REC683-45361-01-4D	291-351
679-45571-00	REC679-45571-00	365	67F-45123-00	REC67F-45123-00	269	683-45361-02-8D	PAF15-06080000	293
679-45611-01	REC679-45611-00	359-365-389-390	67F-45127-00	REC67F-45127-00	269	683-45361-02-8D	REC683-45361-01-4D	293
679-W0078-00	REC679-W0078-A1	151-156	67F-45331-00-94	REC67F-45331-00-CA	319	683-45361-02-8D	REC683-45361-02-4D	387-388
67C-11181-01	REC67C-11181-01	197-215-218	67F-45371-00	CM67F-45371-00	70-161	683-45611-00	REC683-45611-00	291-293-349-351-387-388
67C-11351-01	REC67C-11351-01	197-207-218	67F-45371-00A	CM67F-45371-00A	68-69-161-315-319	683-45941-00-00	SOL3111-093-12	402
67C-11356-00	REC67C-11356-00	197	67F-45371-00	TEN01140	165	683-45942-00-EL	SOL3111-093-10	402
67C-11537-01	PAF40-05040006	199	67F-45371-00	TEN01141	165-169	683-45943-00-EL	SOL3111-093-11	402
67C-11603-00	REC67C-11603-00	193-195-199-201-203-205-219	67F-45371-00	TEN01141AL	165-169	683-45945-00-EL	SOL3111-093-09	402
67C-11650-00	PAF25-05020200	193	67F-45371-00	REC67F-45501-10	321-391	683-45947-00-EL	SOL3111-093-08	402
67C-12111-00	PAF25-05050001	193-199	67F-45501-10	REC67F-45501-10	319-390-391	683-W0001-21	REC683-W0001-21	348
67C-15312-00	PAF25-02010007	271	67F-45560-00	REC67F-45560-00	391	683-W0001-C1	REC683-W0001-21	144
67C-15312-00	REC67C-15312-00	271	67F-45570-00	REC67F-45570-00	391	688-11111-02-1S	REC688-11111-02-1S	243
67C-41114-00	REC67C-41114-00	141	67F-45576-00	REC67F-45576-00	315-319	688-11181-A1	REC688-11181-A1	243
67C-41114-10	REC67C-41114-00	197	67F-45611-01	REC67F-45611-01	315-319-391	688-11181-A2	REC688-11181-A1	249
67C-41133-00	REC67C-41133-00	268	67F-45997-00	REC67F-45997-00	315-319-371-405	688-11181-A2	REC688-11181-A1	254
67C-43880-00	REC67C-43880-01	122	67F-46241-00	REC67F-46241-00	209-267	688-11193-A1	REC688-11193-A1	243-255
67C-43880-01	REC67C-43880-01	122	67F-81800-01	PH130-0055	112	688-11325-00	CM85007	160
67C-45113-00	REC67C-45113-00	271	67F-81800-02	PH130-0055	112	688-11325-00	CM85007A	160
67C-45123-00	REC67C-45123-00	268	67F-81800-03	PH130-0055	112	688-11370-01	TEN01147	163-237-243
67C-45251-00	CM67C-45251-00A	158-169-361-66-67-69-158-299-303-307-311	67F-81800-04	PH130-0055	112	688-11411-01	REC688-11411-00	243-256
67C-45251-00	TEN01132	163	67F-81960-00	REC67F-81960-12	116	688-11603-A0	REC688-11603-A0	239-243-264-266
67C-45371-00	CM67C-45371-00	160-169	67F-85570-00	REC67F-85570-00	105	688-11605-A0	REC688-11605-A0	239-243-264
67C-45371-00	CM67C-45371-00A	66-67-68-69-160-169-299-303-307-311	67F-W0001-00	REC67F-W0001-00	217	688-11610-02	REC688-11610-02	264-266
67C-45501-00	REC67C-45501-00	301-305-389-390	67F-W0001-01	REC67F-W0001-01	209-218	688-11631-02-95	REC688-11631-02K	264-266
67C-45501-10	REC67C-45501-10	301-305-389-390	67F-W0001-20	REC67F-W0001-20	145-318	688-11631-03-94	REC688-11631-03K	239-243-264
67C-45633-00	PAT40-04050005	307-311	67F-W0078-00	REC67F-W0078-00	69-70-152-154-155-318-97-209	688-11631-81-96	REC688-11631-81K	264-266
67C-81800-00	PH130-0028	110	67F-W0093-00	REC67F-W0093-00	209	688-11634-00	REC688-11634-00	229-239-243-263-264
67C-81800-01	PH130-0028	110	67F-11416-10	REC67F-11416-10	209	688-11634-10	REC688-11634-10	241
67C-81800-02	PH130-0028	110	67F-11416-20	REC67F-11416-20	209	688-11635-03	REC688-11635-03K	239-264
67C-W0001-00	REC67C-W0001-01	217	67H-11411-00	REC67H-11411-00	256	688-11635-03	REC688-11635-03K	264
67C-W0001-01	REC67C-W0001-01	197-217	67H-13907-00	REC67H-13907-00	86	688-11636-03	REC688-11636-03K	239
67C-W0001-01	REC67C-W0001-01	218	67H-13907-00	REC67H-13907-00	86	688-11650-03	REC688-11650-03	239-243-264
67C-W0001-20	REC67C-W0001-20	298	67H-43880-00	REC6AW-14984-00	86	688-11650-03	REC688-11650-03	261
67D-11181-A0	PAF4-04000014	175-215-218	67H-8592A-01	REC67H-8592A-01	123	688-11651-00	REC688-11651-00	261
67D-11191-00	PAF4-04000018	175	680-WE090-11-15	PAF4-04000000	175	688-12411-10	REC6E5-12411-30	243
67D-11400-00	PAF4-04030000	175-219	682-11325-00	TEN01162	166-227	688-12413-00-1S	REC688-12413-00-1S	139-243
67D-11650-00	PAF4-04020100	175	682-11351-A0	REC682-11351-A0	253	688-12414-A1	REC688-12414-A1	138-139-243-245-247
67D-11654-00	PAF4-04020103	175	682-11412-00	REC682-11412-00	256	688-12416-00	REC688-12416-00	139-243
67D-12111-00	PA166F-010001	173-180	682-11422-00	REC682-11422-00	256	688-13610-00	REC688-13610-00	99
67D-12111-00	PAF4-04080005	175	682-11432-00	REC682-11432-00	256	688-13621-A1	REC688-13621-A1	274
			682-11442-00	REC682-11442-00	256	688-14198-A2	REC688-14198-A1	274
			682-11610-00	REC682-11610-01	262	688-14416-01		

R.O. / OEM	REF		R.O. / OEM	REF		R.O. / OEM	REF	
688-14483-A0	REC688-14483-A0	274	688-81800-10	PH130-0058	111	68D-G4311-01	PAF4-03000019	147-285
688-14548-00	REC688-14548-00	99	688-81800-11	PH130-0058	111	68D-G4315-A0	PAF4-03000018	285
688-14947-00	REC688-14947-00	98	688-81800-12	PH130-0058	111	68D-G4328-00	PAF4-03000020	285-287
688-24378-00	PAF15-05000011	183-191-195-197-207	688-81950-10	REC688-81950-10	111-114	68D-G4360-00	PAF4-02040001S	285
688-41112-A0	REC688-41112-A0	142-243	688-82560-10	REC688-82560-10	103	68D-G4360-10	PAF4-02040001	285
688-41114-A0	REC688-41114-A0	142-243	688-82575-01	REC688-82575-01	120	68D-G4365-00	PAF4-02040002	283-285
688-41134-A0	REC688-41134-A0	269	688-82586-21	PAF15-13000100W	128	68D-G5251-00	CM6L5-45251-02A	287
688-41211-00	REC688-41211-01	132	688-8258A-10	REC688-8258A	128	68D-G5251-00	PAF4-03000022	64-283-285
688-41211-01	REC688-41211-01	132	688-8258A-20	PAT85-08010100	128	68D-G5300-00-4D	PAF4-03100005	285
688-41217-00	REC688-41217-00	101	688-8258A-30	REC688-8258A-30	128	68D-G5300-10-4D	PAF4-0310000L	285
688-43160-01	REC688-43160-01	132	688-85510-00	REC688-85510-01	121	68D-G5300-11-4D	PAF4-03000001	285
688-43880-11	PH200-T037	123	688-85510-01	REC688-85510-01	121	68D-G5315-A0	PAF4-03000011	285-287
688-44120-11	REC688-44120-12	134	688-85510-10	REC688-85510-10	121	68D-G5321-00	PAF4-03000012	285-287
688-44120-12	REC688-44120-12	134	688-85510-11	REC688-85510-10	121	68D-G5361-00-4D	PAF4-03050001	285-287
688-44120-22	REC688-44120-22	134	688-85540-00	REC688-85540-00	117	68D-G5511-00	PAF4-03000004S	287
688-44311-01	REC688-44311-01	148-156-371	688-85540-16	REC688-85540-16	120	68D-G5511-10	PAF4-03000004L	287
688-44311-01-00	REC688-44311-01	373	688-W0001-02	REC688-W0001-A0	243	68D-G5978-00	PAF4-03000025	283
688-44315-A0	REC688-44315-00	154-155-156-321-371	688-W0001-20	REC688-W0001-20	146	68D-G5987-00	PAF4-03000025	285-287
688-44315-A0-00	REC688-44315-00	373	688-W0001-20-00	REC688-W0001-22	373	68F-11181-00	REC68F-11181-00	249-254
688-44316-A0	REC688-44316-00	321-371	688-W0001-22	REC688-W0001-22	146-370	68F-11193-02	REC68F-11193-02	255
688-44316-A0-00	REC688-44316-00	373	688-W0001-A0	REC688-W0001-A0	251-254	68F-11381-00	REC68F-11381-00	276
688-44322-00	REC688-44322-00	156-371	689-11181-A2	REC689-11181-00	248-254	68F-13440-00	REC68F-13440-00	83
688-44322-00-00	REC688-44322-00	373	689-11325-00	CM3082523	158	68F-13907-01	REC68F-13907-01	86
688-44323-00	REC688-44323-00	156-371	689-11325-00	CM689-11325-00A	158	68F-13915-00	REC68F-13915-00	82
688-44323-00-00	REC688-44323-00	149-373	689-11610-01	TEN01121	167-229	68F-24563-00	REC68F-24563-00	81
688-44324-A0	REC688-44324-00	321-371	689-11610-01	REC689-11610-00	263-266	68F-24563-10	REC68F-24563-10	81
688-44324-A0-00	REC688-44324-00	373	689-11631-00-95	REC689-11631-00K	263-266	68F-41114-00	REC68F-41114-00	142
688-44341-01-94	REC688-44341-01	371-373	689-11633-00	REC689-11633-00	229-260-263	68F-45113-01	REC68F-45113-01	253-254
688-44352-03	CEF500323	143	689-11651-00	REC689-11651-00	229-260-261	68F-81800-00	PH130-0056	111
688-44352-03	REC688-44352-03	143-156-371	689-11681-01	REC689-11681-00	229-260-261	68F-81800-01	PH130-0056	111
688-44352-03-00	REC688-44352-03	373	689-15396-01-5B	REC689-15396-01-CA	229	68F-81800-03	PH130-0056	111
688-44361-10	REC688-44361-10	371	689-15755-00	REC689-15755-00	134	68F-8195A-00	REC68F-8195A-00	115
688-44514-00	REC688-44514-00	135	689-41112-A0	REC689-41112-A0	141	68F-83688-00	REC68F-83688-00	90-102
688-44555-00	REC688-44555-00	135	689-41114-A0	REC689-41114-A0	141	68F-83688-10	REC68F-83688-10	90-102
688-45113-A0	REC688-45113-A0	243-253-254	689-44311-03	REC689-44311-00	147-155-353	68F-8592A-00	REC68F-8592A-00	103
688-45114-A1	REC688-45114-A1	272	689-44315-A0	REC689-44315-A0	353	68F-W0001-01	REC68F-W0001-01	252-254
688-45123-00	REC688-45123-00	269	689-44316-A0	REC689-44316-A0	353	68N-81940-00	PH375-0042	114
688-45214-02	REC688-45214-02	323-365	689-44323-03	REC689-44323-00	155-353	68T-11325-00	CM68T-11325-00	161
688-45215-02	REC688-45215-02	323-365	689-44324-A0	REC689-44324-A0	155-353	68T-11325-00A	CM68T-11325-00A	71-72-73-161-211
688-45251-01	CM688-45251-01	158-169	689-44352-02	CEF500326	143	68T-11325-00	TEN01163	166
688-45251-01	CM688-45251-01A	67-68-69-158-169	689-44352-02	REC689-44352-02	143-155-353	68T-12116-00	PAF4-04800007	175-179-180
688-45251-01	TEN01110	163-169	689-44366-00	REC689-44366-00	155-353-355	68T-13475-00	REC68T-13475-00	271
688-45331-00-94	REC688-45331-00-94	371-373-388-390-391	689-45113-A1	REC689-45113-A0	229	68T-24251-00	REC68T-24251-00	64-65-80-81-82
688-45341-00	REC688-45341-00	295-359-375	689-45501-10	REC689-45501-10	353-388-389	68T-24251-01	REC68T-24251-01	80
688-45341-00-00	REC688-45341-00	373	689-45551-00	REC689-45551-00	353-388-389	68T-24410-00	REC68T-24410-00-00	85
688-45341-10	REC688-45341-00	299-303-307-311-315-319-323-327-331-335-337-341-355-361-363-369-370-379	689-45560-00	REC689-45560-00	353-388-389	68T-24410-01	REC68T-24410-00-00	85
688-45371-02	CM688-45371-02	371	689-45611-00	REC689-45611-00	295-353-355-357-405	68T-44323-00	REC68T-44323-00	149-154-289-293
688-45371-02	CM688-45371-02	160-169	689-81800-10	PH130-0049	110	68T-44352-00	CEF500368	143
688-45371-02	TEN01104	164-169	689-81800-11	PH130-0049	110	68T-44366-00	REC68T-44366-00	143-154-289
688-45371-02	TEN01104AL	164-169	689-81800-12	PH130-0049	110	68T-45251-00	CM68T-45251-00	158-169
688-45371-02-00	CM688-45371-02	373	689-81800-13	PH130-0049	110	68T-45251-00A	CM68T-45251-00A	64-65-158-169-289
688-45375-00	REC688-45375-00	329-371	689-85540-20	REC689-85540-21	119	68T-45251-00	TEN01142	163-169
688-45383-02	REC688-45383-01	315-319-323-371-375	689-85540-21	REC689-85540-21	119	68T-46241-00	REC68T-46241-00	267
688-45383-02-00	REC688-45383-01	373	689-W0001-20	REC689-W0001-20	145	68T-85540-00	REC68T-85540-00	118
688-45384-00	REC688-45384-00	371-375	689-W0001-21	REC689-W0001-21	145-353	68T-W0001-20	REC68T-W0001-20	144-289
688-45384-00-00	REC688-45384-00	373	689-W0078-A6	REC689-W0078-A6	151-155-353	68T-W0078-00	REC68T-W0078-00	150-289
688-45384-02	REC688-45384-00	315-319-323	689-W0093-02	REC689-W0093-02	95	68T-W0078-01	REC68T-W0078-01	64-65-150-154
688-45501-10	REC688-45501-10	390-391	689-W4432-02	REC689-W4432-01	155-156-353	68V-11325-01	CM68V-11325-01	158
688-45501-11	REC688-45501-11	371-390-391	68D-11351-A0	PAF4-04000002	177-270	68V-11325-01A	CM68V-11325-01A	158
688-45536-01	REC688-45536-01	317-321	68D-24610-10	PAF4-04120100	75	68V-11325-01	TEN01156-1	167
688-45551-01	REC688-45551-01	371-390-391	68D-65300-03-4D	PAF4-03100000S	277	68V-11325-01	TEN01156/1AL	167
688-45551-01-00	REC688-45551-00	373	68D-65300-11-4D	PAF4-0310000L	277	68V-11325-02	CM68V-11325-01A	209
688-45560-00	REC688-45560-00	371-390-391	68D-E1111-10-1S	PAF4-04080101	175	68V-11325-02	TEN01156	72-167
688-45560-00-00	REC688-45560-00	373	68D-E1168-00	PAF4-04000010	177	68V-11325-02	TEN01156AL	72-167
688-45567-01	PAT85-040000004-B	315-319	68D-E1169-A0	PAF4-04000009	177	68V-11351-00	REC68V-11351-00	209-218
688-45571-01	REC688-45570-00	371	68D-E1193-A0	PAF4-04000017	175	68V-12111-00	REC68V-12111-00	209
688-45571-01	REC688-45571-00-00	390-391	68D-E1311-02-15	PAF4-04010100	177	68V-13761-00	REC68V-8A360-00	89
688-45587-01	PAT85-040000003-B	317-321	68D-E1325-00	PAF4-04070003	64-65-66-67-68-69-70-71-173-175-179	68V-13761-10	REC68V-13761-10	90
688-45611-00	REC688-45611-00	371-390-391	68D-E1603-00	REC68D-E1603-00	175-219	68V-13907-00	REC68V-13907-00	86
688-45631-01	REC688-45631-00	371-390-391	68D-E1631-00-96	PAF4-04020001	175	68V-13907-01	REC68V-13907-01	86
688-45633-00	REC688-45633-00	373	68D-E1631-00-96	PAF4-04020200	175-219	68V-13907-02	REC68V-13907-02	86
688-45634-00	REC688-45634-00	371	68D-E1633-00	PAF4-04020005	175-219	68V-13907-03	REC68V-13907-03	86
688-45635-00	REC688-45635-00	369-371	68D-E2113-00	PAF4-04020008	173-175	68V-13907-04	REC68V-13907-04	86
688-45930-02-98	SOL3431-133-17	402	68D-E2155-00	PAF4-04080009	175	68V-13915-00	REC68V-13915-00	72-82
688-45970-03-98	SOL3431-130-19	402	68D-E2170-00	PAF4-04040000	175	68V-14984-00	REC68V-14984-00	72-86-88
688-45972-02-98	SOL3431-130-21	402	68D-E2413-00-1S	PAF4-04070000	179	68V-15312-00	REC68V-15312-00	272
688-45978-60-98	SOL3431-135-15	402	68D-E2413-001S	PAF4-04070100	175	68V-24410-00	REC68V-24410-00	85
688-45987-01	REC688-45987-00	315-319-371-405	68D-E2414-A0	PAF4-04070100	175	68V-24563-00	REC68V-24563-00	68-80-81-82
688-45987-01-00	REC688-45987-00	373	68D-E3102-00	PAF4-04000011	64-138-173-175-179	68V-43880-03-40	REC18-6865	124
688-45997-00	REC688-45997-00	383	68D-E5111-00-1S	PAF4-04050100	177	68V-43880-03-40	REC63P-43880-20	124

R.O. / OEM	REF		R.O. / OEM	REF		R.O. / OEM	REF	
68V-W0001-20	REC68V-W0001-20	147-322	69J-45300-22-8D	REC421-B25F	331	6A0-24410-02	REC6A0-24410-04	85
68V-W0078-00	REC68V-W0078-00	70-71-152-155-322	69J-45300-32-8D	REC421-B30F	279	6A0-24410-03	REC692-24410-00	85
68W-43880-03	PH200-T057	123	69J-45361-00-8D	REC69J-45361-00-8D	331-383	6A0-24410-03	REC6A0-24410-04	85
692-14590-00	REC692-14590-01	98	69J-45375-00	REC69J-45375-00	331-383	6A0-24410-04	REC692-24410-00	85
692-14590-01	REC692-14590-01	98	69J-45611-00	REC69J-45611-00	331-337-392	6A0-24410-04	REC6A0-24410-04	85
692-14923-00	REC692-14923-00	98	69J-45631-00	REC69J-45631-00	331-337-392	6A0-24410-05	REC692-24410-00	85
692-24410-00	REC692-24410-00	85	69J-46241-00	REC69J-46241-00	267	6A0-82550-01	REC6A0-82550-01	120
692-24411-00	REC692-24411-00	87	69J-81800-00	PH130-0074	112	6A0-W0001-21	REC6A0-W0001-21	146
692-26301-00	REC692-26301-03	129	69J-81800-01	PH130-0074	112	6A1-14301-03	REC6A1-14301-03	92-93
692-26301-01	REC692-26301-03	129	69J-81960-10	REC69J-81960-13	116	6A1-14613-00	REC6A1-14613-A0	270
692-26301-02	REC692-26301-03	129	69J-81960-11	REC69J-81960-13	116	6A1-14613-01	REC6A1-14613-A0	270
692-26301-03	REC692-26301-03	129	69J-81960-12	REC69J-81960-13	116	6A1-14613-A0	REC6A1-14613-A0	220-270
692-41256-00	REC692-41256-00	101	69J-81960-13	REC69J-81960-13	116	6A1-44325-00P	REC6A1-44325-00	343
692-44120-21	REC692-44120-22	134	69J-85885-00	REC69J-85885-00	90-102	6A1-44361-00	REC6A1-44361-00	343
692-44120-22	REC692-44120-22	134	69J-W0001-20	REC64J-W0001-20	146-333	6A1-85540-01	REC6A1-85540-01	118
692-45300-12-4D	REC692-45300-16-8D	280	69J-W0001-20	REC69J-W0001-20-00	147	6A1-85540-01	REC6A1-85540-01	118
692-45300-13-4D	REC692-45300-16-8D	280	69K-45300-21-8D	REC428-B25F	279	6A1-85570-00	REC6A1-85570-00	105
692-45300-14-4D	REC692-45300-16-8D	280-370	69K-45300-34-8D	REC428-B30F	279	6A1-W0001-22	REC6A1-W0001-22	144
692-W0078-00	REC692-W0078-02	152	69K-45611-00	REC69K-45611-00	331-337	6A1-W0001-23	REC6A1-W0001-23	144-343
692-W0078-00-00	REC692-W0078-02	373	69L-11181-00	REC61A-11181-A0	249-254	6A1-W0078-01	REC6A1-W0078-01	150-155-343
692-W0078-01	REC692-W0078-02	152	69L-11635-00-85	REC69L-11631-00K	267	6A1-W0093-01	REC6A1-W0093-01	93-95
692-W0078-01-00	REC692-W0078-02	373	69L-11642-00-85	REC69L-11642-00	267	6AE-43880-00	PH200-T057	123
692-W0078-02	REC692-W0078-02	152-156-370	69L-45371-00	CM69L-45371-00	160-169	6AE-43880-01	PH200-T057	123
695-11181-A1	REC695-11181-00	248-254	69L-45371-00	CM69L-45371-00A	160-169	6AE-43880-03	PH200-T057	123
695-85540-11	REC695-85540-11	119	69L-45371-00	TEN01145	168-169	6AE-43880-04	PH200-T057	123
695-85540-12	REC695-85540-11	119	69L-81800-00	PH130-0059	110	6AG-11181-00	REC6AG-11181-00	215
695-W0001-01	REC695-W0001-A2	250-254	69M-11181-00	PAF2.6-04000001	173-215-218	6AG-11181-10	REC6AG-11181-00	187-218
696-14590-01	REC696-14590-01	98	69M-11193-A0	PAF2.6-04000005	173	6AH-11111-10-1S	PAF20-05030100	187
696-45113-00	REC696-45113-00	239	69M-11351-A0	PAF2.6-04000004	171-270	6AH-11168-00	PAF20-05040003	187
696-45113-A0	REC696-45113-00	253-254	69M-11400-00	PAF2.6-04000000	173-219	6AH-11169-00	PAF20-05040004	187
696-85540-10	REC696-85540-12	119	69M-11650-00	PAF2.6-04020100	173	6AH-11191-001S	PAF20-05040000	187
696-85540-11	REC696-85540-12	119	69M-12154-00	PAF2.6-04000002	173	6AH-11351-10	REC6AH-11351-10	187-218
696-85540-12	REC696-85540-12	119	69M-12170-01	PAF2.6-04000100	173	6AH-11356-00	PAF20-05040002	187
696-W0093-00	REC696-W0093-00	239	69M-12411-00	REC6AH-12411-00	136	6AH-11372-00	PAF20-05040005	187
696-W0093-01	REC84419M	96	69M-12411-01	REC6AH-12411-01	136-173-175	6AH-11411-00	PAF20-05020004	189-219
696-W0093-02	REC696-W0093-00	96	69M-14301-21	PAF2.6-04000200	91	6AH-11416-00	PAF20-05010003	189
696-W0093-02	REC84419M	96	69M-15361-00	PAF2.6-04010102	171	6AH-11536-00	PAF20-05000027	189
697-11181-A2	REC697-11181-A1	239-249-254	69M-24575-00	PAF2.6-00000004	76	6AH-11537-00	PAF20-05030012	189
697-44352-00	REC6H3-44352-00	369	69M-44361-00	PAF2.6-02000003S	283	6AH-11557-00	PAF20-05000028	189
697-45114-A0	REC697-45114-00	254-271	69M-44361-10	PAF2.6-02000003L	283	6AH-11603-00	PAF20-05020100	189-219
697-45384-00	REC697-45384-00	359-365-369	69M-45113-A0	PAF2.6-00000003	173-217-218	6AH-11631-00	PAF20-05020001	189-219
697-45551-00	REC697-45551-00	369-390	69M-65300-01-4D	PAF2.6-03020000S	277	6AH-11650-10	PAF20-05020200	189
697-45560-00	REC697-45560-00	369-390	69M-65300-11-4D	PAF2.6-03020000L	277	6AH-11654-00	PAF25-05020204	189
697-45571-00	REC697-45570-00	369	69M-85640-00	PAF2.6-04000600	106	6AH-12111-00	PAF20-05030001	189
697-45571-00-00	REC697-45571-00-00	390	69M-E1111-00-1S	PAF2.6-040040100	173	6AH-12121-10	PAF20-05030002	189
697-45611-00	REC697-45611-00	369-388-390	69M-E1191-00-1S	PAF2.6-04000006	173	6AH-12151-00	PAF20-05030301	189
697-81800-10	PH130-0007	111	69M-E1311-00-1	PAF2.6-04010100	171	6AH-12170-00	PAF20-05030200	189
697-81800-11	PH130-0007	111	69M-E1603-01	REC69M-E1603-01	173-219	6AH-12279-00	PAF20-05030008	189
697-81800-12	PH130-0007	111	69M-E1631-01-96	PAF2.6-04020001	173-219	6AH-12411-00	REC6AH-12411-00	65-136-137-187
697-85570-00	REC697-85570-00	105	69M-E1633-00	PAF2.6-04020005	173-219	6AH-12413-00-1S	PAF20-05000700	187
697-85570-11	REC697-85570-10	105	69M-E2155-00	PAF2.6-04040001	173	6AH-12414-00	PAF20-05000702	65-138-187
697-W0001-02	REC697-W0001-02	239	69M-E2413-00-1S	PAF2.6-04000501	173	6AH-12481-00	PAF20-05000116	187
697-W0001-A0	REC697-W0001-02	251-254	69M-E3102-00	PAF2.6-04050100	171	6AH-13300-00	PAF20-05030400	189
698-W0001-21	REC698-W0001-21	145-368	69M-E5111-00-1S	PAF2.6-04050001	171	6AH-13329-00	REC6AH-13329-00	271
69D-45501-10	REC69D-45501-10	390	69M-E5363-00	PAF15-07050004	171-180	6AH-13329-01	PAF20-05030010	189
69D-W0001-20	REC69D-W0001-20	146	69M-E5396-00	PAF2.6-04060001	171	6AH-15100-00	PAF20-05010000	187
69G-45315-A0	PAF20-04000001	292	69M-E5396-00-5B	PAF2.6-04060000	171	6AH-15312-00	REC6AH-15312-00	271
69G-45331-01-CA	PAF20-04010001	292	69M-G2743-00	PAF2.6-04000008	171	6AH-24410-00	PAF20-05050000	85
69G-45510-10	REC69G-45510-10	387	69M-G4311-00	PAF2.6-03000014	147-154-283	6AH-41113-01-1S	PAF20-05000600	187
69G-45510-20	REC69G-45510-20	387	69M-G4323-00	PAF2.6-03000010	148-154-283	6AH-41114-00	PAF20-05000602	187
69G-W0001-20	REC69G-W0001-20	144-289	69M-G4328-00	PAF2.6-03000016	283	6AH-44150-00	PAF20-04020000S	292
69G-W0078-00	REC69G-W0078-01	150	69M-G5300-00-4D	PAF2.6-03020000S	283	6AH-44150-10	PAF20-04020000L	292
69G-W0078-01	REC69G-W0078-01	150	69M-G5300-01-4D	PAF2.6-03020000L	283	6AH-44311-00	PAF20-04040001	147-293
69J-11181-03	REC69J-11181-03	216-218	69M-G5311-00-4D	PAF2.6-03000001	283	6AH-44311-01	PAF20-02000101S	293
69J-11182-03	REC69J-11182-03	216-218	69M-G5315-A0	PAF2.6-03000007	283	6AH-44361-11	PAF20-02000101L	293
69J-11351-11	REC69J-11351-11	213-218	69M-G5321-00-9A	PAF2.6-03000008	283	6AH-44365-00	PAF20-02000007	293
69J-12111-00	REC69J-12111-00	211	69M-G5361-00-4D	PAF2.6-03000300	283	6AH-44368-00	PAF20-02000005	293
69J-12119-00	REC69J-12119-00	211	69M-G5361-00-4D	PAF2.6-03000301	283	6AH-45251-00	TEN01154	169
69J-13440-00	REC35-822626Q15	83	69M-G5511-00	PAF2.6-0300011S	283	6AH-45251-00	TEN01154L	65-165
69J-13440-01	REC35-822626Q15	83-211-213	69M-G5511-10	PAF2.6-0300011L	283	6AH-45300-00-4D	PAF20-04000000S	277
69J-13440-03	REC35-822626Q15	71-72-73-83	69M-G5635-00	PAF2.6-03000200	283	6AH-45300-00-8D	PAF20-04000000L	277-292
69J-13645-A1	REC69J-13645-00	273	69M-WE0090-01-1S	POWERHEAD2.6	173	6AH-45300-10-4D	PAF20-04000000L	277
69J-13761-00	REC69J-13761-00	90	69P-11412-00	REC6G0-11412-00	229-256	6AH-45300-10-8D	PAF20-04000000L	277-292
69J-13906-00	REC69J-13906-00	89-90	69P-11422-00	REC6G0-11422-00	229-256	6AH-45510-00	PAF20-04030000S	293
69J-13907-00	REC69J-13907-03	86	69P-11432-00	REC6G0-11432-00	229-256	6AH-45510-10	PAF20-04030000L	293
69J-13907-01	REC69J-13907-03	86	69P-11442-00	REC6G0-11442-00	229-256	6AH-46241-00	PAF20-05000003	189-267
69J-13907-02	REC69J-13907-03	86	69P-85541-09	REC69P-85541-09	106	6AH-81800-00	PAF20-0500900W	111
69J-13907-03	REC69J-13907-03	86	69W-43880-00	PH200-T036	122	6AH-81800-01	PAF20-0500900W	111
69J-13907-04	REC69J-13907-03	86	69W-43880-01	PH200-T036	122	6AH-81960-00	PAT85-05030300	116
69J-15451-00	REC69J-15451-00	213	69W-45300-00-4D	PAF60-04000000	278	6AH-82560-00	PAT40-05000100	103
69J-15451-A1	REC69J-15451-00	273	69W-45300-00-8D	PAF60-04000000	278	6AH-85510-00	PAF20-05000200	121
69J-24410-00	REC69J-24410-02	86	69W-45300-01-8D	PAF60-04000000	278	6AH-85540-00	PAF20-05000300	118
69J-24410-01	REC69J-24410-02	86	69W-45300-04-8D	PAF60-04000000	311	6AH-855		

R.O. / OEM	REF		R.O. / OEM	REF		R.O. / OEM	REF	
6AW-11182-00	REC6AW-11182-00	214-216-218	6C5-12858-00	PAF15-07010003	187	6E0-45251-11	CM6E0-45251-11	169
6AW-11325-00	TEN01170	214	6C5-13761-00	REC6C5-13761-00	89-90	6E0-45251-11-00	CM6E0-45251-11	158
6AW-11325-00	TEN01170	167	6C5-13907-00	REC866169T01	86	6E0-45251-11-00	CM6E0-45251-11A	65-66-67-68-69-158-169
6AW-11325-00	TEN01170	73-169	6C5-13915-00	REC6C5-13915-00	68-69-70-81	6E0-45251-11-00	TEN01123	164-169
6AW-1132L-00	TEN01173	73-167-169	6C5-14984-00	REC6C5-14984-00	68-69-86-88	6E0-45251-11-00	TEN01123AL	164-169
6AW-1132M-00	TEN01176	167-169	6C5-24251-00	REC6C5-24251-00	67-68-69-70-80	6E0-45315-A0	PAF4-03000011	345
6AW-1132P-00	TEN01177	73-168-169-214	6C5-24410-00	REC6C5-24410-00	85	6E0-45316-09	PAF4-03000003	285-287
6AW-1132R-00	TEN01172	73-167-169-214	6C5-43800-11	PAF60-06000000	124	6E0-45316-09	PAF4-03000016-00	345
6AW-1132T-00	TEN01175	73-167-169	6C5-43800-12	PAF60-06000000	124	6E0-45316-09	REC90340-08002	346
6AW-1132U-00	TEN01174	73-167	6C5-43880-00	PH200-T045	123	6E0-45317-09	PAF4-03000002	285-287
6AW-11351-00	REC6AW-11351-00	214-218	6C5-43880-01	PH200-T045	123	6E0-45317-09	REC6E0-45317-00	345
6AW-12411-00	REC6AW-12411-00	73-137-214	6C5-44361-00	PAF60-02000007	313	6E0-45321-01-5B	PAF4-03000012	345
6AW-13907-00	REC6AW-13907-00	86	6C5-46241-00	REC6C5-46241-00	195-201-203-205-267	6E0-45361-01-4D	PAF4-03050001	345-387
6AW-14613-00	REC6AW-14613-00	272	6C5-81800-00	PH130-0056	111	6E0-45511-01	REC6E0-45511-01	285
6AW-14623-00	REC6AW-14623-00	272	6C5-82105-01	PAT85-05000023	112	6E0-45511-01	REC6E0-45511-01	345-387
6AW-14984-00	REC6AW-14984-00	73-88	6C5-85885-00	REC6C5-85885-00	90-102	6E0-45511-11	PAF4-03000004L	285
6AW-15312-00	REC6AW-15312-00	272	6C9-81800-00	PH130-0076	112	6E0-45511-11	REC6E0-45511-11	345-387
6AW-15451-00	REC6AW-15451-00	214-272	6CB-11181-00	REC6CB-11181-00	216-218	6E0-45551-00	PAF4-03000007	285
6AW-41134-00	REC6AW-41134-01	270	6CB-13016-00	REC6CB-13016-00	70-71-72-73-88	6E0-45551-00	REC6E0-45551-00	345-387
6AW-4380R-00	REC48630-96J03	125	6CB-14984-00	REC6CB-14984-00	70-71-72-73-88	6E0-45560-00	REC6E0-45560-00	345-387
6AW-4380R-01	REC48630-92J00	125	6CB-24501-01	REC6CB-24501-01	70-72-73	6E0-45570-00	REC6E0-45570-00	345-387
6AW-43880-00	REC6AW-43880-02	123	6CB-45611-00	REC6CB-45611-00	335	6E0-45611-01	REC6E0-45611-01	345
6AW-43880-01	REC6AW-43880-02	123	6CE-12411-00	REC6CE-12411-00	73-137	6E0-45631-00	REC6E0-45631-00	345-387
6AW-43880-02	REC6AW-43880-02	123	6CE-44311-00	REC6CE-44311-01	148	6E0-45943-01	PAF4-03070000	287
6AW-44311-00	REC6AW-44311-01	148-341	6CE-44311-01	REC6CE-44311-01	148-335	6E0-45943-01-EL	PAF4-03070000	285-402
6AW-44311-01	REC6AW-44311-01	148	6CE-44315-00	REC6CE-44315-00	335	6E0-45943-01-EL	SOL3011-075-07S	402
6AW-44312-00	REC6AW-44312-00	335-341	6CE-44323-01	REC6CE-44323-01	335	6E0-45949-00	PAF2.6-03010000	287
6AW-44315-00	REC6AW-44315-00	341	6CE-44352-00	CEF500401N	143	6E0-85540-70	REC6E0-85540-71	119
6AW-44322-00	REC6AW-44322-00	335-341	6CE-44352-01	REC6CE-44352-00	155-335	6E0-85540-70	REC6E0-85540-71	119
6AW-44323-00	REC6AW-44323-00	341	6CE-W0078-00	REC6CE-W0078-01	153	6E0-85570-00	REC6E0-85570-00	104
6AW-44336-00	REC6AW-44336-00	341	6CE-W0078-01	REC6CE-W0078-01	73-153-334	6E0-W0001-C1	REC6E0-W0001-C1	144-285-345
6AW-44352-00	CEF500389N	143-155	6CJ-11181-00	REC6CJ-11181-00	205-215-218	6E0-W0078-00	PAGB/T820-M5X30	345
6AW-44352-00	REC6AW-44352-00	143-341	6CJ-44323-00	REC6CJ-44323-00	317	6E0-W0078-01	PAGB/T820-M5X30	345
6AW-44365-00	REC6AW-44365-00	335-341	6CJ-44324-00	REC6CJ-44324-00	317	6E0-W0078-02	PAGB/T820-M5X30	345
6AW-45113-00	REC6AW-45113-00	272	6CJ-81800-00	PH130-0056	111	6E0-W0078-02	REC6E0-W0078-02	150-153
6AW-45251	TEN01112-1	166-169	6D0-11181-00	REC6D0-11181-00	249-254	6E0-W0078-A2	REC6E0-W0078-A2	150-153-155-285-345
6AW-45251-00	CM6AW-45251-00	161-169	6D0-41134-00	REC6D0-41134-00	272	6E3-14301-05	REC6E3-14301-05	92-93
6AW-45251-00A	CM6AW-45251-00A	72-161-169	6D0-44362-01	REC6D0-44362-01	335-339	6E5-11181-A2	REC6E5-11181-A0	245-249-254
6AW-45373-00	CM6AW-45373-00	161-169	6D0-44367-00	REC6D0-44367-00	335-339	6E5-11193-A0	REC6E5-11193-A0	245-255
6AW-45373-00A	CM6AW-45373-00A	161-169-341	6D0-45332-00-CA	REC6D0-45332-00-CA	337	6E5-11325-00	CM15026	158-169
6AW-45373-00	TEN01155	166-169	6D0-45361-00-8D	REC6D0-45361-00-8D	337	6E5-11325-00	CM15026A	65-70-72-73-158-169-187-209-213
6AW-45373-00	TEN01155AL	166-169	6D0-81800-00	PH130-0076	112	6E5-11325-00	PAF15-07010026	183
6AW-45619-00	CM6AW-45619-00	161	6D0-W0001-00	REC6D0-W0001-00	252-254	6E5-11325-00	TEN01152	163-169-245-247
6AW-45619-00A	CM6AW-45619-00A	161-341	6D3-81960-00	REC881346T	117	6E5-11381-A1	REC6E5-11381-A1	275
6AW-45619-00	TEN01169	165	6D8-11603-01	REC6D8-11603-10	209	6E5-11381-A2	REC6E5-11381-A1	245-247
6AW-8194A-00	REC6AW-8194A-00	115	6D8-11604-01	REC6D8-11604-10	209	6E5-11411-00	REC6E5-11411-00	256
6AW-81950-00	REC6AW-81950-00	115	6D8-12121-00	REC6D8-12121-00	209	6E5-11447-00	REC6E5-11447-00	245-247
6AW-W0078-00	REC6AW-W0078-00	73-153-155-341	6D8-12121-01	REC6D8-12121-01	209	6E5-11610-02	REC6E5-11610-02	265-266-267
6B4-11193-A0	REC6B4-11193-A0	140	6D8-13761-00	REC6D8-13761-00	89-90	6E5-11633-01	REC6E5-11633-00	261-265
6B4-11351-A1	REC6B4-11351-A1	252	6D8-24563-00	REC6D8-WS24A-00	80	6E5-11634-00	REC6E5-11634-00	265
6B4-14301-00	REC6B4-14301-00	91-93	6D8-41114-A0	REC67F-41114-A2	209	6E5-11650-01	REC6E5-11650-01	261
6B4-26301-00	REC6B4-26301-00	129	6D8-43880-00	PH200-T068	123	6E5-11651-00	REC6E5-11651-00	261
6B4-45251-00	TEN01116	169-348	6D8-43880-01	REC6D8-43880-09	123	6E5-12411-00	REC6E5-12411-02	136
6B4-85520-00	REC6B4-85520-00	107	6D8-43880-09	PH200-T068	123	6E5-12411-01	REC6E5-12411-02	136-221-223-229-231-233
6B4-85540-01	REC6B4-85540-01	120	6D8-43880-09	REC6D8-43880-09	123	6E5-12411-02	REC6E5-12411-02	136-137
6B4-85570-00	REC6B4-85570-01	104	6D8-44341-01	REC688-44341-01	321	6E5-12411-10	REC6E5-12411-30	137
6B4-85570-01	REC6B4-85570-01	104	6D8-WS24A-00	REC6D8-WS24A-00	66-67-68-69-70-71-81	6E5-12411-20	REC6E5-12411-30	137-227-237-245-247
6B4-85580-00	REC6B4-85580-00	107	6D9-12411-00	REC6D9-12411-00	70-137	6E5-13411-00	REC6E5-13411-00	83
6BG-11181-00	REC6BG-11181-00	201-215-218	6D9-45551-00	REC6D9-45551-00	319	6E5-13621-A1	REC6E5-13621-A1	275
6BG-13761-00	REC6BG-13761-00	89-90	6DA-11181-00	REC6DA-11181-00	216-218	6E5-13645-A1	REC6E5-13645-A1-00	275
6BG-13915-00	REC6BG-13915-00	67-80	6DA-12411-01	REC6DA-12411-01	72-136-137	6E5-14198-A2	REC6E5-14198-A2	275
6BG-44341-00	PAT40-04040001	313	6DA-13761-00	REC6DA-13761-00	90	6E5-14323-03	REC6E5-14323-03	99
6BG-W0078-00	REC6BG-W0078-00	67-151-153-154-302	6E0-11193-A1	REC6E0-11193-A1	221	6E5-14328-01	REC6E5-14328-01	99
6BL-11181-00	REC6BL-11181-00	195-215-218	6E0-11631-00-98	REC6E0-11631-00-98K	221-262-266	6E5-14385-02	REC6E5-14385-02	93-100
6BL-11325-00	CM6BL-11325-00	161	6E0-11651-01	REC6E0-11651-01	221-225-260	6E5-14386-01	REC6E5-14386-01	99
6BL-11325-00	CM6BL-11325-00A	161-195	6E0-24411-00	REC6E0-24411-00	87	6E5-14386-02	REC6E5-14386-02	99
6BL-11325-00	TEN01161	166	6E0-24435-00	REC6E0-24435-00	87	6E5-14416-A1	REC6E5-14416-A1	275
6BL-44391-00	PAF15-05000009	139	6E0-24471-00	REC6E0-24471-00	87	6E5-14483-A1	REC6E5-14483-A1	275
6BR-81800-00	PH130-0073	112	6E0-26301-01	REC6E0-26301-01	129	6E5-14546-00	REC6E5-14546-00	93-98
6BR-81800-01	PH130-0073	112	6E0-41112-A1	REC6E0-41112-A1	140-21	6E5-24305-05-00	GS31076	76
6BX-11181-00	PAF6-04000002	179-215	6E0-41114-A1	REC6E0-41114-A1	140-221	6E5-24305-06-00	GS31076	76
6BX-11351-00	PAF6-04000001	179	6E0-43118-00	REC6E0-43118-00	134	6E5-24305-06-00	GS31076	76
6BX-11356-00	PAF6-04000005	179	6E0-43118-01	REC6E0-43118-01	134	6E5-24351-00	REC6E5-24351-51	75
6BX-12111-00	PAF6-04050001	179	6E0-44311-00	PAF4-03000019	154-345	6E5-24351-51	REC6E5-24351-51	75
6BX-12154-00	PAF6-04000003	179	6E0-44315-A0	PAF4-03000018	345	6E5-24377-00	PAF15-07010006	181-183
6BX-44322-00	PAF6-03000002	154-287	6E0-44322-02	PAF4-03000017	285	6E5-24410-01-00	REC6E5-24410-03	85
6BX-45113-00	PAF6-00000001	151-179-217	6E0-44322-02	REC6E0-44322-02	154-155-345	6E5-24411-00-00	REC6E5-24411-00	87
6BX-E1111-00-1S	PAF6-04050100	179	6E0-44323-00	PAF4-03000015	154-155-285-345	6E5-24434-02	REC6E5-24434-02	88
6BX-E1168-00	PAF6-04010004	179	6E0-44328-00	PAF4-03000020	345	6E5-24435-00	REC6E5-24435-00	88
6BX-E1191-00-5B	PAF6-04000004	179	6E0-44352-00	PAF4-03000020	345	6E5-24471-00	REC6E5-24471-00	87
6BX-E2155-00	PAF6-04050004	179	6E0-44366-00	PAF4-03000021	345	6E5-41112-A1	REC6E5-41112-A1	142-245
6BX-E2170-00	PAF6-04030000	179	6E0-45113-A1	REC6E0-45113-A1	221-252	6E5-41134-A0	REC6E5-41134-A0	269-270
6BX-F4323-00	PAF6-04000020	179				6E5-43880-00	PH200-T037	123
6BX-G4150-00	PAF4-03020000S	287						

R.O. / OEM	REF		R.O. / OEM	REF		R.O. / OEM	REF	
6E5-44150-01	REC6E5-44150-02	377	6E5-85540-12	REC6E5-85540-12	119	6F5-14390-21	REC6F5-14390-21	98
6E5-44311-00	REC61A-44311-00	148	6E5-85570-10	REC6E5-85570-11	105	6F5-14398-00	REC6F5-14398-00	94
6E5-44311-00	REC6E5-44311-00	155-156-157-381	6E5-85570-11	REC6E5-85570-11	105	6F5-14483-00	REC6F5-14483-00	94
6E5-44312-00	REC6E5-44312-00	325-329-333-339-385-386	6E5-W0001-A2	REC6E5-W0001-A2	251	6F5-15396-01-5B	REC6F5-15396-01-5B	235
6E5-44315-A0	REC6E5-44315-A0	156-157-325-329-333-377-381-385	6E5-W0001-A2	REC6E5-W0001-A2	254	6F5-15713-00	REC66T-15713-00	112
6E5-44322-00	REC6E5-44322-00	156-157-381	6E5-W0001-F1	REC6E5-W0001-F1	147-374-378	6F5-15713-01	REC66T-15713-01	112
6E5-44323-00	REC6E5-44323-00-40	149-155-156-157-377	6E5-W0078-02	REC6E5-W0078-02	374	6F5-24563-00	REC6F5-24563-00	80-81-82
6E5-44352-01	CEF500371	143	6E5-W0093-06	REC6E5-W0093-06	97-245	6F5-26311-00	REC6F5-26311-00	129
6E5-44352-01	REC6E5-44352-01	143-155-156-157-325-329-333-339-377-381-385-386	6E5-W0093-07	REC6E5-W0093-07	97	6F5-41111-01-1S	REC6F5-41111-01-1S	235
6E5-44365-00	REC6E5-44365-00	155-157-325-329-333-339-377-381-385-386	6E5-W0093-08	REC6E5-W0093-08	97	6F5-41112-A0	REC6F5-41112-A0	141-235
6E5-44366-00	REC6E5-44366-00	155-156-157-325-333-339-377-381	6E7-11111-01-1S	REC6E7-11111-01-1S	227	6F5-41113-01-1S	REC6F5-41113-01-1S	235
6E5-45113-A0	REC6E5-45113-A2	253-254	6E7-11181-A2	REC6E7-11181-A2	248-254	6F5-41114-A0	REC6F5-41114-A0	142-235
6E5-45114-A0	REC6E5-45114-00	272	6E7-11631-00	REC6E7-11631-00K	262	6F5-44352-00	CEF500352	143
6E5-45251-00	CM6E5-45251-00	158-169	6E7-11631-00-97	REC6E7-11631-00K	227-266	6F5-44352-02	REC6F5-44352-02	156-367
6E5-45251-00	TEN01105	164-169	6E7-11635-00	REC6E7-11635-00K	227-262	6F5-45113-A0	REC6F5-45113-A0	235-253-254
6E5-45251-00	TEN01129	165	6E7-11636-00	REC6E7-11636-00K	227-262	6F5-45312-01-4D	REC6F5-45312-00-4D	363
6E5-45300-16-8D	REC405-A20	375	6E7-14227-00	REC6E7-14227-00	94	6F5-45551-00	REC6F5-45551-00	363-389-390
6E5-45300-17-8D	REC405-A20	280	6E7-14385-00	REC6E7-14385-00	93-100	6F5-45560-00	REC6F5-45560-00	363-389-390
6E5-45300-26-8D	REC405-A25	375	6E7-44366-00	REC6E7-44366-00	349	6F5-45570-00	REC6F5-45570-00	363-389-390
6E5-45300-27-8D	REC405-A25	280	6E7-45331-00-9M	REC6E7-45331-00-CA	349	6F5-81800-10	PH130-0062	110
6E5-45321-00	REC6E5-45321-00	325-329-377-381	6E7-45501-00	REC6E7-45501-00	349	6F5-81800-11	PH130-0062	110
6E5-45331-00-94	REC6E5-45331-00-94	377-381	6E7-45501-10	REC6E7-45501-11	349-387-388	6F5-85540-22	REC6F5-85540-22	119
6E5-45331-00-9S	REC6E5-45331-00-94	325-329	6E7-45536-00	REC6E7-45536-00	349	6F5-W0001-C0	REC6F5-W0001-C0	145-363
6E5-45331-00-9S	REC6E5-45331-00-94	391	6E7-45551-00	REC6E7-45551-00	348-387-388	6F5-W0078-00	REC6F5-W0078-A0	151
6E5-45332-00-94	REC6E5-45332-00-94	375	6E7-45560-00	REC6E7-45560-01	349	6F5-W0078-A0	REC6F5-W0078-A0	156-363
6E5-45332-00-CA	REC6E5-45332-00-94	323	6E7-45560-01	REC6E7-45560-01	291-293-351-387-388	6F6-11111-00-1S	REC6F6-11111-00-1S	235
6E5-45344-00	REC6E5-45344-00	325-329-333-339-377-381-385	6E7-45570-00	REC6E7-45570-00	293	6F6-11191-00-1S	REC6F6-11191-00-1S	235
6E5-45371-00	CM6E5-45371-01A	323	6E7-45571-00	REC6E7-45571-00	291-349-351-387-388	6F6-11193-A1	REC6F6-11193-A1	235-255
6E5-45371-00	TEN01153	164	6E7-45587-01-30	PAF15-06000009	348	6F6-11400-01	REC6F6-11400-02	235
6E5-45371-01	CM6E5-45371-01A	161-379	6E7-45987-00	REC6E7-45987-00	291-349	6F6-11610-00	REC6F5-11610-00	235
6E5-45371-01	REC6E5-45371-01	161-169-375	6E7-45987-01	PAF15-06000015	351	6F6-11610-010	REC6F5-11610-10	235
6E5-45371-10	CM6E5-45371-10	160	6E7-45987-01	REC6E7-45987-00	293-351-405	6F6-11610-20	REC6F5-11610-20	235
6E5-45371-10	TEN01153	370-375	6E7-85570-19-00	REC6E7-85570-19	106	6F6-11631-00-95	REC6F6-11631-00K	235-263
6E5-45501-01	REC6E5-45501-01	377-391	6E7-W0001-00	REC6E7-W0001-A1	249	6F6-11635-00	REC6F6-11635-00K	235-263
6E5-45536-00	REC6E5-45536-00	325-377	6E7-W0001-A1	REC6E7-W0001-A1	249-254	6F6-11636-00	REC6F6-11636-00K	235-263
6E5-45536-01	REC6E5-45536-00	329	6E7-W0093-04	REC6E7-W0093-01	95	6F6-13610-00	REC6F6-13610-00	99
6E5-45551-02	REC6E5-45551-00	375-391	6E8-14390-12	REC6E8-14390-12	98	6F6-14301-06	REC6F6-14301-06	91
6E5-45560-01	REC6E5-45560-00	375-391	6E8-45251-00	CM6E8-45251-00	159	6F6-14341-00	REC6F6-14341-00	98
6E5-45567-01	REC6E5-45567-01	323	6E8-45251-00	TEN01106	164	6F6-14385-00	REC6F6-14385-00	100
6E5-45567-01-60	REC6E5-45567-01	375	6E8-45251-02	CM6E8-45251-01	159-169	6F6-45611-00	REC6F6-45611-00	363-389-390
6E5-45571-01	REC6E5-45570-00	323-375	6E8-45251-02	TEN01116	164	6F6-85530-01	REC6F6-85530-01	106
6E5-45576-00	REC6E5-45576-00	323-375	6E8-45587-10	PAF15-06000008	293	6F6-85540-01	REC6F6-85540-01	118
6E5-45587-01	REC6E5-45587-01	325-329-377	6E8-45587-10-13	PAF15-06000008	291-351	6F6-W0001-02	REC6F6-W0001-02	234-251
6E5-45611-00	REC6E5-45611-00	323	6E8-45587-30	PAF15-06000009	293	6F6-W0093-00	REC6F6-W0093-00	96-234
6E5-45611-01	REC6E5-45611-00	375-391-392	6E9-11193-A0	REC6E9-11193-A0	255	6F8-11181-A1	REC6F8-11181-A0	220-248-254
6E5-45631-01	REC6E5-45631-00	375-391-392	6E9-12413-00-1S	REC6E9-12413-00-1S	139-235	6FM-12411-00	REC6FM-12411-00	66-136-137
6E5-45633-01	REC6E5-45633-01	323-327-335-375-379-391-392	6E9-12414-01	REC6E9-12414-A1	138-139-235	6FM-13761-00	REC6FM-13761-00	90
6E5-45634-01	REC6E5-45634-01	323-327-375	6E9-14198-A0	REC6E9-14198-A0	275	6FP-12411-00	REC6FP-12411-00	70-137
6E5-45634-02	REC6E5-45634-01	327	6E9-24378-00	PAF4-04010102	187	6G0-11181-00	REC6G0-11181-00	261
6E5-45641-02	REC6E5-45641-03	375	6E9-41114-A0	REC6E9-41114-A0	142	6G0-82519-00	PAF6-04000009	179
6E5-45641-03	REC6E5-45641-03	327-379	6E9-81970-70	REC6G1-81970-62	116	6G0-85540-11	REC6G0-85540-11	119
6E5-45941-00-EL	SOL3411-130-19	402	6E9-82575-00	REC6G1-81970-62	116	6G1-11193-A1	REC6G1-11193-A1	140-223
6E5-45941-00-EL	SOL3413-125-19	402	6E9-82575-00	REC6E9-82575-02	120	6G1-11610-00	REC6G1-11610-00	221-262-266
6E5-45943-00-EL	SOL3411-130-21	402	6E9-W0093-02	REC6E9-W0093-02	96	6G1-11633-00	REC6G1-11633-00	221-225-260-262
6E5-45943-00-EL	SOL3413-125-21	402	6E9-W0093-03	REC6E9-W0093-03	96	6G1-11681-00	REC6G1-11681-00	221-223-225-260
6E5-45945-00-EL	SOL3411-133-17	402	6EE-E5362-00	PAF4-04000036	177	6G1-13621-A1	REC6G1-13621-A1	273
6E5-45945-00-EL	SOL3413-128-17	402	6EE-E5396-00-CA	PAF4-04060000	177	6G1-13645-A1	REC6G1-13645-A1	273
6E5-45947-00-EL	SOL3411-135-15	402	6EE-F4251-00	REC6E8-24251-00	80	6G1-14198-A1	REC6G1-14198-A1	273
6E5-45947-00-EL	SOL3413-130-15	402	6EE-G2177-00	PAF4-01090300	134	6G1-14198-A1	REC6G1-14198-A1	273
6E5-45949-00-EL	SOL3411-138-13	402	6EE-G4315-00	PAF4-03000018	64-154	6G1-14301-01	REC6G1-14301-01	91-93
6E5-45949-00-EL	SOL3413-133-13	402	6EE-G4366-00	PAF4-03000021	154-155	6G1-14546-01	REC6G1-14546-00	93-98
6E5-45954-00-EL	SOL3411-140-11	402	6EE-G5987-00	PAF4-03000025	405	6G1-15755-00	PAF4-04130100	113
6E5-45978-01	REC6E5-45987-00	379	6EE-W0078-00	REC6EE-W0078-01	150	6G1-15779-00	PAF4-04130100	113
6E5-45987-01	REC6E5-45987-00	375-405	6EE-W0078-01	REC6EE-W0078-01	150	6G1-24304-02	REC6G1-24304-02	77
6E5-61301-00	GS41084	130	6EG-G2138-00	PAF4-01090100	131	6G1-24305-00	GS31075	76
6E5-61301-01	GS41084	130	6EK-13761-00	REC6EK-13761-00	90	6G1-24305-02	GS31075	76
6E5-81800-10	PH130-0005	110	6EK-4380R-00	REC48630-92J00	125	6G1-24305-02-00	GS31075	76
6E5-81800-11	PH130-0005	110	6EK-44323-00	REC68V-44323-00	149-155-269-325	6G1-24305-03	GS31075	76
6E5-81800-12	PH130-0005	110	6F3-W0001-21	REC6E5-W0001-F1	147	6G1-24305-04	GS31075	76
6E5-81900-01	REC6E5-81900-01	84	6F3-W0001-A4	REC6F3-W0001-04-00	251	6G1-24305-04-00	GS31075	76
6E5-81941-11	REC61A-81941-00	114	6F5-11181-A1	REC6F5-11181-A2	235	6G1-24305-05	GS31075	76
6E5-81950-01	PH375-0047	110-115	6F5-11181-A2	REC6F5-11181-A2	248-254	6G1-24305-05-00	GS31075	76
6E5-81950-01	REC89-825096T01	114	6F5-11193-A0	REC6G5-11193-A0	247	6G1-24305-0500	GS31075	76
6E5-8195A-01	PH375-0048	115	6F5-11515-00	REC6F5-11515-00	233-235	6G1-24306-55	PAF15-09000000	74
6E5-8195C-01	PH375-0048	115	6F5-11610-00	REC6F5-11610-00	263	6G1-24411-00	REC6G1-24411-00	87
6E5-82570-05	REC704-82570-12	128	6F5-11610-10	REC6F5-11610-10	263	6G1-24431-01	REC6E0-24434-00	87
6E5-85510-10	REC6E5-85510-11	121	6F5-11610-20	REC6F5-11610-20	263	6G1-24431-01	REC6G1-24431-01	87
6E5-85510-11	REC6E5-85510-11	121	6F5-11633-00	REC6F5-11633-00	233-235-260-261-263	6G1-24471-00	REC6G1-24471-00	87
6E5-85540-10	REC6E5-85540-12	119	6F5-11650-11	REC6R5-11650-10	247	6G1-41112-A1	REC6G1-41112-A1	140-223
6E5-85540-11	REC6E5-85540-12	119	6F5-11651-00	REC6F5-11651-00	233-235-260-261	6G1-41114-A0	REC6G1-41114-A0	140-223
			6F5-11681-00	REC6F5-11681-00	235-261	6G1-41133-A0	REC6G1-41133-A0	268
			6F5-					

R.O. / OEM	REF		R.O. / OEM	REF		R.O. / OEM	REF	
6G1-45214-00	PAF15-06000003	289-293-350	6G5-81960-A0	REC6G5-81960-A0	116	6H1-W0093-01-00	REC6H1-W0093-01-00	243
6G1-45215-00	PAF15-06000002	289	6G5-85510-10	REC6G5-85510-11	121	6H1-W0093-10	REC6H1-W0093-10	97
6G1-45251-02	CM6G1-45251-02	159-169	6G5-85540-10	REC6G5-85540-12	119	6H14525102	CM6H1-45251-02	158-169
6G1-45251-02	TEN01108	165-169	6G5-85540-11	REC6G5-85540-12	119		CM6H1-45251-02A	69-70-71-158-169
6G1-45251-03	CM6G1-45251-03	159-169	6G5-85540-12	REC6G5-85540-12	119			
6G1-45251-03	TEN01118	164-169	6G5-W0001-03	REC6G5-W0001-A3	252	6H2-81960-10	REC6H2-81960-10	116
6G1-45315-A0	REC6G1-45315-A0	346	6G5-W0001-03	REC6G5-W0001-A3	254	6H2-85540-10	REC6H2-85540-13	118
6G1-45316-09	REC6G1-45316-09	289	6G5-W0001-A3-00	REC6G5-W0001-A3	247	6H2-85540-11	REC6H2-85540-13	118
6G1-45317-09	REC6G1-45317-09	289	6G5-W0078-00	REC6G5-W0078-A1	152	6H2-85540-12	REC6H2-85540-13	118
6G1-45362-09	REC6G1-45362-09	289	6G5-W0078-01	REC6G5-W0078-A1	152	6H2-85540-13	REC6H2-85540-13	118
6G1-45611-01	REC6G1-45611-01	346-387	6G5-W0078-A1	REC6G5-W0078-A1	152-157-378	6H2-W0001-20	REC6H2-W0001-20	146
6G1-45631-00	REC6G1-45631-00	346-387	6G8-11181-00	REC6G8-11181-A1	181	6H2-W0093-10	REC6H2-W0093-10	96-241
6G1-45941-00-EL	SOL3011-085-09	402	6G8-11181-A1	REC6G8-11181-A1	215-218	6H3-11181-A2	REC6H3-11181-A0	241-248-254
6G1-45943-00-EL	SOL3011-085-08	402	6G8-11197-01	PAF20-05030009	203-205	6H3-11193-A1	REC6H3-11193-A1	241-255
6G1-45947-00-EL	SOL3011-085-07	402	6G8-11197-A0	PAF20-05030009	187	6H3-11325-01	CM6H3-11325-01A	241
6G1-81940-00	REC89-825096T01	114	6G8-11325-00	CM6G8-11325-00	159-169-181	6H3-11631-01-96	REC6H3-11631-01K	241-262-266
6G1-81941-10	PAF15-05170300W	111-114			65-159-180-187-195-201-203-205	6H3-11633-00	REC6H3-11633-00	241-261-262-264
6G1-81941-10	REC89-825096T01	110	6G8-11325-00	CM6G8-11325-00A	163-169	6H3-11635-01	REC6H3-11635-01K	241-262
6G1-81970-00	REC6G1-81970-62	116			181	6H3-11636-01	REC6H3-11636-01K	241-262
6G1-81970-60	REC6G1-81970-62	116	6G8-11325-00	TEN01148	181	6H3-12411-00	REC6H3-12411-00	137
6G1-81970-61	REC6G1-81970-62	116	6G8-11351-00	REC6G8-11351-A0	217	6H3-12411-01	REC6H3-12411-01	137
6G1-81970-62	REC6G1-81970-62	116	6G8-11351-A0	REC6G8-11351-A0	218	6H3-12411-10	REC6H3-12411-10	137-241
6G1-81970-A0	REC6G1-81970-62	116	6G8-12411-00	REC6G8-11351-A0	181	6H3-12411-11	REC6H3-12411-10	137
6G1-W0001-C0	REC6G1-W0001-C1	144	6G8-12411-02	REC6AH-12411-00	191	6H3-12413-00-1S	PAF15-07010021	197-207-241
6G1-W0078-00	REC6G1-W0078-A1	150	6G8-12411-03	PAF15-07000031	195-197-201-203-205-207	6H3-12413-00-9M	PAF15-07010021	191
6G1-W0078-01	REC6G1-W0078-A1	150			66-67-68-69	6H3-12413-001S	PAF15-07010021	183
6G1-W0078-A1	REC6G1-W0078-A1	150-346	6G8-12411-03	PAF15-07000031	137	6H3-12414-A1	REC6H3-12414-A1	138-241
6G1-W0093-00	REC6G1-W0093-00	93-95-223	6G8-12414-00	REC6G8-12414-A0	181	6H3-13621-A1	REC6H3-13621-A1	274
6G5-11181-A3	REC6G5-11181-A2	247-249-254	6G8-12414-A0	REC6G8-12414-A0	138	6H3-13622-A1	REC6H3-13622-A1	274
6G5-11193-A1	REC6G5-11193-A0	255	6G8-13440-00	REC6G8-13440-00	83	6H3-14198-A1	REC6H3-14198-A1	274
6G5-11382-A1	REC6G5-11382-A1	142-245-247	6G8-13645-00	REC6G8-13645-00	273	6H3-14457-01	REC6H3-14457-01	94
6G5-11411-02	REC6G5-11411-02	247-256	6G8-13646-00	REC6G8-13646-A0	273	6H3-14590-01	REC6H3-14590-00	93-98
6G5-11631-00-93	REC6G5-11631-00K	265-266-267	6G8-14198-00	REC6G8-14198-A0	273	6H3-41112-A0	REC6H3-41112-A0	141-241
6G5-11642-00-93	REC6G5-11642-00K	265-266-267			181-185-187-191-195-197-201-203-205-207-209-211	6H3-41114-A0	REC6H3-41114-A0	141-241
6G5-12416-00	REC6G5-12416-00	209-211	6G8-15363-00	PAF15-07050004	213-214	6H3-41217-00	REC6H3-41217-00	101
6G5-13645-A2	REC6G5-13645-A1	276			273	6H3-44311-00	REC6H3-44311-00	148
6G5-14416-A1	REC6G5-14416-A1	275	6G8-15374-00	REC6G8-15374-00	140-181	6H3-44315-00	REC6H3-44315-00	154-156
6G5-14483-A1	REC6G5-14483-01	276	6G8-41112-02	REC6G8-41112-02	140	6H3-44323-00-00	REC6H3-44323-00	149-154-156
6G5-41112-A1	REC6G5-41112-A1	142-247	6G8-41114-00	REC6G8-41114-00	140	6H3-44352-00	REC6H3-44352-00	143
6G5-41114-A0	REC6G5-41114-A0	142-247	6G8-44532-00	PAF2.6-04000009	171		REC6H3-44352-00	143-154-156-313-317
6G5-41134-A1	REC6G5-41134-A1	270	6G8-45113-A1	REC6G8-45113-A1	271	6H3-44391-00	PAF15-05000009	139
6G5-41217-01	REC6G5-41217-00	101	6G8-45251-00	REC6G8-45251-01	159-169	6H3-44391-01	PAF15-05000009	139
6G5-43864-00	REC6G5-43864-00	125	6G8-45251-01	CM6G8-45251-01	159-169	6H3-45113-00	REC6H3-45113-00	241
6G5-43880-00	PH200-T030	123	6G8-46241-00	TEN01137	164-169	6H3-45113-A0	REC6H3-45113-A0	253-254
6G5-43880-01	PH200-T030	123	6G8-81800-10	REC6G8-46241-00	267	6H3-45114-A1	REC6H3-45114-A1	271
6G5-43880-02	PH200-T030	123	6G8-81800-11	PH130-0062	110	6H3-45123-00	REC6H3-45123-00	269
6G5-44150-02	REC6G5-44150-02	381	6G8-81800-11	PH130-0062	110	6H3-45127-00	REC6H3-45127-00	269
6G5-44323-00	REC6G5-44323-00	329-333-381-385	6G8-81870-00	REC6G8-81870-00	120	6H3-81800-10	PH130-0050	111
6G5-44323-00	REC6G5-44323-00	155-157	6G8-81960-A1	REC6G8-81960-A1	117	6H3-81800-11	PH130-0050	111
6G5-44323-01	REC6G5-44323-00	149	6G8-W0001-A3	REC6G8-W0001-A3	181-216-218	6H3-82510-00	REC6H3-82510-03	114
6G5-45113-A1	REC6G5-45113-A1	245-247	6G9-85540-20	REC6G9-85540-29	117-118	6H3-82510-01	REC6H3-82510-03	114
6G5-45113-A2	REC6G5-45113-A1	253-254	6G9-85540-21	REC6G9-85540-29	117-118	6H3-82510-02	REC6H3-82510-03	114
6G5-45114-A1	REC6G5-45114-A0	272	6G9-85540-22	REC6G9-85540-29	117-118	6H3-82510-03	REC6H3-82510-03	114
6G5-45251-01	CM6G5-45251-01	158-169	6G9-85540-29	REC6G9-85540-29	117-118	6H3-85470-10	REC6H3-85570-10	104
6G5-45251-01	CM6G5-45251-01A	70-158-169	6G9-W0001-C4	REC6G9-W0001-C4	144	6H3-85520-00	REC6H3-85520-00	107
6G5-45251-01	TEN01112	166-169	6G9-W0001-C6	REC6G9-W0001-C6	144	6H3-85540-10	REC6H3-85540-10	118
6G5-45251-01	TEN0112AL	166-169	6G8-45251-00	CM6G1-45251-03	159	6H3-85540-10	REC6H3-85540-13	118
6G5-45251-02	TEN01112	166-169	6H0-81960-00	REC6H0-81960-00	116	6H3-85540-11	REC6H3-85540-11	118
6G5-45251-02	TEN0112AL	166-169	6H0-82105-02	PAT85-05000023	112	6H3-85540-12	REC6H3-85540-13	118
6G5-45383-01	REC6G5-45383-01	327-379	6H0-82105-J2	PAT85-05000023	112	6H3-85540-12	REC6H3-85540-11	118
6G5-45384-00	REC6G5-45384-00	327-379	6H0-W0093-00	REC6H0-W0093-00	97	6H3-85540-13	REC6H3-85540-13	118
6G5-45501-21	REC6G5-45501-21	381-391-392	6H1-11372-00	PAF15-04000005	187	6H3-W0001-02	REC6H3-W0001-02	241-250-254
6G5-45536-01	REC6G5-45536-01	381	6H1-11631-03-95	REC6H1-11631-03K	264-266	6H3-W0001-22	REC6H3-W0001-22	145
6G5-45551-01	REC6G5-45551-00	379-391-392	6H1-14485-00	PAT15-04010202	171	6H3-W0078-00	REC6H3-W0078-00	68-69-152-154-156
6G5-45560-01	REC6G5-45560-00	379-391-392	6H1-15359-01-94	REC6H1-15359-01-94	243	6H3-W0093-02	REC6H3-W0093-02	93-97
6G5-45571-02	REC6G5-45571-00	379-391-392	6H1-43800-13-4D	REC6H1-43800-17-8D	124	6H4-11181-A2	REC6H4-11181-00	248-254
6G5-45576-10	REC6G5-45576-10	327	6H1-43800-14-4D	REC6H1-43800-17-8D	124	6H4-11193-00	REC6H4-11193-A1	255
6G5-45631-00	REC6G5-45631-00	379-391-392	6H1-43800-15-4D	REC6H1-43800-17-8D	124	6H4-11610-00	REC6H4-11610-00-00	264-266
6G5-45941-00-98	SOL3511-150-15	403	6H1-43800-16-4D	REC6H1-43800-17-8D	124	6H4-11631-00-96	REC6H4-11631-00K	264-266
6G5-45941-00-98	SOL3513-148-15	403	6H1-43800-17-8D	REC6H1-43800-17-8D	122	6H4-11631-01-95	REC6H4-11631-01K	237-263-266
6G5-45941-00-98	SOL3571-158-15	403	6H1-43880-00	PH200-T041	122	6H4-11634-01	REC6H4-11634-01	237-263-264
6G5-45945-01-98	SOL3511-145-19	403	6H1-44144-00	PH200-T029	122	6H4-11635-00	REC6H4-11635-00K	264
6G5-45945-01-98	SOL3513-143-19	403	6H1-45214-00	REC6H1-44144-00	373	6H4-11635-01	REC6H4-11635-01K	237-263
6G5-45945-01-98	SOL3571-153-19	403	6H1-45215-00	REC6H1-45214-00	315-319	6H4-11636-00	REC6H4-11636-00K	264
6G5-45947-01-98	SOL3511-148-17	403	6H1-45251-01	REC6H1-45215-00	315-319	6H4-11636-01	REC6H4-11636-01K	237-263
6G5-45947-01-98	SOL3513-145-17	403	6H1-45251-01	CM6H1-45251-01	158-169	6H4-11641-00	REC6H4-11641-00	237-261
6G5-45947-01-98	SOL3571-155-17	403	6H1-45251-01	CM6H1-45251-01A	158	6H4-14198-00	REC6H4-14198-00	274
6G5-45949-00-98	SOL3511-142-23	403	6H1-45251-02	TEN01125	167	6H4-14198-01	REC6H4-14198-01	274
6G5-45949-00-98	SOL3511-143-21	403	6H1-45251-02	TEN01115AL	166-169	6H4-14548-00	PAF25-05070019	99
6G5-45949-00-98	SOL3512-142-23	403	6H1-45251-03	TEN01113	166-169	6H4-14984-00	REC6H4-14984-00	94
6G5-45949-00-98	SOL3513-140-21	403	6H1-45611-01-00	REC6H1-45611-00	373-390-391	6H4-14985-00	REC6H4-14985-00	100
6G5-45949-00-98	SOL3571-148-23	403	6H1-45631-01-00	REC6H1-45631-01	373-390-391	6H4-14985-01	REC6H4-14985-01	100
6G5-45949-00-98	SOL3571-150-21	403	6H1-45634-02	REC6H1-45634-02	373	6H4-15369-A1		

R.O. / OEM	REF		R.O. / OEM	REF		R.O. / OEM	REF	
6H4-44352-02	REC6H4-44352-02	154-155-156	6K7-W0093-09	REC6K7-W0093-09	97	6P2-24563-00	REC6P2-WS245-00	81
6H4-45113-00	REC6H4-45113-00	237	6K8-41122-A1	REC6K8-41122-A1	141-229	6P2-41112-00	REC6P2-41112-00	213
6H4-45113-A0	REC6H4-45113-00	253-254	6K8-41124-A1	REC6K8-41124-A1	141-229	6P2-41114-00	REC6P2-41114-00	213
6H4-45536-00	PAT40-04000002	301-305-309-313	6L2-11181-A3	REC6L2-11181-A1	248-254	6P2-41122-00	REC6P2-41122-00	213
6H4-45551-00	REC6H4-45551-00	359-389-390	6L2-11193-A1	REC6L2-11193-A1	255	6P2-44150-00	REC6P2-44150-00	339
6H4-45560-00	REC6H4-45560-00	359-389-390	6L2-13621-00	REC6L2-13621-00	274	6P2-44323-00	REC6P2-44323-00	149
6H4-45571-00	REC6H4-45570-00	359-389-390	6L2-14384-00	REC6L2-14384-00-00	94	6P2-44323-00	REC6P2-44323-00	155-157-339
6H4-45631-00	REC6H4-45631-00	389-390	6L2-14385-00	REC6L2-14385-00	93-100	6P2-45300-20-8D	REC422-B25F	278-339
6H4-81800-10	PH130-0063	110	6L2-14399-00	REC6L2-14399-00	94	6P2-45300-21-8D	REC422-B25F	278-339
6H4-81800-11	PH130-0063	110	6L2-26301-00	REC6L2-26301-00	129	6P2-45300-40-8D	REC422-B25F	278
6H4-81800-12	PH130-0063	110	6L2-41112-A2	REC6L2-41112-A3	141	6P2-45300-41-8D	REC422-B25F	278
6H4-W0001-01	REC6H4-W0001-A1	250-254	6L2-41114-A1	REC6L2-41114-A1	141	6P2-45331-00-9S	REC6P2-45331-00-9S	339
6H4-W0001-04	REC6H4-W0001-04	237-250	6L2-41133-A3	REC6L2-41133-A3	268	6P2-45501-00	REC6P2-45501-01	339
6H4-W0001-21	REC6H4-W0001-21	359	6L2-41134-00	REC6L2-41134-00	268	6P2-45501-10	REC6P2-45501-11	339
6H4-W0078-00	REC6H4-W0078-00	151	6L2-44322-00	REC6L2-44322-00	155	6P2-46241-01	REC6P2-46241-02	213
6H4-W0078-A0	REC6H4-W0078-00	155-156-359	6L2-44352-00	CEF500384	143	6P2-46241-02	REC6P2-46241-02	267
6H4-W0093-01	REC6H4-W0093-01-00	96	6L2-44352-00	REC6L2-44352-00	66-143-155	6P2-81960-02	REC6P2-81960-03	116
6H4-W0093-03	REC6H4-W0093-03	96-237	6L2-44367-00	PAF25-04050004	293-297-355	6P2-81960-03	REC6P2-81960-03	116
6H5-43880-00	PH200-T048	122	6L2-45113-A1	REC6L2-45113-A2	253-254	6P2-W0001-00	REC6P2-W0001-01	217
6H5-43880-01	PH200-T048	122	6L2-45214-00	PAF25-04000022	295	6P2-W0001-01	REC6P2-W0001-01	213-217-218
6H5-43880-02	PH200-T048	122	6L2-45215-00	PAF25-04000023	295	6P2-W0078-00	REC6P2-W0078-00	73-153-155-157
6H5-43880-09	PH200-T048	122	6L2-45567-12	PAF25-04000004-3	295	6P2-WS245-00	REC6P2-WS245-00	81
6H9-45551-00	REC6H9-45551-00	365-389	6L2-45567-14	PAF25-04000004-5	295	6P245300208D	REC422-B25F	278
6J1-11610-00	REC6J1-11610-00	221	6L2-45577-00-10	PAF25-04070005-1	295-355	6P245300218D	REC422-B25F	278
6J4-81800-00	PH130-0062	110	6L2-45577-00-12	PAF25-04070005-3	295	6P245300408D	REC422-B25F	278
6J4-81800-01	PH130-0062	110	6L2-45611-00	REC6L2-45611-00	355-388-389	6P245300418D	REC422-B25F	278
6J8-11181-A1	REC6J8-11181-A2	231	6L2-45987-01	REC6L2-45987-00	295-355-357-405	6P3-24563-00	REC6P3-WS24A-00	81
6J8-11181-A2	REC6J8-11181-A2	248-254	6L2-81800-10	PH130-0061	110	6P3-24564-00	REC6P3-24564-00	71-72-73-81
6J8-11325-00	TEN01150	163-229-231	6L2-81800-11	PH130-0061	110	6P3-45300-40-8D	REC422-B25F	278-339
6J8-11631-02-97	REC6J8-11631-02	231-263-266	6L2-81800-12	PH130-0061	110	6P3-45300-41-8D	REC429-B25F	278-339
6J8-12414-A0	REC61A-12414-A0	237	6L2-W0001-A2	REC6L2-W0001-03	250-254	6P3-45300-42-8D	REC429-B25F	278
6J8-13411-00	REC6J8-13411-00	83	6L2-W0001-C3	REC6L2-W0001-C3	145	6P3-WS24A-00	REC6P3-WS24A-00	81
6J8-24471-00	REC6J8-24471-00	87	6L2-W0078-00	REC6L2-W0078-00	151-155	6P3-WS24A-01	REC6P3-WS24A-00	71-72-73-81
6J8-44311-00	REC663-44311-02	357	6L2-W0093-00	REC6L2-W0093-00	95	6P345300408D	REC429-B25F	278
6J8-45113-A0	REC6J8-45113-00	231-253-254	6L5-14301-03	REC6L5-14301-03	91-93	6P345300418D	REC429-B25F	278
6J8-81960-00	PAF15-07060001	117	6L5-24251-00	PAF4-04120005	64-80-81-82	6P345300428D	REC429-B25F	278
6J8-85540-H2	REC6J8-85540-H2	120	6L5-44322-00	PAF2.6-03000015	154-283	6R0-44366-00	PAF4-03000021	283
6J8-W0001-21	REC6J8-W0001-21	145-357	6L5-44323-00	REC6L5-44323-00	149	6R3-11411-00	REC6R3-11411-00	256
6J8-W0078-A1	REC6J8-W0078-A2	150-151	6L5-44352-00	CEF500322	143	6R3-81960-10	REC6R3-81960-10	116
6J8-W0078-A2	REC6J8-W0078-A2	155-357	6L5-44352-00	PAF2.6-03000100	64-283	6R3-82563-01	REC6R3-82563-01	122
6J9-45332-00-CA	REC6J9-45332-00-CA	327-379-391-392	6L5-44352-00	REC6L5-44352-00	143-154	6R3-82563-01	REC6R3-82563-01	122
6J9-45371-00	TEN01143	165	6L5-45251-02	CM6L5-45251-02	159-343	6R3-85570-01104	REC6R3-85570-01	104
6J9-45371-01	CM6J9-45371-01	160-169	6L5-45251-02	CM6L5-45251-02	169	6R3-W0001-A3	REC6R3-W0001-03	252
6J9-45371-01	CM6J9-45371-01A	72-160-169-327	6L5-45251-02	CM6L5-45251-02A	159	6R4-13200-00	REC6R4-13200-02	84
6J9-45371-01	TEN01133	165-169	6L5-45251-02	TEN01117	166-169	6R4-13200-01	REC6R4-13200-02	84
6J9-45371-01	TEN01133AL	165-169	6L5-45251-03	CM6L5-45251-02	345	6R4-13200-02	REC6R4-13200-02	84
6J9-45371-02	CM6K1-45371-02	160-169	6L5-45316-09	PAF2.6-03000003	283	6R5-11361-11-93	REC6R5-11361-11K	245
6J9-45371-02	CM6K1-45371-02A	72-160-169	6L5-45317-09	PAF2.6-03000002	283	6R5-11603-00	REC6R5-11603-00	265-266-267
6J9-45611-01	REC6J9-45611-00	327-379-391-392	6L5-45533-00-20	PAF2.6-03000017	283	6R5-11631-11-93	REC6R5-11631-01K	265-266-267
6K1-45371-00	CM6K1-45371-00	161-169	6L5-45551-00	PAF2.6-03000018	283	6R5-11633-10	REC6R5-11633-00	245-247-261-265
6K1-45371-00	CM6K1-45371-00A	161-169	6L5-45560-00	PAF2.6-03000019	283	6R5-11634-00	REC6R5-11634-00	265
6K1-45371-00	TEN01144	168-169	6L5-45616-00	PAF4-03080000	283-285-287-405	6R5-11634-10	REC6R5-11634-00	245-247-265
6K1-45371-00	TEN01144AL	168-169	6L5-45616-02	REC647-45616-02	345	6R5-11642-11-93	REC6R5-11642-01K	245-265-266-267
6K1-45371-02	TEN01134	165-169	6L5-45631-00	PAF2.6-03000201	283	6R5-11642-11-93	REC6R5-11642-11K	265-266-267
6K1-45945-01-98	SOL3512-145-19	403	6L5-45631-00	PAF2.6-03000202	283	6R5-116950-00	REC6R5-11650-10	245
6K1-45945-01-98	SOL3514-143-19	403	6L5-45943-00-EL	PAF2.6-03010000	283	6R6-W0001-02	REC6R6-W0001-02-00	250-254
6K1-45945-01-98	SOL3572-153-19	403	6L5-45949-00-EL	PAF2.6-03010000	402	6R7-11181-A1	REC6R7-11181-A0	248-254
6K1-45947-00-98	SOL3512-148-17	403	6L5-45949-00-EL	SOL30111-073-05S	402	6S1-41136-00	REC6S1-41136-00	270
6K1-45947-00-98	SOL3514-145-17	403	6L5-45987-01	PAF4-03000025	345	6S1-85885-00	REC6S1-85885-00	90-102
6K1-45947-00-98	SOL3572-155-17	403	6L6-45371-00	TEN01103	164-169	6T4-45836-00	CM6T4-45836-00	159
6K1-45970-01-98	SOL3532-145-15	403	6L6-45371-00	TEN01103AL	164-169	6T4-45836-00	TEN01122	164
6K1-45972-01-98	SOL3532-140-21	403	6L8-G3118-01	REC6L8-G3118-01	134	6T5-45251-00	TEN01139	167
6K1-45974-02-98	SOL3532-140-19	403	6M6-14385-00	REC6H4-14985-01	100	6T5-45371-00	CM6T5-45371-00	161
6K1-45976-00-98	SOL3532-140-23	403	6N0-E1603-00	REC6G1-11610-00	223	6T5-45371-00	TEN01119	165
6K1-45978-02-98	SOL3532-143-17	403	6N0-G2177-00	REC6N0-G2177-00	134	6T5-45373-00	TEN01120	166
6K1-82510-06	REC6K1-82510-07	113	6N0-G5251-00	TEN01118	346	6T5-45373-00	CM6T5-45373-00	159
6K1-82570-13	REC6K1-82570-13	128	6N0-G5551-00	REC6N0-G5551-00	346-387	6U0-45251-00	TEN01157	165-169
6K4-11422-00	REC6K4-11422-00	256	6N0-G5551-A0	REC68T-45551-00	289	6U4-45251-00	CM6U4-45251-00	158-169
6K4-11432-00	REC6K4-11432-00	256	6N0-G5560-00	REC6N0-G5560-00	346-387	6U4-45251-00	TEN01159	167-169
6K4-11651-00	REC6K4-11651-00	260	6N0-G5571-00	REC6N0-G5571-00	346-387	6U4-45373-00	TEN01158	166-169
6K5-11601-02	REC6K5-11601-02	241-262-264-266	6N0-W0001-20	REC6G1-W0001-C1	346	6U0-45251-00	CM6U0-45251-00	159-169
6K5-11601-12	REC6K5-11601-12	241-262-264	6N0-W0078-A0	REC6G1-W0078-A1	150	6V3-45251-01	TEN01138	164
6K5-11601-22	REC6K5-11601-22	241-262-264	6N0-WG525-00	CM6G1-45251-03	159	6X2-85885-10	REC6X2-85885-10	103
6K5-11631-03-95	REC6K5-11631-03K	264-266	6N6-W0001-A3	REC6E5-W0001-A2	245	6Y1-24268-00	PAF15-10000003	76
6K5-11635-03	REC6K5-11635-03K	264	6N6-W0078-02	REC6N6-W0078-02	152	6Y1-24305-00	GS31075	76
6K5-11636-03	REC6K5-11636-03K	264	6N6-W0093-02	REC6N6-W0093-02	152-155-156-157	6Y1-24305-01	GS31075	76
6K5-11681-00	REC6K5-11681-00	261	6N7-11411-00	REC6N7-11411-00	97-245	6Y1-24305-02	GS31075	76
6K5-14301-03 +			6N7-81800-00	PH130-0051	245-256	6Y1-24305-05-00	GS31074	76
6K5-14302-03 +	REC6K5-14301-03	92-93	6N7-81800-01	PH130-0051	110	6Y1-24305-06-00	GS31075	76
6K5-14303-03			6N7-81800-10	PH130-0051	110	6Y1-24305-06-00	GS31074	76
6K5-45551-00	REC6K5-45551-00	388-390	6P2-11181-00	REC6P2-11181-00	213-216-218	6Y1-24305-06-00	GS31075	76
6K5-45560-00	REC6K5-45560-00	388-390	6P2-11182-00	REC6P2-11182-00	213-216-218	6Y1-24360-55-00	PAF15-09000000	74
6K5-45570-00	REC6K5-45570-00	390	6P2-11193-00	REC6P2-11193-00	213	6Y1-24360-52	GS31187	74



R.O. / OEM	REF		R.O. / OEM	REF		R.O. / OEM	REF	
6Y2-24305-06-00	GS31076	76	90105-16M67	PAT85-0000012	315-319	90201-10144	PAF25-05050018	201
6Y2-24360-52	GS31090	74	90109-06M65	PAF25-05050006	191-195-197-201-203-205-207	90201-10M01	PAGB/T96-10	293-349
6YJ-24167-00	PAF15-10000002	76	90109-08022	REC90109-08022	239-243-247	90201-10M01	REC90201-10M01	289-405
6YJ-24260-00	PAF15-10020000	76	90109-08M63	PAF25-05050019	193-199-207	90201-10M06	PAF25-05050018	193-199-207
6YJ-24260-10	PAF15-10020000	76	90109-08M71	REC90109-08M71	245	90201-11M49	PAF4-03000006	287-343
6YJ-24610-00	PAF15-10010000	75	90119-06M04	PAGB/T5783-M6X30	227	90201-12565	REC90201-12565	225-260
6YJ-24610-01	PAF15-10010000	75	90119-06M10	REC90119-06M10	325-329-333-377-385	90201-13198	PAF2.6-03000021	283
6YK-24305-01-00	GS31076	76	90119-06M40	PAGB/T5782-2000S	285	90201-13201	PAF15-07040017	180-185
6YL-24305-01-00	GS31074	76	90119-06M48	PAGB/T5783-M5X12	295	90201-15017	PAF15-06000020-1	293
6YL-24305-01-00	GS31075	76	90119-06M80-00	PAGB/T5783-M6X14	177	90201-15423	PAF20-05030011	189
703-48152-00	PAF15-13020007W	129	90119-06MA2	PAGB/T5783-M6X20	179-227	90201-16M00	REC90201-16M00	331-335-337-383
703-48205-10	PAT85-08010000W	126	90119-06MA3	PAF8-05000022	187	90201-17682	REC90201-17682	291-293-349-351
703-48205-10	REC703-48205-16	126	90119-06MA3	PAGB/T5783-M6X20	191	90201-17M00-00	REC90201-17M00	373
703-48205-12	REC703-48205-16	126	90119-06MA3	PAGB/T5783-M6X25	187-191-235	90201-20417	PAF25-04060007	295
703-48205-13	REC703-48205-16	126	90119-06MA4	PAGB/T5783-M6X30	235	90201-20417	REC90201-20417	233-235-239-241-243-260-261-353-355-357
703-48205-14	REC703-48205-16	126	90119-06MA5	PAGB/T5782-M6X35	191-203-205-233-241	90201-20M27	REC90201-20M27	229-260
703-48205-15	REC703-48205-16	126	90119-06MA5	PAGB/T5783-M6X25	191	90201-21M75	REC90201-21M75	245-247-261
703-48205-16	REC703-48205-16	126	90119-06MA5	PAGB/T5783-M6X35	243	90201-22008	PAT40-04050007	311
703-48205-17	REC703-48205-16	126	90119-06MAS	PAGB/T5783-M6X35	191	90201-22429	REC90201-22429	299-303-307-359-361-365-369
703-48205-18	REC703-48205-16	126	90119-08M01	PAGB/T5782-M8X80	191	90201-22M01	REC90201-22M01	325-329-333-377-381-385
703-48205-1A	REC703-48205-16	126	90119-08M13	REC90119-08M13	321-357-371	90201-23008	PAF2.6-04000003	173
703-48205-1B	REC703-48205-16	126	90119-08M14	REC90119-08M14	317-325-329-333-335-339-341-377-381-385-386	90201-23M01	REC90201-23M01	245-247-261
703-48205-21	REC703-48205-16	126	90119-08M15	REC90119-08M15	301-305-309-13-361	90201-266P2	PAF4-04000004	175
703-48230-10	PAF15-13000000W	126	90119-08M21	REC90119-08M21	231	90201-27M00	PAT40-04000008	301-305-309-313
703-48230-10	REC703-48230-14	126	90119-08M33	REC90119-08M33	317	90201-30M92	REC90201-30M92	323-327-375-379
703-48230-11	REC703-48230-14	126	90119-08M87	REC90119-08M87	321	90201-31M00	REC90201-31M00	331-383
703-48230-12	REC703-48230-14	126	90119-08MA5	PAGB/T5783-M6X25	235	90201-42014	REC90201-42014	339
703-48230-13	REC703-48230-14	126	90119-09M00	PAF25-05000002	191-197-207	90201-46M29	REC90201-46M29	227
703-48230-14	REC703-48230-14	126	90142-05M06	PAGB/T820-M5X30	299	90202-12060	PAF25-02000019	297-301-305-309-367-371
703-48230-15	REC703-48230-14	126	90149-06M00	REC90149-06M00	365	90204-11M49	PAF4-03000006	285-345
703-48230-16	REC703-48230-14	126	90151-05M05	PAGB/T820-M5X30	295	90206-22M19	REC90206-22M19	377-381-385
703-48230-17	REC703-48230-14	126	90152-05M00	REC90151-05M00	315-319	90208-04010	REC90282-04010	365
703-48230-18	REC703-48230-14	126	90152-05M03	PAGB/T820-M5X25	289	90209-18112	REC90209-18112	221-223-225-260
703-48230-1A	REC703-48230-14	126	90152-05M04	PAGB/T820-M5X25	350	90209-20M23	REC90209-20159	227-260
703-48230-20	REC703-48230-14	126	90152-05M06	PAGB/T820-M5X30	307-365	90209-24M03	REC90209-24M03	229-260-261
703-48230-21	REC703-48230-14	126	90170-012138	REC90170-12138	365	90209-27M07	REC90209-27M07	233-235-260-261
703-48245-00	PAF15-13010010W	130	90170-12138	REC90170-12138	299-303-307-311-359-361-369	90209-27M11	REC90209-27M11	261
703-48261-01	PAF15-13000500W	127	90170-16M01	REC90170-16M01	315-319-323-327-371-375-379	90214-48M03	REC90214-48M03	365-369
703-48272-12	PAF40-13000000E1	126	90170-16M01-00	REC90170-16M01-00	373	90250-03M10	REC90250-03M10	343
703-48293-10	PAF15-11000002W	129	90170-16M19	REC90170-16M19	331-335-337-383	90250-05010	REC90250-05010	291-293-295-349-351-353-355-357
703-48345-01	PAF25-07000007W	127	90170-16M19	REC90170-16M19	331-335-337-383	90250-05036	REC90250-05036	347
703-48861-11	PAT20-13000500W	1276	90170-20137	PAF25-05000026	195	90250-05046	REC90250-05046	345
703-82510-12	PAF15-13000200W	113	90170-28M37	PAF15-07030005	185	90250-06023	REC90250-06023	299-303-307-311-359-361-363-365-369
703-82510-43	REC703-82510-44	114	90170-30M03	PAF20-05000029	189	90250-07M02	REC90250-07M02	315-319-371
703-82563-00	PAE4-10040100W	122-128	90170-35M47	PAF25-05000026	193	90250-07M02-00	REC90250-07M02	373
703-82563-01	PAE4-10040100W	122-128	90171-10M01	PAF15-06000016	349	90250-08M07	REC90250-08M07	323-327-335-375-379
703-82563-02	PAE4-10040100W	128	90171-10M01	REC90171-10M01	289-291-293-405-351	90280-03017	PAGB/T1099-3X5X13	201
704-48205-11	REC704-48205-R0	127	90171-10M01	REC90171-10M01	295-353-355-357-405	90280-03024	PAF25-04000015	155-297
704-48205-12	REC704-48205-R0	127	90171-14013	REC90171-14013-00	299-303-307-311-315-319-359-361-365-369-371	90280-03024	REC90280-03024	154-155-156-309-313-346-347-349-357-359
704-48205-13	REC704-48205-R0	127	90171-16011	REC90171-16011	311-315-319-359-361-365-369-371	90280-03M01	PAGB/T1099-3X5X13	180-185-189-195-203-205
704-48205-14	REC704-48205-R0	127	90171-16011-00	REC90171-16011-00	373	90280-03M03	REC90280-03M03	154-156-301-305-317-355-361-369
704-48205-15	REC704-48205-R0	127	90171-18M04	REC90171-18M04	323-327-331-335-337-341-375-379-383-405	90280-04002	REC90280-04002	335
704-48205-B0	REC704-48205-R0	127	90179-08M06	REC90179-08M06	291-293-348-351	90280-04M00	REC90280-04M00	156-363-367
704-48205-B1	REC704-48205-R0	127	90179-09M02	REC90179-09M02	353	90280-04M04	REC90280-04M04	154-155-156-321-371
704-48205-P0	REC704-48205-R0	127	90179-10M14	REC90179-10M14	295-355-357	90280-04M04-00	REC90280-04M04	373
704-48205-P1	REC704-48205-R0	127	90183-02M03	REC90183-02M03	315-319-331-335-337-341-373-379-383-385	90280-04M05	REC90280-04M05	155-156-157-325-329-333-339-377-381-385-386
704-48205-R0	REC704-48205-R0	127	90185-05002	PAGB/T6182-M5	289-293-315-319-323-327-331-335-337-341-350	90280-04M06	PAF25-05000024	199
704-48207-20	REC704-48207-R0	127	90185-22043	PAGB/T889.1-2000	295	90280-04M06	PAF4-04000019	193-207
704-48207-21	REC704-48207-R0	127	90185-22M11	PAF15-01010007	131	90280-05049	REC90280-05049	229
704-48207-22	REC704-48207-R0	127	9020-14377	REC90201-14377	131	90282-04010	REC90282-04010	315-319-323-353-357-359-369-371-373-375
704-48207-30	REC704-48207-R0	127	90201-02M00	REC90201-02M00	227-260	90282-04M00	REC90282-04M00	327
704-48207-31	REC704-48207-R0	127	90201-06M94	PAGB/T5287-6	331-335-337-341-383	90304-08002	REC90340-08002	327-331-335-337-341
704-48207-39	REC704-48207-R0	127	90201-08784	PAF20-05030013	180-185			283-285-287-289-291-282-299-303-307-311-315-319-323-345-350-353-357-361-363-369-370-373-379-383
704-48207-P1	REC704-48207-R0	127	90201-08818	PAF4-04000006	177			
704-48207-R0	REC704-48207-R0	127	90201-08818	PAF4-04000006	64-66			
704-82570-08	REC704-82570-12	128	90201-08818	PAGB/T5783-M5X12	183			
704-82570-10	REC704-82570-12	128	90201-08818-00	PAF4-04000006	171			
704-82570-11	REC704-82570-12	128	90201-08M54	PAF4-03000026	283-285-287-345-405			
704-82570-12	REC704-82570-12	128						
7FK-12158-00	PA166F-010011	173-175-179						
7FK-12165-00	PA166F-010010	173-175-179						
7NJ-12117-00	PAF8-05030006	173-175						
7NJ-12118-00	PAF8-05030007	173-175-179						
90101-06M56	REC90101-06M56	353						
90101-08001	PAGB/T5783-M8X35	235						
90105-06035	PAGB/T5783-M6X35	189						
90105-06039	PAGB/T5783-M6X16	173						
90105-06M01	REC90105-06M01	363						
90105-06M14	PAGB/T5783-M6X16	175						
90105-06M25	PAGB/T5782-M6X45	175						
90105-08046-00	PAF4-04000033	175						
90105-081A7	PAGB/T5783-M8X25	189						
90105-08M36	PAF4-04000034	173-179-180						
90105-08M36-00	PAF4-04000034	175						
90105-08M76	PAF4-04000001	171						
90105-08M78	PAF15-07000028	180-185						
90105-090006	PAF20-05000002	187						
90105-10M00	PAT85-0000012	323-327-331-335-337-375-379						
90105-10								

R.O. / OEM	REF		R.O. / OEM	REF		R.O. / OEM	REF	
90340-08014	REC90340-08002	348-359			180-191-197-207-209-213-301-305-309-313-317-321-325	92995-06600	PAGB/T97.1-6	171-173-175-179-180-195-197-201-203-205-209-211-213-221-223-225-235-239-257-289-291-317-321-339-351-355
90340-08M04	REC90340-08002	295-343-347-365-375	90465-11M10	PAHT-2.5X60		92995-06600	PAGB/T97.1-8	185-227-229-233-241
90340-14M00	PAF15-04000002	237-241				92995-08600	PAGB/T97.1-8	179-209-214-325-329-333-335-337-341-343-363-369-377
		191-195-197-201-203-205-207-209-211-213	90465-11M10	PAHT2.5X50		92995-10100	PAGB/T97.1-10	299
90340-14M06	PAF15-04000002	203-205	90465-11M59	REC09401-11425		92995-10600	PAGB/T97.1-8	295-299-303-307-311-315-319-331
90344-51003	PAF15-07010004	351	90467-06016	PAHT-2.5X60		9306-306V5	REC93306-306V5	233-258
90381-14020	REC626-45316-09	133	90467-08004	PAF4-04000030		93101-10M14	PAF4-03000027	285-287
90381-20001	REC90381-20001	133	90467-08M01	PAF4-03000005		93101-10M14	REC93101-10M14	345
90386-10M16	PAT85-01010203	133	90467-09M09	PAF4-04000030		93101-10M25	REC93101-10M25	221
90386-18M35	PAT85-00000017	133	90467-13M13	PAF4-05000010		93101-11M23	REC93101-11M23	289-346
90386-18M63	REC90386-18M63	133	90472-00247	NGKB8HS-10		93101-12M70	REC93101-12M70	341
90386-22M13	REC90386-22M13	133	90480-06M19	PAF20-05000036		93101-13018	REC93101-13018	227
90386-22M15	PAF15-01010302	133	90480-10627	PAF20-05000034		93101-13M12	PAF4-03050002	283-285
90386-22M15	PAF25-01010002	133	90480-10M16	PAF15-07050003		93101-13M12	REC93101-13M12	287-345
90386-22M98	REC90386-22M98	133	90480-12072	PAF15-07010027		93101-13M27	REC93101-13M27	270
90386-25M31	REC90386-25M31	133	90480-18065	REC90480-18065		93101-14M01	REC93101-14M01	225
90386-30048	PAF15-01000004	133				93101-15074	REC93101-15074	289-346-347
90386-30M60	PAF15-01000006	133	90480-20M05	REC90480-20M05		93101-16001	REC93101-16001	229-233
90386-30M77	PAT85-01020005	133	90501-10064	PAF4-03030003		93101-17054	REC93101-17054	291-293-349-351
90386-30M77	REC90386-30M77	133	90501-10065	PAF25-04060002		93101-18050	REC93101-18050	347
90386-30M78	PAT85-01020003	133	90501-10M77	REC90501-10M77		93101-20001	REC93101-20048	292
90386-38M89	REC90386-38M89	133				93101-20048	REC93101-20048	291-349-351-363
90386-44M03	PAF25-01000004	133	90501-11M10	REC90501-11M10-00		93101-20M07	REC93101-20M07	295-353-355-357
90386-52M02	PAF25-01000001	133	90501-120A5	PAF20-05030007		93101-20M29	REC93101-20M29	221-225
90387-06119	REC624-42542-00	98	90501-12M40	PAF15-07040014		93101-20M34	REC93101-20M34	223
90387-06806	PAF4-00000001	285-287	90501-12M41	PAF15-07040013		93101-22067	REC93101-22067	353-355-359-365-367-369
90387-06M14	PAF4-00000001	345	90501-12M48	REC90501-12M48		93101-22067	REC93101-22M00	297
90387-06M69	PAF25-03000007	133	90501-14M02	REC90501-14M02		93101-22M00	REC93101-22M00	299-303-307-311-361-363
90387-13001	PAF15-07040009	185	90501-14M06	PAF15-06070002		93101-22M15	REC93101-22M15	245-247
90387-13002	PAF15-07040011	185	90501-150A0	PAF15-06070002		93101-22M60	REC93101-22M60	301-305-361
90387-13006	PAF20-05030006	189	90501-15M01	PAT40-04050002		93101-23070	REC93101-23070	317-357-359-369
90387-13M56	PAF15-07040012	180-185	90501-16233	REC90501-16233		93101-250-18	REC93101-25018	227
90387-32002	REC90387-32002	229	90501-16M01	REC90501-16M01		93101-25M03	REC93101-25M03	315-319-321-371
		299-303-307-311-361-365-405	90501-16M11	REC90501-16M11		93101-25M03-00	REC93101-25M03	373
90389-22M01	REC90389-22M01	315-319-371-405	90501-16M37	REC90501-16M37		93101-25M28	REC93101-25M35	231
		183-191-197	90501-16M37	REC90501-16M37		93101-25M57	REC93101-25M57	309-313
90401-20M00	PAF15-07010003	191-195-197-201-203-205-207	90501-18001	PAF60-04020002		93101-28M16	REC93101-28M16	325-329-333-335-339-377-381-385-386
90430-06014	PAF25-05050007	209-211-213-214-347-363-365	90501-450A2	REC90501-450A2		93101-300002	REC93101-30002	335-337
		214-347-363-365	90606-12019	REC93606-12019		93101-30M17	REC93101-30M17	323-327-331-375-379-383
90430-06M03	REC90430-06M03	292-303-307-311-315-323-283-285-287-289-291-299-327-331-335-337-341-343-345-346-347-348-350-353-355-357-359-361-363-365-369-370-375-379-383-386-64-65-66-67-68-69-70-71-72-73	907-94469-05	PAF40-0701000E		93101-30M33	REC93101-30M33	235
		292-303-307-311-315-323-283-285-287-289-291-299-327-331-335-337-341-343-345-346-347-348-350-353-355-357-359-361-363-365-369-370-375-379-383-386-64-65-66-67-68-69-70-71-72-73	907-94469-05	REC90794-46866		93102-10004	PAF4-04060004	177-179
90430-08003	REC90430-08020	292-303-307-311-315-323-283-285-287-289-291-299-327-331-335-337-341-343-345-346-347-348-350-353-355-357-359-361-363-365-369-370-375-379-383-386-64-65-66-67-68-69-70-71-72-73	907-94469-13	REC90794-46868		93102-15M32	REC93102-15M32	220
		292-303-307-311-315-323-283-285-287-289-291-299-327-331-335-337-341-343-345-346-347-348-350-353-355-357-359-361-363-365-369-370-375-379-383-386-64-65-66-67-68-69-70-71-72-73	90790-77001	GS35032		93102-18M21	PAF15-07040008	180-185
		292-303-307-311-315-323-283-285-287-289-291-299-327-331-335-337-341-343-345-346-347-348-350-353-355-357-359-361-363-365-369-370-375-379-383-386-64-65-66-67-68-69-70-71-72-73	90890-56878	GS35031		93102-20070	PAF2.6-04010001	171-177-179
90430-08020	REC90430-08020	315-319-371-405	91490-25030	PAGB/T91-1.6X12		93102-20108	PAGB/T97.1-8	183
		183-191-197	91490-30020	PAGB/T91-2.5X20		93102-20108	REC93102-20M25	223-225
		209-211-213-214-347-363-365	91490-30020	REC91490-30025		93102-22010	PAF20-05030005	189
		292-303-307-311-315-323-283-285-287-289-291-299-327-331-335-337-341-343-345-346-347-348-350-353-355-357-359-361-363-365-369-370-375-379-383-386-64-65-66-67-68-69-70-71-72-73	91490-30025	PAGB/T91-1.6X12		93102-23096	REC93102-23096	237
		292-303-307-311-315-323-283-285-287-289-291-299-327-331-335-337-341-343-345-346-347-348-350-353-355-357-359-361-363-365-369-370-375-379-383-386-64-65-66-67-68-69-70-71-72-73	91490-30025	REC91490-30025		93102-25008	REC93102-25008	229
		292-303-307-311-315-323-283-285-287-289-291-299-327-331-335-337-341-343-345-346-347-348-350-353-355-357-359-361-363-365-369-370-375-379-383-386-64-65-66-67-68-69-70-71-72-73	91490-30025	REC91490-30025		93102-25014	PAF15-07030006	189
		292-303-307-311-315-323-283-285-287-289-291-299-327-331-335-337-341-343-345-346-347-348-350-353-355-357-359-361-363-365-369-370-375-379-383-386-64-65-66-67-68-69-70-71-72-73	91490-30025	REC91490-30025		93102-25090	PAF4-04010004	177
		292-303-307-311-315-323-283-285-287-289-291-299-327-331-335-337-341-343-345-346-347-348-350-353-355-357-359-361-363-365-369-370-375-379-383-386-64-65-66-67-68-69-70-71-72-73	91490-30025	REC91490-30025		93102-25090	PAGB/T5783-M5X12	183
		292-303-307-311-315-323-283-285-287-289-291-299-327-331-335-337-341-343-345-346-347-348-350-353-355-357-359-361-363-365-369-370-375-379-383-386-64-65-66-67-68-69-70-71-72-73	91490-30025	REC91490-30025		93102-25M28	REC93102-25M28	237
		292-303-307-311-315-323-283-285-287-289-291-299-327-331-335-337-341-343-345-346-347-348-350-353-355-357-359-361-363-365-369-370-375-379-383-386-64-65-66-67-68-69-70-71-72-73	91490-30030	REC91490-30030		93102-25M48	REC93102-25M48	227
90430-08020-00	REC90430-08020	373	91490-30040	REC91490-30040		93102-25M52	PAF15-07030007	183
90430-08143	PAF4-04000006	197-209-211	91490-40025	REC91490-40025		93102-26M27	REC93102-26M27	231
90430-08800	PAF4-04000006	179				93102-28135	REC93102-28135	239
90430-08800-00	PAF4-04000006	175				93102-30M05	REC93102-30M05	243
90430-10M11	REC09168-12017	64-65	91490-40030	REC91490-40030		93102-30M23	REC93102-30M23	241
90430-12072	PAF25-02000005	297				93102-30M56	REC93102-30M56	233
90430-12072	REC90430-12072	301-305-309-361-367-371	91490-40030-00	REC91490-40030		93102-32M07	REC93102-32M07	229-239
90430-12072-00	REC90430-12072	373	91690-30010	PAGB/T879.4-3X20		93102-35M13	REC93102-35M13	245-247
		195-197-201-207-209-211-213-235-237-239-241	91810-03014	PAF15-07000001		93102-35M18	REC93102-35M18	235
90430-14115	PAF15-04000003	191	92-858026QB1	RM92-858026QB1U6		93102-35M47	PAF25-05020002	193-199
		65-66-67-68-69-70-71-72-73	92-858027QB1	RM92-858027QB1U3		93102-35M51	PAF15-07030006	183
90430-14M09	PAF15-04000003	191	92-8M0086220	RM92-8M0086220U6		93102-36M02	REC93102-36M02	243
		191	92-8M0086221	RM92-8M0086221U3		93102-36M24	REC93102-36M24	241
90430-14M09	PAF15-04000003	191	92885-06600	PAGB/T97.1-6		93102-37004	PAF25-05050021	189
		191	92903-06600	PAGB/T848-6				193-195-199-201-203-205-207
90445-07MA3	PAF2.6-04000015	237	92903-06600	PAGB/T97.1-6		93102-38008	REC93102-38008	211-213
90445-09061	PAF15-05000012	183	92907-04600	PAGB/T97.1-4		93102-38M59	REC93102-38008	209
90445-09068	PAF25-03000008	191-197-207	92955-08600-00	PAGB/T97.1-8				
90445-09086	PAF15-05000013	183	92990-06300	PAGB/T861.1-6				
90445-09095	PAF25-03000009	191-197-207	92990-06300	PAGB/T861.1-87				
90445-09104	PAF15-05000014	183-197-207	92990-06600	PAGB/T97.1-6				

R.O. / OEM	REF		R.O. / OEM	REF		R.O. / OEM	REF	
93102-40M14	REC93102-40M14	245-247	93210-59MG7	REC93210-59MG7	154-156-301-305-309-313-361	93311-636U6	REC93311-636U6	241-257-258
93102-43M42	PAF25-05020003	193-195-199-201-203-207	93210-60MA3	REC93210-60MA3	357	93311-83280	REC93311-83280	331-335-337-383-399-400
93102-48009	REC93102-48009	209	93210-62269	REC93210-62269	239-243	93311-832U4	REC93311-832U4	239-258
93102-60004	REC93102-60004	211	93210-64488	REC93210-64488	333-335	93311-85894	REC93311-85894	335
93102-63008	REC93102-63004	213	93210-64ME7	REC93210-64ME7	295-355	93311-928U5	REC93311-928U5	329-381-397-398-399-400
93103-09M41	PAF2.6-03000004	283	93210-65M50	REC93210-65M50	233-235-241-295-355	93311-940U3	REC93311-940U3	245-247-258-259
93103-10052	REC93103-10052	343	93210-66M98	REC93210-66M98	359-365-369	93311-940V0	REC93311-940V0	247
93103-11051	REC93103-11051	343	93210-69MG6	REC93210-69MG6	299-303-307-311-341-361	93314-314V8	REC93341-214U1	291
93104-16M01	REC93104-16M01	235-237	93210-74M35	REC93210-74M35	245-247	93315-017U4	REC93315-017U4	353-394-395
93104-16M04	REC93104-16M01	231	93210-74MG5	REC93210-74MG5	299-303-311-361	93315-217U0	REC93315-217U0	363-395
93104-18049	REC93104-18049	239	93210-85M97	REC93210-85M97	371	93315-22004	REC93315-22004	295-353-355-357-394-395
93104-20M02	REC93104-20M02	243	93210-85M97-00	REC93210-85M97	373	93315-220V7	PAGB/T290F-2020	297
93104-22M07	REC93104-22M07	335	93210-86M38	REC93210-86M38	155-156-157-325-329-333-339-377-381-385-386	93315-220V7	REC93315-220V7	355-357-394-395
93106-09014	REC93106-09014	305-309-313-317-321-325-329-333-335-339-369-371-377-381-385	93210-86M39	REC93210-86M39	315-319-323-375	93315-314V8	REC93315-314V8	291-292-351-393-394
93106-09014-00	REC93106-09014	373	93210-94003	REC93210-94003	335-341	93315-317U2	REC93315-317U2	291-293-349-351-393-394
93106-18M01	REC93106-18M01	241	93210-97M55	REC93210-97M55	327-379	93315-32224	REC93315-32224	301-305-309-313-359-361-367-369-394-395-396
93109-44M00	REC93109-44M00	132	93211-04001	REC93211-04001	245-247	93315-324U1	REC93315-324U1	363-395
93110-23M00	REC93110-23M00	227	93211-04384	REC93211-04384	331-337-383	93315-325V1	REC93315-325V1	371-394-395-396
93210-05001	PAF2.6-03000009	283	93304-205U0	REC93304-205U0	257	93315-325V1-00	REC93315-325V1	373
93210-06ME6	REC90430-08020	295	93306-001U1	REC93306-001U1	299-303-307-311-361-394-395-396	93315-425U7	REC93315-425U7	323-375-396-397
93210-06ME6	REC93210-06ME6	289-291-292-297-301-351-361	93306-004U0	PAGB/T276-6004C2	345	93315-425V3	REC93315-425V3	327-379-397-398-399-400
93210-07003	REC93210-07540	329	93306-004YH	PAGB/T276-6004C2	289	93315-43061	REC93315-43061	327-331-335-379-383-397-398-399-400
93210-09004	PAF2.6-04060002	171	93306-005019	REC93306-005019	291-293-349-351-393-394	93315-430U8	REC93315-430U8	323-375-396-397-398-399-400
93210-12MG9	PAF25-05050013	193-199-207-64-65-68-69-70-71-180-187-195-201-203-205	93306-00612	PAGB/T276-6006/P6	347-393	93315-430V5	REC93315-430V5	396-397-398-399-400
93210-13M63	PAGB/T3452.1-13X2	187-195-201-203-205	93306-00612	REC93306-00612	295	93315-628U9	REC93315-628U9	325-377-396-397-398
93210-14515	PAF25-05050014	193-199-207	93306-00702	REC93306-00702	353-355-357-394-395	93316-003Y0	PANTN16003EY	283
93210-19MJ1	REC93210-19MJ1	211-213	93306-20401	REC93306-204Y7	363	93317-22204	REC93317-22204	299-303-307-311-359-361-365-369-394-395-396
93210-22164	PAGB/T3452.1-25.8X2	355	93306-204U0	REC93306-204U0	221-223	93317-322V0	REC93317-322V0	315-319-396-397
93210-22M02	REC93210-22M02	235	93306-205B2	PANTN6205C3	179	93317-325U0	REC93317-325U0	315-319-371-396-397
93210-24M79	PAF4-04000008	177-180-185-201-203-205-64-65-69-70-171-181-187-191-195-197-207-209-211-213-214	93306-205U7	REC93306-205U7	257	93317-325U0-00	REC93317-325U0	373
93210-24M79	PAJASOF40431-025	211-213	93306-205YD	PAGB/T276-6004C2	177	93317-330U2	REC93317-330U2	325-329-333-359-377-381-385-396-397-398-399-400
93210-25552	REC93210-25552	297-355	93306-205YD	PAGB/T5783-M5X12	183	93332-00001	REC93332-00001	299-303-307-361-365-369-394-395-396
93210-26130	PAGB/T3452.1-25.8X2	297-355	93306-206U5	REC93306-206U5	243-258	93332-00003	REC93332-00003	394-395-396
93210-32738	PAGB/T3452.1-32.5X1.8	65-66-67-68-69-70-71	93306-207U0	REC93306-207U0	315-319-371-395-396-397	93332-00005	REC93332-00005	291-293-295-349-351-353-355-393-394-395
93210-32738	REC93210-32738	65-66-68-69	93306-207U0-00	REC93306-207U0	373	93332-00023	REC93332-00023	394-395-396
93210-33M49	PAJASOF404-19-033	335-339	93306-208U0	REC93306-208U0	245-247-258-259-323-375-393-397	93332-00048	REC93332-00048	327-331-397-398-399-400
93210-33M85	PAJASOF404-19-033	283	93306-209U0	REC93306-209U0	327-335-379-397-398-399-400	93332-00079	PAT40-04000027	367
93210-33M85	PAJASOF404-19-033	64-154	93306-209U1	REC93306-209U1	259	93332-00092	PAKOYOH1-CAP322/32	311
93210-33MG4	REC93210-33MG4	301-305-309-313-361	93306-210U0	REC93306-210U0	331-337-383-399-400	93332-000A5	REC93332-000A5	335
93210-33MH2	PAF25-05050015	193-199-207	93306-240U0	REC93306-240U0	225-257	93332-000U0	REC93332-000U0	363-395
93210-35537	PAF4-04060002	171-177	93306-272Y2	PAGB/T276-62/22/P6	171	93332-000U3	REC93332-000U3	317-321-371-396-397
93210-35537	PAGB/T345.2-D32.5XD1	179	93306-303V1	REC93306-306V1	235	93332-000U5	REC93332-000U5	373
93210-37160	REC93210-37160	325-329-333-335-339-341-377-381	93306-304U0	REC93306-304U0	257	93332-000U7	REC93332-000U7	323-375-396-397
93210-37M67	REC93210-37M67	385-386	93306-305-U8	REC93306-305U8	237-258	93332-000U8	REC93332-000U8	233-235-258
93210-41042	REC93210-41042	357-359-367-369	93306-305U10	REC93306-305U10	257-258	93332-000V3	REC93332-000V3	327-379-397-398-399-400
93210-42101	REC93210-42101	343	93306-305U3	REC93306-305U3	229-231-257-258	93332-000W1	REC93332-000W1	331-337-383-399-400
93210-42159	REC93210-42159	223-225-231-239	93306-306V1	REC93306-306V1	241-257-258	93332-000W5	PAH1-CAP32004JRKYOYO	297
93210-42M70	REC93210-42M70	225	93306-307U0	REC93306-307U0	233-235-258	93332-000W7	REC93332-000W7	371-394-395-396
93210-44398	PAJASOF404-31-045	351	93310-112V0	REC93310-112V0	221-223-257-262	93332-000W7-00	REC93332-000W7-00	373
93210-44398	REC93210-44398	154-155-289-291	93310-32337	REC93310-32337	247-265	93332-000WS	REC93332-000WS	355-394-395
93210-45161	PAF25-04050003	66-154-155-297-355	93310-32337	REC93310-32337	258-259	93340-67011	REC93340-67011	335-341
93210-45161	REC93210-45161	155	93310-323V6	REC93310-323V6	245	93341-214U1	REC93341-214U1	348-393-394
93210-46044	REC93210-46044	317-321-371	93310-32668	REC93310-32668	247	93341-41414	REC93341-41414	351-393-394
93210-46044-00	REC93210-46044	373	93310-326V4	REC93310-326V4	259	93341-93020	REC93341-93020	333-385
93210-46M16	REC93210-46M16	227-229-241-243	93310-418U0	REC93310-418U0	225-257	93341-930U9	REC93341-930U9	339
93210-48001	PAJASOF40424-050	313	93310-418V1	REC93310-418V1	221-223-257	93342-624U0	REC93342-624U0	363
93210-48214	PAJISB2401P48	283-285	93310-522W0	REC93310-522W0	257-258	93390-000U2	REC93390-000U2	397-398-399
93210-48214	REC93210-48214	287-341-345	93310-527W1	REC93310-527W1	258	93390-000U0	REC93390-000U0	363-395
93210-48MG8	REC93210-48MG8	301-309-361	93310-620V5	REC93310-620V5	227-257	93399-99951	REC93399-99951	229-257
93210-49046	REC93210-49046	154-289-293-317-321-346-359-369-371	93310-62406	REC93310-624U5	229-257-258	93420-22M03	PAGB/T893.1-22	287
93210-49046-00	REC93210-49046	373	93310-636U4	REC93310-636U4	243-258			
93210-53M08	REC93210-53M08	289-346	93310-727U0	REC93310-727U0	233-258			
93210-54534	REC93210-54534	333-339-385	93310-727V7	REC93310-727V7	235-258			
93210-54M54	REC93210-54M54	223	93310-730V6	REC93310-730V6	258			
93210-55M14	REC93210-54534	325-329-377-381	93310-730V8	REC93310-730V8	239-243-258			
93210-56M80	PAF15-06080003	231-291-293-351	93310-835U8	REC93310-835U8	243-258			
93210-57M00	REC93210-57M00	363	93310-836U0	REC93310-836U0	258-259			
93210-57M09	REC93210-57M09	291-293-349-351	93310-836V2	REC93310-836V2	245-247-258-259			
93210-58144	REC93210-58677	325-329-377-381	93310-954U1	REC93310-954U1	245-247-258-259			
93210-58677	REC93210-58677	347	93310-954V3	REC93310-954V3	258-259			
93210-58M21	REC93210-58M21	229-237	93311-632U1	REC93311-632U1	247			
			93311-632U2	REC93311-632U2	239-258			
			93311-632V4	REC93311-632V4	231-257			
					257-258			

R.O. / OEM	REF		R.O. / OEM	REF		R.O. / OEM	REF	
93430-06005	PAGB/T896-86	343	94702-00271-00	NGKBR7HS-10	108	97513-06525	PAGB/T5783-M6X25	185
93430-10M00	PAGB/T896-9	132	94702-00272	NGKBR7HS	221-233	97575-06520	PAGB/T5783-M6X20	293
93440-08819	PAF2.6-03000012	283	94702-00274	NGKBR6HS-10	64-65-180-223	97575-08530	PAGB/T5783-M8X30	293
93440-52008	REC93440-52009	227	94702-00274-00	NGKBR6HS-10	108	97575-08550-00	PAGB/T5783-M5X12	183
93440-68M03	REC93440-68M03	233-235	94702-00309	NGKBR9HS-10	245	97575-08550-00	PAGB/T5787-1986	177
93450-13022	REC93450-13022	221-223-225-262	94702-00372	NGKCR6HSB	64-173-179	97595-06520	PAGB/T5783-M6X20	185-187
93450-13130	PAF2.6-04020006	173	94702-00372-00	NGKCR6HS	108	97595-06520	PAGB/T97.1-8	183-191
93450-14088	PAF4-04020006	175-219	94702-00391	NGKLF5A-11	69-70-71-72-209-211	97595-06520	PAGB/T97.1-8	191-193-283
93450-15023	PAF15-07020005	183-219	94702-00391-00	NGKLF5A-11	108	97607-04210	PAGB/T818-M4X10	187
93450-15023	REC93450-15023	227-262	94702-00396	NGKBR8ES-11	108	97780-40112	PAGB/T845-ST4.2X16	349
93450-17129	PAF20-05020002	189-219	94702-00400	NGKLF6A-11	70-72-73-213-214	97780-50510	PAGB/T845-ST4.8X9	349
93450-17129	PAF25-05020106	193-195-199-201-203-205-207-219-231	94702-00400-00	NGKLF6A-11	108	97880-05025	PAGB/T818-M5X25	173-179-203-205
93501-04011	REC93501-04011	331-335-337-341-383	94702-00404-00	NGKBKR7EJU	108	97880-05025-00	PAGB/T818-M5X25	175
93503-16003	REC93503-16003	315-319-323-327-373-375-379	94702-00405-00	NGKBKR6EJU	108	98503-04066-00	PAGB/T818-M4X6	177
93507-32009	REC93507-32031	323-327	94702-00409	NGKCR9EB	108	98507-04010	PAGB/T818-M4X10	195-197-201-203-205-207
93507-32031	REC93507-32031	375-379	94702-00418	NGKDP6EB-9	65-66-67-68-69-187-195-201-203	98580-06016	PAGB/T818-M6X16	365
93511-32017	REC93511-32027	327	94702-00418-00	NGKDP6EB-9	108	98780-04015	PAGB/T820-M4X12	213-239
93511-32027	REC93511-32027	323-375-379	94702-00429-00	NGLKR7E	69-205	98780-04016	PAGB/T818-M5X12	187-209-237
93602-14104	REC93602-14104	227-257-262	94702-00437-00	NGLKR7E	108	98780-05016	PAGB/T818-M5X16	211
93602-14118	REC93602-14118	225-257-262	94702-00440	NGLKR6E	71-108	98980-05025	PAGB/T818-M5X25	187
93602-18M12	REC93602-18M12	229	947395-06040	NGLKR6E-9N	70	99001-06600	PAGB/T896-86	283-285-345
93602-20M02	REC93602-20M02	229-237-257-258-263-264-241-257-258-262-264	947395-06040	PAGB/T5782-M6X45	349	99001-06600	REC99001-06600	287-346
93603-18M09	REC93603-18M09	265	95380-05600	PAGB/T889.1-M5	299-303-307-311-365	99001-08600	REC99001-08600-00	305-309-313-317-321-325-329-333-335-339-369-371-377-381-385
93603-21111	REC93310-32337	265	95380-06700	REC95380-06700	301-361	99080-10600	PAGB/T896-9	132
93603-21111	REC93603-21111	233-235-239-243-258-259-263-264-265	95817-06012	PAGB/T5783-M6X12	171	99510-10114	PAF15-07000001	180-183-185
93604-07M13	PAF2.6-03000013	64-154-283	95895-06012	PAGB/T5783-M6X12	177	99510-10114	PAF4-04000003	175-177-179
93604-08062	PAF25-04000007	214-223-239-301-305-309-313-349-357-363-367	95895-06012	PAGB/T5783-M6X14	287	99530-08012	PAF25-00000014	191-197-201-203-205-207
93604-09066	PAF4-03000016	64-154-285-287-345	95895-06016	PAGB/T5783-M6X35	343-347	99590-10114	REC99590-10114	337-383
93604-09068	PAF2.6-03000013	343	95895-06016	PAGB/T5783-M5X12	287-289	99999-02808	REC99999-02808	134
93604-10M03	PAF15-00000013	201-317-351	95895-06016-00	PAGB/T5783-M5X12	285	99999-03116	PAF15-01010301S	131
93604-10M03	PAF25-04000007	195-203-205-297-321-355-371	95895-06020	PAGB/T5783-M5X12	283	99999-03249	PH130-0007	111
93604-12M07	PAF15-00000013	171-173-283-289-291-293-351	95895-06035	PAGB/T5783-M6X125	295	99999-03938	PH130-0051	110
93604-12M07	PAF15-07000013	183	95895-06035	PAGB/T5783-M6X30	293	CS3-43880-00	PH200-T036	122
93604-18080	PAF4-03000013	283-285-287-345	970-95-06030	PAGB/T5783-M6X30	231	F5-85570-13	REC6F5-85570-11	105
93605-14143	PAF25-05050016	193-199-207	97013-05010	PAGB/T5783-M5X10	179	JA9-12153-00	PA166F-000001	173-175-179
93606-11M24	REC93606-12019	297	97013-06012	PAGB/T5783-M6X12	189	K0A-A3721-00	RECK0A-A3721-00	209
		187-195-201-203-207-209-211-213-214-221-227-229-231-237-299-303-307-311-315-319-325-329-333-335-339-341-349-367-371-377-381-385	97013-06035	PAF15-07000030	197	K0A-A3722-00	RECK0A-A3722-00	209
			97013-06035	PAGB/T5782-M6X125	193	MAR-24563-00	RACS3213	78
			97013-06040	PAGB/T5782-M6X125	285	MAR-6YT30-02-12	SOL3231-101-13	402
			97013-06045	PAF20-05010007	187	N26-13440-00	REC26-13440-00	83-214
			97075-08025	PAGB/T5783-M5X12	171	N26-13440-02	REC26-13440-00	73-83
			97075-08035	PAGB/T5783-M8X25	209	N51-11325-01	TEN01160T	167
			97075-08035	PAGB/T5783-M8X35	289	YMD-63021-01	REC2TU3	84
			97075-10040	REC97075-10040	299-303-307-311-319-369-370	YMD-63021-04	REC2TU3	84
			97080-08025	PAGB/T5783-M8X25	289-291-292-351	YMD-63050-01	REC10W30U6	84
			97080-08045	REC97080-08045	289-291-351	YMD-63050-04	REC10W30U3	84
			97090-06014	PAGB/T5783-M6X16	343	YMD-63060-01	REC10W40U6	84
			97095-05012	PAGB/T5783-M5X12	191	YMD-63060-04	REC10W40U3	84
			97095-05012	PAGB/T818-M5X12	197-203-205-207	YMD-RCBOX-00-10	GS40015	127
			97095-05016	PAGB/T5783-M5X16	343	YMM-21005-00-00	PRE3300C05	130
			97095-0512	PAGB/T5783-M5X12	183	YMM-21006-C8-00	PRE3300C06	130
			97095-06010	PAGB/T5783-M6X10	197-349-363	YMM-21007-C8-00	PRE3300C07	130
			97095-06016	PAGB/T5783-M6X16	221-223-225-227-231-235-239-321-339	YMM-21008-C8-00	PRE3300C08	130
			97095-06016	PAGB/T97.1-6	371	YMM-21009-C8-00	PRE3300C09	130
			97095-06020	PAGB/T5783-M6X20	171-173-179-180-191-195-197-201-203-205-207-209-213-233-237-241-291-347-351	YMM-21010-C8-00	PRE3300C10	130
			97095-06020-00	PAGB/T5783-M6X20	175	YMM-21011-C8-00	PRE3300C11	130
			97095-06025	PAGB/T5782-M6X25	209-213-231	YMM-21012-C8-00	PRE3300C12	130
			97095-06030	PAGB/T5783-M6X30	180-211-213-343-346	YMM-21013-C8-00	PRE3300C13	130
			97095-06030	REC90101-06M56	209	YMM-21014-C8-00	PRE3300C14	130
			97095-06035	PAGB/T5783-M5X12	185	YMM-21015-C8-00	PRE3300C15	130
			97095-06040	REC97095-06040	347-355	YMM-21016-C8-00	PRE3300C16	130
			97095-06045	REC97095-06045	211-287-346	YMM-21017-C8-00	PRE3300C17	130
			97095-08014	PAGB/T5783-M8X14	171-179	YMM-21018-C8-00	PRE3300C18	130
			97095-08014-00	PAGB/T5783-M8X14	175	YMM-21019-C8-00	PRE3300C19	130
			97095-08020	PAF4-04000001	331-335-337-341	YMM-21020-C8-00	PRE3300C20	130
			97095-08020	PAGB/T5783-M8X20	179	YMM-21021-C8-00	PRE3300C21	130
			97095-08020-00	PAF4-04000001	177	YMM-21022-C8-00	PRE3300C22	130
			97095-08020-00	PAGB/T5783-M8X20	177	YMM-21023-C8-00	PRE3300C23	130
			97095-08025	PAGB/T5783-M8X25	299-303-307-311-325-329-333-339	YMM-21024-C8-00	PRE3300C24	130
			97095-08035	PAGB/T5783-M8X35	303-307-311	YMM-21025-C8-00	PRE3300C25	130
			97095-08045	REC97095-08045	293-363-367-369	YMM-21026-C8-00	PRE3300C26	130
			97095-08055	REC97095-08055	363-367-369	YMM-21027-C8-00	PRE3300C27	130
			97395-06020	PAGB/T5783-M6X20	349	YMM-21028-C8-00	PRE3300C28	130
			97395-08045	REC97095-08045	359	YMM-21029-C8-00	PRE3300C29	130
			97395-08055	REC97095-08055	359	YMM-21030-C8-00	PRE3300C30	130
			97395-08070-00	REC97395-08070	373	YMM-2E114-00	RACS3240	79
						YMM-2E227-00	RACS3227	79
						YMM-2E227-01	RACS3227	79
						YMM-2FE08-00	GS31166	79
						YMM-2FE10-00	GS31065	79
						YMM-2FS08-00	GS31066	79
						YMM-2FS10-00	GS31067	79
						YMM-2W114-00	RAC120R-RAC-01	79
						YMM-2W227-01	RAC320R-RAC-01	78
						YMM-2W227-01	RAC490R-RAC-01	79

# SUZUKI

ES

<b>GUÍA MANTENIMIENTO COLAS Y Y KITS</b>	439	CLIP	466	<b>PISTONES</b>	492
<b>SISTEMA DE ALIMENTACIÓN Y FILTRACIÓN</b>	442	CONECTORES CABLES	466	KIT DE PISTONES	492
<b>ACEITE</b>	450	DIRECCIÓN HIDRÁULICA	467	<b>RETENES DE ACEITE</b>	488
<b>BOMBA DE COMBUSTIBLE EN LÍNEA</b>	442	PLACA CERRADURA SELECTOR	466	JUNTAS TAPÓN DRENAJE	490
ABRAZADERA PARA MANGUERA	443	<b>INTERRUPTORES PARA MANDOS</b>	465	<b>SISTEMA DE ESCAPE Y ADMISIÓN</b>	493
ADAPTADOR LÍNEA DE COMBUSTIBLE	443	INTERRUPTOR PANEL COMPLETO O DOBLE ESTACIÓN	465	<b>SISTEMA DE ADMISIÓN 4 TIEMPOS</b>	494
BOMBA DE COMBUSTIBLE	442	INTERRUPTOR PANEL SIMPLE	465	JUNTAS DE COLECTOR	494
LÍNEA DE COMBUSTIBLE	442	<b>MANDOS DE CONTROL</b>	464	JUNTAS TAPA DE ESCAPE	494
MANGUERA DE COMBUSTIBLE	442	MANDO LATERAL	464	<b>SISTEMA DE ESCAPE 4 TIEMPOS</b>	493
MUELLE TUBO COMBUSTIBLE	443	MANDO PARA CONSOLA	465	JUNTAS CARTER	493
<b>BOMBA DE COMBUSTIBLE</b>	450	<b>SISTEMA DE REFRIGERACIÓN</b>	468	JUNTAS DE COLECTOR	493
BOMBA DE COMBUSTIBLE ELÉCTRICA	450	<b>ÁNODOS</b>	476	JUNTAS MÚLTIPLE DE ESCAPE	493
BOMBA DE COMBUSTIBLE MECÁNICA	450	ÁNODO CANADA METAL	476	<b>SISTEMA DE ESCAPE 2 TIEMPOS</b>	495
JUNTAS VST	451	ÁNODO TECNOSEAL	478	JUNTAS DE ESCAPE	495
KITS MEMBRANAS Y JUNTAS	451	KITS DE ÁNODOS CANADA METAL	476	JUNTAS TAPA DE ESCAPE	495
<b>CARBURADOR</b>	453	TORNILLO INOX	479	JUNTAS TUBO DE ESCAPE	495
BOYAS	453	JUNTAS TAPA DEL ÁNODO	479	<b>UNIDADES DE TRANSMISIÓN</b>	496
CARBURADOR COMPLETO	453	JUNTAS TÓRICA	479	<b>DESPIECE COLAS 4 TIEMPOS</b>	496
KITS CARBURADORES	453	<b>BOMBA DE AGUA</b>	471	DF4 • DF5 • DF6	496
<b>COMPONENTES TANQUE Y CONECTORES</b>	443	CASQUILLO INOX	472	DF8 • DF9.9 • DF15 • DF20	498
CONECTOR DE DEPÓSITO	443	CUERPO BOMBA DE AGUA	471	DF20 • DF25	504
PASAMAMPAROS	444	GUÍA KITS BOMBA DE AGUA	476	DF30	506
<b>FILTRO DE ACEITE</b>	449	JUNTAS BOMBA	473	DF40 • DF50	508
GUÍA FILTROS DE ACEITE	449	JUNTAS BASE DE BOMBA	472	DF60	510
JUNTA TAPÓN DE CARTER	449	JUNTAS TÓRICA BOMBA DE AGUA	472	DF70	512
<b>FILTRO DE COMBUSTIBLE Y ELEMENTOS</b>	445	KITS DE REPARACIÓN BOMBA DE AGUA	474	DF80 • DF90 • DF100	513
BRACKET	445	TAPA DE LA BOMBA	472	DF115 • DF140	514
FILTRO DECANTADOR DE COMBUSTIBLE COMPLETO CON VASO TRASPARENTE	445	<b>IMPULSORES</b>	469	DF150 • DF175 • DF200 • DF225 • DF250	517
FILTRO COMBUSTIBLE ALTA PRESIÓN	448	CHAVETA	470	DF300	519
FILTRO DECANTADOR DE GASOLINA	446	GUÍA IMPULSORES	469	<b>COMPONENTES DE COLA</b>	519
FILTRO COMBUSTIBLE MONTAJE EN LÍNEA	447	TAPA DEL IMPULSOR	471	ARO TÓRICO DEL DIÁBOLO	521
FILTRO COMBUSTIBLE SEPARADOR AGUA	445	<b>TERMOSTATO</b>	468	ARO TÓRICO, VARILLA DE CAMBIO	520
LLAVES PARA FILTRO	447	TAPÓN DE AGUA	469	DIÁBOLO	521
RACOR DE LATÓN	447	TERMOSTATO	468	FUELLES VARILLA DE CAMBIO	520
<b>INYECTORES</b>	451	<b>PARTES DEL MOTOR</b>	480	GUÍA KITS DE JUNTAS	520
GUÍA INYECTORES Y SENSORES	452	<b>ÁRBOL DE LEVAS</b>	483	KITS JUNTAS Y RETENES	519
<b>SISTEMA ELÉCTRICO</b>	454	<b>CIGÜEÑAL</b>	490	TORNILLOS Y JUNTAS DE DRENAJE	521
<b>BOBINAS</b>	455	ARANDELAS DE BIELA	491	TUBO DRENAJE BOMBA DE AGUA	521
REGULADOR-BOBINA	455	BIELAS	491	TUERCA VARILLA DE CAMBIO	520
<b>BUJÍAS</b>	455	PARTES CIGÜEÑAL	490	<b>SELECTOR</b>	522
<b>CDI Y CAJAS NEGRAS</b>	460	RODAMIENTOS	490	EXTREMO PARA SELECTOR	523
<b>DESCONECTORES DE SEGURIDAD</b>	460	RODAMIENTOS DE BIELA	491	MUELLE APRA SELECTOR	522
KITS	461	<b>DESPIECE MOTOR DE 4 TIEMPOS</b>	481	PASADOR PARA SELECTOR	522
<b>LLAVES DE ARRANQUE</b>	458	DF40 • DF50	481	PIN	522
<b>MOTORES DE ARRANQUE</b>	457	DF70 • DF80 • DF90 • DF100	482	VARILLA PARA SELECTOR	523
SOLENOIDE PARA MOTOR DE ARRANQUE	458	<b>DESPIECE MOTOR DE 2 TIEMPOS</b>	480	<b>RODAMIENTOS</b>	523
<b>REGULADORES Y RECTIFICADORES</b>	458	DT40 • DTW	480	ARANDELA / GRUESOS	526
GUÍA REGULADORES Y RECTIFICADORES	459	<b>GUÍA CORREAS DE DISTRIBUCIÓN</b>	492	BOMBA DE ACEITE	523
<b>RELÉ</b>	460	<b>JUNTAS DE MOTOR 4 TIEMPOS</b>	483	BOMBA DE AGUA	523
RELÉ EMC	460	GUÍA JUNTAS DE CULATA	484	CIRCLIP BOMBA AGUA	524
<b>SENSORES</b>	454	JUNTAS BASE ACEITE	485	DIÁBOLO	524
SENSOR CMP	454	JUNTAS BASE DE MOTOR	484	EJE TRANSMISIÓN INFERIOR	524
SENSOR IAC	454	JUNTAS BASE RETÉN	485	EJE TRANSMISIÓN SUPERIOR	524
SENSOR MAP	454	JUNTAS CUERPO DE MARIPOSA	485	PIÑÓN DE ATAQUE	525
<b>TRIM, TILT &amp; POWER TRIM</b>	461	JUNTAS DE ACEITE	485	PIÑÓN MARCHA ATRÁS	526
EXTRACTOR TAPONES DE TRIM	463	JUNTAS DE CULATA	483	PIÑÓN MARCHA AVANTE	525
INSTALACIÓN ELÉCTRICA	461	JUNTAS GUÍA CADENA	485	<b>SISTEMA DE PROPULSIÓN</b>	527
POWER TRIM COMPLETO	462	JUNTAS RETÉN SUPERIOR	486	<b>HÉLICES ALUMINIO E INOXIDABLE DE 3 Y 4 PALAS</b>	527
SENSORES DE TRIM	463	JUNTAS TAPA DE BALANCINES	486	GUÍA HÉLICES CON NÚCLEO INTEGRADO	528
TAPONES DE TRIM	463	JUNTAS TAPA DE FILTRO	485	GUÍA PIEZAS DE COLA	531
TRIM COMPLETO	461	JUNTAS TAPA DE TERMOSTATO	486	HÉLICES PARA NÚCLEO INTERCAMBIABLE	530
<b>SISTEMA DE GOBIERNO</b>	464	JUNTAS TAPA DE SILENBLOCK	486	KIT CIERRE DE HÉLICE	531
<b>ARNÉS</b>	466	JUNTAS VÁLVULA DE PRESIÓN	486	NÚCLEO INTERCAMBIABLE	529
EXTENSIÓN ARNÉS SISTEMAS ANALÓGICOS	466	KIT JUNTAS DE CULATA	484	PASADOR DE HÉLICE	532
<b>COMPONENTES</b>	466	<b>JUNTAS DE MOTOR 2 TIEMPOS</b>	487	PASADOR DE LA TUERCA DE HÉLICE	532
CABLES DE ACELERADOR	467	GUÍA JUNTAS DE CULATA	487	SEPARADOR DE HÉLICE	532
CABLES DE CONTROL	467	JUNTAS BASE DE ACEITE	488	TUERCA DE HÉLICE	532
CASQUILLO BASCULANTE	466	JUNTAS DE CULATA	487	REF --> RO	533
		JUNTAS DE CULATÍN	488	RO --> REF	538
		JUNTA TAPA DE TERMOSTATO	488		

SUZUKI

RECAMBIOS MARINOS

<b>DRIVES MAINTENANCE GUIDE &amp; KITS</b>	439	<b>ENGINE CONTROLS</b>	464	GASKET, EXHAUST COVER	495
<b>FUEL &amp; FILTRATION SYSTEM</b>	442	CONSOLE CONTROL	465	GASKET, EXHAUST TUBE	495
<b>CARBURATOR</b>	453	SIDE CONTROL	464	<b>INTAKE SYSTEM 4 STROKES</b>	494
CARBURETOR KITS	453	<b>SWITCHES FOR ENGINE CONTROLS</b>	465	GASKETS, COLLECTOR	494
FLOATS	453	PANEL TWIN STATION	465	GASKETS, EXHAUST COVER	494
FULL CARBURATOR	453	SWITCH	465	<b>UNIT DRIVES &amp; COMPONENTS</b>	496
<b>FUEL FILTERS AND ELEMENTS</b>	445	<b>COOLING SYSTEM</b>	468	<b>BEARING</b>	523
BRACKET	445	<b>ANODES</b>	476	CLIP	524
COMPLET FUEL FILTER	446	ANODES CANADA METAL	476	DIABOLO	524
COMPLET FUEL FILTER WITH TRANSPARENT BOWL	445	ANODES KIT	477	INITIATIVE GEAR	525
FILTER KEY	447	ANODES TECNOSEAL	478	LOWER, DRIVE SHAFT	524
HIGH PRESSURE FUEL FILTER	448	GASKET, ANDOE COVER	479	OIL PUMP	523
IN-LINE FUEL FILTER	447	O-RING	479	POSITIVE GEAR	525
RACORS	447	SS SCREW	479	REVERSE GEAR	526
WATER SEPARATING FUEL FILTER	445	<b>IMPELLERS</b>	469	UPPER, DRIVE SHAFT	524
<b>FUEL PUMP</b>	450	IMPELLERS GUIDE	469	WASHER / SHIM	526
DIAPHRAGMS & GASKETS	451	IMPELLER PLATE	471	WATER PUMP	523
FUEL PUMP ELECTRIC	450	KEY	470	<b>CLUTCH DOGS</b>	522
FUEL PUMP MECHANICAL	450	<b>THERMOSTAT</b>	468	ARM, CLUTCH	523
VST GASKETS	451	WATER FLUSH PLUG	469	CLUTCH DOGS	522
<b>FUEL PUMP IN LINE</b>	442	<b>WATER PUMP</b>	471	CLUTCH PIN	522
CLAMP SMALL	443	COVER	472	PIN	522
COUPLER	443	GASKET	473	ROD PUSH	523
FUEL HOSE	442	GASKET BASE	472	SPRING CLUTCH	522
FUEL LINE ASSEMBLY	442	GUIDE, SERVICE KIT	476	<b>DRIVE COMPONENTS</b>	519
FUEL PUMP	442	HOUSING	471	DIABOLO, O-RING	521
SPRING, FUEL PIPE	443	INSERT CUP	473	DRAIN EATER TUBE	521
<b>FUEL TANK COMPONENTS &amp; CONNECTORS</b>	443	O-RING	472	DRAIN, SCREW AND GASKETS	521
TANK CONNECTOR	443	SERVICE KIT	474	GUIDE OF GASKETS KITS	520
THRU HULL	444	<b>ENGINE PARTS</b>	480	SEAL KITS	519
<b>INJEKTOR</b>	451	<b>CAMSHAFT</b>	483	SHIFT, BELOW	520
GUIDE INJECTORS & SENDERS	452	<b>CRANKSHAFT</b>	490	SHIFT, O-RING	520
<b>OIL</b>	450	CRANKSHAFT BEARINGS	490	TURNBUCKE, CLUTCH ROD	520
<b>OIL FILTER</b>	449	CRANKSHAFT PARTS	490	<b>GEAR CASE PARTS 4 STROKES</b>	496
OIL DRAIN PLUG GASKET	449	CONNECTING ROD	491	DF4 • DF5 • DF6	496
OIL FILTER GUIDE	449	CONNECTING ROD, BEARINGS	491	DF8 • DF9.9 • DF15 • DF20	498
<b>ELECTRIC SYSTEM</b>	454	CONNECTING ROD, THRUST WASHER	491	DF20 • DF25	504
<b>CDI &amp; POWER PACK</b>	460	<b>ENGINE GASKETS 4 STROKES</b>	483	DF30	506
<b>COILS</b>	455	GASKET	484	DF40 • DF50	508
COIL	455	GASKET, CYLINDER COVER	486	DF60	510
REGULATOR-COIL	455	GASKET, CYLINDER HEAD	483	DF70	512
<b>CUT OFF SWITCHES</b>	460	GASKET, FILTER COVER	485	DF80 • DF90 • DF100	513
KIT	461	GASKET KIT, CYLINDER HEAD	484	DF115 • DF140	514
<b>IGNITION STARTER SWITCH</b>	458	GASKET, MOUNT OIL SEAL COVER	485	DF150 • DF175 • DF200 • DF225 • DF250	517
<b>REGULATOR AND RECTIFIERS</b>	458	GASKET, OIL GALLERY	485	DF300	518
REGULATORS AND RECTIFIERS GUIDE	459	GASKET, PRESSURE VALVE	486	<b>PROPULSION SYSTEM</b>	527
<b>RELAY</b>	460	GASKET, SILEMLOCK COVER	486	<b>3 &amp; 4 BLADE ALUMINIUM &amp; SS PROPELLERS</b>	527
<b>SENSORS</b>	454	GASKET, THERMOSTAT COVER	486	COTTER PIN	532
SENSOR, CMP	454	GASKET, THROTTLE BODY	485	INTERCHANGEABLE HUB	529
SENSOR, IAC	454	GASKET, TIMING CHAIN GUIDE BASE	485	PROPELLERS APPLICATION WITH RUBBER HUB	528
SENSOR, MAP	454	GASKET, UNDER OIL	485	PROPELLERS FOR INTERCHANGEABLE HUB	530
<b>SPARK</b>	455	GASKET, UPPER SEAL	486	PROPELLER PIN	532
<b>STARTERS</b>	457	<b>ENGINE GASKET 2 STROKES</b>	487	PROPELLER NUT	532
SOLENOID FOR STARTER	458	CYLINDER HEAD GASKET	487	PROPELLER NUT KIT	531
<b>STARTERS</b>	457	CYLINDER HEAD GASKET GUIDA	487	PROPELLER WASHER	532
<b>TRIM, TILT &amp; POWER TRIM</b>	461	GASKET, HEAD COVER	488	STERN DRIVE COMPONENTS, APPLICATION	531
COMPLETE POWER TRIM ASSEMBLY	462	GASKET, THERMOSTAT COVER	488	REF --> OEM	533
COMPLETE TRIM ASSEMBLY	461	GASKET, UNDER OIL	488	OEM --> REF	538
TRIM CAP	463	<b>ENGINE PARTS 2 STROKES</b>	480		
TRIM PLUGS EXTRACTOR	463	DT40 • DTW	480		
TRIM SENSORS	463	<b>ENGINE PARTS 4 STROKES</b>	481		
WIRING HARNESS	461	DF40 • DF50	481		
<b>STEERING SYSTEM</b>	464	DF70 • DF80 • DF90 • DF100	482		
<b>ARNES</b>	466	<b>GUIDE TIMING BELT</b>	492		
ARNES EXTENSION ANALOGIC SYSTEM	466	<b>PISTONS</b>	492		
<b>COMPONENTS</b>	466	PISTON KITS	492		
BLOCK CONTROL HANDLE	466	<b>OIL SEALS</b>	488		
BUSH SWIVEL	466	OIL SEALS	488		
CABLE CONNECTOR	466	O-RING DRAIN CAP	490		
CLIP	466	<b>EXHAUST &amp; INTAKE SYSTEM</b>	493		
CONTROL CABLES	467	<b>EXHAUST SYSTEM 4 STROKES</b>	493		
HYDRAULIC STEERING	467	GASKET, COLLECTOR	493		
THROTTLE THROTTLE	467	OIL PAN, GASKET	493		
		MULTI-EXHAUST GASKET	493		
		<b>EXHAUST SYSTEM 2 STROKES</b>	495		
		GASKET, EXHAUST	495		

GUIDA MANUTENZIONE E KIT	439	CLIP	466	<b>SISTEMA DI SCARICO E ASPIRAZIONE</b>	493
<b>SISTEMA DI ALIMENTAZIONE E FILTRAZIONE</b>	442	PLACCA SERRATURA SELETTORE	466	<b>SISTEMA ASPIRAZIONE 4 TEMPI</b>	494
CARBURATORE	453	TAPO GIREVOLE	466	GUARNIZIONE COLLETTORE	494
CARBURATORE COMPLETO	453	TIMONERIA IDRAULICA	467	GUARNIZIONE COPERCHIO SCARICO	494
GALLEGGIANTE	453	<b>INTERRUTTORI PER CONTROLLO</b>	465	<b>SISTEMA SCARICO 4 TEMPI</b>	493
KIT CARBURATORI	453	INTERRUTTORE PANNELLO SINGOLO	465	GUARNIZIONE CARTER	493
<b>COMPONENTI SERBATOIO E CONNETTORI</b>	443	PANNELLO DOPPIA STAZIONE	465	GUARNIZIONE COLLETTORE	493
ATTACCO SERBATOIO	443	<b>SISTEMA DI RAFFREDDAMENTO</b>	468	GUARNIZIONE SCARICO MULTIPLO	493
PASSASCAFO	444	<b>ANODI</b>	476	<b>SISTEMA SCARICO 2 TEMPI</b>	495
<b>FILTRI BENZINA E RACCORDI</b>	445	ANODI CANADA METAL	476	GUARNIZIONE COPERTURA SCARICO	495
CHIAVE DA FILTRO	447	ANODI TECNOSEAL	478	GUARNIZIONE SCARICO	495
FILTRO BENZINA ALTA PRESSIONE	448	KIT ANODI	477	GUARNIZIONE TUBO SCARICO	495
FILTRO BENZINA PER MONTARE IN LINEA	447	GUARNIZIONE COPERCHIO ANODO	479	<b>UNITÀ DI TRASMISSIONE</b>	496
FILTRO DECANATORE BENZINA	446	O-RING	479	<b>COMPONENTI PIEDI</b>	519
FILTRO DI DECANAZIONE BENZINA	445	VITE INOS	479	DADO ASTA CAMBIO	520
FILTRO SEPARATORE ACQUA-BENZINA	445	<b>GIRANTE</b>	469	DIABOLO	521
RACCORDI	447	CHIAVETTA	470	GUIDA KIT GUARNIZIONE	520
SUPPORTO	445	COPERCHIO GIRANTE	471	KIT GUARNIZIONE E TENUTE	519
<b>FILTRO OLIO</b>	449	GUIDA GIRANTE	469	MANICOTTO MARCE	520
GUIDA FILTRO OLIO	449	<b>POMPA ACQUA</b>	471	O-RING DIAVOLO	521
GUARNIZIONE, TAPO COPPA L'OLIO	449	GHIERA INOX	473	O-RING MARCE	520
<b>INIETTORE</b>	451	GUIDA KIT POMPA ACQUA	476	TUBO DRENAGGIO ACQUA	521
INIETTORE	451	COPERCHIO POMPA	472	VITI E GUARNIZIONE DRENAGGIO	521
GUIDA INIETTORI E SENSORI	452	CORPO, POMPA ACQUA	471	<b>CUSCINETTO</b>	523
<b>OLIO</b>	450	GUARNIZIONE BASE POMPA	472	DIABOLO	524
<b>POMPA BENZINA</b>	450	GUARNIZIONE POMPA	472	CERCLIP	524
ADATTATORE	443	KIT RICAMBI POMPA ACQUA	474	INFERIORE, ALBERO DI TRASMISSIONE	524
FASCETTE	443	<b>TERMOSTATO</b>	468	PIGNONE ATTACCO	525
GUARNIZIONE VST	451	TAPPO ACQUA	469	PIGNONE MARCIA AVANTI	525
MEMBRANA E GUARNIZIONI	451	<b>PARTI MOTORE</b>	480	PIGNONE MARCIA INDIETRO	526
POMPA BENZINA ELETTRICA	450	<b>ALBERO A CAMME</b>	483	POMPA OLIO	523
POMPA BENZINA MECCANICA	450	<b>ALBERO MOTORE</b>	490	POMPA ACQUA	523
<b>POMPA BENZINA IN LINEA</b>	442	BIELLA	491	RONDELLA / SPESSORE	526
MOLLA TUBO COMBUSTIBILE	443	CUSCINETTI ALBERO MOTORE	490	SUPERIORE, ALBERO DI TRASMISSIONE	524
POMPA BENZINA	442	CUSCINETTI BIELLA	491	<b>PARTI PIEDI 4 TEMPI</b>	496
TUBO BENZINA	442	PARTE ALBERO MOTORE	490	DF4 • DF5 • DF6	496
TUBO CARBURANTE	442	RONDELLE BIELLA	491	DF8 • DF9,9 • DF15 • DF20	498
<b>SISTEMA ELETTRICO</b>	455	<b>GUARNIZIONI MOTORE 4 TEMPI</b>	483	DF20 • DF25	504
<b>BOBINE</b>	455	GUARNIZIONE COPERCHIO PUNTERIE	486	DF30	506
REGOLATORE - BOBINA	455	GUARNIZIONE BASE MOTORE	484	DF40 • DF50	508
<b>CANDELE</b>	455	GUARNIZIONE BASE OLIO	485	DF60	510
<b>CDI E CENTRALINA</b>	460	GUARNIZIONE BASE PARAOLIO	485	DF70	512
<b>CHIAVETTA DI SICUREZZA</b>	460	GUARNIZIONE CARTER, CATENA GUIDA BASE	485	DF80 • DF90 • DF100	513
KIT	461	GUARNIZIONE COPERCHIO FILTRO	485	DF115 • DF140	514
<b>CHIAVI DI ACCENSIONE</b>	458	GUARNIZIONE COPERCHIO SILEMBLOCK	486	DF150 • DF175 • DF200 • DF225 • DF250	517
GUIDA REGOLATORE E RETTIFICATORE	459	GUARNIZIONE COPERCHIO TERMOSTATO	486	DF300	518
<b>MOTORINI AVVIAMENTO</b>	457	GUARNIZIONE CORPO FARFALLATO	485	<b>SELETTORE</b>	522
SOLENOIDE PER MOTORINI AVVIAMENTO	458	GUARNIZIONE OLIO	485	ASTA PRESSIONE	523
<b>REGOLATORI E RADDRIZZATORI</b>	458	GUARNIZIONE PARAOLIO SUPERIORE	486	HEBEL	523
GUIDA REGOLATORI RADDRIZZATORI	459	GUARNIZIONE TESTATA	483	MOLLA SELETTORE	522
<b>RELE</b>	460	GUARNIZIONE VALVOLA PRESSIONE	486	PIN SELETTORE	522
<b>SENSORE</b>	454	GUIDA GUARNIZIONE TESTATA	484	SELETTORE	522
SENSORE CMP	454	KIT GUARNIZIONE TESTATA	484	SPINOTTO	522
SENSORE IAC	454	<b>GUARNIZIONI MOTORE 2 TEMPI</b>	487	<b>SISTEMA DI PROPULSIONE</b>	527
SENSORE MAP	454	GUARNIZIONE BASE OLIO	488	<b>ELICHE ALLUMINIO E INOX DA 2 E 4 PALE</b>	527
<b>TRIM, TILT &amp; POWER TRIM</b>	461	GUARNIZIONE COPERCHIO TERMOSTATO	488	COPPIGLIA	532
ESTRATTORE PER TAPPI DI TRIM	463	GUARNIZIONE COPERCHIO TESTATA	488	DADO DI ELICA	532
INSTALLAZIONE ELETTRICA	461	GUARNIZIONE DE TESTATA	487	DISTANZIALE ELICA	532
MOTORINO POWER TRIM COMPLETO	462	GUIDA GUARNIZIONE TESTATA	487	ELICHE PER MOZZO INTERCAMBIABILE	530
MOTORINO TRIM COMPLETO	461	<b>GUIDA CINGHIE DISTRIBUZIONE</b>	492	GUIDA ELICHE CON MOZZO	528
SENSORI TRIM	463	<b>PARAOLIO</b>	488	GUIDA RICAMBIO PIEDE	531
TAPPO TRIM	463	GUARNIZIONE TAPPO DRENAGIO	490	KIT CHIUSURA ELICA	531
<b>SISTEMA DI GUIDA</b>	464	<b>PARTI MOTORE 4 TEMPI</b>	481	MOZZO INTERCAMBIABILE	529
<b>CAVI</b>	466	DF40 • DF50	481	PIN ELICA	532
ESTENSIONE SISTEMA ANALOGICO	466	DF70 • DF80 • DF90 • DF100	482	<b>REF --&gt; RO</b>	533
<b>COMANDI DI CONTROLLO</b>	464	<b>PARTI MOTORE 2 TEMPI</b>	480	<b>RO --&gt; REF</b>	538
COMANDO LATERALE	464	DT40 • DTW	480		
COMANDO PER CONSOLLA	465	<b>PISTONE</b>	492		
<b>COMPONENTI</b>	466	KIT PISTONE	492		
CAVO ACCELERATORE	467				
CAVO COMANDO	467				
CAVO CONNETTORE	466				

GUIDE MAINTENANCE KITS	439	CÂBLES DE COMMANDE	467	ROULEMENTS DE BIELLE	491
<b>SYSTÈME D'ALIMENTATION ET DE FILTRATION</b>	442	CALE POIGNEE DE CONTRÔLE	466	ROULEMENTS VILEBREQUIN	490
CARBURATEUR	453	CLIP	466	<b>SYSTÈME D'ÉCHAPPEMENT ET SYSTÈME D'ADMISSION</b>	493
CARBURATEUR COMPLET	453	DIRECTION HYDRAULIQUE	467	<b>SYSTÈME D'ADMISSION 4 TEMPS</b>	494
FLOTTEUR DE CARBURATEUR	453	EMBOUT DE CABLE	466	JOINTS DE COLLECTEUR	494
KIT CARBURATEUR	453	<b>FAISCEAU ELECTRIQUE</b>	466	JOINTS DE COUVERCLE D'ÉCHAPPEMENT	494
<b>COMPOSANTS ET CONNECTEURS DU RÉSERVOIR</b>	443	RALLONGE FAISCEAU SYSTÈME ANALOGIQUE	466	<b>SYSTÈME D'ÉCHAPPEMENT 4 TEMPS</b>	493
PASSE-CLOISON	444	<b>INTERRUPTEUR DE CONTRÔLE</b>	465	JOINTS COLLECTEUR	493
RACCORDS DE RESERVOIR	443	BOITIER DE DEMARRAGE 2 MOTEURS	465	JOINTS DE CARTER	493
<b>FILTRE À ESSENCE ET CARTOUCHE DE RECHANGE</b>	445	TABLEAU DE COMMANDE SIMPLE	465	JOINTS DE PIPE D'ÉCHAPPEMENT	493
CLÉ À FILTRE	447	<b>SYSTÈME DE REFROIDISSEMENT</b>	468	<b>SYSTÈME D'ÉCHAPPEMENT 2 TEMPS</b>	495
FILTRE DÉCANTEUR ESSENCE	446	<b>ANODES</b>	476	JOINTS D'ÉCHAPPEMENT	495
FILTRE DÉCANTEUR ESSENCE AVEC BOL TRANSPARENT	445	ANODE CANADA METAL	476	JOINTS DE PLAQUE D'ÉCHAPPEMENT	495
FILTRE À ESSENCE EN LIGNE	447	ANODE TECNOSSEAL	478	JOINTS DE TUBE D'ÉCHAPPEMENT	495
FILTRE À ESSENCE HAUTE PRESION	448	KIT ANODES	476	<b>EMBASES ET PIÈCES</b>	496
FILTRE SÉPARATEUR EAU-ESSENCE	455	JOINT, COUVERCLE D'ANODE	479	<b>CRABOT</b>	522
RACCORDS	447	JOINT TORIQUE	479	EMBOUT DE SELECTEUR	523
TÊTE DE FILTRE À ESSENCE	445	VIS INOX	479	PIN	522
<b>FILTRE À HUILE</b>	449	<b>GUIDE TURBINES</b>	469	PIVOT	522
GUIDE FILTRE A HUILE	449	CLAVETTE	470	RESSORT DE SELECTEUR	522
JOINT DE VIDANGE	449	GUIDE DE TURBINES	469	TIGE DE POUSSEE	523
<b>HUILES</b>	450	PLAQUE DE POMPE À EAU	471	<b>PIÈCES D'EMBASES DE 4 TEMPS</b>	496
<b>INJECTEURS</b>	451	<b>POMPE D'EAU</b>	471	DF4 • DF5 • DF6	496
GUIDE INJECTEURS ET SONDES	452	CORPS DE POMPE À EAU	471	DF8 • DF9.9 • DF15 • DF20	498
<b>POIRE À CARBURANT</b>	442	GUIDE KITS POMPES A EAU	476	DF20 • DF25	504
COLLIER	443	INSERT INOX	473	DF30	506
POIRE À CARBURANT	442	JOINTS, BASE DE POMPE À EAU	472	DF40 • DF50	508
RACCORD COUPLEUR	443	JOINTS POMPE	473	DF60	510
RESSORT, TUYAU DE CARBURANT	443	JOINTS, TORIQUE DE POMPE À EAU	472	DF70	512
TUYAU CARBURANT	442	KIT REPARATION DE POMPE À EAU	474	DF80 • DF90 • DF100	513
<b>POMPE À ESSENCE</b>	450	PLAQUE DE POMPE À EAU	472	DF115 • DF140	514
JOINTS VST	451	<b>THERMOSTAT</b>	468	DF150 • DF175 • DF200 • DF225 • DF250	517
MEMBRANES ET JOINTS	451	BOUCHON DE REGROIDISSEMENT	469	DF300	518
POMPE À ESSENCE ELECTRIQUE	450	<b>PIÈCES MOTEUR</b>	480	<b>PIÈCES D'EMBASES</b>	519
POMPE À ESSENCE MECANIQUE	450	<b>ARBRE À CAMES</b>	483	DIABOLO	521
<b>SYSTÈME ÉLECTRIQUE</b>	455	<b>GUIDE DES COURROIES DE DISTRIBUTION</b>	492	ÉCROU DU LEVIER DE CHANGEMENT DE VITESSE	520
<b>BOBINES</b>	455	<b>JOINTS DE MOTEUR 4 TEMPS</b>	483	GUIDE DES KITS JOINTS	520
REGULATEUR-BOBINE	455	GUIDE JOINTS DE CULASSE	484	JOINT TORIQUE DU LEVIER	520
<b>BOUGIES</b>	455	JOINTS D'HUILE	485	JOINT TORIQUE DU DIABOLO	521
<b>CAPTEURS</b>	454	JOINTS D'HUILE SUPERIEUR	486	KITS JOINTS D'EMBASES	519
CAPTEUR CMP	454	JOINTS DE CACHE CULBUTEUR	486	SOUFFLET DU LEVIER DE CHANGEMENT DE VITESSE	520
CAPTEUR IAC	454	JOINTS DE COUVERCLE	485	TUBE DE VIDANGE DE LA POMPE À EAU	521
CAPTEUR MAP	454	JOINTS DE COUVERCLE DE FILTRE	485	VIS ET JOINTS DE VIDANGE	521
<b>CDI ET BOITIER ELECTRONIQUE</b>	460	JOINTS DE GUIDE CHAINE	485	<b>ROULEMENT</b>	523
<b>CONTACTEUR A CLÉ</b>	458	JOINTS DE THROTTLE BODY	485	CLIPS	524
<b>COUPE CIRCUIT DE SECURITE</b>	460	JOINTS LOGEMENT THERMOSTAT	486	DE DIABOLO	524
KITS	461	JOINTS SOUPE DE PRESSION	486	DE POMPE À EAU	523
<b>DEMARREUR</b>	457	JOINTS BASE D'HUILE	485	DE POMPE À HUILE	523
SOLENOIDE POUR DEMARREUR	458	JOINTS DE CULASSE	483	INFERIEUR D'ARBRE DE TRANSMISSION	524
<b>REGULATEURS ET RECTIFIEURS</b>	458	JOINTS DE TÊTE MOTRICE	484	PIGNON D'ATTAQUE	525
GUIDE REGULATEURS ET RECTIFIEURS	459	KIT JOINTS DE MOTEUR	484	PIGNON DE MARCHÉ AVANT	525
<b>RELAIS</b>	460	<b>JOINTS DE MOTEUR 2 TEMPS</b>	487	PIGNON DE MARCHÉ ARRIÈRE	526
<b>TRIM, TILT &amp; POWER TRIM</b>	461	GUIDE JOINTS DE CULASSE	487	RONDELLE / CALE	526
BOUCHON VERIN DE TRIM	463	JOINT DE COUVRE CULASSE	488	SUPERIEUR D'ARBRE DE TRANSMISSION	524
EMETTEUR DE TRIM	463	JOINTS DE CULASSE	487	<b>SYSTEME DE PROPULSION</b>	527
INSTALLATION ELECTRIQUE	461	JOINTS DE TÊTE MOTRICE	488	<b>HÉLICE ALUMINIUM ET INOX 3 ET 4 PALES</b>	527
KIT EXTRACTEUR	463	JOINTS LOGEMENT THERMOSTAT	488	CLAVETTE D'HÉLICE	532
MOTEUR DE TRIM	461	<b>JOINT SPI</b>	488	ÉCROU D'HÉLICE	532
POWER TRIM COMPLET	462	JOINT DE VIDANGE	490	ENTRETOIS D'HÉLICE	532
<b>SYSTÈME DE COMMANDE</b>	464	<b>PIECES MOTEURS DE 4 TEMPS</b>	481	GUIDE DES HÉLICES ET MOYEUX	528
<b>BOITIER DE COMMANDE</b>	464	DF40 • DF50	481	GUIDE DES PIÈCES D'EMBASE	531
BOITIER LATERAL	464	DF70 • DF80 • DF90 • DF100	482	GOUPILLE D'ECROU D'HELICE	532
BOITIER POUR CONSOLE	465	<b>PIECES MOTEUR 2 TEMPS</b>	480	HELICES AVEC MOYEU INTERCHANGEABLE	530
<b>COMPOSANT</b>	466	DT40 • DTW	480	KIT ÉCROU D'HÉLICE	531
BAGUE	466	<b>PISTONS</b>	492	MOYEU INTERCHANGEABLE	529
CÂBLE D'ACCELERATEUR	467	KIT PISTON	492	REF --> RO	533
		VILEBREQUIN	490	RO --> REF	538
		BIELLE	491		
		PARTIES DE VILEBREQUIN	490		
		RONDELLE DE BIELLE	491		



GUÍA KITS  
MANTENIMIENTO

MAINTENANCE  
GUIDE & KITS

GUIDA  
MANUTENZIONE  
E KIT

GUIDE  
MAINTENANCE  
KITS

	KIT	REF						
DF2 DF2.5 (2006-11)		REC17400-97820	REC17461-97JMO	TURBINA	IMPELLER	GIRANTE	TURBINE	1
			NGKCR6HSA	BUJÍA	SPARK PLUG	CANDELE	BOUGIE	1
			PAGB/T91-1.6X12	PIN BLOQUEADOR	COTTER PIN	COPPIGLIA	GOUPILLE	1
			REC09168-10022	ARANDELA TAPÓN	CAP, O-RING	RONDELLA TAPPO	JOINT DE VIDANGE	1
			REC59178-97J00	JUNTA DRENAJE COLA	DRAIN PLUG GASKET	GUARNIZIONE DRENAGGIO	JOINT DE VIDANGE D'EMBASE	2
			CM55321-87J00A	ÁNODO	ANODE	ANODO	ANODE	1
			PAJASOF404-19-033	TÓRICA	O-RING	O-RING	JOINT TORIQUE	1
			PAGB/T879.1-2.5X14	PIN	PIN	PIN	PIN	1
			REC17471-97J00	PLACA	PLATE	PIASTRA	PLAQUE	1
			REC17472-97J00	JUNTA BASE DE BOMBA	GASKET, CASE	GUARNIZIONE, BASE POMPA	JOINT, BASE POMPE	1
DF2 DF2.5 (2012+)		REC17400-97810	REC17461-97JMO	TURBINA	IMPELLER	GIRANTE	TURBINE	1
			NGKCR6HSA	BUJÍA	SPARK PLUG	CANDELE	BOUGIE	1
			REC91490-40030	PIN BLOQUEADOR	COTTER PIN	COPPIGLIA	GOUPILLE	1
			REC09168-10022	ARANDELA TAPÓN	CAP, O-RING	RONDELLA TAPPO	JOINT DE VIDANGE	1
			REC59178-97J00	JUNTA DRENAJE COLA	DRAIN PLUG GASKET	GUARNIZIONE DRENAGGIO	JOINT DE VIDANGE D'EMBASE	2
			CM55321-87J00A	ÁNODO	ANODE	ANODO	ANODE	1
			PAJASOF404-19-033	TÓRICA	O-RING	O-RING	JOINT TORIQUE	1
			PAGB/T879.1-2.5X14	PIN	PIN	PIN	PIN	1
			REC17471-97JLO	PLACA	PLATE	PIASTRA	PLAQUE	1
			REC17472-97JLO	JUNTA BASE DE BOMBA	GASKET, CASE	GUARNIZIONE, BASE POMPA	JOINT, BASE POMPE	1
DF4 DF5 DF6 (2002-10)		REC17400-91860	REC17400-98661	KIT BOMBA DE AGUA	WATER PUMP KIT	KIT POMPA ACQUA	KIT POMPE À EAU	1
			REC91490-40030	PIN BLOQUEADOR	COTTER PIN	COPPIGLIA	GOUPILLE	1
			NGKBPR6ES	BUJÍA	SPARK PLUG	CANDELE	BOUGIE	1
			REC09168-10022	ARANDELA TAPÓN	CAP, O-RING	RONDELLA TAPPO	JOINT DE VIDANGE	3
			CM55321-87J00A	ÁNODO	ANODE	ANODO	ANODE	2
	REC15410-98500	FILTRO COMBUSTIBLE	FUEL FILTER	FILTRO COMBUSTIBILE	FILTRE À ESSENCE	1		
DF4 DF5 DF6 (2011+)		REC17400-91830	REC17400-98661	KIT BOMBA DE AGUA	WATER PUMP KIT	KIT POMPA ACQUA	KIT POMPE À EAU	1
			REC91490-40030	PIN BLOQUEADOR	COTTER PIN	COPPIGLIA	GOUPILLE	1
			NGKCPR6EA-9	BUJÍA	SPARK PLUG	CANDELE	BOUGIE	1
			REC09168-10022	ARANDELA TAPÓN	CAP, O-RING	RONDELLA TAPPO	JOINT DE VIDANGE	3
			CM55321-87J00A	ÁNODO	ANODE	ANODO	ANODE	2
	REC15410-98500	FILTRO COMBUSTIBLE	FUEL FILTER	FILTRO COMBUSTIBILE	FILTRE À ESSENCE	1		
DF8A DF9.9A (2010+)		REC17400-99840	REC15410-98500	FILTRO COMBUSTIBLE	FUEL FILTER	FILTRO COMBUSTIBILE	FILTRE À ESSENCE	1
			REC16510-05240	FILTRO DE ACEITE	OIL FILTER	FILTRO OLIO	FILTRE A HUILE	1
			REC09204-02004	PIN BLOQUEADOR	COTTER PIN	COPPIGLIA	GOUPILLE	1
			REC09280-54001	TÓRICA	O-RING	O-RING	JOINT TORIQUE	1
			REC09168-12017	JUNTA	GASKET	GUARNIZIONE	JOINT	1
			REC59178-97J00	JUNTA DRENAJE COLA	DRAIN PLUG GASKET	GUARNIZIONE DRENAGGIO	JOINT DE VIDANGE D'EMBASE	2
			CM55321-87J00A	ÁNODO	ANODE	ANODO	ANODE	2
			REC09280-22019	TÓRICA	O-RING	O-RING	JOINT TORIQUE	1
			NGKCR6E	BUJÍA	SPARK PLUG	CANDELE	BOUGIE	1
	REC17400-99J01	KIT BOMBA DE AGUA	WATER PUMP KIT	KIT POMPA ACQUA	KIT POMPE À EAU	2		
DF9.9B DF15A (2011-13)		REC17400-94810	REC17400-94J00	KIT BOMBA DE AGUA	WATER PUMP KIT	KIT POMPA ACQUA	KIT POMPE À EAU	1
			REC09204-02004	PIN BLOQUEADOR	COTTER PIN	COPPIGLIA	GOUPILLE	1
			NGKCPR6EA-9	BUJÍA	SPARK PLUG	CANDELE	BOUGIE	2
			REC16510-05240	FILTRO DE ACEITE	OIL FILTER	FILTRO OLIO	FILTRE A HUILE	1
			CM5033167	ÁNODO	ANODE	ANODO	ANODE	1
			REC09168-12017	JUNTA	GASKET	GUARNIZIONE	JOINT	1
DF9.9B DF15A DF20A (2013+)		REC17400-89810	REC17400-99J01	KIT BOMBA DE AGUA	WATER PUMP KIT	KIT POMPA ACQUA	KIT POMPE À EAU	1
			REC09204-02004	PIN BLOQUEADOR	COTTER PIN	COPPIGLIA	GOUPILLE	1
			NGKCPR6EA-9	BUJÍA	SPARK PLUG	CANDELE	BOUGIE	2
			REC16510-05240	FILTRO DE ACEITE	OIL FILTER	FILTRO OLIO	FILTRE A HUILE	1
			REC09280-54001	TÓRICA	O-RING	O-RING	JOINT TORIQUE	1
			CM55321-87J00A	ÁNODO	ANODE	ANODO	ANODE	2
			REC09280-22019	TÓRICA	O-RING	O-RING	JOINT TORIQUE	1
			REC09168-12017	JUNTA	GASKET	GUARNIZIONE	JOINT	1
			REC59178-97J00	JUNTA DRENAJE COLA	DRAIN PLUG GASKET	GUARNIZIONE DRENAGGIO	JOINT DE VIDANGE D'EMBASE	2
	REC15410-87L00	FILTRO COMBUSTIBLE	FUEL FILTER	FILTRO COMBUSTIBILE	FILTRE À ESSENCE	1		
DF20 DF25 V2 (2006+)		REC17400-95870	REC17400-95J02	KIT BOMBA DE AGUA	WATER PUMP KIT	KIT POMPA ACQUA	KIT POMPE À EAU	1
			REC16510-87J00	FILTRO DE ACEITE	OIL FILTER	FILTRO OLIO	FILTRE A HUILE	1
			NGKBKR6E	BUJÍA	SPARK PLUG	CANDELE	BOUGIE	2
			REC91490-40030	PIN BLOQUEADOR	COTTER PIN	COPPIGLIA	GOUPILLE	1
			REC09168-10022	ARANDELA TAPÓN	CAP, O-RING	RONDELLA TAPPO	JOINT DE VIDANGE	2
			REC09168-12012	JUNTA	GASKET	GUARNIZIONE	JOINT	1
			CM55321-87J00A	ÁNODO	ANODE	ANODO	ANODE	5
			REC09280-22019	TÓRICA	O-RING	O-RING	JOINT TORIQUE	1
			REC17413-95J00	CASQUILLO INOX	SLEEVE WATER PUMP	CAPPUCCIO	INSERT DE POMPE À EAU	1
	REC15410-87J30	FILTRO COMBUSTIBLE	FUEL FILTER	FILTRO COMBUSTIBILE	FILTRE À ESSENCE	1		

	KIT	REF						
DF25 DF30 (2001-10)		REC17400-89820	REC17400-96403	KIT BOMBA DE AGUA	WATER PUMP KIT	KIT POMPA ACQUA	KIT POMPE À EAU	1
		REC16510-87J00	REC16510-87J00	FILTRO DE ACEITE	OIL FILTER	FILTRO OLIO	FILTRE A HUILE	1
		NGKDCPR6E	NGKDCPR6E	BUJÍA	SPARK PLUG	CANDELE	BOUGIE	3
		REC91490-40030	REC91490-40030	PIN BLOQUEADOR	COTTER PIN	COPPIGLIA	GOUPILLE	1
		REC09168-10022	REC09168-10022	ARANDELA TAPÓN	CAP, O-RING	RONDELLA TAPPO	JOINT DE VIDANGE	2
		REC09168-12012	REC09168-12012	JUNTA	GASKET	GUARNIZIONE	JOINT	1
		CM55321-87J00A	CM55321-87J00A	ANODO	ANODE	ANODO	ANODE	1
		REC15410-87J10	REC15410-87J10	FILTRO COMBUSTIBLE	FUEL FILTER	FILTRO COMBUSTIBILE	FILTRE À ESSENCE	1
		REC17400-94821	REC17400-94821	KIT BOMBA DE AGUA	WATER PUMP KIT	KIT POMPA ACQUA	KIT POMPE À EAU	1
		DF25A DF30A (2015+)		REC17400-94821	REC17400-94821	KIT BOMBA DE AGUA	WATER PUMP KIT	KIT POMPA ACQUA
REC91490-40030	REC91490-40030			PIN BLOQUEADOR	COTTER PIN	COPPIGLIA	GOUPILLE	1
NGKDCPR6EA-9	NGKDCPR6EA-9			BUJÍA	SPARK PLUG	CANDELE	BOUGIE	3
REC16510-87J00	REC16510-87J00			FILTRO DE ACEITE	OIL FILTER	FILTRO OLIO	FILTRE A HUILE	1
CM55321-87J00A	CM55321-87J00A			ANODO	ANODE	ANODO	ANODE	5
REC09280-22019	REC09280-22019			TÓRICA	O-RING	O-RING	JOINT TORIQUE	1
REC09168-12017	REC09168-12017			JUNTA	GASKET	GUARNIZIONE	JOINT	1
REC59178-97J00	REC59178-97J00			JUNTA DRENAJE COLA	DRAIN PLUG GASKET	GUARNIZIONE DRENAGGIO	JOINT DE VIDANGE D'EMBASE	2
REC15410-87L00	REC15410-87L00			FILTRO COMBUSTIBLE	FUEL FILTER	FILTRO COMBUSTIBILE	FILTRE À ESSENCE	1
DF40 DF50 (2006-10)				REC17400-87820	REC17400-96403	KIT BOMBA DE AGUA	WATER PUMP KIT	KIT POMPA ACQUA
		REC16510-87J00	REC16510-87J00	FILTRO DE ACEITE	OIL FILTER	FILTRO OLIO	FILTRE A HUILE	1
		NGKDCPR6E	NGKDCPR6E	BUJÍA	SPARK PLUG	CANDELE	BOUGIE	3
		REC91490-40030	REC91490-40030	PIN BLOQUEADOR	COTTER PIN	COPPIGLIA	GOUPILLE	1
		REC09168-10022	REC09168-10022	ARANDELA TAPÓN	CAP, O-RING	RONDELLA TAPPO	JOINT DE VIDANGE	2
		REC09168-12012	REC09168-12012	JUNTA	GASKET	GUARNIZIONE	JOINT	1
		CM55321-87J00A	CM55321-87J00A	ANODO	ANODE	ANODO	ANODE	2
		REC09280-22019	REC09280-22019	TÓRICA	O-RING	O-RING	JOINT TORIQUE	2
		REC15410-87J30	REC15410-87J30	FILTRO COMBUSTIBLE	FUEL FILTER	FILTRO COMBUSTIBILE	FILTRE À ESSENCE	1
		DF40A DF50A DF60A (2010+)		REC17400-88810	REC17400-88L00	KIT BOMBA DE AGUA	WATER PUMP KIT	KIT POMPA ACQUA
REC91490-40030	REC91490-40030			PIN BLOQUEADOR	COTTER PIN	COPPIGLIA	GOUPILLE	1
REC16510-87J00	REC16510-87J00			FILTRO DE ACEITE	OIL FILTER	FILTRO OLIO	FILTRE A HUILE	1
NGKDCPR6E	NGKDCPR6E			BUJÍA	SPARK PLUG	CANDELE	BOUGIE	3
REC09168-12012	REC09168-12012			JUNTA	GASKET	GUARNIZIONE	JOINT	1
REC09168-10022	REC09168-10022			ARANDELA TAPÓN	CAP, O-RING	RONDELLA TAPPO	JOINT DE VIDANGE	2
CM55321-87J00A	CM55321-87J00A			ANODO	ANODE	ANODO	ANODE	3
REC09280-22019	REC09280-22019			TÓRICA	O-RING	O-RING	JOINT TORIQUE	2
REC15410-88L00	REC15410-88L00			FILTRO COMBUSTIBLE	FUEL FILTER	FILTRO COMBUSTIBILE	FILTRE À ESSENCE	1
DF60 DF70 (1997-07)				REC17400-99870	REC17400-87E04	KIT BOMBA DE AGUA	WATER PUMP KIT	KIT POMPA ACQUA
		REC16510-87J00	REC16510-87J00	FILTRO DE ACEITE	OIL FILTER	FILTRO OLIO	FILTRE A HUILE	1
		NGKBPR6ES	NGKBPR6ES	BUJÍA	SPARK PLUG	CANDELE	BOUGIE	4
		REC91490-40030	REC91490-40030	PIN BLOQUEADOR	COTTER PIN	COPPIGLIA	GOUPILLE	1
		REC09168-10022	REC09168-10022	ARANDELA TAPÓN	CAP, O-RING	RONDELLA TAPPO	JOINT DE VIDANGE	2
		REC09168-12012	REC09168-12012	JUNTA	GASKET	GUARNIZIONE	JOINT	1
		CM55321-87J00A	CM55321-87J00A	ANODO	ANODE	ANODO	ANODE	1
		REC15410-87J30	REC15410-87J30	FILTRO COMBUSTIBLE	FUEL FILTER	FILTRO COMBUSTIBILE	FILTRE À ESSENCE	1
		REC17400-87810	REC17400-87L01	KIT BOMBA DE AGUA	WATER PUMP KIT	KIT POMPA ACQUA	KIT POMPE À EAU	1
		DF70A DF80A DF90A (2009+)		REC17400-87810	REC16510-90J00	FILTRO DE ACEITE	OIL FILTER	FILTRO OLIO
NGKDCPR6E	NGKDCPR6E			BUJÍA	SPARK PLUG	CANDELE	BOUGIE	4
REC09168-12012	REC09168-12012			JUNTA	GASKET	GUARNIZIONE	JOINT	1
REC09168-10034	REC09168-10034			JUNTA	GASKET	GUARNIZIONE	JOINT	2
CM55321-87J00A	CM55321-87J00A			ANODO	ANODE	ANODO	ANODE	3
REC91490-40030	REC91490-40030			PIN BLOQUEADOR	COTTER PIN	COPPIGLIA	GOUPILLE	1
REC09280-22019	REC09280-22019			TÓRICA	O-RING	O-RING	JOINT TORIQUE	3
REC15410-87L00	REC15410-87L00			FILTRO COMBUSTIBLE	FUEL FILTER	FILTRO COMBUSTIBILE	FILTRE À ESSENCE	1
REC17400-92840	REC17400-92J21			KIT BOMBA DE AGUA	WATER PUMP KIT	KIT POMPA ACQUA	KIT POMPE À EAU	1
DF100 DF115 (2010-12)				REC17400-92840	REC16510-90J00	FILTRO DE ACEITE	OIL FILTER	FILTRO OLIO
		NGKBKR6E	NGKBKR6E	BUJÍA	SPARK PLUG	CANDELE	BOUGIE	4
		REC91490-40030	REC91490-40030	PIN BLOQUEADOR	COTTER PIN	COPPIGLIA	GOUPILLE	1
		REC09168-10022	REC09168-10022	ARANDELA TAPÓN	CAP, O-RING	RONDELLA TAPPO	JOINT DE VIDANGE	2
		REC09168-12012	REC09168-12012	JUNTA	GASKET	GUARNIZIONE	JOINT	1
		CM55321-87J00A	CM55321-87J00A	ANODO	ANODE	ANODO	ANODE	4
		REC09280-22019	REC09280-22019	TÓRICA	O-RING	O-RING	JOINT TORIQUE	2
		REC09420-05009	REC09420-05009	CHAVETA	KEY	CHIAVETTA	CLAVETTE	1
		REC15410-87J30	REC15410-87J30	FILTRO COMBUSTIBLE	FUEL FILTER	FILTRO COMBUSTIBILE	FILTRE À ESSENCE	1

	KIT	REF						
DF100A DF115A DF140A (2013+)		REC17400-92821	REC17400-92J21	KIT BOMBA DE AGUA	WATER PUMP KIT	KIT POMPA ACQUA	KIT POMPE À EAU	1
			REC16510-90J00	FILTRO DE ACEITE	OIL FILTER	FILTRO OLIO	FILTRE A HUILE	1
			NGKBKR6E	BUJÍA	SPARK PLUG	CANDELE	BOUGIE	4
			REC91490-40030	PIN BLOQUEADOR	COTTER PIN	COPPIGLIA	GOUPILLE	1
			REC09168-10022	ARANDELA TAPÓN	CAP, O-RING	RONDELLA TAPPO	JOINT DE VIDANGE	2
			REC09168-12012	JUNTA	GASKET	GUARNIZIONE	JOINT	1
			CM55321-87J00A	ANODO	ANODE	ANODO	ANODE	4
			REC09280-22019	TÓRICA	O-RING	O-RING	JOINT TORIQUE	2
			REC09420-05009	CHAVETA	KEY	CHIAVETTA	CLAVETTE	1
	REC15412-92J00	FILTRO COMBUSTIBLE	FUEL FILTER	FILTRO COMBUSTIBILE	FILTRE À ESSENCE	1		
DF150 DF175 (2006+)		REC17400-92850	REC17400-92J21	KIT BOMBA DE AGUA	WATER PUMP KIT	KIT POMPA ACQUA	KIT POMPE À EAU	1
			REC16510-90J00	FILTRO DE ACEITE	OIL FILTER	FILTRO OLIO	FILTRE A HUILE	1
			NGKBKR6E	BUJÍA	SPARK PLUG	CANDELE	BOUGIE	4
			REC91490-40030	PIN BLOQUEADOR	COTTER PIN	COPPIGLIA	GOUPILLE	1
			REC09168-10022	ARANDELA TAPÓN	CAP, O-RING	RONDELLA TAPPO	JOINT DE VIDANGE	2
			REC09168-12012	JUNTA	GASKET	GUARNIZIONE	JOINT	1
			CM55321-87J00A	ANODO	ANODE	ANODO	ANODE	4
			REC09280-22019	TÓRICA	O-RING	O-RING	JOINT TORIQUE	2
			REC09420-05009	CHAVETA	KEY	CHIAVETTA	CLAVETTE	1
	REC15410-87J30	FILTRO COMBUSTIBLE	FUEL FILTER	FILTRO COMBUSTIBILE	FILTRE À ESSENCE	1		
DF150 DF175 (2006+)		REC17400-96821	REC17400-96J03	KIT BOMBA DE AGUA	WATER PUMP KIT	KIT POMPA ACQUA	KIT POMPE À EAU	1
			REC16510-96J00	FILTRO DE ACEITE	OIL FILTER	FILTRO OLIO	FILTRE A HUILE	1
			NGKBKR6E	BUJÍA	SPARK PLUG	CANDELE	BOUGIE	4
			REC91490-40030	PIN BLOQUEADOR	COTTER PIN	COPPIGLIA	GOUPILLE	1
			REC09168-10034	JUNTA	GASKET	GUARNIZIONE	JOINT	2
			REC09168-12012	JUNTA	GASKET	GUARNIZIONE	JOINT	1
			CM55321-87J00A	ANODO	ANODE	ANODO	ANODE	6
			REC09280-22019	TÓRICA	O-RING	O-RING	JOINT TORIQUE	5
			REC17413-96J01	CASQUILLO INOX	SLEEVE WATER PUMP	CAPPUCCIO	INSERT DE POMPE À EAU	1
	REC15410-96J00	FILTRO COMBUSTIBLE	FUEL FILTER	FILTRO COMBUSTIBILE	FILTRE À ESSENCE	1		
DF200 DF225 DF250 (2011+)		REC17400-93851	REC17400-93J01	KIT BOMBA DE AGUA	WATER PUMP KIT	KIT POMPA ACQUA	KIT POMPE À EAU	1
			REC16510-96J00	FILTRO DE ACEITE	OIL FILTER	FILTRO OLIO	FILTRE A HUILE	1
			NGKBKR6E	BUJÍA	SPARK PLUG	CANDELE	BOUGIE	6
			REC91490-40030	PIN BLOQUEADOR	COTTER PIN	COPPIGLIA	GOUPILLE	1
			REC09168-10034	JUNTA	GASKET	GUARNIZIONE	JOINT	2
			REC09168-12012	JUNTA	GASKET	GUARNIZIONE	JOINT	1
			CM55321-87J00A	ANODO	ANODE	ANODO	ANODE	7
			REC09280-22019	TÓRICA	O-RING	O-RING	JOINT TORIQUE	7
			CM55321-94900A	ANODO	ANODE	ANODO	ANODE	1
	REC15412-93J10	FILTRO COMBUSTIBLE	FUEL FILTER	FILTRO COMBUSTIBILE	FILTRE À ESSENCE	1		
DF250A DF250S DF300 (A) (2011+)		REC17400-98861	REC17400-98J01	KIT BOMBA DE AGUA	WATER PUMP KIT	KIT POMPA ACQUA	KIT POMPE À EAU	1
			REC16510-96J00	FILTRO DE ACEITE	OIL FILTER	FILTRO OLIO	FILTRE A HUILE	1
			NGKBKR6E	BUJÍA	SPARK PLUG	CANDELE	BOUGIE	6
			REC91490-40030	PIN BLOQUEADOR	COTTER PIN	COPPIGLIA	GOUPILLE	1
			REC09168-10034	JUNTA	GASKET	GUARNIZIONE	JOINT	2
			REC09168-12012	JUNTA	GASKET	GUARNIZIONE	JOINT	1
			CM55321-87J00A	ANODO	ANODE	ANODO	ANODE	8
			REC09280-22019	TÓRICA	O-RING	O-RING	JOINT TORIQUE	7
			CM55321-94900A	ANODO	ANODE	ANODO	ANODE	1
	REC15412-93J10	FILTRO COMBUSTIBLE	FUEL FILTER	FILTRO COMBUSTIBILE	FILTRE À ESSENCE	1		



# SISTEMA DE ALIMENTACIÓN Y FILTRACIÓN FUEL & FILTRATION SYSTEM

# SISTEMA DI ALIMENTAZIONE E FILTRAZIONE SYSTÈME D'ALIMENTATION ET DE FILTRATION

## BOMBA DE COMBUSTIBLE

## FUEL PUMP

## POMPA BENZINA

## POIRE À CARBURANT

### BOMBA DE COMBUSTIBLE

### FUEL PUMP

### POMPA BENZINA

### POIRE À CARBURANT

Fabricada con elastómeros termoplásticos inyectados, resistentes al alcohol y rayos UV.s

Premium quality bulb resistance to alcohol as well as UV and ozone.

Fabbricata con elastomero termoplastico, resistente ai solventi e raggi UV.

Fabriqué avec des élastomères thermo-plastiques injectés, résistant à l'alcool et aux rayons UV.

REF	RO OEM			
GS31187	65770-95541	1/4" = 6 mm	1	
GS31090	65770-95504	5/16" = 8 mm	1	
GS31095	65770-93J12	3/8" = 9.5 mm	1	
GS31090	65770-90J12	5/16" = 8 mm	1	

### LÍNEA DE COMBUSTIBLE

### FUEL LINE ASSEMBLY

### TUBO CARBURANTE

### TUYAU CARBURANT

Universal. Manguera resistente al alcohol.

Universal. Alcohol resistant hose.

Universale. Tubo resistente ai solventi.

Universel. Tuyau résistant à l'alcool.

REF		
GS31096	5/16" x 2 m	1
GS31097	3/8" x 2 m	1
GS31099	8 mm x 2 m	1
SIE18-8013	5/16" x 2 m	1
SIE18-8015	3/8" x 2 m	1



REF		
GS31189	3/8" x 2 m	1



REF		
GS31183	6 mm x 2 m	1



### MANGUERA DE COMBUSTIBLE

### FUEL HOSE

### TUBO BENZINA

### TUYAU CARBURANT

Manguera «Trident» para líneas de combustible. Con refuerzo termoplástico que le permite excelente flexibilidad y resistencia a los rayos UV. Color gris. Resistente al alcohol. Especialmente indicado para motores fueraborda. Garantía: 3 años

Marine fuel hose (distribution and vent) for outboards. Fuel resistant thermo-plastic formulation with 2 spiral reinforcement provides excellent bendability and resistance to UV, aging and permeation by all marine fuels (gasoline/petrol and diesel) including alcohol blends. Warranty: 3 years

Tubo «Trident» per linea combustibile. Con rinforzo termoplastico che gli permette un'eccellente flessibilità e resistenza ai raggi UV. Colore grigio. Resistente ai solventi. Indicato per i motori fuoribordo. Garanzia: 3 anni

Tuyau «Trident» pour carburant. Avec renfort thermoplastique qui permet une excellente flexibilité et résistance aux rayons UV. Gris. Résistant à l'alcool. Convient particulièrement aux moteurs hors-bord. Garantie: 3 ans

REF				
TRI305-0566	5/16" = 7,92 mm	15 m	1	SAEJ1527
TRI305-0386	3/8" = 9,53 mm	15 m	1	ISO-8469 B1 CE



De goma para diesel y gasolina sin plomo. Ideal para fueraborda. Refuerzos textiles internos. Muy flexible. Contenido aromático 50%

Rubber Hose suitable for loading mineral oils, diesel and unloaded fuel

In gomma per diesel e benzina senza piombo. Ideale per motori fuoribordo. Tessuto interno rinforzato. Molto flessibile.

Caoutchouc pour diesel et essence sans plomb. Idéal pour le hors-bord. Renforts textiles internes. Très flexible

### CARBUPOMP/10NL

REF	Ø (mm)					
GS35031	6x12	10 bar	50 mm	-25°C → 80°C	50 m	ISO R1307
GS35032	8x15	10 bar	65 mm		50 m	

H.T. - CARBUPOMP/10NL - WP 10 BAR - R-1M Q/m - ISO R1307



**MUELLE TUBO COMBUSTIBLE**

**SPRING, FUEL PIPE**

**MOLLA TUBO COMBUSTIBILE**

**RESSORT, TUYAU DE CARBURANT**

new

REF
PAF4-04000030
PAF4-05000010



**ABRAZADERA**

**CLAMP SMALL**

**FASCETTE**

**COLLIER**

new

REF	
REC650-24351-51	6 mm
REC6E5-24351-51	8 mm



REF	OEM		
REC09401-11425	09401-11425	6-8 mm	1
REC09401-11425BULK	17822-90J00	6-8 mm	25



**ADPATADOR LÍNEA DE COMBUSTIBLE**

**COUPLER**

**ADATTATORE**

**RACCORD COUPLEUR**

REF	
REC22-8M0001721	Ø 11 mm --> Ø 9 mm



**COMPONENTES TANQUE Y CONECTORES**

**FUEL TANK COMPONENTS & CONNECTORS**

**COMPONENTI SERBATOIO E CONNETTORI**

**COMPOSANTS ET CONNEXEURS DU RÉSERVOIR**

**CONECTOR DE DEPÓSITO**

**TANK CONNECTOR**

**ATTACCO SERBATOIO**

**RACCORDS DE RESERVOIR**

Fabricado en latón.

Made in machined brass.

Fabbricato in ottone.

Coude MF 1/4" NPT en laiton.

REF		
GS31068	1/4" NPT	1



Para conectar dos motores a un sólo depósito, o viceversa. Fabricado en latón.

To connect two motors to a single tank, or vice versa. Made in machined brass.

Per collegare due motori a un singolo serbatoio o viceversa. Fabbricato in ottone.

Té en laiton, pour connecter deux moteurs à un même réservoir, ou inversement.

REF		
GS31069	1/4" NPT	1



REF	OEM	
REC65750-94404	65750-94404	GS31039 GS31038
	65750-94403	
	65750-94402	
	65750-94401	

DT4 --> DT140



new

REF	OEM	
REC65720-986L0	65720-986L0	GS31089
	65720-986A0	
	65720-986B0	

DF25 --> DF140



new

REF	OEM
REC65720-98520	65720-98520
	65720-98500
	65720-98501
	65720-98502
	65720-98521
	65720-985L1

9.9, 15 HP 4 T/-strokes  
2 --> 65 HP 2 T/-strokes



new

COMPATIBLE CON CONECTOR  
COMPATIBLE WITH CONNECTOR  
COMPATIBILE CON CONNETTORE  
COMPATIBLE AVEC CONECTEUR

REF	OEM		
GS31037	65740-99100	1/4" NPT	GS31035

2 --> 60 HP 2 T/Strokes





COMPATIBLE CON CONECTOR  
COMPATIBLE WITH CONNECTOR  
COMPATIBILE CON CONNETTORE  
COMPATIBLE AVEC CONECTEUR

REF	OEM		
GS31038	65720-94411	mm	REC65750-94404

DT75- 140 HP 2T/Strokes  
antigüos | old | vecchio | ancien





COMPATIBLE CON CONECTOR  
COMPATIBLE WITH CONNECTOR  
COMPATIBILE CON CONNETTORE  
COMPATIBLE AVEC CONECTEUR

REF	OEM		
GS31039	65720-94403	1/4" NPT	REC65750-94404

DT4--> 65 HP 2T/Strokes  
antigüos | old | vecchio | ancien





COMPATIBLE CON CONECTOR  
COMPATIBLE WITH CONNECTOR  
COMPATIBILE CON CONNETTORE  
COMPATIBLE AVEC CONECTEUR

REF	OEM		
GS31070	65740-95D00	1/4" NPT	GS31072



COMPATIBLE CON CONECTOR  
COMPATIBLE WITH CONNECTOR  
COMPATIBILE CON CONNETTORE  
COMPATIBLE AVEC CONECTEUR

REF	OEM		
GS31035	65750-98505	5/16"	GS31037
GS31036	65750-98505	3/8"	GS31037

-60HP 2 T/Strokes

Conector pequeño.  
Little connector.  
Connettore piccolo.  
Conecteur petit.





COMPATIBLE CON CONECTOR  
COMPATIBLE WITH CONNECTOR  
COMPATIBILE CON CONNETTORE  
COMPATIBLE AVEC CONECTEUR

REF	OEM		
GS31089	65750-89J11	3/8"	REC65720-986L0

DF4--> DF140 HP 4 T/Strokes





COMPATIBLE CON CONECTOR  
COMPATIBLE WITH CONNECTOR  
COMPATIBILE CON CONNETTORE  
COMPATIBLE AVEC CONECTEUR

REF	OEM		
GS31071	65750-95500	5/16"	GS31070
GS31072	65750-95500	3/8"	GS31070

60HP+ 2 T/Strokes

Conector grande.  
Big connector.  
Connettore grande.  
Conecteur grand.





REF		
GS31092	8 mm	1

Conector doble.  
Double connector.  
Connettore doppio.  
Double connecteur..





PASAMAMPAROS THRU HULL PASSASCAFO PASSE-CLOISON

Para atravesar mamparos de hasta 12 mm. Fabricado en latón. For bulkhead up to 12 mm. Made in machined brass. Per attraversare paratie fino a 12 mm. Fabbriato in ottone. Pour traverser des cloisons jusqu'à 12 mm. Fait en laiton.

REF		
GS31064	3/8"	1





## FILTRO DE COMBUSTIBLE Y ELEMENTOS

## FUEL FILTERS AND ELEMENTS

## FILTRI BENZINA E RACCORDI

## FILTRE À ESSENCE ET CARTOUCHE DE RECHANGE

### BRACKET

### BRACKET

### SUPPORTO

### TÊTE DE FILTRE À ESSENCE

Con 2 tapones de bronce y 2 tubos de extensión. (2 entradas y 2 salidas).

With 2 brass plugs and 2 extension tubes. (2 inputs & 2 outputs).

Con 2 tappi di bronzo e 2 tubi di estensione. (2 ingressi entrata carburante e 2 uscite carburante).

Avec 2 bouchons en bronze et 2 tubes d'extension. (2 entrées et 2 sorties).

REF		
REC25000	1/4"	AL
REC25010	1/4"	INOX /SS AISI316
REC25020	3/8"	AL
REC25030	3/8"	INOX /SS AISI316
RECOBBRACKET	1/4"	Plástico   Plastic Plastica   Plastique



REC25000 - REC25020



REC25010 - REC25030



RECOBBRACKET

## FILTRO COMBUSTIBLE SEPARADOR DE AGUA

## WATER SEPARATING FUEL FILTER

## FILTRO SEPARATORE ACQUA-BENZINA

## FILTRE SEPARATEUR EAU-ESSENCE

REF	MICRON	
REC24942	10	4 <sup>7</sup> / <sub>16</sub> " = 11 cm
REC35-802893Q01	10	3 <sup>3</sup> / <sub>4</sub> "
REC855686	28	4 <sup>7</sup> / <sub>16</sub> "
REC35-802893Q	25	3 <sup>3</sup> / <sub>4</sub> "
RACPF5510	10	4 <sup>7</sup> / <sub>16</sub> "

**RACOR**

**RECMAR**



RACPF5510



REC24942



REC35-802893Q01



REC855686



REC35-802893Q

Filtro original.

OEM filter.

Filtro benzina originale.

Filtre à essence d'origine

REF	MICRON	
RM35-802893Q	10	3 <sup>3</sup> / <sub>4</sub> "



## FILTRO CON BRACKET

Con 2 tapones de bronce y 1 tubo de extensión.

## OEM FILTER WITH BRACKET

With 2 brass plugs & 1 extension tube.

## FILTRO BENZINA CON SUPPORTO

Con 2 tappi di bronzo e 1 tubo di estensione.

## FILTRE À ESSENCE AVEC SUPPORT

Avec 2 bouchons en bronze et 1 tube d'extension

REF	MICRON			BRACKET
REC24950	25	1/4"	50 GPH	AL
REC24952	10	1/4"	50 GPH	AL



**RECMAR**

## FILTRO DECANTADOR DE COMBUSTIBLE COMPLETO CON VASO TRASPARENTE

## COMPLET FUEL FILTER WITH TRANSPARENT BOWL

## FILTRO DI DECANTAZIONE BENZINA COMPLETO CON VASCHETTA TRASPARENTE

## FILTRE DÉCANTEUR ESSENCE AVEC BOL TRANSPARENT

REF		
RAC320R-RAC-01		AL
RAC320R-RAC-03	RACS3213 LENS3213	Plástico Plastic Plastica Plastique

**RACOR**

REF			BRACKET
RECOFILALU			AL
RECOFILTER	RECOBELEMENT LENS3213	150 l/h	Plástico Plastic Plastica Plastique



**RECMAR**

FILTRO CON BOMBA CEBADORA

FILTER WITH PRIMING PUMP

FILTRO CON POMPETTA PER RIEMPIRE

FILTRE À ESSENCE AVEC POMPE D'AMORCAGE



REF	OEM		OEM 	MICRON			
RAC490R-RAC-01	99105-20005-ASY	RACS3227 LENS3227	99105-20005	10	340 l/h	3/8" NPTF	150 hp



FILTRO DECANTADOR GASOLINA

COMPLETE FUEL FILTER

FILTRO DECANTATORE BENZINA

FILTRE DÉCANTEUR ESSENCE

Filtro de combustible con braket.

Complete fuel filter with braket.

Filtro combustibile con supporto.

Filtre à carburant avec support.

REF		
RAC23299-10	RAC23289-10	130 HP (4 T/ Strokes)



REF	OEM		R.O. / OEM	MICRON		
REC90794-46866	65900-98J00	REC90794-46868	65910-98J00	10	117 l/h	175 hp



LLAVE PARA FILTRO  
FILTER KEY  
CHIAVE DA FILTRO  
CLÉ A FILTRE

REF  
RECYS-225-15



REF	MICRON	
PAF40-0701000EI	10	70 hp



new



## RÁCORES

## RACORS

## RACCORDI

## RACCORDS

REF			
GS31065	1/4" NPT	3/8" = 9.5 mm	1
GS31166	1/4" NPT	5/16" = 7.9 mm	2
GS31155	3/8" NPT	3/8" = 9.5 mm	2
GS31156	3/8" NPT	5/16" = 7.9 mm	2
GS31157	3/8" NPT	1/4" = 6.4 mm	2



REF			
GS31066	1/4" NPT	5/16" = 7.9 mm	2
GS31067	1/4" NPT	3/8" = 9.5 mm	2



## LLAVES PARA FILTRO

## FILTER KEY

## CHIAVE DA FILTRO

## CLÉ À FILTRE

REF	OEM
RACRK22628	99105-20003

**RACOR**



REF	OEM
REC70720	65 - 110 mm

**RECMAR**



## FILTRO COMBUSTIBLE PARA MONTAJE EN LÍNEA

## IN-LINE FUEL FILTER

## FILTRO BENZINA PER MONTARE IN LINEA

## FILTRE A ESSENCE EN LIGNE

REF				
GS31001	50 l/h	6-8 mm	plástico plastic plastica	1
GS31002	150 l/h	8-10 mm	plástico plastic plastica	1



**GOLDENSHIP**

REF	OEM
REC15410-87L00	15410-87L00
DF9.9B, DF15A, DF20A (2013)	
DF25A, DF30A (2015)	
DF90A, DF80A, DF90A (2009+)	



REF	OEM
REC15410-87J30	15410-87J30
DF20R, DF25, DF25R V2 (2006-11)	
DF40, DF50X-K10 (1999-10)	
DF60, DF70W-K9 (1998-09)	
DF90, DF100, DF115 K1-K11 (2001-11)	
DF140 (2002-12)	



REF	OEM
REC15410-96J00	15410-96J00
DF150T-Z, DF175T-Z (2006-13)	
DF150T (G)Z, DF175T (G)Z (2014)	



REF			
GS30435	6, 8, 10 mm	metal + cristal metal + crystal metallo + cristallo métal + verre	1



**GOLDENSHIP**

REF	OEM			
REC40145	40145	1/4"	1/4"	plástico
REC40155	40155	5/16"	5/16"	plastic
REC40165	40165	3/8"	3/8"	plastica
REC40135	40135	5/16"	3/8"	plastique



REF	OEM
REC15410-87J10	15410-87J10
DF25, DF30Y-K6 (2000-06)	
DF40, DF50X-K10 (1999-10)	
DF60, DF70W-K9 (1998-09)	
DF90, DF100, DF115K1-K11 (2001-11)	
DF140 (2002-11)	



REF	OEM
REC65L-24563-00	15412-93J00
DF200, DF225, DF250 (2004-11)	
DF300T-Z (2007-11)	



REF	OEM	
PAF15-07080000	15410-94400	15 - 60 hp
DT9.9K, DT15K-G-Y (1986-00)		
DT25C, DT30C-K-Y (1989-00)		
DT20, DT25, DT30G-Y (1986-00)		
DT55, DT65J-X (1988-99)		
DT40C-W-G-X (1986-99)		
DT5, DT6, DT8G-Y (1986-00)		



SUZUKI

RECAMBIOS MARINOS

REF	OEM
REC15410-98500	15410-98500

  
 DF4, DF5, DF6 (2002-14)  
 DF8A, DFAR, DF9.9A, DF9.9AR (2010+)  
 DF9.9, DF15T-K3 (1996-03)  
 DF9.9, DF15 (R) (2004-12)  
 DF40, DF50X-K10 (1999-10)  
 DF60, DF70W-K9 (1998-09)  
 DF150T-Z, DF175T-Z (2006-11)

REF	OEM
REC15412-92J00	15412-92J00

  
 DF100A, DF115, DF140A (2013+)  
 DF150, DF175, DF200 A/AP/AT (2015+)  
 DF70A, DF80A, DF0A, DF100B (2018+)

REF	OEM
REC90794-46868	65910-98J00

  
 DF8 --> DF300  
 DT9.9 40HP

REF	OEM
REC69J-24501-10	15643-93J00

  
 DF200, DF225, DF250 (2004+)  
 DF250AP, DF300AP (2013+)  
 DF300T/Z (2007-11)  
 DF300AP (2012)

REF	OEM
REC15410-88L00	15410-88L00

  
 DF40A, DF50A, DF60A (2010+)

REF	OEM
REC15412-93J10	15412-93J10

  
 DF200, DF225, DF250 (2004+)  
 DF250AP, DF300AP (2015+)  
 DF300T/F (2004-11)  
 DF350A, DF325A (2018+)

REF	OEM
REC15410-93J00	15410-93J00

  
 DF200, DF225, DF250 (2004-11)  
 DF300T/Z (2007-11)

REF	OEM
REC16910-GB2-005	15410-94350

  
 DT40C-W-G-X (1986-99)  
 DT40WK1-K4 (2001-04)  
 DT5Y (1998-02)  
 DT9.9, DT15K1-K4 (2001-04)  
 DT9.9K, DT15KG-Y (1986-00)

**FILTRO COMBUSTIBLE ALTA PRESION**

**HIGH PRESSURE FUEL FILTER**

REF	OEM
REC15410-87J00	15410-87J10

  
 DF40, DF50X-K10 (1999-10)

**FILTRO BENZINA ALTA PRESSIONE**

**FILTRE À ESSENCE HAUTE PRESION**

REF	OEM
REC15440-96J00	15440-96J00

  
 DF150T/Z, DF175T/Z (2006-11)

REF	OEM
REC15440-87L10	15440-87L10

  
 DF70A, DF80A, DF90A (2009-12)

REF	OEM
REC15440-90J00	15440-90J00

  
 DF90, DF100, DF115 (2002-11)  
 DF140 (2002-12)

REF	OEM
REC15440-96J01	15440-96J01

  
 DF150, DF175, DF200 A/P (2015+)  
 DF150, DF175, DF200 G/Z/AT (2006+)

REF	OEM
REC15440-93J00	15440-93J00

  
 DF200, DF225, DF250 (2004-18)  
 DF250AP, DF300AP (2012+)  
 DF300T/Z (2007-11)

REF	OEM
REC15440-99E01	15440-99E01 15440-99E00

DF60, DF70W-K9 (1998-09)



**new**

**FILTRO DE ACEITE OIL FILTER FILTRO OLIO FILTRE À HUILE**

REF	OEM
REC16510-05240	16510-45H10 16510-05240

DF8A-AR, DF9.9A-AR (2010+)  
DF9.9, DF15T-K3 (1996-03)  
DF9.9, DF115(R) (2004-11)  
DF9.9B, DF15A, DF20A (2013)  
DF15 (2012)



REF	OEM
REC09280-54001	09280-54001 09280-56001

REF	OEM
REC16510-87J00	16510-87J00 16510-87JL0

DF20R, DF25-R-V2 (2006-11)  
DF25, DF30Y-K6 (2000-06)  
DF40, DF50X-K10 (1999-10)  
DF40A, DF50A, DF60A (2010+)  
DF60, DF70W-K9 (1998-09)



REF	OEM
REC16510-82703	16510-82703 16510-92J00 16510-81420

DF140 (2002-12)  
DF115WT, DF140WT-K3 (2003)



REF	OEM
REC16510-90J00	16510-90J00 16510-61A30 16510-61A31 16510-61A01 16510-61A20-MHL 16510-61A21-MHL

DF70A, DF80A, DF90A (2009-11)  
DF90, DF100, DF115 K1-K11 (2001-11)  
DF115WT, DF140WT-K3 (2001-11)



REF	OEM
REC16510-96J00	16510-96J00
REC16510-93J00	16510-96J10

DF150T-Z, DF175T-Z (G) (2006+)  
DF150AP, DF175AP, DF200AP (2018+)  
DF150AT, DF175AT, DF200AT (2019)  
DF200, DF225, DF250 (2004+)  
DF200A (2015+)  
DF300AP (2012+)  
DF300T-Z (2007-11)  
DF350A, DF325A (2018+)



REC16510-93J00 CAMBIA | CHANGE | CAMBIA | CHANGE --> REC16510-96J00

**GUÍA FILTROS DE ACEITE OIL FILTER GUIDE GUIDA FILTRO OLIO GUIDE FILTRE À HUILE**

REF	REF
DF9.9, 9.9TH, 9.9A, 9.9B, 15, 15A, 20A	1996+ REC16510-05240
DF25, 25V Twin, 25A, 30, 30A	REC16510-87J00
DF40, 40A, 50, 50A, 60, 60A, 70	REC16510-87J00
DF70A, 90A	2009+ REC16510-90J00
DF90, 115	REC16510-90J00

REF	REF
DF115A, DF140A	REC16510-90J00
DF140	REC16510-82703
DF150, 175, 200A	REC16510-96J00 REC16510-93J00
DF200, 225, 250, 300, 350	REC16510-96J00 REC16510-93J00

**JUNTA TAPÓN DE CÁRTER OIL DRAIN PLUG GASKET GUARNIZIONE, TAPO COPPA L'OLIO JOINT DE VIDANGE**

REF	OEM
REC09168-12012	09168-12012

DF25 --> DF350



**new**

REF	OEM
REC09168-12017	09168-12017

DF4 --> DF30



**new**

ACEITE

OIL

OLIO

HUILES

REF			
REC2TU6	1 L	6	2 STROKES
REC2TU3	5 L	3	TC-W3
REC5W40U6	1 L	6	SAE 5W40
REC5W40U3	5 L	3	
REC10W30U6	1 L	6	SAE 10W30
REC10W30U3	5 L	3	
REC10W40U6	990CO-01E30-GLN 990CO-10W40-1GL	1 L	6
REC10W40U3	990CO-10W40-GAL 990CO-10W40-GLN	5 L	3
REC25W40U3		5 L	3 SAE 25W40
REC80W90U3		5 L	3 SAE 80W90
REC80W90U6	990A0-01E81-01Q	1 L	6 SAE 80W90



REF			
RM92-858026QB1U6	1 L	6	2 STROKES
RM92-858027QB1U3	3,8 L	3	
RM92-8M0086220U6	1 L	6	SAE 10W30
RM92-8M0086221U3	4 L	3	



RM92-858026QB1U6 RM92-858027QB1U3 RM92-8M0086220U6 RM92-8M0086221U3

BOMBA DE COMBUSTIBLE

FUEL PUMP

POMPA BENZINA

POMPE À ESSENCE

BOMBA DE COMBUSTIBLE MECANICA

FUEL PUMP MECHANICAL

POMPA BENZINA MECCANICA

POMPE À ESSENCE MECANIQUE

REF	OEM	2T STROKES	4T STROKES
PAF4-04090000	15100-91J00 15100-91J01 15100-91J02		✓

DF4, DF5, DF6 (2002+)



REF	OEM	2T STROKES	4T STROKES
REC692-24410-00	15100-94311 15100-94301 15100-94303 15100-94310		✓

DT20, DT25, DT30G-Y (1986-00)  
DT25C, T30C K-Y (1989-00)  
DT40C-W G-X (1986-99)  
DT55, DT65 J-X (1988-99)  
DT8, D9.9C J-V (1988-99)  
DT25, DT30 K1-K2 (2001-02)  
DT40W K1-K4 (2001-04)



BOMBA DE COMBUSTIBLE ELECTRICA

FUEL PUMP ELECTRIC

POMPA BENZINA ELETTRICA

POMPE À ESSENCE ELECTRIQUE

REF	OEM	2T STROKES	4T STROKES
REC63P-13907-03	15200-90J00 15200-92J00 15200-93J01		✓

DF70A, DF80A, DF90A (2009-12)  
DF90, DF100, DF115 (2001-11)  
DF140 (2002-12)  
DF100A, DF115A (2013)  
DF100A, DF115A, DF140A (2014+)  
DF140A (2013)  
DF7A, DF80A, DF90A (2014+)  
DF200, DF225, DF250 (2004+)



REF	OEM	2T STROKES	4T STROKES
REC15200-96J00	15200-96J00		

DF150, DF175T/Z (G) (2014)  
DF150, DF175T/Z (2006-13)  
DF200A (2015)



**KITS MEMBRANAS Y JUNTAS**      **DIAPHRAGMS & GASKETS SETS**      **KIT MEMBRANA E GUARNIZIONI**      **KIT MEMBRANES ET JOINTS**

REF	OEM
REC15170-93911	15170-93920

DT9.9K, DT15K-G-Y (1986-00)  
DT9.9, DT15K1-K4 (2001-04)  
DT8, DT9.9C-J-V (1988-97)  
DT15C (1989-97)

REF	OEM
REC15170-98110	15170-98110

DT4, J4, DT5Y (1988-00)  
DT4 K1 (2001)  
DT5Y (1998-02)  
DT5, DT6, DT8G-Y (1986-00)  
DT6, DT8Y-K2 (2000-02)

REF	OEM
REC15170-94320	15170-94320

DT20, DT25, DT30G-Y (1986-00)  
DT25, DT30 K1-K2 (2001-02)  
DT25C, DT30C K-Y (1989-00)  
DT40C-W-G-X (1986-99)  
DT40W-K1-K4 (2001-04)  
DT55, DT65J-X (1988-99)

REF	OEM
REC15170-91J00	15170-91J00

DF4, DF5, DF6 (2002-11)

REF	OEM
REC15170-94J00	15170-94J00

DF8A, DF8AR, DF9.9A, DF9.9AR (2010-11)  
DF9.9, DF15 (R) (2004-11)

REF	OEM
REC15170-99E00	15170-99E00

DF9.9, DF15R-K3 (1996-03)  
DF25, DF30Y K6 (2000-06)  
DF40, DF50Z-K10 (1999-10)  
DF60, DF70W-K9 (1998-09)

**JUNTAS VST**      **VST GASKETS**      **GUARNIZIONE VST**      **JOINTS VST**

REF	OEM
REC15626-99E00	15626-99E00 15643-99E00

DF40, DF50 X-K10 (1999-10)  
DF60, DF70 W-K9 (1998-09)

**new**

REF	OEM
REC15626-90J00	15626-90J00

DF70A, DF80A, DF90A (2009-12)  
DF90, DF100, DF115 (2001-11)  
DF140 (2002-12)  
14002F  
14002Z

**new**

**INYECTORES**      **INJEKTOR**      **INIETTORE**      **INJECTEURS**

**INYECTOR**      **INJEKTOR**      **INIETTORE**      **INJECTEUR**

REF	OEM
REC15710-66D00	15710-66D00

**new**

REF	OEM
REC15710-87L00	15710-87L00

**new**

REF	OEM
REC15710-65D00	15710-65D00

**new**

REF	OEM
REC15710-89L00	15710-89L00 15710-50M00

**new**

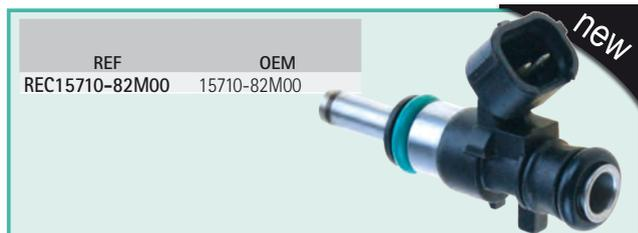

**GUÍA INYECTORES Y SENSORES**

**GUIDE INJECTORS & SENDERS**

**GUIDA INIETTORI E SENSORI**

**GUIDE INJECTEURS ET SONDÉS**

			MAP	IAC VALVE			MAP	IAC VALVE
DF9.9B	2013+	REC15710-89L00	REC18590-58M00		DF115WT	2008+	REC15710-65D00	REC18590-68H00
DF15A	2013+	REC15710-89L00	REC18590-58M00		DF115	2008-11	REC15710-65D00	REC18590-72F21
DF20A	2013+	REC15710-89L00	REC18590-58M00		DF115A	2013+	REC15710-82K50	REC18590-68H00
DF25A	2015+	REC15710-82M00	REC18590-58M00		DF140A	2002-12	REC15710-65D00	REC18590-68H00
DF30A	2015+	REC15710-82M00	REC18590-58M00		DF140WT K3	2003-07	REC15710-65D00	REC18590-72F21
DF40	1999-10	REC15710-87J00			DF140WT K3	2008+	REC15710-65D00	REC18590-68H00
DF40A	2010+	REC15710-85K00		REC18137-88L01	DF140A	2013+	REC15710-82K50	REC18590-68H00
DF50	1999-01	REC15710-87J00			DF150T/Z	2006-12	REC15710-96J00	REC18590-68H00
DF50A	2010+	REC15710-85K00		REC18137-88L01	DF150 T/Z (G)	2013+	REC15710-96J00	REC18590-68H00
DF60 (S/N 971543-)	1998-09	REC15710-99E00			DF150AP	2017+	REC15710-96J00	REC18590-68H00
DF60 (S/N 971544+)	1998-09	REC15710-66D00			DF150AT	2019	REC15710-96J00	REC18590-68H00
DF60A	2010+	REC15710-85K00		REC18137-88L01	DF175T/Z	2006-12	REC15710-96J00	REC18590-68H00
DF70 (S/N 971543-)	1998-09	REC15710-99E00			DF175 T/Z (G)	2013+	REC15710-96J00	REC18590-68H00
DF70 (S/N 971544+)	1998-09	REC15710-66D00			DF175AP	2017+	REC15710-96J00	REC18590-68H00
DF70A	2009-11	REC15710-87L00	REC18590-68H00	REC18137-87L01	DF175AT	2019	REC15710-96J00	REC18590-68H00
DF70A	2012+	REC15710-82K50	REC18590-68H00	REC18137-87L01	DF200	2004-12	REC15710-96J00	REC18590-68H00
DF80A	2009-11	REC15710-87L00	REC18590-68H00	REC18137-87L01	DF200	2014+	REC15710-93J00	REC18590-68H00
DF80A	2012+	REC15710-82K50	REC18590-68H00	REC18137-87L01	DF200A	2015-17	REC15710-96J00	REC18590-68H00
DF90	2001-07	REC15710-65D00	REC18590-68H00		DF200AP	2015+	REC15710-96J00	REC18590-68H00
DF90A	2009-11	REC15710-87L00	REC18590-68H00	REC18137-87L01	DF200AT/AZ	2018+	REC15710-96J00	REC18590-68H00
DF90A	2012+	REC15710-82K50	REC18590-68H00	REC18137-87L01	DF225	2004-12	REC15710-96J00	REC18590-68H00
DF100	2001-07	REC15710-65D00	REC18590-68H00		DF225	2014+	REC15710-93J00	REC18590-68H00
DF115	2001-07	REC15710-65D00	REC18590-68H00		DF250AP	2013-18	REC15710-96J00	REC18590-68H00
DF90	2008-11	REC15710-65D00	REC18590-72F21		DF250	2004-12	REC15710-96J00	REC18590-68H00
DF100	2008-11	REC15710-65D00	REC18590-72F21		DF250	2014+	REC15710-93J00	REC18590-68H00
DF100A	2013+	REC15710-82K50	REC18590-68H00		DF300T/Z	2007-11	REC15710-96J00	REC18590-68H00
DF115WT	2003-07	REC15710-65D00	REC18590-72F21		DF300AP	2012-18	REC15710-96J00	REC18590-68H00
					DF325A	2018+		REC18590-68H00
					DF350A	2018+		REC18590-68H00



**CARBURADOR      CARBURATOR      CARBURATORE      CARBURATEUR**

**CARBURADOR COMPLETO      FULL CARBURATOR      CARBURATORE COMPLETO      CARBURATEUR COMPLET**

REF	OEM
REC13200-91J70	13200-91J70
 DF4, DF5, DF6 (2002-11)	



REF	OEM
REC13200-91D21	13200-91D21 13200-91D20
 DT9.9, DT15 K1-K4 (2001-04) DT9.9K, DT15KG-Y (1986-00)	



**KITS CARBURADORES      CARBURETOR KITS      KIT CARBURATORI      KIT CARBURATEUR**

REF	OEM
REC13910-87D00	13910-87D00
 V6 MODELS (2T/STROKE)	



REF	OEM
REC13910-94701	13910-94701
 DT55 DT75 DT115	



REF	OEM
REC13910-94400	13910-94400
 DT40 DT65 DT85 DT140	



REF	OEM
REC13910-89J01	13910-89J01
 DF25 (EXC V-TWIN)	



**BOYAS      FLOATS      GALLEGGIANTE      FLOTTEUR DE CARBURATEUR**

REF	OEM
REC13250-95D01	13250-95D01
 DF9.9, DF15 T-K3 (1996-03) DF9.9, DF15(R) (2004-11) DT25C, DT30C K-Y (1989-00)	



# SISTEMA ELÉCTRICO ELECTRIC SYSTEM

# SISTEMA ELETTRICO SYSTEME ELECTRIQUE

## SENSORES

## SENSORS

## SENSORE

## CAPTEURS

### SENSOR MAP

### MAP SENSOR

### SENSORE MAP

### CAPTEUR MAP

REF	OEM
REC18590-68H00	18590-68H00



**new**

REF	OEM
REC18590-58M00	18590-58M00



**new**

REF	OEM
REC18590-72F21	18590-72F21



**new**



### SENSOR IAC

### IAC SENSOR

### SENSORE IAC

### CAPTEUR IAC

REF	OEM
REC18137-93J00	18137-93J00
REC18137-52D00	18137-52D00
REC18137-88L01	18137-88L01
REC18137-87L01	18137-87L01



**new**

REF	OEM
REC13650-52G00	13650-52G00

DF9.9 --> DF350



**new**

REF	OEM
REC13650-56B00	13650-56B00

DF60, DF70W-K9 (1998-09)



**new**

### SENSOR CMP

### CMP SENSOR

### SENSORE CMP

### CAPTEUR CMP

REF	OEM
REC33220-76G02	33220-76G00 33220-76G01 33220-76G02

DF40, DF50X-K10 (1999-10)  
DF90, DF100, DF115 (2001-11)  
DF140 (2002-12)  
DF115, DF140WT (2003)



**new**

REF	OEM
REC33220-58J20	33220-58J20

DF150, DF175 (G)Z/T (2014)  
DF150, DF175T/Z (2006-13)  
DF40A, DF50A, DF60A (2009-12)  
DF70A, DF80A, DF90A (2012)



**new**



## BOBINAS

## COILS

## BOBINE

## BOBINES

### BOBINA

### COIL

### BOBINA

### BOBINE

REF	OEM
REC33410-94400-000	33410-94400-000 33410-93E10

 DF9.9, DF15T -K3 (1996-03)  
 DF9.9, DF15(R)' (2004-10)  
 DT40C-W-G-X (1986-99)  
 DT40W-K1-K4 (2001-04)



REF	OEM
REC32140-94400	32140-94400

 DT40C-WG-X (1986-99)  
 DT40W K1-K4 (2001-04)

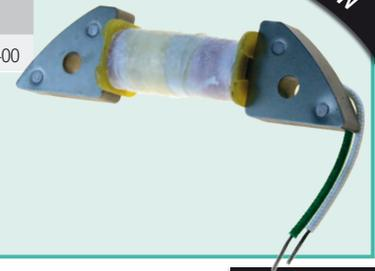

REF	OEM
REC32900-96340	32900-96340

 DT20, DT25, DT30G-Y  
 (1986-00)



REF	OEM
REC32140-96310	32140-96310

 DT20, DT25, DT30G-Y (1986-00)  
 DT25, DT30 K1-K2 (2001-02)



REF	OEM
REC32900-93903	32900-93903 32900-93902

 DT9.9K, DT15G-Y (1986-00)



REF	OEM
REC32140-93900	32140-93900

 DT9.9, DT15K1-K4 (2001-04)  
 DT9.9K, DT15K-G-Y (1986-00)



### REGULADOR-BOBINA

### REGULATOR-COIL

### REGOLATORE-BOBINA

### REGULATEUR-BOBINE

REF	OEM
REC32900-94480	32900-94401 32900-94421 32900-94480

 DT40C-W-X-G (1986-99)



## BUJÍAS

## SPARK

## CANDELE

## BOUGIES



REF NGK	RO / OEM
DF2.5, DF6	NGKCR6HSA 09482-00406
DF4, DF6	2003-10 NGKBPR6ES 09482-00299
DF4, DF6	2011+ NGKCPR6EA-9 09482-00L04
DF9.9A	NGKCR6E 09482-00528
DF9.9, DF15	2004- NGKDCPR6E 09482-00446
DF9.9, DF15	2004-10 NGKBKR6E 09482-00427
DF9.9, DF15	2010+ NGKCPR6EA-9 09482-00L04
DF25A, DF30A	NGKDCPR6E 09482-00446
DF25 V-TWIN	NGKBKR6E 09482-00427
DF40, DF50	NGKDCPR6E 09482-00446



REF NGK	RO / OEM
DF60, DF70	NGKBPR6ES 09482-00299
DF40A, DF50A, DF60A	NGKDCPR6E 09482-00446
DF70A, DF90A	NGKDCPR6E 09482-00446
DF90, DF115, DF140	NGKBKR6E 09482-00427
DF150, DF175	NGKBKR6E 09482-00427
DF200A, DF200AP	NGKLR6E 09482-00649
DF200, DF225, DF250	NGKBKR6E 09482-00427
DF200SS	NGKBKR6E 09482-00427
DF300	NGKBKR6E 09482-00427





2T STROKES	REF NGK	2T STROKES	REF NGK	2T STROKES	REF NGK
DT2	1986-90	NGKBR4HS	DT30	1983-85	NGKBR7HS-10
DT2	1991-99	NGKBR5HS	DT30C	1988-00	NGKBR7HS-10
DT2.2	1992	NGKBR5HS	DT30E	1983	NGKBR7HS-10
DT4	1988-92	NGKBP5HS	DT40	-1983	NGKB8HS
DT4	1993-01	NGKBP5HS	DT40C	1986-99	NGKB8HS-10
DT4.5		NGKBR6HS	DT40C/CR/TC	1998	NGKB8HS-10
DT4L/S	1994	NGKBP5HS	DT40W	1995	NGKB7HS-10
DT4L/S	-1993	NGKBP5HS	DT40WK	1998	NGKB7HS-10
DT5	1986-92	NGKBP6HS	DT40WK	-1997	NGKB7HS
DT5	1993-94	NGKBP6HS	DT48M	2001	NGKB8HS-10
DT5	1995-00	NGKBR6HS	DT48M	-2000	NGKB8HS
DT5W	1986-92	NGKBR6HS	DT50	1979-83	NGKB8HS
DT5Y	1998-01	NGKBP7HS-10	DT50	-1978	NGKB7HS
DT6	1986-92	NGKB6HS-10	DT50	1984-89	NGKB8HS-10
DT6	1993-02	NGKBR6HS	DT50ACR	1994-96	NGKB8HS-10
DT6	-1985	NGKB6HS	DT50ACR	1993	NGKBR8HS
DT6	1995-99	NGKBR6HS-10	DT50C	1984-00	NGKB8HS-10
DT6S/5PS	-1992	NGKB6HS	DT50K		NGKB7HS
DT7.5		NGKBR6HS	DT50M/DT50	1986-89	NGKB8HS-10
DT8	1986-02	NGKBP6HS	DT50M/DT50	-1985	NGKB8HS
DT8C	1988-97	NGKBR6HS-10	DT50M/DT50	2001	NGKBR8HS-10
DT9		NGKB6HS-10	DT55C	1988-98	NGKBR8HS-10
DT9.9	1986-99	NGKBR7HS-10	DT55M/MQ	-2000	NGKB8HS
DT9.9	1977-78	NGKB7HS	DT55M/MQ	2001	NGKBR8HS-10
DT9.9	1879-84	NGKBR6HS	DT55TC/CRQ	1998	NGKBR8HS-10
DT9.9	1976	NGKB6HS	DT60		NGKB8HS-10
DT9.9C	1988-97	NGKBR6HS-10	DT60C	2001	NGKBR8HS-10
DT9.9E	1982	NGKB6HS	DT60C	1986-87	NGKB8HS-10
DT9.9E	1984	NGKB7HS	DT65/T	-1983	NGKBR8HS
DT9.9E	1983	NGKBR7HS-10	DT65C	1988-99	NGKBR8HS-10
DT9.9K	1985-86	NGKB6HS	DT65TC	1994-95	NGKBR8HS-10
DT9.9K	-1985	NGKBR6HS	DT75/85	1990-92	NGKB8HS
DT9.9K	1986-90	NGKB6HS	DT75/85	1993-00	NGKBR8HS-10
DT9.9P	-1983	NGKBP6HS	DT75C	2001	NGKBR8HS-10
DT15	1986-02	NGKBR7HS-10	DT75C	1993-00	NGKB8HS
DT15C	1989-97	NGKBR7HS-10	DT75M	2001	NGKBR8HS-10
DT15K	-1985	NGKBR6HS	DT75M	-2000	NGKBR8HS
DT15K	1986	NGKB6HS	DT75TC	-2000	NGKB8HS
DT20	1997-00	NGKBR7HS-10	DT75TC	2001	NGKBR8HS-10
DT20/P	-1985	NGKBR7HS	DT85	-1992	NGKBR8HS
DT20/P	1986	NGKBR7HS-10	DT85C	2001	NGKBR8HS-10
DT20K	-1985	NGKBR7HS-10	DT85C	1993-00	NGKBR8HS
DT20K	1986-87	NGKB7HS-10	DT85C	-1992	NGKBR8HS
DT25	-1985	NGKBR7HS	DT85M	2001	NGKBR8HS-10
DT25	2000-01	NGKBR7HS-10	DT85M	-2000	NGKBR8HS
DT25C	1989-97	NGKBR7HS-10	DT85MQ	1995-96	NGKB8HS-10
DT25E	1983-85	NGKBP7HS-10	DT85Q	2001	NGKBR8HS-10
DT25E	-1982	NGKB7HS	DT85Q	-2000	NGKBR8HS
DT25E	1986	NGKBR7HS-10	DT85TC	-2000	NGKB8HS
DT25K	1986	NGKBR7HS-10	DT85TC	2001	NGKBR8HS-10
DT28/P/E		NGKB7HS	DT85W	2001	NGKB8HS-10
DT30	1986	NGKBR7HS-10	DT85W	-2000	NGKBR8HS
DT85WT	2001	NGKB8HS-10	DT85WT	1995-96	NGKB8HS-10
DT90TC	1996-97	NGKBR8HS	DT90	-2000	NGKBR8HCS-10
DT100	1990-95	NGKBR8HCS-10	DT90TC	1998	NGKBR8HS-10
DT100	2000	NGKBR8HCS-10	DT90TC	-1995	NGKBR8HCS-10
DT100TC	-1995	NGKBR8HCS-10	DT90TC	1998	NGKBR8HS-10
DT100TC	1998	NGKBR8HS	DT100	2001	NGKBR8HS-10
DT100TC	1996-97	NGKBR8HS	DT100	1996-00	NGKBR8HS-10
DT115	-1990	NGKB8HS	DT100	1990-95	NGKBR8HCS-10
DT115	1992	NGKBR8HCS-10	DT100	2000	NGKBR8HCS-10
DT115C	1991-93	NGKBR8HCS-10	DT100TC	-1995	NGKBR8HCS-10
DT115C	-1990	NGKB8HS	DT100TC	1998	NGKBR8HS-10
DT115C	2001	NGKBR8HS-10	DT100TC	1996-97	NGKBR8HS
DT115S	1996	NGKBR8HS-10	DT115	-1990	NGKB8HS
DT115TC	1996	NGKBR8HS-10	DT115	1992	NGKBR8HCS-10
DT115TC	-1988	NGKB8HS-10	DT115C	1991-93	NGKBR8HCS-10
DT115TC		NGKBR8HCS-10	DT115C	-1990	NGKB8HS
DT115TC (EFI)		NGKBR8HS-10	DT115C	2001	NGKBR8HS-10
DT140	1992	NGKBR8HS-10	DT115S	1996	NGKBR8HS-10
DT140	-1990	NGKB8HS	DT115TC	1996	NGKBR8HS-10
DT140	1996	NGKBR8HS-10	DT115TC	-1988	NGKB8HS-10
DT140C	1991-96	NGKBR8HCS-10	DT115TC		NGKBR8HCS-10
DT140C	-1990	NGKB8HS	DT115TC (EFI)		NGKBR8HS-10
DT140C	1997	NGKBR8HCS-10	DT140	1992	NGKBR8HS-10
DT140T	-2000	NGKBR8HCS-10	DT1140	-1990	NGKB8HS
DT140T	2001	NGKBR8HS-10	DT140	1996	NGKBR8HS-10
DT140TC	-2000	NGKBR8HCS-10	DT140C	1991-96	NGKBR8HCS-10
DT140TC		NGKBR8HS-10	DT140C	-1990	NGKB8HS
DT150	1987-02	NGKBR8HS-10	DT140C	1997	NGKBR8HCS-10
DT150G		NGKBR8HS-10	DT140T	-2000	NGKBR8HCS-10
DT150S		NGKBR8HS-10	DT140T	2001	NGKBR8HS-10
DT150SS		NGKBR8HS-10	DT140TC	-2000	NGKBR8HCS-10
DT150STC		NGKBR8HS-10	DT140TC		NGKBR8HS-10
DT150TC	1989	NGKBR8HS-10	DT150	1987-02	NGKBR8HS-10
DT150TC		NGKBR8HS-10	DT150G		NGKBR8HS-10
DT175	1989-02	NGKBR8HS-10	DT150S		NGKBR8HS-10
DT175TC	-1988	NGKB8HS-10	DT150SS		NGKBR8HS-10
DT175TC	1989	NGKBR8HS-10	DT150STC		NGKBR8HS-10
DT200	1989-02	NGKBR8HS-10	DT150TC	1989	NGKBR8HS-10
DT200G		NGKBR8HS-10	DT150TC		NGKBR8HS-10
DT200T		NGKBR8HS-10	DT175	1989-02	NGKBR8HS-10
DT200TC	1989	NGKBR8HS-10	DT175TC	-1988	NGKB8HS-10
DT200V		NGKBR8HS-10	DT175TC	1989	NGKBR8HS-10
DT225	1991-02	NGKBR8HS-10	DT200	1989-02	NGKBR8HS-10
DT225TC		NGKBR8HS-10	DT200G		NGKBR8HS-10
DT225TCL		NGKBR8HS	DT200T		NGKBR8HS-10
			DT200TC	1989	NGKBR8HS-10
			DT200V		NGKBR8HS-10
			DT225	1991-02	NGKBR8HS-10
			DT225TC		NGKBR8HS-10
			DT225TCL		NGKBR8HS

SUZUKI

RECAMBIOS MARINOS

2T STROKES	REF CHAMPION	
DT2	1977-96	CHAL90C
DT2.2	1997	CHAL90C
DT3.5	1979-84	CHAQL87YC
DT4	1985-98	CHAQL87YC
DT4.5	1977	CHAQL86C
DT5	1978-83	CHAQL87YC
DT5Y	1999-01	CHAQL82YC
DT6	1984-97	CHAQL87YC
DT6	1998-01	CHAQL87YC
DT7.5	1977-79	CHAQL86C
DT8	1980-87	CHAQL87YC
DT9	1977-79	CHAQL86C
DT9	1993	CHAQL86C
DT9.9C	1983-97	CHAQL82C
DT15	1983-88	CHAQL86C
DT15C	1989-97	CHAQL82C
T16	1977-82	CHAQL86C
DT20	1977-88	CHAQL82C
DT25C	1977-00	CHAQL82C
DT30C	1989	CHAQL82C
DT35	1989	CHAQL82C

2T STROKES	REF CHAMPION	
DT40	1980-98	CHAQL78C
DT50	1997-84	CHAQL78C
DT55	1985-97	CHAQL78C
DT60	1983-84	CHAQL78C
DT65	1978-97	CHAQL78C
DT75	1983-97	CHAQL78C
DT85	1979-97	CHAQL78C
DT85	1998	CHAQL78C
DT90 V4	1989-97	CHAQL78C
DT100 V4	1989-01	CHAQL78C
DT115 Carb	1981-97	CHAQL78C
DT115 EFI	1996-01	CHAQL78C
DT115S EFI	1998	CHAQL78C
DT140 Carb	1981-96	CHAQL78C
DT140 EFI	1997-01	CHAQL78C
DT150 V6 EFI	1986-94	CHAQL78C
DT175 V6	1991-93	CHAQL78C
DT200 EFI	1986	CHAQL78C
DT225 EFI	1991	CHAQL78C

4T STROKES	REF CHAMPION	
DF4	2003-04	CHARN9YC
DF6	2003-04	CHARN9YC
DF9.9	1997-04	CHARA8HC
DF15	1997-04	CHARA8HC
DF25	2000-04	CHARA8HC
DF30	2000-04	CHARA8HC
DF40	1999-04	CHARA8HC
DF50	1999-04	CHARA8HC
DF60	1998-04	CHARN9YC
DF70	1998-04	CHARN9YC
DF90	2001-04	CHARC9YC
DF115	2001-04	CHARC9YC
DF140	2002-04	CHARC9YC

REF  
CHAPROSUP  
49REF  
RECO04

# MOTORES DE ARRANQUE

# STARTERS

# MOTORINI AVVIAMENTO

# DEMARREURS

## MOTORES DE ARRANQUE

## STARTERS

## MOTORINI AVVIAMENTO

## DEMARREURS

REF	OEM	⚡	☀️	2T STROKES	4T STROKES
PH130-0006	31100-96310	12V	0.6 kw	9 CCW	✓ ✓
	31100-96311				
	31100-94400				
	31100-94401				
	31100-94402				
	31100-89J00				



DF9.9, DF15 (1996-11)  
DF25, DF30Y-K6 (2000-06)  
DF25A, DF30A (2015+)  
DT20, DT25, DT30G-Y (1986-00)  
DT25, DT30 (1998-00)  
DT40C-WG-X (1986-99)



REF	OEM	⚡	☀️	2T STROKES	4T STROKES
PH130-0060	31100-95600	12V	0.9 kW	8	✓
	31100-95601				
	31100-95310				
	31100-95312				
	31100-95313				
	31100-95521				



DT75-DT85Y-J (1988-00)



REF	OEM	⚡	☀️	2T STROKES	4T STROKES
PH130-0053	31100-94600	12V	0.9 kW	9 CCW	✓
	31100-94601				
	31100-94610				
	31100-94500				
	31100-94510				
	31100-94511				



DT115, DT140G-Y (1986-00)



REF	OEM	⚡	☀️	2T STROKES	4T STROKES
PH130-0052	31100-87000	12V	0.9 kW	8	✓
	31100-87D00				
	31100-87D10				
	31100-92E00				



DT90, DT100L - Y (1990-00)  
DT150, DT200, DT225W-K3 (1998-03)  
V6H-Y (1987-00)



REF	OEM	⚡	☀️	2T STROKES	4T STROKES
PH130-0007	31100-95240	12V	1 kW	9 CCW	✓
	31100-95242				
	31100-95243				
	31100-95243				



DT50 (1980-83)  
DT65 (1980-82)



REF	OEM	⚡	☀️	2T STROKES	4T STROKES
PH130-0077	31100-95J00	12V	9 CCW	✓	
	31100-95J01				
	31100-94J10				
	31100-94J20				
	31100-94J21				
	31100-94J22				



DF8A, DF9.9A (AR) (2010-16)  
DF9.9, DF15 (R) (2004-11)  
DF9.9B, DF15A, DF20A (2013)  
DF15 (2012)  
DF20R (2006-2011)  
DF25, DF25R-V2 (2006-11)  
DF40, DF50X-K10 (1999-10)  
DF40A, DF50A, DF60A (2010-18)



REF	OEM	⚡	☀️	2T STROKES	4T STROKES
PH130-0075	31100-94702	12V	1.4 kW	9	✓



DT55, DT65X-J (1988-99)



REF	OEM	⚡	☀️	2T STROKES	4T STROKES
PH130-0071	31100-90J00	12V	1.4 kW	9 CCW	✓
	31100-90J01				



DF90, DF100, DF115K1-K11 (2001-1)  
DF100A, DF115A, DF140A (2013+)  
DF140 (2002-12)  
DF140A (2013)



REF	OEM	⚡	☀️	2T STROKES	4T STROKES
PH130-0079	31100-87J00	12V	8		✓
	31100-87J10				
	31100-87J11				
	31100-87500				

 DF40, DF50X-K10 (1999-10)  
 DF60, DF70W-K9 (1998-09)



REF	OEM	⚡	☀️	2T STROKES	4T STROKES
PH130-0078	31100-96J01	12V	9		✓
	31100-96J00				
	31100-93J00				
	31100-98L00				
	31100-98L10				

 DF70A, DF80A, DF90A (2009+)  
 DF70A, DF80A, DF90A - 100B (2018+)  
 DF150AP, DF175AP, DF200AP (2018+)  
 DF150AT, DF175AT, DF200AT (2019)  
 DF150T/Z, DF175T/Z (2018)  
 DF150G/T/Z (2006+)  
 DF175G/T/Z (2006+)  
 DF200, DF225, DF250 (2004-12, 2019)  
 DF200AT/AZ (2018)  
 DF250AP, DF300AP (2018+)  
 DF300T/Z (2007-2011)  
 DF300AP (2012)  
 DF350, DF325A (2018+)



**SOLENOIDE PARA MOTOR DE ARRANQUE**

**SOLENOID FOR STARTERS**

**SOLENOIDE PER MOTORINI AVVIAMENTO**

**SOLENOIDE POUR DEMARREUR**

REF	OEM
REC89-825096T01	38410-94552
	38410-89J00
	38410-94550
	38410-94551
	31800-94400
	31800-94401

 DT40C-W G-X (1986-99)  
 DT55, DT65 J-X (1988-99)  
 DT75, DT85 J-Y (1988-00)  
 DF25, DF30 Y-K6 (200-06)  
 DT90, DT100L-Y (1990-00)  
 V6 H-Y (1987-00)  
 DT115, DT140G-Y (1986-00)

DT150, DT200, DT225W-K3 (1998-03)  
 DF40, DF50 X-K10 (1999-10)  
 DF115WT, DF140WT K3 (2003)  
 DF90, DF100, DF115 (2001-11)  
 DF60, DF70 W-K9 (1998-09)  
 DF140 (2002-11)



**new**

**LLAVES DE ARRANQUE**

**IGNITION STARTER SWITCH**

**CHIAVI DI ACCENSIONE**

**CONTACTEUR A CLÉ**

REF	OEM	2T STROKES	4T STROKES
REC37110-99E00	37110-99E00	✓	✓



**REGULADORES Y RECTIFICADORES**

**REGULATOR AND RECTIFIERS**

**REGOLATORI E RADDRIZZATORI**

**REGULATEURS ET RECTIFIEURS**

REF	OEM
REC32800-95D01	32800-95D01
	32800-95D00
	32800-95720

 DF9.9 / DF15 (1996-11)  
 DT4-DT140 (1986-04)  
 V6 H-Y (1987-00)



REF	OEM
REC32800-94620	32800-94620
	92800-94610

 DT115, DT140



**new**

REF	OEM
REC32800-94J11	32800-94J11
	32800-94J10

 DF9.9B, DF15A, DF20A



**new**

REF	OEM
REC32800-38F10	32800-38F10

 DF40, DF50X-K10



**new**

REF	OEM
REC32800-99J00	32800-99J00



new

REF	OEM
REC32800-88L00	32800-88L00



DF40A, DF50A, DF60A

new

REF	OEM
REC32800-89L01	32800-89L01 32800-89L00

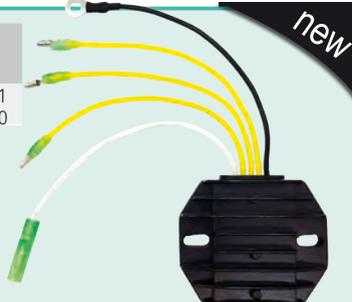

DF9.9B, DF15A, DF20A

new

REF	OEM
REC32800-87L00	32800-87L00



DF70A, DF80A, DF90A, DF100B

new

REF	OEM
REC32800-89J00	32800-89J00



DF25, DF30 Y-K6

new

REF	OEM
REC32800-87J10	32800-87J10



DF40, DF50X-K10

new

REF	OEM
REC32800-89J11	32800-89J10 32800-89J02 32800-89J11



DF25, DF30 Y-K6

new

REF	OEM
REC32800-92E20	32800-92E20

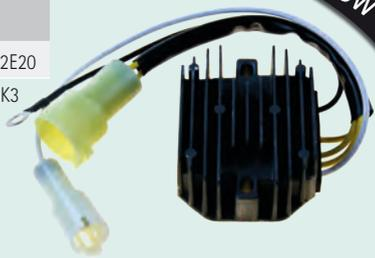

DT150, DT200, DT225 W-K3

new

REF	OEM
REC32800-93J03	32800-93J03 32800-93J02 32800-93J01



DF200, DF225, DF250

new

REF	OEM
REC32800-98J01	32800-98J01



DF250AP, DF300AP (2012+)  
DF300T/Z (2007-11)

new

GUÍA REGULADORES Y RECTIFICADORES

REGULATORS AND RECTIFIERS GUIDE

GUIDA REGOLATORE E RETTIFICATORE

GUIDE REGULATEURS ET RECTIFIEURS

	REF	
DF9.9B, DF15A, DF20A	REC32800-94J11	2013 +
DF9.9B, DF15A, DF20A	REC32800-89L01	2013 +
DF25, DF30 Y-K6	REC32800-89J00	2000-06
DF25, DF30 Y-K6	REC32800-89J11	2000-06
DF25A, DF30A	REC32800-88L00	2015-17
DF40, DF50X-K10	REC32800-38F10	1999-10
DF40, DF50X-K10	REC32800-87J10	1999-10
DF40A, DF50A, DF60A	REC32800-88L00	2010-17
DF60, DF70 W-K9	REC32800-92E20	1998-09

	REF	
DF70A, DF80A, DF90A, DF100B	REC32800-87L00	2009 +
DF200, DF225, DF250	REC32800-93J03	2004 +
DF250AP, DF300AP	REC32800-98J01	2012+
DF300T/Z	REC32800-98J01	2007-11
DT4, DT5	REC32800-95D01	1998-01
DT15, DT20, DT25, DT30, DT40	REC32800-95D01	1986-02
DT115, DT140	REC32800-95D01	1986-00
DT115, DT140	REC32800-94620	1986-00
DT150, DT200, DT225 W-K3	REC32800-92E20	1998-03

RELÉ

RELAY

RELE

RELAIS

RELÉ ECM

ECM RELAY

RELE ECM

RELAIS ECM

REF	OEM	VOLTAJE	STROKES
REC38860-76F01	38860-76F01	12V	4T ✓

DF8 --> DF350

CDI Y CAJAS NEGRAS

CDI & POWER PACK

CDI E CENTRALINA

CDI ET BOITIER ELECTRONIQUE

REF	OEM
REC32900-93910	32900-93911

DT9.9K, DT15K-G-Y (1986-00)

REF	OEM
REC32900-96371	32900-96371 32900-96350 32900-96370

DT20, DT25, DT30G-Y (1986-00)  
DT25, DT30K1-K2 (2001-02)

REF	OEM
REC32900-94460	32900-94460 32900-94470

DT40C-W-G-X (1986-99)  
DT40WK1-K4 (2001-04)

DESCONECTORES DE SEGURIDAD

CUT OFF SWITCHES

CHIAVETTA DI SICUREZZA

COUPE CIRCUIT DE SECURITE

REF	OEM
REC37800-93954	37800-93954 37800-93953

DT2, DT2.2G-Y (1986-00)  
DT20, DT25, DT30G-Y (1986-00)  
DT25, DT30K1-K2 (2001-02)  
DT40G-X-W-C (1986-99)  
DT9.9, DT15K1-K5 (2001-04)  
DT9.9K, DT15K-G-Y (1986-00)

REF	OEM
REC37820-92E03	37820-92E00

DT4, DT140HP  
DF9.9, DF140 HP  
V6H-Y

REF	OEM
REC37830-89E03	37830-95000 37830-89E02

DT15C (1989-97)  
DT9.9, DT15K1-K4 (1986-00)  
DT4, J4, DT5Y (1988-97)  
DT5Y (1998-02)  
DT5, DT6, DT8Y-G (1986-00)  
DT6, DT8Y-K2 (2000-02)  
DT8, DT9.9C-J-V (1988-97)  
DT9.9K, DT15K-G-Y (1986-00)  
DT75, DT85Y-J (1988-00)

KITS	KITS	KIT	KITS												
Interruptor de encendido para todo tipo de motores fueraborda o intraborda	Emergency and stop switch for inboard or outboards.	Interruttore di accensione per tutti i tipi di motori fuoribordo o entro bordo.	Coupe circuit de sécurité pour moteur inboard ou hors-bord												
<table border="1"> <tr> <th>REF KIT</th> <th>CUERDA WIRE CORDA CORDON</th> <th></th> </tr> <tr> <td>REC40970</td> <td>REC40990</td> <td>1</td> </tr> </table> 	REF KIT	CUERDA WIRE CORDA CORDON		REC40970	REC40990	1		<table border="1"> <tr> <th>REF KIT</th> <th>CUERDA WIRE CORDA CORDON</th> <th></th> </tr> <tr> <td>GS11290</td> <td>GS11291</td> <td>1</td> </tr> </table> 	REF KIT	CUERDA WIRE CORDA CORDON		GS11290	GS11291	1	
REF KIT	CUERDA WIRE CORDA CORDON														
REC40970	REC40990	1													
REF KIT	CUERDA WIRE CORDA CORDON														
GS11290	GS11291	1													
<table border="1"> <tr> <th>REF KIT</th> <th></th> </tr> <tr> <td>GS11292</td> <td>1</td> </tr> </table> 	REF KIT		GS11292	1		<table border="1"> <tr> <th>REF</th> <th></th> </tr> <tr> <td>GS11294</td> <td>1</td> </tr> </table> 	REF		GS11294	1					
REF KIT															
GS11292	1														
REF															
GS11294	1														

## TRIM, TILT & POWER TRIM

INSTALACIÓN ELÉCTRICA	WIRING HARNESS	INSTALLAZIONE ELETTRICA	INSTALLATION ELECTRIQUE		
KIT CONVERSIÓN Sustituye de 2 a 3 cables.	CONVERSION KIT Converts 3-wire Tilt and Trim motors to 2-Wire design	KIT CONVERSIONE Sustituisce da 2 a 3 cavi.	KIT DE CONVERSION. Passe un faisceau de 2 à 3 fils.		
<table border="1"> <tr> <th>REF</th> </tr> <tr> <td>PH200-WH01</td> </tr> </table> 	REF	PH200-WH01			
REF					
PH200-WH01					

TRIM COMPLETO	COMPLETE TRIM ASSEMBLY	MOTORINO TRIM COMPLETO	MOTEUR DE TRIM														
Motor de Trim para modelos antiguos. Motor de 3 cables, para 2 cables instalar PH200-WH01.	Trim for old models. Trim with 3 wires, for convert to 3 wires, it needs PH200-WH01.	Trim per modelli vecchio. Trim con 3 cavi, per 2 cavi installare PH200-WH01	Pompe de Trim ancien modèle, avec faisceau 3 fils, pour les faisceaux à 2 fils il faut installer le kit PH200-WH01.														
<table border="1"> <tr> <th>REF</th> <th>OEM</th> <th>⚡</th> <th>⚡</th> <th>⚡</th> <th>2T STROKES</th> <th>4T STROKES</th> </tr> <tr> <td>PH200-T027</td> <td>48500-95550-OED 48500-95680-OED</td> <td></td> <td></td> <td>✓</td> <td></td> <td></td> </tr> </table> 	REF	OEM	⚡	⚡	⚡	2T STROKES	4T STROKES	PH200-T027	48500-95550-OED 48500-95680-OED			✓					<p><b>new</b></p>
REF	OEM	⚡	⚡	⚡	2T STROKES	4T STROKES											
PH200-T027	48500-95550-OED 48500-95680-OED			✓													

REF	OEM	⚡	⚡	⚡	2T STROKES	4T STROKES
REC38100-87E10-OED	38100-87D00 38100-87D0IT 38100-87D02H 38100-87E10-OED 38100-87D01-OED 38100-87D01-02M	12V	3	3	✓	
	DT90, DT100L-Y (1990-00)					
						
REF	OEM	⚡	⚡	⚡	2T STROKES	4T STROKES
REC38100-96J00	38100-92J02 38100-92J10 38100-92J01 38100-93J02 38100-96J00 38100-96J01 38100-92J12	12V	4	2		✓
	DF90, DF100, DF115K1-K11 (2001-11) DF200, DF225, DF250 (2004-11) DF300T/Z (2007-2011) DF150T/Z (2006-12)					
						

REF	OEM	⚡	🔩	🔗	2T STROKES	4T STROKES
REC38100-87J00	37100-87J00-OEP 38100-87JOEP	12V	4	2		✓

DF40, DF50X-K10 (1999-10)  
TMY99-00



REF	OEM	⚡	🔩	🔗	2T STROKES	4T STROKES
PH200-T024	38100-87D10-0ED 38100-87D10-35J 38100-87D10-0IT 38100-92E00-0ED 38100-87E20-0ED	12V	3	2		✓

DT150, DT200, DT225W-K3 (1998-03)  
V6H-Y (1987-00)



REF	OEM	⚡	🔩	🔗	2T STROKES	4T STROKES
PH200-T046	38100-87J11 38100-87J20	12V	4	2		✓

DF40, DF50X-K10 (1999-10)



REF	OEM	⚡	🔩	🔗	2T STROKES	4T STROKES
REC36120-ZW4-H12	38100-88L12 38100-88L11 38100-88L00	12V	4			✓

DF40A, DF50A, DF60A (2010+)



REF	OEM	⚡	🔩	🔗	2T STROKES	4T STROKES
REC36120-ZY9-003	38100-87L03 38100-87L02 38100-87L01 38100-87L00	12V	4			

DF70A, DF80A, DF90A (2009-16)



REF	OEM	⚡	🔩	🔗	2T STROKES	4T STROKES
REC36120-ZY6-013	38100-90J40 38100-90J30 38100-93J13 38100-93J11	12V	4			✓

DF60, DF70 W-K9 (1998-09)



REF	OEM	⚡	🔩	🔗	2T STROKES	4T STROKES
REC38100-99E01-0EP	38100-99E01-0EP 38100-99E01-00 38100-99E01-0ED	12V	2	2	✓	✓

DF60, DF70W-K9 (1998-09)  
DT55, DT65J-X (1988-99)  
DT75, DT85J-Y (1988-00)



REF	OEM	⚡	🔩	🔗	2T STROKES	4T STROKES
REC38100-97E00-0ED	38100-97E00-0ED	12V	4	2		✓

DT40C-W G-X (1986-99)



**POWER TRIM COMPLETO COMPLETE POWER TRIM ASSEMBLY**

REF	OEM	2T STROKES	4T STROKES
REC18-6865	48600-94511-0ED	✓	✓

3 RAM  
115-225HP  
SHOWA SYSTEM



**MOTORINO POWER TRIM COMPLETO POWER TRIM COMPLET**

REF	OEM	2T STROKES	4T STROKES
REC48503-93J12	48503-93J10 48503-93J12 48503-94900-0ED	✓	✓

DT115, DT140G-Y (1986-00)  
DF90 --> DF250  
Complete 3-Ram T/T System  
SHOWA SYSTEM

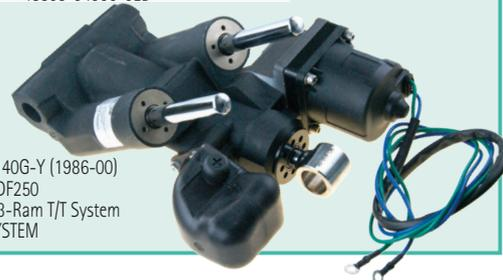



SENSORES DE TRIM      TRIM SENSORS      SENSORI TRIM      EMETTEUR DE TRIM

REF	OEM
REC34801-93J03	34801-93J03
	34801-93J02
	34801-93J01
	34801-93J00
 DF200, DF225, DF250 (2004+)	



REF	OEM
REC34801-94710	34801-94710
	34801-94700
 DF25, DF30 Y-K6 (2000-06)	
	DF40, DF50 X-K10 (1999-10)
	DF60, DF70 W-K9 (1998-09)
	DT55, DT65 J-X (1988-99)
	DT75, DT85 J-Y (1988-00)



REF	OEM
REC34801-99E04	34801-99E04
	34801-99E03
	34801-99E02
	34801-99E01
 DF25, DF30 (A) (2000+)	
	DF40, DF50 X-K10 (2001-11)
	DF60, DF70 W-K9 (1998-09)
	DF90, DF100, DF115 (2001-11)
	DF115WT, DF115WT-K3 (2003)
	DF140 (2002-12)
	DF150, DF175 (G/T/Z) (2006+)
	DF200, DF225, DF250 (2004+)



REF
STA84154
STA84104

TAPONES DE TRIM      TRIM CAP      TAPPO TRIM      BOUCHON VERIN DE TRIM

REF	OEM
REC48630-96J03	48630-96J03
	48630-96J02
	48630-96J01
 DF100A, DF115A, DF140A (2013-16)	
	DF140 (2000-12) (14002F/14002Z)
	DF150T/Z, DF175T/Z (G) (2006-16)
	DF150T (881864+)
	DF150AP, DF175AP, DF200AP (2017+)
	DF200, DF225, DF250 (2004-16)
	DF200A/AP (2015-16)



REF	OEM
REC48630-94900	48630-94900
 DF60, DF70W-K9 (1998-09)	
	DT115, DT140 G-Y (1986-00)



REF	OEM
REC48630-92J00	48630-92J00
 DF140WT, DF140WT (2003)	
	DF140 (2002-11)
	DF115WT, SF115WT K3 (2003)



REF	OEM
REC48630-96J00	48630-96J00
 DF150, DF175 T/Z (2006-11)	



REF	OEM
REC48630-93J00	48630-93J00
 DF200, DF225, DF250 (2004-11)	

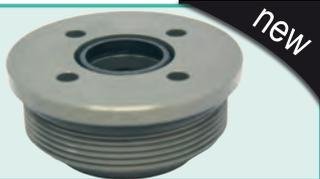

REF	OEM
REC48630-98L01	48630-98L01
	48630-98L00
 DF250AP, DF300AP (2012-18)	
	(25003P/30002P)
	DF200, DF225, DF250 (2004+)
	DF300T/Z (2007-11)
	DF350A, DF325A (2018+)
	DF300B (2020)



EXTRACTOR TAPONES TRIM      TRIM PLUGS EXTRACTOR      ESTRATTORE PER TAPPI DI TRIM      KIT EXTRACTEUR DE BOUCHONS TRIM

REF	
RECTOOLTRIMKIT	RECTOOLTRIM1 + RECTOOLTRIM2 + RECTOOLTRIM3



TRIM PISTON	TILT PISTON	
RECTOOLTRIM2	RECTOOLTRIM3	DF115 - DF300

REF		A
RECTOOLTRIM1	1/2" + RECPIN4	38 mm
RECTOOLTRIM2	1/2" + RECPIN4	32 mm
RECTOOLTRIM3	1/2" + RECPIN6	35 mm

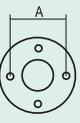

REF	
RECPIN4	3 PIN x 4 mm
RECPIN4.5	3 PIN x 4.5 mm
RECPIN6	3 PIN x 6 mm



Los pines de repuesto no tienen garantía.  
Replacement pins are not guaranteed.  
I pini di ricambio non sono garantiti.  
Les pins de remplacement ne sont pas garanties

# SISTEMA DE GOBIERNO STEERING SYSTEM

# SISTEMA DI GUIDA SYSTÈME DE COMMANDE

## MANDOS DE CONTROL

## ENGINE CONTROLS

## COMANDI DI CONTROLLO

## BOITIER DE COMMANDE

### MANDO LATERAL

### SIDE CONTROL

### COMANDO LATERALE

### BOITIER LATERAL

REF	OEM	POWER TRIM
REC67200-94J20	67200-94J20	
	67200-91J00	
	67200-91J01	
	67200-91J04	

- DF8A, DF9.9A (2010+)
- DF9.9, DF15 (2005-10)
- DF25, DF30 (2005-08)
- DF25A, DF30A (2014+)
- DF25V-TWIN (2006+)

REF	RO OEM	POWER TRIM
REC67200-99E56	67200-99E56	
	67200-99E10-OEP	
	67200-99E30-OEP	✓
	67200-99E50	
	67200-99E51	

- DF25, DF30 (W+W/O PT) (2000-04)
- DF40, DF50 (1999-04)
- DF60, DF70 (1998-04)

REF	RO OEM	POWER TRIM
REC67200-93J51	67200-93J51	
	67200-93J50	
	67200-93J06	
	67200-93J04	
	67200-93J03	✓
	67200-93J02	
	67200-93J01	
	67200-93J00	

- DF25A, DF30A (2014+)
- DF40, DF50 (2005-10)
- DF40A, DF50A, DF50AV, DF60A, DF60AV (2010+)
- DF60Q, DF70 (2005-10)
- DF70A, DF90A (2010+)
- DF90, DF115, DF140 (2005+)
- DF150, DF175, DF200A (2006+)
- DF200, DF225, DF250 (2005+)



REC67200-94J20



REC67200-99E56  
REC67200-93J51

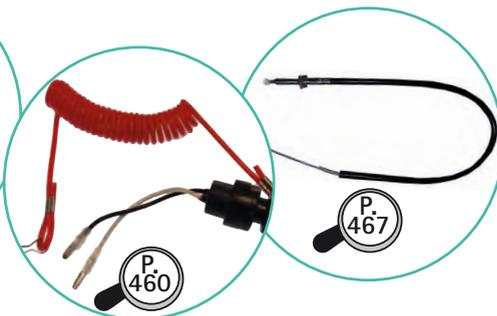

new

RECMAR®

MANDO PARA CONSOLA

CONSOLE CONTROL

COMANDO PER  
CONSOLLA

BOITIER POUR CONSOLE

SUZUKI (BINACLE)

REF	RO OEM	POWER TRIM
REC67200-88L00	67200-88L00 67200-93J12 67200-93J13	✓

**RECMAR**



REF	RO OEM	POWER TRIM
REC67200-88L10	67200-88L10 67200-93J15	✓



new

INTERRUPTORES  
PARA MANDOS

SWITCHES FOR  
ENGINE CONTROLS

INTERRUTTORI PER  
CONTROLLO

INTERRUPTEUR DE  
CONTRÔLE

INTERRUPTOR PANEL  
SIMPLE

SWITCH

INTERRUTTORE PANNELLO  
SINGOLO

TABLEAU DE DEMARRAGE  
SIMPLE

REF	OEM
REC37100-96J25	37100-96J20
	37100-96J21
	37100-96J22
	37100-96J23
	37100-96J24 37100-96J25

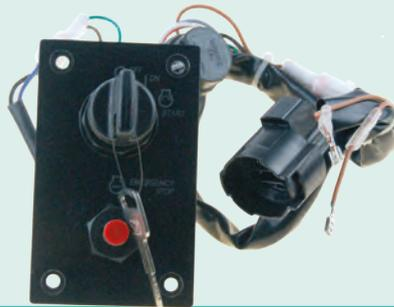

new

INTERRUPTOR PANEL  
COMPLETO O DOBLE  
ESTACION

PANEL TWIN STATION

PANNELLO DOPPIA  
STAZIONE

TABLEAU DE DEMARRAGE  
POUR 2 MOTEURS

REF	OEM
REC37100-96J15	37100-96J14 37100-96J15

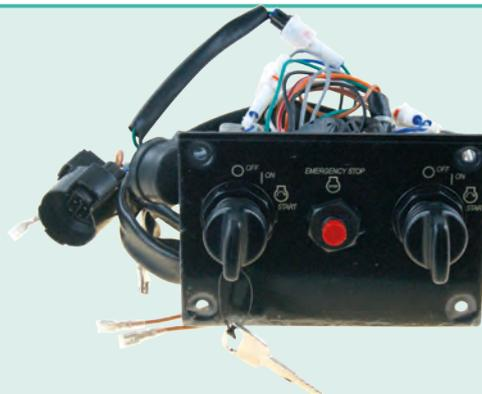

new

SUZUKI

RECAMBIOS  
MARINOS

## ARNÉS

## ARNES

## CAVI

## FAISCEAU ELECTRIQUE

### EXTENSIÓN DE ARNÉS SISTEMAS ANALÓGICOS

### ARNES EXTENSION ANALOGIC SYSTEM

### ESTENSIONE SISTEMA ANALOGICO

### RALLONGE FAISCEAU SYSTEME ANALOGIQUE

REF	OEM		POWER TRIM
REC36620-93J02	36620-93J02	5 m	✓
REC36620-94J01	36620-94J01	5 m	



REC36620-93J02



REC36620-94J01

new

## COMPONENTES

## COMPONENTS

## COMPONENTI

## COMPOSANT

### CONECTORES DE CABLES

### CABLE CONNECTOR

### CAVO CONNETTORE

### EMBOUT DE CABLE

REF	OEM
PAF25-07000007W	67275-95600



### CLIP

### CLIP

### CLIP

### CLIP

REF	OEM
PAGB/T896-6	57292-94300



### PLACA CERRADURA SELECTOR

### BLOCK CONTROL HANDLE

### PLACCA SERRATURA SELETORE

### CALE POIGNEE DE CONTROLÉ

REF	OEM
PAF15-13010010W	67256-95600



### CASQUILLO BASCULANTE

### BUSH, SWIVEL

### TAPPO GIREVOLE

### BAGUE

REF	OEM
REC43211-87JLO	43211-87JLO 43211-94401

 DF8 (2010+)  
 DF9.9 (2004+)  
 DF15 (2004+)  
 DF20 (2011+)



REF	OEM
REC43211-94401	43211-94401

 DF15 (1989-97)  
 DT35 (1986-89)  
 DT40 (1986-98)  
 DF9.9 (2006-10)  
 DF15 (2004-10)  
 DF25 (2000-07)  
 DF30 (2000-07)  
 DF40 (1999-10)  
 DF50 (1999-10)



REF	OEM
REC43711-97E11	43711-97E00 43711-97E11

 DT40 --> DT225 HP  
 DF40 --> DF300 HP



**CABLE DE ACELERADOR**

**THROTTLE CABLE**

**CAVO ACCELERATORE**

**CÂBLE D'ACCELERATEUR**

REF	OEM		
REC63610-89E01	63610-89E01-000		DT15C (1989-97)
REC63610-93501	63610-93501-000		DT9.9 - 16 (1982-92)
REC63610-96302	63610-96302-000	490 mm	D20, DT25, DTG-Y (1986-00)
REC63610-96321-000	63610-96321-000	560 mm	DT9.9K, DT15K-G-Y (1986-00) DT9.9, DT15K1-K4 (2001-04)
REC63610-94402	63610-94402-000		DT40C-W-G-X (1986-99) DT40W-K1-K4 (2001-04)
REC63610-91J20	63610-91J20		DF4, DF5, DF6 (2002-15)
	63610-91J00		
	63610-91J01		
	63610-91J03		
	63610-91J04		



**new**

**CABLES DE CONTROL**

**CONTROL CABLES**

**CAVI COMANDO**

**CÂBLES DE COMMANDE**

Recorrido trabajo: 76 mm.  
Rosca 10-32"

Travel 3"  
Threaded 10-32"

Estensione 76 mm  
Filetto 10-32"

Course: 76 mm.  
Fil 10-32

maxflex



REF	RO	
PRE3300C08	99105-11002-008	8' / 2,45 m
PRE3300C09	99105-11002-009	9' / 2,75 m
PRE3300C10	99105-11002-010	10' / 3,05 m
PRE3300C11	99105-11002-011	11' / 3,35 m
PRE3300C12	99105-11002-012	12' / 3,65 m
PRE3300C13	99105-11002-013	13' / 3,95 m
PRE3300C14	99105-11002-014	14' / 4,25 m
PRE3300C15	99105-11002-015	15' / 4,60 m
PRE3300C16	99105-11002-016	16' / 4,90 m
PRE3300C17	99105-11002-017	17' / 5,20 m
PRE3300C18	99105-11002-018	18' / 5,50 m
PRE3300C19	99105-11002-019	19' / 5,80 m
PRE3300C20	99105-11002-020	20' / 6,10 m
PRE3300C21	99105-11002-021	21' / 6,40 m
PRE3300C22	99105-11002-022	22' / 6,70 m
PRE3300C23	99105-11002-023	23' / 7,00 m
PRE3300C24	99105-11002-024	24' / 7,30 m
PRE3300C25	99105-11002-025	25' / 7,60 m
PRE3300C26	99105-11002-026	26' / 7,90 m
PRE3300C27	99105-11002-027	27' / 8,25 m
PRE3300C28	99105-11002-028	28' / 8,55 m
PRE3300C29	99105-11002-029	29' / 8,85 m
PRE3300C30	99105-11002-030	30' / 9,15 m

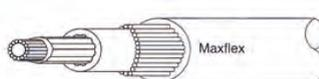

**DIRECCIÓN HIDRÁULICA**

**HYDRAULIC STEERING**

**TIMONERIA IDRAULICA**

**DIRECTION HYDRAULIQUE**

Bomba de aluminio, con válvula anti-retorno incorporada. Cilindro de aluminio y acero inoxidable, con purgadores. Se suministra completa con racors, tubo flexible de rilsan y 2L de aceite hidráulico

Helm pump made in aluminum, with non-return valve incorporated. Cylinder in aluminum and stainless steel, with breather valves. Completed with racors, rilsan tubing and 2L hydraulic oil.

Corpo pompa in alluminio, con valvola anti-retorno incorporata. Cilindro in alluminio e acciaio inox, con spurgo. Si vende completa di raccordi, tubo flessibile e 2 l di olio idraulico.

Corps de pompe en aluminium, avec clapet anti-retour intégré. Vérin en aluminium et acier inox, avec purge. Kit vendu complet avec raccords, flexible et 2L d'huile hydraulique.

				TX4200K 150 HP	TX6400K 300 HP
Modelo bomba	Pump model	Modello pompa	Modèle pompe	BayStar	SeaStar
Capacidad bomba	helm volume	Cap. Pompa	Capacité	23 cm <sup>3</sup>	27,8 cm <sup>3</sup>
Modelo cilindro	Cylinder model	Mod. Cilindro	Mod. vérin	HC4645H	HC5345H
Capacidad cilindro	Cylinder volume	Cap. Cilindro	Capacité	105 cm <sup>3</sup>	139 cm <sup>3</sup>
Carrera del pistón	Cylinder travel	Corsa pistone	Course	206 mm	206 mm
Nº vueltas babor-estribor	Turns lock to lock	Nº giri a destra e sinistra	Nombre de tours	5	5
Manguera con racors	Hose with racors	Tubo con raccordo	Tuyaux avec raccords	2 x 6 m	2 x 7 m
Velocidad máxima	Max. speed	Velocità max	Vitesse max	50 kn	65 kn



**SUZUKI**

**RECAMBIOS MARINOS**

# SISTEMA DE REFRIGERACIÓN COOLING SYSTEM

# SISTEMA DI RAFFREDDAMENTO SYSTÈME DE REFROIDISSEMENT

## TERMOSTATO

## THERMOSTAT

## TERMOSTATO

## THERMOSTAT

### TERMOSTATO

### THERMOSTAT

### TERMOSTATO

### THERMOSTAT

REF	OEM	°C
REC67F-12411-01	17670-93J00	60°

 DF70A, DF80A, DF90A (2009+)  
 DF100B (2018+)  
 DF90, DF100, DF115 (2001-11)  
 DF140 (2002-12)  
 DF115WT, DF140WTK-3 (2003)  
 DF150T/Z, DF175T/Z (2006-11)  
 DF200, DF225, DF250 (2004+)  
 DF300T/Z (2007-11)



REF	OEM	°C
REC17670-91J01	17670-91J01 17670-91J00	50°

 DF2.5 (2006)  
 DF4, DF5, DF6 (2002+)  
 DF9.9B, DF15A, DF20A (2013+)



REF	OEM	°C
REC17670-87J00	17670-87J00	72°

 DF40, DF50X-K10 (1999-10)  
 DF60, DF70W-K9 (1998-09)



REF	OEM	°C
REC17670-93962	17670-93962	50°

 DF40, DF50X-K10 (1999-10)  
 DF60, DF70W-K9 (1998-09)  
 DT20, DT25, DT30G-Y (198600)  
 DT25, DT30 K1-K2 (2001-02)  
 DT40C-W G-X (1986-99)  
 DT40WK1-K4 (2001-04)  
 DT55, DT65J-X (1988-99)  
 DT9.9, DT15K1-K4 (2001-04)  
 DT9.9K, DT15K G-Y (1986-00)



REF	OEM	°C
REC17670-90J10	1770-90J10	71°

 DF100A, DF115A, DF140A (2013+)  
 DF140 (2002-12)  
 DF150, DF175 (2006+)  
 DF200, DF250, DF225 (2004+)  
 DF300 (2019+)  
 DF70, DF80, DF90 (A) (2009+)  
 DF100B (2018+)  
 DF90, DF100, DF115 (2001-11)



REF	OEM	°C
REC17670-94402	17670-94402	60°

 DF25, DF30Y-K6 (2000-06)  
 DF640, DF50X-K10 (1999-10)  
 DF60, DF70W-K9 (1998-09)  
 DF9.9, DF15 (1996-11)  
 DT20, DT25, DT30G-Y (1986-00)  
 DT25, DT30K1-K2 (2001-02)  
 DT40C-W G-X (1986-99)  
 DT40W K1-K4 (2001-04)  
 DT9.9, DT15 (1986-04)



REF	OEM	°C
REC17670-90J20	17670-90J20	50°

 DF100, DF115, DF140 (2013+)  
 DF150, DF175, DF200 (2018+)  
 DF150, DF175 (2012+)  
 DF200A/AP/AT (2015+)  
 DF250AP, DF300AP (2012+)



REF	OEM	°C
REC17670-94J01	17670-94J01 17670-94J00	60°

 DF8A, DF9.9A (AR) (2010+)  
 DF9.9, DF15 (R) (2004-12)  
 DF20R, DF25R/Q, V2 (2006-13)  
 DF25A, DF30A (2015+)



TAPÓN DE AGUA

WATER FLUSH PLUG

TAPPO ACQUA

BOUCHON DE REFROIDISSEMENT

REF	OEM
REC17913-93J00	17913-93J00



REF	OEM
REC17914-93J00	17914-93J00 17914-93JLO



new

IMPULSORES

IMPELLERS

GIRANTE

TURBINES

GUÍA DE IMPULSORES

IMPELLER GUIDE

GUIDA GIRANTE

GUIDE TURBINES

2T  
STROKES

		REF	OEM	CEF	A (mm)	B (mm)	C (mm)
DT4	1988-01	REC17461-98503	17461-98501,2,3	CEF500336	10,15	41	14
DT5	1986-02	REC17461-98503	17461-98501,2,3	CEF500336	10,15	41	14
DT6	1984-02	REC17461-98503	17461-98501,2,3	CEF500336	10,15	41	14
DT8	1980-87	REC17461-98503	17461-98501,2,3	CEF500336	10,15	41	14
DT8	1988-97	REC17461-92D02	17461-92D02	CEF500319	12,2	42	20
DT9,9	1980-87	REC17461-93004	17461-93001,3,4	CEF500398	15	70	12,5
DT9,9	1988-97	REC17461-92D02	17461-92D02	CEF500319	12,2	42	20
DT14	1977-80	REC17461-93004	17461-93001,3,4	CEF500398	15	70	12,5
DT15	1986-97	REC17461-93903	17461-93901,2,3	CEF500329	13,2	42	22
DT16	1977-82	REC17461-93004	17461-93001,2,3,4	CEF500398	15	70	12,5
DT20	1986-88	REC17461-96312	17461-96301	CEF500362G	17,1	67,5	16,18
DT25	1977-82	REC17461-93004	17461-93001,2,3,4	CEF500398	15	70	12,5
DT25	1983-88	REC17461-96312	17461-96301	CEF500362G	17,1	67,5	16,18
DT25	1989-00		17461-96400	CEF500399	17,2	67	16,16
DT28	1972-82	REC17461-93004	17461-93002	CEF500398	15	70	12,5
DT30	1983-85	REC17461-96312	17461-96301	CEF500362G	17,1	67,5	16,18
DT30	1989-00		17461-96400	CEF500399	17,2	67	16,16
DT35	1987-89	REC17461-96312	17461-96301	CEF500362G	17,1	67,5	16,18
DT40	1983	REC17461-94700	17461-95201	CEF500312	19,13	51,8	19
DT40	1984-98	REC17461-96312	17461-96310	CEF500362G	17,1	67,5	16,18
DT50	1978-84	REC17461-95300	17461-95501,95300	CEF500360	20,1	67,5	19
DT55	1985-97	REC17461-94700	17461-94700,1	CEF500361	17,1	67	19
DT60	1983	REC17461-94700	17461-95200	CEF500361	17,1	67	19
DT60	1984	REC17461-96312	17451-96301	CEF500362G	17,1	67,5	16,18
DT65	1985-97	REC17461-94700	17461-94701	CEF500361	17,1	67	19
DT75	1983-97	REC17461-95300	17461-95501,95300,1,2	CEF500360	20,1	67,5	19
DT85	1983-00	REC17461-95300	17461-95501,95300,1,2	CEF500360	20,1	67,5	19
DT90	1988+	REC17461-87E12	17461-87E12	CEF500365	22,2	78,3	35,1
DT100	1988+	REC17461-87E12	17461-87E12	CEF500365	22,2	78,3	35,1
DT115	1986-01	REC17461-90J01	17461-94510	CEF500367	24,3	86	31,7
DT140	1986-01	REC17461-90J01	17461-94510	CEF500367	24,3	86	31,7
DT150	1987-96	REC17461-90J01	17461-90J01	CEF500367	24,3	86	31,7
DT200	1998-03	REC17461-90J01	17461-90J00	CEF500367	24,3	86	31,7
DT225	1998-2003	REC17461-90J01	17461-90J00	CEF500367	24,3	86	31,7

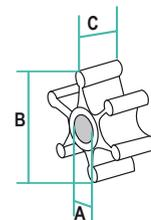

REC17461-98503



REC17461-92D02



REC17461-93004



REC17461-93903



REC17461-96312



REC17461-94700



REC17461-95300



REC17461-87E12



REC17461-90J01

SUZUKI

RECAMBIOS MARINOS

		REF	OEM	CEF	A (mm)	B (mm)	C (mm)
DF2.5	2003+	REC17461-97JM0	17461-97110				
DF4	2003+	REC17461-98503	17461-98503	CEF500336	10,15	41	14
DF6	2003+	REC17461-98503	17461-98503	CEF500336	10,15	41	14
DF8	2010+	REC17461-93903	17461-93903	CEF500329	13,2	42	22
DF9,9	2004+	REC17461-93903	17461-93903	CEF500329	13,2	42	22
DF15	2004+	REC17461-93903	17461-93903	CEF500329	13,2	42	22
DF25	1999-10	REC17461-96312	17461-96312	CEF500362G	17,1	67,5	16,18
DF25A	2015+	REC17461-96312	17461-94L00				
DF30	1999-07	REC17461-96312	17461-96312	CEF500362G	17,1	67,5	16,18
DF30A	2015+	REC17461-96312	17461-94L00				
DF40	1999+	REC17461-96312	17461-96312	CEF500362G	17,1	67,5	16,18
DF50	1999+	REC17461-96312	17461-96312	CEF500362G	17,1	67,5	16,18
DF60	1998-09	REC17461-87E12	17461-87E10,11,12	CEF500365	22,2	78,3	26
DF70	1998+	REC17461-87E12	17461-87E10,11,12	CEF500365	22,2	78,3	26
DF80	2010+	REC17461-87E12	17461-87E10,11,12	CEF500365	22,2	78,3	26
DF90	2010+	REC17461-87E12	17461-87E10,11,12	CEF500365	22,2	78,3	26
DF100	2001+	REC17461-90J01	17461-90J01	CEF500367	24,3	86	31,7
DF115	2002+	REC17461-90J01	17461-90J01	CEF500367	24,3	86	31,7
DF140	2002+	REC17461-90J01	17461-90J01	CEF500367	24,3	86	31,7
DF150	2008+	REC17461-90J01	17461-90J01	CEF500367	24,3	86	31,7
DF175	2007+	REC17461-90J01	17461-90J01	CEF500367	24,3	86	31,7
DF200	2004+	REC17461-93J00	17461-93J00	CEF500393	24,3	87	39
DF225	2004+	REC17461-93J00	17461-93J00	CEF500393	24,3	87	39
DF250	2004+	REC17461-93J00	17461-93J00	CEF500393	24,3	87	39
DF300	2007+	REC17461-93J00	17461-93J00	CEF500393	24,3	87	39

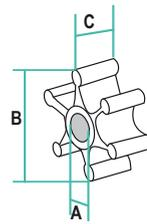

REC17461-97JM0



REC17461-98503



REC17461-96312



REC17461-87E12



REC17461-90J01



REC17461-93J00

CHAVETA

KEY

CHIAVETTA

CLAVETTE

REF	OEM	
REC09420-03005	09420-03005 09420-03009	REC17461-93903



DF15 (2012)  
DF8Z, DF9.9A (AR) (2010+)  
DF9.9, DF15 (R) (2004-11)  
DF9.9B, DF15A, DF20A (2013+)

REF	OEM	
REC17462-93990	17462-93990	



DT9.9 (1983-87)  
DT15 (1983-97)  
DF9.9 (2004-10)  
DF15 (2004-10)

REF	OEM	
REC09420-03002	09420-03002	REC17461-98503



DF4, DF5, DF6 (2006+)  
DT4/J4, DT5Y (1988-00)  
DT4K1 (2001)  
DT5, DT6, DT8G-Y (1986-00)  
DT5Y (1998-02)  
DT6, DT8Y-K2 (2000-02)

REF	OEM	
REC09420-05009	09420-05009 09420-05006	



DF115WT, DF140WT K3 (2003)  
DT115, DT140G-Y (1986-00)  
DT150, DT200, DT225W-K3 (1989-03)  
V6H-Y (1987-00)  
DF100A, DF115, DF140A (2013+)  
DF140 (2002-12)  
DF150, DF175 (2006+)  
DF200, DF225, DF250 (2004+)  
DF250AP, DF300AP (2013+)  
DF350, DF300 (2007)  
DF90, DF100, DF115 (2001-11)

REF	OEM	
REC09420-04006	09420-04006	REC17461-96312



DF20R, DF25 (RVZ) (2006-11)  
DF25/R/QVZ (2013)  
DF25, DF30Y-K6 (2000-06)  
DF40, DF50X-K10 (1999-10)  
DF40A, DF50A, DF60A (2010+)  
DT20, DT25, DT30G-Y (1986-00)  
DT25, DT30 K1-K2 (2001-02)  
DT25C, DT30C K-Y (1989-00)  
DT40C-W G-X (1986-99)  
DT40W K1-K4 (2001-04)



TAPA DEL IMPULSOR

IMPELLER PLATE

COPERCHIO GIRANTE

PLAQUE DE POMPE À EAU

REF	OEM
REC17471-92J02	17471-93J02 17471-93J01 17471-93J00



**new**

 DF150, DF175 (T/Z) (2006+)  
 DF200, DF225, DF250 (2004+)  
 DF150AP, DF175AP, DF200AP (2017+)  
 DF150AT, DF175AT, DF200AT (2019)  
 DF200A/AP (2015-17)  
 DF200AT/AZ (2018)

REF	OEM
REC17471-92J00	17471-92J00 17471-87E00 17471-87E01



**new**

 DT90, DT100L-Y (1990-00)  
 DF60, DF70W-K9 (1998-09)  
 DF90, DF100, DF115 (2001-11)  
 DF140 (2002-12)  
 DF100A, DF115A, DF140A (2013+)

REF	OEM
REC17471-95J01	17471-95J01 17471-95J00



**new**

 DF20R, DF25, DF25R/Q (V2) (2006-13)  
 DF40A, DF50A, DF60A (2010+)

REF	OEM
REC17471-97J00	17471-97J00-00



**new**

 DF2.5 (2006-11)

REF	OEM
REC17471-98601	17471-98601 17471-98600



**new**

 DT4-J4-DT5Y (1988-00)  
 DT4K1 (2001)  
 DT5Y (1998-02)

REF	OEM
REC17471-97JL0	17471-97JL0



**new**

 DT2.5 (2012+)

REF	OEM
REC17471-94401	17471-94401



 DF25, DF30Y-K6 (2000-06)  
 DF40, DF50X-K10 (1999-10)  
 DF20, DF25, DF30G-Y (1986-00)  
 DF25C, DT30C-K-Y (1989-00)  
 DT40C-W-G-X (1986-99)  
 DT25, DT30 K1-K2 (2001-02)  
 DT40W - K1-K4 (2001-04)

REF	OEM
REC17471-93902	17471-93902



 DF9.9(R)T-K3 (1996-11)  
 DF15(R)-K3 (1996-12)  
 DT15C (1989-97)  
 DT9.9, DT15K1-K4 (2001-04)  
 DT9.9K, DT15K-G-K4 (2001-04)  
 DT9.9K, DT15K-G-Y (1986-00)

BOMBA DE AGUA

WATER PUMP

POMPA ACQUA

POMPE À EAU

CUERPO BOMBA DE AGUA

HOUSING, WATER PUMP

CORPO, POMPA ACQUA

CORPS DE POMPE À EAU

REF	OEM
REC17411-93901	17411-93901 17410-93910



 DT9.9, DT15 K1-K4 (2001-04)  
 DT9.9K, DT15K-G-Y (1986-00)  
 DT15C (1989-97)  
 DF9.9, DF15 (R) (2004-11)  
 DF9.9, DF15T-K3 (1996-03)

REF	OEM
REC17450-93921	17450-93921 17450-93920 17450-93930 17450-93440



**new**

 DT9.9K, DT15K G-Y (1986-00)

REF	OEM
REC17411-94421	17411-94421 17410-94431



 DF40, DF50X-K10 (1999-10)  
 DT20, DT25, DT30G-Y (1986-00)  
 DT25, DT30 K1-K2 (2001-02)  
 DT40C-W-G-X (1986-99)  
 DT40W K1-K4 (2001-04)  
 DF25, FG30Y-K6 (2000-06)

TAPA DE LA BOMBA

WATER PUMP, COVER

COPERCHIO POMPA

PLAQUE DE POMPE À EAU

REF	OEM
REC56130-94413-0EP	56130-94413-0EP 56130-94411-0EP

 DF40, DF50X-K10 (1999-10)  
 DF40W-K1-K4 (2001-04)



REF	OEM
REC56130-96331-0EP	56130-96331-0EP 56130-96320-0EP

 DT25, DT30



new

JUNTA BASE DE BOMBA

WATER PUMP, GASKET BASE

GUARNIZIONE BASE POMPA

JOINT, BASE DE POMPE À EAU

REF	OEM
REC17472-98J00	17472-98J00

 DF250AP, DF300AP (2012+)  
 DF300T/Z (2007-11)



REF	OEM
REC17472-97JL0	17472-97JL0

 DF2.5 (2012+)



new

REF	OEM
REC17472-97J00	17472-97J00

 DF2.5 (2006-11)



new

REF	OEM
REC17472-87L00	17472-87L00

 DF70A, DF80A, DF90A (2009+)  
 DF100B (2018+)



new

REF	OEM
REC17472-96303	17472-96301 17472-96302 17472-96303



 DT20, DT25, DT30 (1986-04)  
 DF25, DF30 (2000-06)  
 DF20R, DF25R (VZ) (2006-13)  
 DF40, DF50 (1999-10)  
 DF40A, DF50A, DF60A (2010+)



new

REF	OEM
REC17472-87E10	17472-87E10 17472-87E00

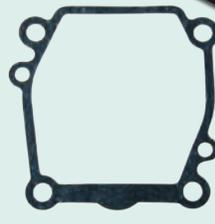
 DF100A, DF115A, DF140A (2013+)  
 DF115WT, DF140WT K3 (2003)  
 DF140 (2002-12)  
 DF60, DF70 W-K9 (1998-09)  
 DF90, DF100, DF115 (2001-11)  
 DF40A, DF50A, DF60A (2014+)  
 DT90, DT100L-Y (1990-00)



new

JUNTA TÓRICA BOMBA DE AGUA

WATER PUMP, O-RING

GUARNIZIONE

JOINT TORIQUE DE POMPE À EAU

REF	OEM
REC17417-92J00	17417-92J00



 DF140 (2002-11)  
 DF90, DF100, DF115 (2001-11)



new

REF	OEM
REC17416-92J10	17416-92J10

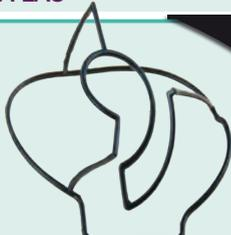
 DF100A, DF115A, DF140A (2013+)  
 DF140 (2002-12)  
 DF90, DF100, DF115 (2001-11)



new

REF	OEM
REC17416-93J00	17416-93J00



 DF200, DF225, DF250 (2000+)  
 DF250AP, DF300AP (2012+)  
 DF300T/Z (2007-11)  
 DF325A, DF350A (2018+)



new

REF	OEM
REC17416-95J00	17416-95J00

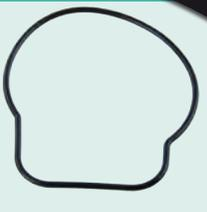
 DF20R, DF25R (VZ) (2006-13)  
 DF40A, DF50A, DF60A (2010+)



new

REF	OEM
REC17416-96J00	17416-96J00

 DF150AP, DF175AP, DF200AP (2017+)  
 DF150AT, DF175AT, DF200AT (2019)  
 DF150T, DF175T (G)/Z (2006-18)  
 DF200A, DF200AP (2015-17)  
 DF200AT/AZ (2018)



new

REF	OEM
REC17416-99E10	17416-99E10

 DF40A, DF50A, DF60A (2014+)  
 DF70A, DF80A, DF90A (2009+)  
 DF100B (2018+)

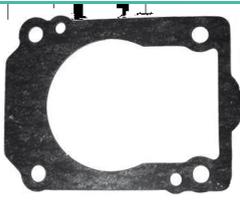
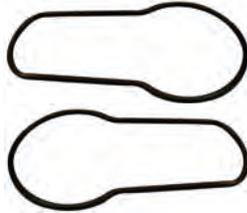

new

JUNTAS BOMBA	WATER PUMP GASKET	GUARNIZIONE POMPA	JOINTS POMPE										
<table border="1"> <thead> <tr> <th>REF</th> <th>OEM</th> </tr> </thead> <tbody> <tr> <td>REC17452-93910</td> <td>17452-93910</td> </tr> <tr> <td></td> <td>DF9.9, DF15T-K3 (1996-03) DT15C (1989-97) DT9.9K, DT15K-G-Y (1986-00) DT9.9, DT15 K1-K4 (2001-04)</td> </tr> </tbody> </table> 	REF	OEM	REC17452-93910	17452-93910		DF9.9, DF15T-K3 (1996-03) DT15C (1989-97) DT9.9K, DT15K-G-Y (1986-00) DT9.9, DT15 K1-K4 (2001-04)	<table border="1"> <thead> <tr> <th>REF</th> <th>OEM</th> </tr> </thead> <tbody> <tr> <td>REC17472-92D10</td> <td>17472-92D10</td> </tr> <tr> <td></td> <td>DT8C, DT9.9C-J-V (1988-97)</td> </tr> </tbody> </table> 	REF	OEM	REC17472-92D10	17472-92D10		DT8C, DT9.9C-J-V (1988-97)
REF	OEM												
REC17452-93910	17452-93910												
	DF9.9, DF15T-K3 (1996-03) DT15C (1989-97) DT9.9K, DT15K-G-Y (1986-00) DT9.9, DT15 K1-K4 (2001-04)												
REF	OEM												
REC17472-92D10	17472-92D10												
	DT8C, DT9.9C-J-V (1988-97)												
<table border="1"> <thead> <tr> <th>REF</th> <th>OEM</th> </tr> </thead> <tbody> <tr> <td>REC17472-91J00</td> <td>17472-91J00</td> </tr> <tr> <td></td> <td>DF4, DF5, DF6 (2002-14)</td> </tr> </tbody> </table> 	REF	OEM	REC17472-91J00	17472-91J00		DF4, DF5, DF6 (2002-14)	<table border="1"> <thead> <tr> <th>REF</th> <th>OEM</th> </tr> </thead> <tbody> <tr> <td>REC17472-98611</td> <td>17472-98611</td> </tr> <tr> <td></td> <td>DT4 / J4, DT5Y (1988-00) DT4K1 (2001) DT5Y (1998-02)</td> </tr> </tbody> </table> 	REF	OEM	REC17472-98611	17472-98611		DT4 / J4, DT5Y (1988-00) DT4K1 (2001) DT5Y (1998-02)
REF	OEM												
REC17472-91J00	17472-91J00												
	DF4, DF5, DF6 (2002-14)												
REF	OEM												
REC17472-98611	17472-98611												
	DT4 / J4, DT5Y (1988-00) DT4K1 (2001) DT5Y (1998-02)												
<table border="1"> <thead> <tr> <th>REF</th> <th>OEM</th> </tr> </thead> <tbody> <tr> <td>REC17472-93J00</td> <td>17472-93J00</td> </tr> <tr> <td></td> <td>DF200, DF225, DF250 (2004+) DF200A (2015) DF150, DF175T-Z (G) (2006-14)</td> </tr> </tbody> </table> 	REF	OEM	REC17472-93J00	17472-93J00		DF200, DF225, DF250 (2004+) DF200A (2015) DF150, DF175T-Z (G) (2006-14)	<table border="1"> <thead> <tr> <th>REF</th> <th>OEM</th> </tr> </thead> <tbody> <tr> <td>REC55122-94400</td> <td>55122-88L00</td> </tr> <tr> <td></td> <td>DF40, DF50X-K10 (1999-10) DF40A, DF50A, DF60A (2010+)</td> </tr> </tbody> </table> 	REF	OEM	REC55122-94400	55122-88L00		DF40, DF50X-K10 (1999-10) DF40A, DF50A, DF60A (2010+)
REF	OEM												
REC17472-93J00	17472-93J00												
	DF200, DF225, DF250 (2004+) DF200A (2015) DF150, DF175T-Z (G) (2006-14)												
REF	OEM												
REC55122-94400	55122-88L00												
	DF40, DF50X-K10 (1999-10) DF40A, DF50A, DF60A (2010+)												
<table border="1"> <thead> <tr> <th>REF</th> <th>OEM</th> </tr> </thead> <tbody> <tr> <td>REC17472-95310</td> <td>17472-95310</td> </tr> <tr> <td></td> <td>DT55, DT65J-X (1988-99)</td> </tr> </tbody> </table> 	REF	OEM	REC17472-95310	17472-95310		DT55, DT65J-X (1988-99)	<table border="1"> <thead> <tr> <th>REF</th> <th>OEM</th> </tr> </thead> <tbody> <tr> <td>REC17472-98503</td> <td>17472-98503</td> </tr> <tr> <td></td> <td>DT5, DF6, DT8G-Y (1986-00) DT6, DT8Y-K2 (2000-02)</td> </tr> </tbody> </table> 	REF	OEM	REC17472-98503	17472-98503		DT5, DF6, DT8G-Y (1986-00) DT6, DT8Y-K2 (2000-02)
REF	OEM												
REC17472-95310	17472-95310												
	DT55, DT65J-X (1988-99)												
REF	OEM												
REC17472-98503	17472-98503												
	DT5, DF6, DT8G-Y (1986-00) DT6, DT8Y-K2 (2000-02)												
<table border="1"> <thead> <tr> <th>REF</th> <th>OEM</th> </tr> </thead> <tbody> <tr> <td>REC17472-93911</td> <td>17472-93911</td> </tr> <tr> <td></td> <td>DF9.9, DF15T-K3 (1996-03) DT15C (1989-97) DT9.9K, DT15K-G-Y (1986-00) DT9.9, DT15K1-K4 (2001-04)</td> </tr> </tbody> </table> 	REF	OEM	REC17472-93911	17472-93911		DF9.9, DF15T-K3 (1996-03) DT15C (1989-97) DT9.9K, DT15K-G-Y (1986-00) DT9.9, DT15K1-K4 (2001-04)							
REF	OEM												
REC17472-93911	17472-93911												
	DF9.9, DF15T-K3 (1996-03) DT15C (1989-97) DT9.9K, DT15K-G-Y (1986-00) DT9.9, DT15K1-K4 (2001-04)												

CASQUILLO INOX	INSERT CUP	GHIERA INOX	INSERT INOX										
<table border="1"> <thead> <tr> <th>REF</th> <th>OEM</th> </tr> </thead> <tbody> <tr> <td>REC17413-95J00</td> <td>17413-95J00</td> </tr> <tr> <td></td> <td>DF40A, DF50A, DF60A (2010+) DF20R, DF25, RVZ (2006-11) DF20, DF25R, DF25QVZ (2013)</td> </tr> </tbody> </table> 	REF	OEM	REC17413-95J00	17413-95J00		DF40A, DF50A, DF60A (2010+) DF20R, DF25, RVZ (2006-11) DF20, DF25R, DF25QVZ (2013)	<table border="1"> <thead> <tr> <th>REF</th> <th>OEM</th> </tr> </thead> <tbody> <tr> <td>REC17413-92J01</td> <td>17413-92J01 17413-92J00</td> </tr> <tr> <td></td> <td>DF100A, DF115A, DF140A (2013+) DF140 (2002-12) DF90, DF100, DF115 (2001-11)</td> </tr> </tbody> </table> 	REF	OEM	REC17413-92J01	17413-92J01 17413-92J00		DF100A, DF115A, DF140A (2013+) DF140 (2002-12) DF90, DF100, DF115 (2001-11)
REF	OEM												
REC17413-95J00	17413-95J00												
	DF40A, DF50A, DF60A (2010+) DF20R, DF25, RVZ (2006-11) DF20, DF25R, DF25QVZ (2013)												
REF	OEM												
REC17413-92J01	17413-92J01 17413-92J00												
	DF100A, DF115A, DF140A (2013+) DF140 (2002-12) DF90, DF100, DF115 (2001-11)												
<table border="1"> <thead> <tr> <th>REF</th> <th>OEM</th> </tr> </thead> <tbody> <tr> <td>REC17413-99E11</td> <td>17413-99E11</td> </tr> <tr> <td></td> <td>DF40A, DF50A, DF60A (2014+) DF70A, DF80A, DF90A (2009+) DF100B (2018+)</td> </tr> </tbody> </table> 	REF	OEM	REC17413-99E11	17413-99E11		DF40A, DF50A, DF60A (2014+) DF70A, DF80A, DF90A (2009+) DF100B (2018+)	<table border="1"> <thead> <tr> <th>REF</th> <th>OEM</th> </tr> </thead> <tbody> <tr> <td>REC17413-96J01</td> <td>17413-96J01 17413-96J00</td> </tr> <tr> <td></td> <td>DF150, DF175 (2006+) DF200A, AP (2015+)</td> </tr> </tbody> </table> 	REF	OEM	REC17413-96J01	17413-96J01 17413-96J00		DF150, DF175 (2006+) DF200A, AP (2015+)
REF	OEM												
REC17413-99E11	17413-99E11												
	DF40A, DF50A, DF60A (2014+) DF70A, DF80A, DF90A (2009+) DF100B (2018+)												
REF	OEM												
REC17413-96J01	17413-96J01 17413-96J00												
	DF150, DF175 (2006+) DF200A, AP (2015+)												

**KITS DE REPARACIÓN BOMBA DE AGUA**

**WATER PUMP SERVICE KITS**

**KIT RICAMBI POMPA ACQUA**

**KIT POMPE À EAU**

REF	OEM
REC17400-95351	17400-95550 17400-95350 17400-95351

 DT75, DT85J-Y (1988-00)



REF	OEM
REC17400-93J01	17400-93J00 17400-93J01 17400-93J02 17400-93J03

 DF200, DF225, DF250 (2004+)



REF	OEM
REC17400-94701	17400-94700 17400-94701

 DT55, DT65J-X (1988-99)



REF	OEM
REC17400-98661	17400-98661 17400-986L0 17400-986L1

 DF4, DF5, DF6 (2002-15)



REF	OEM
REC17400-96403	17400-96350 17400-96351 17400-96352 17400-96403 17400-96353

 DT20, DT25, DT30G-Y (1986-00)  
DT40C-W-G-X (1986-99)  
DT25C, DT30C-K-Y (1989-00)  
DF25, DF30 (2000-07)  
DF40, DF50 (1999-10)



REF	OEM
REC17400-98J01	17400-98J00 17400-98J01 17400-98J02

 DF250AP, DF300AP (2012+)  
DF300T/Z (2007-11)



REF	OEM
REC17400-87D11	17400-87D10 17400-87D11 17400-87D00

 V6H-Y (1987-00)  
DT150, DT200, DT225W-K3 (1998-03)



REF	OEM
REC17400-98551	17400-98551

 DT5, DT6, DT8G-Y (1986-00)  
DT6, DT8Y-K2 (2000-02)



REF	OEM
REC17400-87E04	17400-87E03

 DT90, DT100L-Y (1990-00)  
DF60, DF70W-K9 (1998-09)

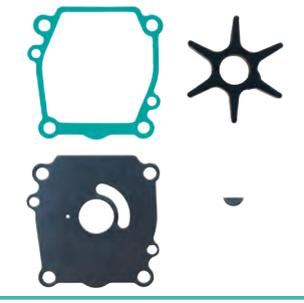

REF	OEM
REC17400-98652	17400-98652 17400-98661

 DT4 /J4, DT5Y (1988-02)  
DT4K1 (2001)



REF	OEM
REC17400-92D01	17400-92D01 17400-92D11

 DT8C, DT9.9C-J-V (1988-97)



REF	OEM
REC17400-93951	17400-93950

 DF9.9, DF15T-K3 (1996-03)  
DT9.9K, DT15K-G-Y (1986-00)  
DT15C (1989-97)

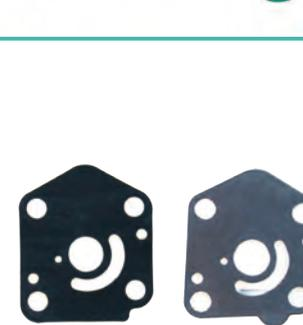

REF	OEM
REC17400-94611	17400-94611

DT115, DT140G-Y (1986-00)

REF	OEM
REC17400-94L00	17400-94L00

DF25A, DF30A (2014+)

REF	OEM
REC17400-90J20	17400-90J11

DF90, DF100, DF115K1-K11 (2001-11)  
DF140 (2002-11)

REF	OEM
REC17400-92J21	17400-92J21

DF100A, DF115, DF115A  
DF140A, DF150AP, DF175AP (2009+)

REF	OEM
REC17400-99J01	17400-99J00 17400-99J01

DF9.9A/AR/B (2010+)  
DF8A/AR  
DF15A  
DF20A

REF	OEM
REC17400-92J00	17400-92J200

DF90, DF100, DF115, DF140 (2006-08)

REF	OEM
REC17400-93912	17400-93911 17400-93912

DT9.9, DT15K1-K4 (2001-04)  
DT9.9K, DT15KG-Y (1986-00)

REF	OEM
REC17400-87L01	17400-87L00 17400-87L01

DF70A, DF80A, DF90A (2009+)

REF	OEM
REC17400-96J03	17400-96J00 17400-96J01 17400-96J02 17400-96J03

DF150, DF150G, DF150AP  
DF170, DF175G, DF175AP  
DF200A, DF200AP (2006+)

REF	OEM
REC17400-88L00	17400-88L00

DF40A, DF50A, DF60A (2010+)

**new**

REF	OEM
REC17400-94J00	17400-94J200

DF9.9, DF15 (2007+)

**new**

REF	OEM
REC17400-95J02	17400-95J01 17400-95J02

D25 V-TWIN (20106+)

**GUÍA  
KITS DE BOMBA DE AGUA**

**GUIDE OF WATER PUMP  
SERVICE KITS**

**GUIDA  
KIT POMPA ACQUA**

**GUIDE  
KIT POMPE À EAU**

2T STROKES	REF
DT4	1984-98 REC17400-98652
DT5	1992-02 REC17400-98652
DT6	1984-02 REC17400-98551
DT8	1986-97 REC17400-98551
DT9.9	1985-87 REC17400-98551
DT15C	1989-97 REC17400-98551
DT15	1983-88 REC17400-98551
DT8	1988-97 REC17400-92D01
DT9.9C	1989-00 REC17400-96403
DT25C	1988-97 REC17400-96403
DT30C	1988-97 REC17400-96403
DT20	1985-88 REC17400-96403
DT25C	1984-88 REC17400-96403
DT30C	1984-87 REC17400-96403
DT35	1983-98 REC17400-96403
DT40C	1983-98 REC17400-96403
DT55	1985-97 REC17400-94701
DT65	1985-97 REC17400-94701
DT75	1985-00 REC17400-95351
DT85	1985-00 REC17400-95351
DT115	1986-01 REC17400-94611
DT140	1986-01 REC17400-94611
V6	1986-03 REC17400-87D11

4T STROKES	REF
DF4	2002+ REC17400-98661
DF6	2010+ REC17400-99J01
DF9.9A	2010+ REC17400-99J01
DF9.9	2007+ REC17400-94J00
DF15	2007+ REC17400-94J00
DF9.9	1997-06 REC17400-93951
DF9.9B	1997-06 REC17400-93951
DF15	1997-06 REC17400-93951
DF15A	1997-06 REC17400-93951
DF20A	1997-06 REC17400-93951
DF25	2000-07 REC17400-96403
DF30	2000-07 REC17400-96403
DF40	1999-10 REC17400-96403
DF50	1999-10 REC17400-96403
DF25A	2014+ REC17400-94L00
DF30A	2014+ REC17400-94L00
DF60	1998-10 REC17400-87E04
DF70	1998-10 REC17400-87E04
DF40A	2010+ REC17400-88L00
DF50A	2010+ REC17400-88L00
DF60A	2010+ REC17400-88L00
DF70A	2010+ REC17400-88L00
DF80A	2009+ REC17400-87L01
DF90A	2009+ REC17400-87L01
DF90	2006-08 REC17400-92J00
DF100	2006-08 REC17400-92J00
DF115	2006-08 REC17400-92J00
DF140	2006-08 REC17400-92J00

REF	
DF90	2001-05 REC17400-90J20
DF115	2001-05 REC17400-90J20
DF140	2001-05 REC17400-90J20
DF100A	2009+ REC17400-92J21
DF115	2009+ REC17400-92J21
DF115A	2009+ REC17400-92J21
DF140A	2009+ REC17400-92J21
DF150AP	2006+ REC17400-96J03
DF175AP	2006+ REC17400-96J03
DF150	2006+ REC17400-96J03
DF150G	2006+ REC17400-96J03
DF150AP	2006+ REC17400-96J03
DF175	2006+ REC17400-96J03
DF175G	2006+ REC17400-96J03
DF175AP	2006+ REC17400-96J03
DF200A	2004+ REC17400-93J01
DF200AP	2004+ REC17400-93J01
DF200	2004+ REC17400-93J01
DF225	2004+ REC17400-93J01
DF250	2004+ REC17400-93J01
DF250SS	2007+ REC17400-98J01
DF300A	2007+ REC17400-98J01
DF300AP	2007+ REC17400-98J01



**ÁNODO**

**ANODE**

**ANODI**

**ANODE**

ZN (KG)	AL (KG)	OEM
0,018	0,023	55300-95500

DF9.9 (2004-10)  
DF15 (1996-03)  
DF40, DF50 (1999-10)  
DF40A, DF50A, DF60A (2010+)

ZN (KG)	AL (KG)	OEM
0,02	0,007	55321-87J00 55321-87J01

TORNILLO: PAGB/T5783-M6X14  
TÓRICA: REC09280-22019

ZN (KG)	AL (KG)	OEM
0,05	0,046	55320-98400

DF9.9, DF15 (1997-10)

ZN (KG)	AL (KG)	OEM
0,05		41811-98500

DT4, DT15  
DF9.9, DF15

ZN (KG)	AL (KG)	OEM
0,08	0,03	55320-95310

DF25 --- DF300 (2000+)

ZN (KG)	AL (KG)	OEM
0,51	0,21	55320-94900

DF60 --- DF300 HP

ZN	(KG)	AL	(KG)	OEM
CM55125-95500	0,25	CM55125-95500A	0,087	55125-87E01

DF40, DF50 (1999-10)  
DF40A, DF50A, DF60A (2010+)

ZN	(KG)	AL	(KG)	OEM
CM55125-94502	0,33			55125-94502

DT115 --> DT140 (1986-00)

ZN	(KG)	AL	(KG)	OEM
CM55321-93900	0,08	CM55321-93900A	0,02	55320-93900

DF9.9, DF15 (1997-08)

ZN	(KG)	AL	(KG)	OEM
CM55320-98600	0,10	CM55320-98600A	0,034	55320-98600

DT4, DT5 (1988-02)

ZN	(KG)	AL	(KG)	OEM
CM55321-93900	0,08	CM55321-93900A	0,02	55320-93900
CM55125-87D00	0,34	CM55125-87D00A	0,14	55320-93900 55125-87801

50 --> 250 HP

ZN	(KG)	AL	(KG)	OEM
CM55321-90J01	0,08	CM55321-90J01A	0,036	55321-90J01

DF60, DF70, DF90, DF115, DF140 (1998-10)

ZN	(KG)	AL	(KG)	OEM
CM55125-96310	0,13	CM55125-96310A	0,07	55125-96310

20, 25, 30, 40 50 HP (1983-10)  
DF25, DF30 (2000-10)  
DF25 V-TWIN (2006+)

ZN	(KG)	AL	(KG)	OEM
CM11130-94600	0,02	CM11130-94600A	0,01	11130-94600

DT4 --> DT140 (1986-2002)

TORNILLO  
PAGB/T5783-M6X14

AL	(KG)	OEM
CM55125-95301A	0,06	55125-95301

55, 65 HP

**KITS DE ÁNODOS      ANODES KIT      KIT ANODI      KIT ANODES**

AL	OEM
CMSZ90140KITA	90, 100, 115, 140 hp

**Martyr Premium**  
SUZUKI 90-100-115-140 HP ANODE KIT  
SALT AND BRACKISH WATER

AL	OEM
CMSZ4050KITA	40 - 50 hp

**Martyr Premium**  
SUZUKI 40-50 HP ANODE KIT  
SALT AND BRACKISH WATER

**ÁNODO**

**ANODE**

**ANODI**

**ANODE**

ZN	OEM	(KG)
TEN01208	55300-95500	0,08

DF9.9 (2004-10)  
DF15 (1996-03)  
DF40, DF50 (1999-10)  
DF40A, DF50A, DF60A (2010+)



ZN	OEM	(KG)	Ø
TEN01210	55320-98400	0,05	7 mm
TEN01210/1	41811-98500	0,05	M6

DF9.9, DF15 (1997-10)



ZN	OEM	(KG)
TEN01212	55321-90J01	0,10

DF60, DF140 (1998-10)



ZN	OEM	(KG)	TORNILLO	TÓRICA
TEN01213	55321-87J00 55321-87J01	0,02	PAGB/T5783-M6X14	REC09280-22019

DF8 --> DF300



ZN	(KG)	AL	(KG)	OEM
TEN01214	0,51	TEN01214AL	0,20	55320-94900

DF60 --> DF30 HP



ZN	(KG)	OEM
TEN01202	0,095	55320-98600

DT4, DT5 (1988-02)



ZN	OEM	(KG)
TEN01211	55125-87D00 55120-87801	0,31

50 --> 70 HP  
DT150, DT175, DT200, DT225  
4T



ZN	OEM	(KG)
TEN01215	55125-90J01	0,25

Serie 7DF60- DF70  
DF90 --> DF140 (1998+)

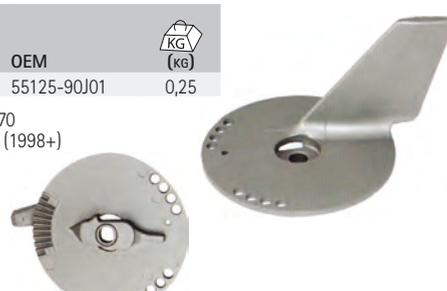

ZN	OEM	(KG)
TEN01200	55125-96310	0,15

20, 25, 30 HP  
DF25, DF30 (2000-10)  
DF25 V-TWIN (2006+)



ZN	(KG)	AL	(KG)	OEM
TEN01204	0,08	TEN01204AL	0,03	55320-98311 55320-95310

DF25, DF300 (2010+)



ZN	(KG)	OEM
TEN01201	0,16	55125-95301

DF40, DF50 (1999-10)  
DF40A, DF50A, DF60A (2010+)



ZN	(KG)	OEM
TEN01206	0,05	55321-93900

DF9.9, DF15 (1997-08)



ZN	(KG)	OEM
TEN01207	0,19	55321-95500 55320-98600

75, 85, 90 HP





ZN	OEM	 (KG)
TEN01203	41810-87D00	0,15



ZN	 (KG)	OEM
TEN01209	0,33	55321-94502 55125-94502

115 HP



ZN	 (KG)	OEM	TORNILLO
TEN01205	0,01	11130-94600	PAGB/T5783-M6X14

DT4 --> DT140 (1986-02)



ZN	 (KG)	OEM
TEN01166	0,03	11281-94400

DT8 --> DT65 (1986-00)  
DF60, DF70 (1998-09)



**new**

**TORNILLO INOX      SS SCREW      VITE INOX      VIS INOX**

REF	OEM	ÁNODO ANODE ANODO ANODE
PAGB/T5783-M6X14	09103-06281	CM55321-87J00 CM11130-94600 TEN01213 TEN01205



**new**

REF	OEM	ÁNODO ANODE ANODO ANODE
PAGB/T818-M6X14	09128-06221	11130-94600



**new**

REF	OEM	ÁNODO ANODE ANODO ANODE	
REC09116-06121	09116-06121	55321-94900	6 X 25



**new**

REF	OEM	ÁNODO ANODE ANODO ANODE	
REC09116-06094	09116-06094	55321-93J00	6 X 15



**new**

**JUNTA TÓRICA      O-RING      O-RING      JOINT TORIQUE**

REF	OEM	ÁNODO ANODE ANODO ANODE
REC09280-22019	09280-22019	CM55321-87J00 TEN01213



**new**

**JUNTA TAPA DEL ÁNODO      GASKET, ANODE COVER      GUARNIZIONE, COPERCHIO ANODO      JOINT, COUVERCLE D'ANODE**

REF	OEM
REC11265-87E10	11265-87E00 11265-87E00-H17

DF25 --> DF140



**new**

# PARTES DEL MOTOR ENGINE PARTS

# PARTI MOTORE PIECES MOTEUR

DESPIECE MOTOR  
DE 2 TIEMPOS

ENGINE PARTS  
2 STROKES

PARTI MOTORI  
2 TEMPI

PIECES DE MOTEURS  
2 TEMPS

2T  
STROKES DT40C-W-G-X (1986-99)  
DTW-K1-KA (2001-04)

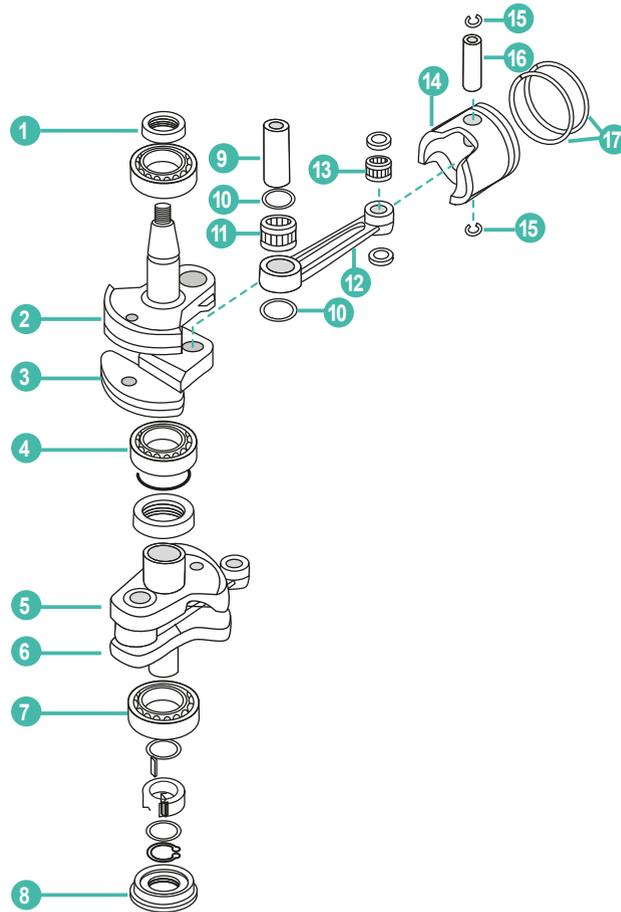

	REF	OEM					UN.
1	REC09283-35043	09283-35043	RETÉN	OIL SEAL	PARAOLIO	JOINT SPI	1
2	REC12221-94412	12221-94412	CIGÜEÑAL 1	CRANKSHAFT 1	ALBERO MOTORE 1	VILEBREQUIN 1	1
3	REC12231-94413	12231-94413	CIGÜEÑAL 2	CRANKSHAFT 2	ALBERO MOTORE 2	VILEBREQUIN 2	1
4	REC09269-30012	09269-30012	RODAMIENTO	BEARING	CUSCINETTO	ROULEMENT	1
5	REC12232-94412	12232-94412	CIGÜEÑAL 3	CRANKSHAFT 3	ALBERO MOTORE 3	VILEBREQUIN 3	1
6	REC12240-94432	12240-94432	CIGÜEÑAL 4	CRANKSHAFT 4	ALBERO MOTORE 4	VILEBREQUIN 4	1
7	REC09262-35052	09262-35052	RODAMIENTO	BEARING	CUSCINETTO	ROULEMENT	1
8	REC09283-30062	09283-30062	RETÉN	OIL SEAL	PARAOLIO	JOINT SPI	1
9	REC12211-94410	12211-94410	BULON CIGÜEÑAL	PIN CRANK	SPINOTTO	CLAVETTE	2
10	REC09160-27008	09160-27008	ARANDELA	WASHER	RONDELLA	RONDELLE	4
11	REC09263-27005	09263-27005	COJINETE BIELA	ROD BEARNG	CUSCINETTO BIELLA	ROULEMENT DE BIELLE	2
12	REC12161-94400	12161-94400	BIELA	CONNECTING ROD	BIELLA	BIELLE	2
13	REC09263-20072	09263-20072	COJINETE BIELA	ROD BEARNG	CUSCINETTO BIELLA	ROULEMENT DE BIELLE	2
14	REC12110-94400K	12110-94400K	KIT PISTON	PISTON KIT	KIT PISTONE	KIT PISTON	2
15	REC09381-20003	09381-20003	CLIP	CNAP RING	CLIP	CLIP	4
16	REC12151-94400	12151-94400	PIN	PIN	SPINA	AXE DE PISTON	2
17	REC12140-94400	12140-94400	KIT SEGMENTOS	RING SET	SET FASCE	KIT DE SEGMENTS	2

DESPIECE MOTOR  
DE 4 TIEMPOS

ENGINE PARTS  
4 STROKES

PARTI MOTORI  
4 TEMPI

PIECES DE MOTEURS  
4 TEMPS

4T DF40, DF50 (1999-10)  
STROKES

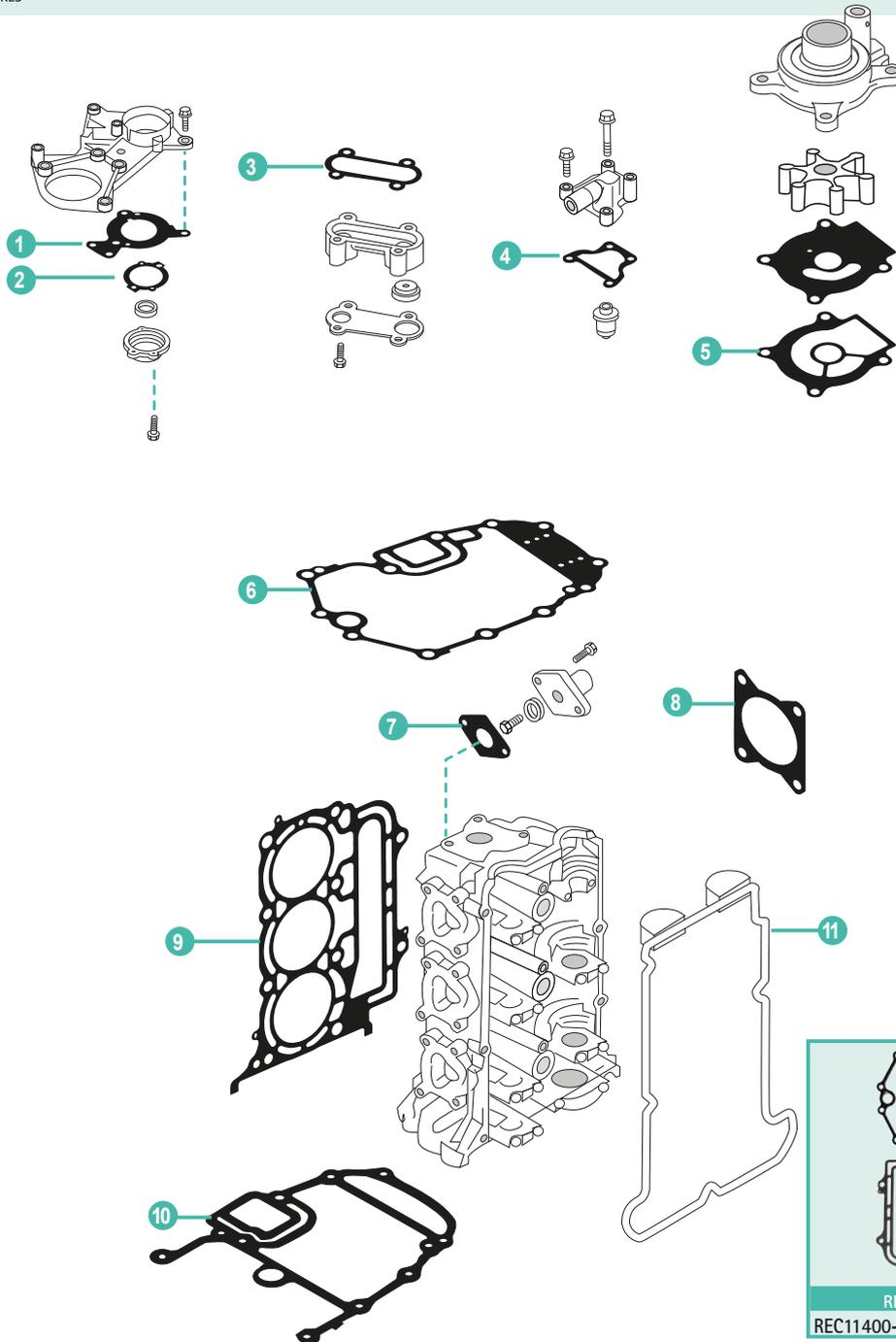

REF	OEM
REC11400-87804	11400-87804

	REF	OEM				
1	REC11413-87J00	11413-87J00	RETÉN SUPERIOR	SEAL UPPER	PARAOLIO SUPERIORE	JOINT SPI
2	REC11433-87J00	11433-87J00	JUNTA DEL RETÉN SUPERIOR	SEAL UPPER, GASKET	GUARNIZIONE PARAOLIO SUPERIORE	JOINT SPI
3	REC17616-87J00	17616-87J00	JUNTA DE LA VÁLVULA DE PRESIÓN	PRESURE VALVE, GASKET	GUARNIZIONE, VALVOLA PRESIONE	JOINT SOUPAPE DE PRESSION
4	REC17685-87D10	17685-87D10	JUNTA TAPA DE TERMOSTATO	THERMOSTAT COVER GASKET	GUARNIZIONE COPERCHIO TERMOSTATO	JOINT LOGEMENT THERMOSTAT
5	REC17472-96303	17472-96303	JUNTA DE LA BOMBA DE AGUA	WATER PUMP, GASKET	GUARNIZIONE POMPA ACQUA	JOINT POMPE À EAU
6	REC11489-87J00	11489-87J00	JUNTA DEL CÁRTER	OIL PAN, GASKET	GUARNIZIONE COPPA OLIO	JOINT DE CARTER
7	REC11265-87E10	11265-87E10	JUNTA TAPA DEL ÁNODO	GASKET, COVER ANODE	GUARNIZIONE COPERCHIO ANODO	JOINT D'ANODE D'ECHAPPEMENT
8	REC13421-87J00	13421-87J00	JUNTA DEL CUERPO DE MARIPOSA	THRPTTLE BODY GASKET	GUARNIZIONE CORPO FARFALLATO	JOINT DE THROTTLE BODY
9	REC11141-87J02	11141-87J02	JUNTA DE CULATA	CYLINDER HEAD, GASKET	GUARNIZIONE TESTATA	JOINT DE CULASSE
10	REC51211-87J00	51211-87J00	JUNTA BASE MOTOR	GASKET ENGINE	GUARNIZIONE BASE MOTORE	JOINT DE TÊTE MOTRICE
11	REC11189-87J00	11189-87J00	JUNTA TAPA DE BALANCÍN	GASKET CYLINDER COVER	GUARNIZIONE COPERCHIO PUNTERIE	JOINT COUVERCLE

4T DF70A, DF80A, DF90A, DF100B (2009+)  
STROKES

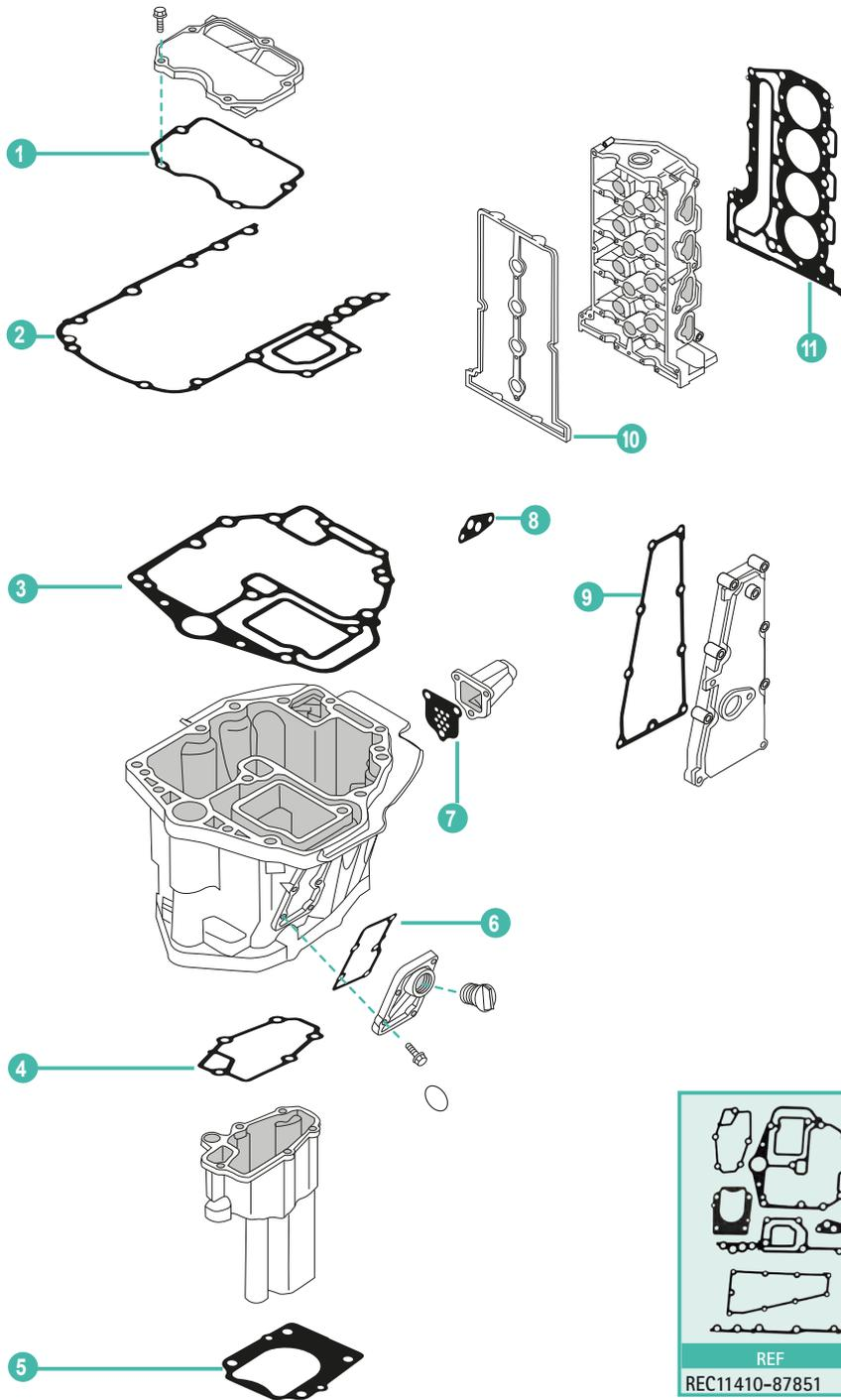

	REF	OEM				
1	REC51123-87L00	51123-87L00	JUNTA DE LA TAPA DE SILEMBLOCK	GASKET, MOUNT CASE COVER	GUARNIZIONE COPERCHIO SILEMBLOCK	JOINT DE COUVERCLE SILEMBLOCK
2	REC51211-87L10	51211-87L00 51211-87L10	JUNTA BASE MOTOR	ENGINE HOLDER GASKET	GUARNIZIONE BASE MOTORE	JOINT BASE MOTEUR
3	REC11489-87L00	11489-87L00	JUNTA CARTER	OIL PAN GASKET	GUARNIZIONE COPPA	JOINT DE CARTER
4	REC52331-87L00	52331-87L00	JUNTA TAPA DE ESCAPE	GASKET EXHAUST COVER	GUARNIZIONE COPERCHIO SCARICO	JOINT DE COUVERCLE D'ECHAPPEMENT
5	REC17472-87L00	17472-87L00	JUNTA BOMBA DE AGUA	WATER PUMP GASKET	GUARNIZIONE POMPA ACQUA	JOINT DE POMPE À EAU
6	REC52331-87L00	52331-87L00	JUNTA TAPA ESCAPE	GASKET EXHAUST COVER	GUARNIZIONE COPERCHIO SCARICO	JOINT DE COUVERCLE D'ECHAPPEMENT
7	REC11542-87L00	11542-87L00	JUNTA MÚLTIPLE DE ESCAPE	MULTI EXHAUST GASKET	GUARNIZIONE SCARICO MULTIPLO	JOINT DE PIPE D'ECHAPPEMENT
8	REC16539-87L00	16539-87L00	JUNTA ADAPTADOR DE FILTRO	FILTER ADAPTER GASKET	GUARNIZIONE ADATTATORE DE FILTRO	JOINT D'ADAPTEUR DE FILTRE
9	REC14151-87L00	11151-87L00	JUNTA TAPA ESCAPE	GASKET EXHAUST COVER	GUARNIZIONE COPERCHIO SCARICO	JOINT DE COUVERCLE D'ECHAPPEMENT
10	REC11189-87L00	11189-87L00	JUNTA TAPA DE CULATA	GASKET CYLINDER HEAD COVER	GUARNIZIONE COPERCHIO TESTATA	JOINT DE COUVERTURE DE CULASSE
11	REC11141-87L00	11141-87L00	JUNTA DE CULATA	CYLINDER-HEAD GASKET	GUARNIZIONE TESTATA	JOINT DE CULASSE

ÁRBOL DE LEVAS

CAMSHAFT

ALBERO A CAMME

ARBRE A CAMES

REF	OEM
REC12710-97J00	12710-97J00

DF2.5 (2006+)



*new*



REF  
STA82910

JUNTAS DE MOTOR  
4 TIEMPOS

ENGINE GASKET  
4 STROKES

GUARNIZIONI  
MOTORE 4 TEMPI

JOINTS DE MOTEUR  
4 TEMPS

4T  
STROKES

JUNTAS DE CULATA

CYLINDER HEAD GASKET

GUARNIZIONE TESTA

JOINT DE CULASSE

REF	OEM
REC11141-97J02	11141-97JL0 11141-97J01

DF2.5 (2006-15)



REF	OEM
REC11141-87J02	11141-87J00 11141-87J01 11141-87J02

DF40, DF50 (1999-10)

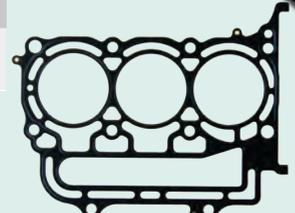

*new*

REF	OEM
REC11141-91JL0	11141-91JL0 11141-91J01 11141-91J02

DF4, DF5, DF6 (2002-15)



*new*

REF	OEM
REC11141-90J01	11141-90J00

DF90, DF100, DF115K1-K11 (2001-11)

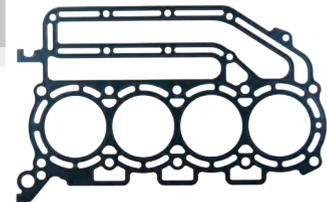

REF	OEM
REC11141-93E20	11141-93E20

DF9.9, DF15T-K3 (1996-03)  
DF9.9, DF15 (R) (2004-11) MY04



REF	OEM
REC11141-92J01	11141-92J00

DF100A, DF115A, DF140A (2013+)  
DF140 (2002-12)

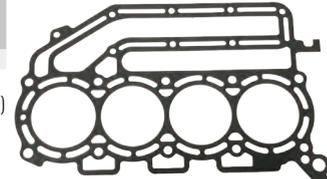

REF	OEM
REC11141-95J00	11141-95J00

DF20, DF25, DF25R V2 (2006-11)



REF	OEM
REC11142-93J10	11142-93J03
REC11141-93J10	11141-93J03

DF200, DF225, DF250 (2004+)

BABOR | PORT | BABORDO | GAUCHE  
ESTRIBOR | STD | TRIBORDO | DROIT



REF	OEM
REC11141-87L00	11141-87L00

DF70A, DF80A, DF90A, DF100B (2009+)

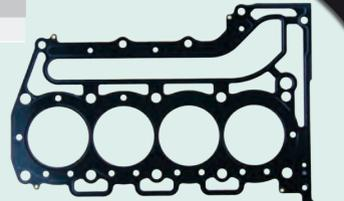

*new*

REF	OEM
REC11142-98J10	11142-98J00
REC11141-98J10	11141-98J01

DF300AP (2012)  
DF300T-Z (2007-11)

BABOR | PORT | BABORDO | GAUCHE  
ESTRIBOR | STD | TRIBORDO | DROIT



SUZUKI

RECAMBIOS  
MARINOS

4T  
STROKESGUÍA  
JUNTAS DE CULATACYLINDER HEAD GASKET  
GUIDEGUIDA  
GUARNIZIONE TESTAGUIDE  
JOINTS DE CULASSE

		REF	RO OEM
DF2.5	2006-15	REC11141-97J02	11141-97JL0
			11141-91JL0
DF4, DF5, DF6	2002-15	REC11141-91JL0	11141-91J01
			11141-91J02
DF9.9, DF15 T-K3	1996-03	REC11141-93E20	11141-93E20
DF9.9, DF15 R	2004-11	REC11141-93E20	11141-93E20
DF20, DF25 R-V2	2006-11	REC11141-95J00	11141-95J00
			11141-87J00
DF40, DF50	1999-10	REC11141-87J02	11141-87J01
			11141-87J02
DF70A, DF80A, DF90A, DF100B	2009+	REC11141-87L00	11141-87L00

		REF	RO OEM
DF90, DF100, DF115 K1-K11	2001-11	REC11141-90J01	11141-90J01
DF100A, DF115A, DF140A	2013	REC11141-92J01	11141-92J00
DF140	2002-12	REC11141-92J01	11141-92J00
DF200, DF225, DF250 V6 (STB)	2004	REC11141-93J10	11141-93J03
DF200, DF225, DF250 V6 (PORT)	2004	REC11142-93J10	11142-93J03
DF300 T/Z V6 (STB)	2007-11	REC11141-98J10	11141-98J01
DF300 T/Z V6 (PORT)	2007-11	REC11141-98J10	11142-98J00
DF300 AP V6 (STB)	2012-12	REC11141-98J10	11141-98J01
DF300 AP V6 (PORT)	2012-12	REC11141-98J10	11142-98J00

4T  
STROKESKITS  
JUNTAS DE CULATACYLINDER HEAD GASKET  
KITKIT  
GUARNIZIONE TESTAKITS  
JOINTS MOTEUR

REF	OEM
REC11400-87804	11400-87804
	11400-87803
	11400-87802
	11400-87801
	11400-87800

DF40, DF50 (1999-10)

REF	OEM
REC11410-87851	11410-87851
	11410-87850

DF70A, DF80A, DF90A, DF100B (2009+)

4T  
STROKES

## JUNTAS BASE DE MOTOR

## CYLINDER GASKET

GUARNIZIONE  
BASE MOTORE

## JOINTS DE TÊTE MOTRICE

REF	OEM
REC51211-90J10	51211-90J00
	51211-90J01
	51211-90J02
	51211-90J10

DF90, DF100, DF115 K1-K11 (2001-11)  
DF140 (2002-12)

Motores antiguos  
Old engines  
Motore vecchio  
Moteurs anciennes

REF	OEM
REC51211-87L10	51211-87L00
	51211-87L10

DF70A, DF80A, DF90A, DF100B (2009+)

REF	OEM
REC51211-93J00	51211-93J00

DF200, DF225, DF250 (2004-15)  
DF300AP (2012)  
DF300T/Z (2007-11)

REF	OEM
REC51211-87J00	51211-87J00

DF40, DF50 (1999-10)

REF	OEM
REC51211-90J2	51211-90J21
	51211-90J22

DF90, DF100, DF115, DF140  
DF100A, DF115A, DF140A (2013+)

Motores modernos  
New engines  
Motore moderno  
Moteurs modernes

SUZUKI

RECAMBIOS  
MARINOS

**4T STROKES**    **JUNTAS BASE ACEITE**    **GASKET, UNDER OIL**    **GUARNIZIONE BASE OLIO**    **JOINTS BASE D'HUILE**

REF	OEM
REC51142-93J00	51142-93J00
DF200, DF225, DF250 (2004+)	
DF300AP (2012)	
DF300T-Z (2007-11)	



**4T STROKES**    **JUNTAS BASE RETÉN**    **GASKET, MOUNT OIL SEAL COVER**    **GUARNIZIONE BASE PARAOLIO**    **JOINT DE COUVERCLE**

REF	OEM
REC51123-93J00	51123-93J00
DF200, DF225, DF250 (2004+)	
DF300AP (2012)	
DF300T/Z (2007-11)	

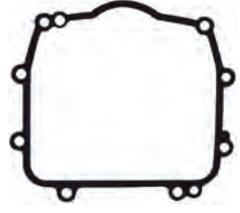

**4T STROKES**    **JUNTAS GUÍA CADENA**    **GASKET, TIMING CHAIN GUIDE BASE**    **GUARNIZIONE CARTER CATENA GUIDA BASE**    **JOINT DE GUIDE CHAINE**

REF	OEM
REC12778-93J00	12778-93J00
DF200, DF225, DF250 (2004+)	
DF300AP (2012)	
DF300T/Z (2007-11)	



**4T STROKES**    **JUNTAS ACEITE**    **GASKET, OIL GALLERY**    **GUARNIZIONE OLIO**    **JOINT D'HUILE**

REF	OEM
REC16433-93J00	16433-93J00
DF200, DF225, DF250 (2004+)	
DF300AP (2012)	
DF300T/Z (2007-11)	



REF	OEM
REC11552-87L00	11552-87L00
DF70A, DF80A, DF90A, DF100B (2000+)	

REF	OEM
REC17693-95J00	17693-95J00
DF20R, DF25, DF25R V2 (2006-11)	



**4T STROKES**    **JUNTAS CUERPO DE MARIPOSA**    **GASKET, THROTTLE BODY**    **GUARNIZIONE CORPO FARFALLATO**    **JOINT DE THROTTLE BODY**

REF	OEM
REC13421-98J00	13421-98J00
DF300AP (2012)	
DF300T/Z (2007-11)	



REF	OEM
REC13421-87J00	13421-87J00
DF40, DF50	

**4T STROKES**    **JUNTA TAPA DE FILTRO**    **GASKET, FILTER COVER**    **GUARNIZIONE COPERCHIO FILTRO**    **JOINT COUVERCLE DE FILTRE**

REF	OEM
REC16539-87L00	16539-87L00
DF70A, DF80A, DF90A, DF100B (2009+)	



**4T STROKES** JUNTA TAPA DE SILEMBLOCK GASKET, SILEMBLOCK COVER GUARNIZIONE COPERCHIO SILEMBLOCK JOINT DE COUVERCLE SILEMBLOCK

REF	OEM
REC51123-87L00	51123-87L00

DF70A, DF80A, DF90A, DF100B (2009+)

*new*

**4T STROKES** JUNTA TAPA DE BALANCINES GASKET, CYLINDER COVER GUARNIZIONE COPERCHIO PUNTERIE JOINT DE CACHE CULBUTEUR

REF	OEM
REC11189-87L00	11189-87L00

DF70A, DF80A, DF90A, DF100B (2009+)

*new*

REF	OEM
REC11189-87J00	11189-87J00

DF40, DF50 (1999-10)

*new*

**4T STROKES** JUNTA TAPA DE TERMOSTATO GASKET, THERMOSTAT COVER GUARNIZIONE COPERCHIO TERMOSTATO JOINT LOGEMENT THERMOSTAT

REF	OEM
REC17685-87D10	17685-87D10 17685-87D00

DF40, DF50 (1999-10)  
V6 H-Y (1987-00)

*new*

**4T STROKES** JUNTA VÁLVULA DE PRESION GASKET, PRESSURE VALVE GUARNIZIONE VALVOLA PRESSIONE JOINT SOUPAPE DE PRESSION

REF	OEM
REC17616-87J00	17616-87J00

DF40, DF50 (1999-10)

*new*

**4T STROKES** JUNTA RETÉN SUPERIOR GASKET, UPPER SEAL GUARNIZIONE PARAOLIO SUPERIORE JOINT D'HUILE SUPERIEUR

REF	OEM
REC11413-87J00	11413-87J00

DF40, DF50 (1999-10)

*new*

REF	OEM
REC11433-87J00	11433-87J00

DF40, DF50 (1999-10)

*new*



2T  
STROKES

**JUNTAS DE MOTOR  
2 TIEMPOS**

**ENGINE GASKET  
2 STROKES**

**GUARNIZIONI  
MOTORE 2 TEMPI**

**JOINTS DE MOTEUR  
2 TEMPS**

**JUNTAS DE CULATA**

**CYLINDER HEAD GASKET**

**GUARNIZIONE TESTA**

**JOINT DE CULASSE**

REF	OEM
REC11141-98401	11141-98401

DT2, DT2.2 G-Y (1686-00)



REF	OEM
REC11141-96344	11141-96344

DT25, DT30 K1-K2 (2001-02)



REF	OEM
REC11141-98130	11141-98130

DT5, DT6, DT8 G-Y (1986-00)  
DT6, DT8 Y-KS (2000-02)



REF	OEM
REC11141-94450	11141-94450

DT40C-W-G-X (1986-99)



REF	OEM
REC11141-93960	11141-93950

DT9.9D, DT15K-G-Y (1986-00)  
DT9.9, DT15K1-K4 (2001-04)  
DT15C (1989-97)





REF	OEM
REC11141-94720	11141-94701 11141-94720

DT55, DT65J-X (1988-99)

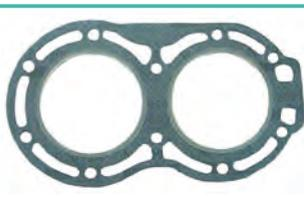

REF	OEM
REC11141-96303	11141-96344

DT20, DT25, DT30G-Y (1986-00)

REF	OEM
REC11141-95505	11141-95505 11141-95621

DT75, DT85J-Y (1988-00)



REF	OEM
REC11141-95D40	11141-95D40

DT25C, DT30C-K-Y (1989-00)



REF	OEM
REC11141-87E90	11141-87D90 11141-87E20

DT25C, DT30C-K-Y (1989-00)



REF	OEM
REC11141-94506	11141-94506 11141-94620

DT115, DT140G-Y (1986-00)  
4 In line



REF	OEM
REC11141-87D90	11141-87D90 11141-87D61

150/200 HP (1986)  
V6



2T  
STROKES

**GUÍA  
JUNTAS DE CULATA**

**CYLINDER HEAD GASKET  
GUIDE**

**GUIDA  
GUARNIZIONE TESTA**

**GUIDE  
JOINTS DE CULASSE**

		REF	RO OEM
DT2.2, DT2.2 G-Y	1986-00	REC11141-98401	11141-98411
DT5, DT6, DT8 G-Y	1986-00	REC11141-98130	11141-98130
DT6, DT8 Y-K2	2000-02	REC11141-98130	11141-98130
DT9.9K, DT15 K-G-Y	1986-00	REC11141-93960	11141-93950
DT9.9, DT15 K1-K4	2001-04	REC11141-93960	11141-93950
DT15C	1989-97	REC11141-93960	11141-93950
DT20, DT25, DT30 G-Y	1986-00	REC11141-96303	11141-96344
DT25, DT30 C-K-Y	1989-00	REC11141-95D40	11141-95D40
DT25, DT30 K1-K2	2001-01	REC11141-96344	11141-96343

		REF	RO OEM
DT40 C-W-G-X	1986-99	REC11141-94450	11141-94440
DT55, DT65 J-X	1988-99	REC11141-94720	11141-94720
DT75, DT85 J-Y	1988-00	REC11141-95505	11141-95621
DT90, DT100 L-Y	1990-00	REC11141-87E90	11141-87E20
DT115, DT140 G-Y	1986-00	REC11141-94506	11141-94620
DT150, DT200, V6	1986-86	REC11141-87D90	11141-87D61
DT150, DT200, DT225 W-K3	1998-03	REC11141-87D92	11141-87D32

SUZUKI

RECAMBIOS  
MARINOS

2T  
STROKES

JUNTAS DE CULATÍN

GASKET, HEAD COVER

GUARNIZIONE COPERCHIO TESTA

JOINTS DE COUVRE CULASSE

REF	OEM
REC11162-94410	11162-94410

DT40C-WG-X (1986-99)  
DT40W K1-K4 (2001-04)

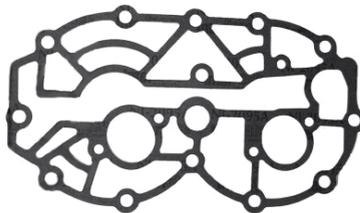

2T  
STROKES

JUNTAS BASE ACEITE

GASKET, UNDER OIL

GUARNIZIONE BASE OLIO

JOINTS DE TÊTE MOTRICE

REF	OEM
REC11433-93912	11433-93901

DT9.9, DT15 K1-K4 (2001-04)  
DT9.9K, DT15K-G-Y (1986-00)

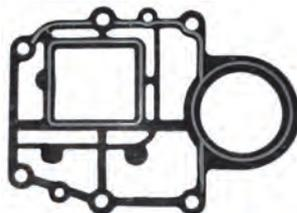

REF	OEM
REC11433-96330	11433-96302

DT20, DT25, DT30G-Y (1986-00)  
DT25, DT30 K1-K2 (2001-02)

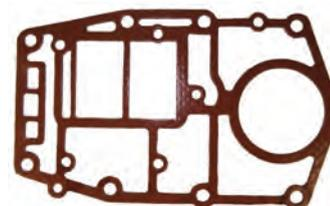

REF	OEM
REC11433-94412	11433-94401

DT40C-W-G-X (1986-00)

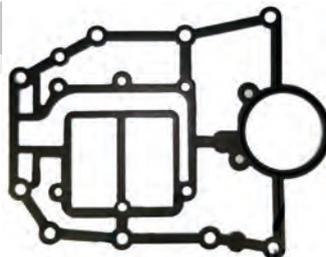

2T  
STROKES

JUNTA TAPA DE TERMOSTATO

GASKET, THERMOSTAT COVER

GUARNIZIONE COPERCHIO TERMOSTATO

JOINT LOGEMENT THERMOSTAT

REF	OEM
REC17685-87D10	17685-87D10 17685-87D00

DT150, DT200, DT225 (1998-03)  
DT90, DT100 (1990-00)



new

RETENES DE ACEITE OIL SEALS

PARAOLIO

JOINT SPI

RETÉN DE ACEITE

OIL SEAL

PARAOLIO

JOINT SPI

REF	OEM	Dimensions
REC09282-10008	09282-10008	10 x 21 x 4.5 mm

DF2.5 (2006-13)  
DF4, DF5, DF6 (2002+)  
DT4/J4, DT5Y (1988-02)  
DT4K1 (2001)



REF	OEM	Dimensions
REC09283-17002	09283-17002	17 x 29 x 7 mm

DT2, DT2.2G-Y (1986-00)  
DT2.2 K1-K5 (2001-05)



REF	OEM	Dimensions
REC09282-12008	09282-12008	12 x 24 x 4.5 mm

DF2.5 (2012)  
DTK1 (2001)  
DF4, DF5, DF6 (2002-12)  
DT4, J4, DT5Y (1988-02)  
DT8, DT9.9C-J-V (1988-97)



REF	OEM	Dimensions
REC09283-20018	09283-20018	20 x 37 x 9 mm

DT4K1 (2001)  
DT4, J4, DT5Y (1988-02)  
DT8, DT9.9C-J-V (1988-97)  
DT15C (1989-97)



REF	OEM		
REC09282-12010	09282-12010	12 x 25 x 7 mm	
	DF9.9, DF15 (R) (2004-12) DF9.9, DF15T-K3 (1996-03) DT15C (1989-97) DT9.9K, DT15K-G-Y (1986-00) DT9.9, DT15K1-K4 (2001-04)		

REF	OEM		
REC09282-15008	09282-15008	14.7 x 25 x 6.5 mm	
	DF20R, DF25, DF25RVZ (2006-11) DT20, DT25, DT30G-Y (1986-00) DT25, DT301-K2 (2001-02)		

REF	OEM		
REC09282-17005	09282-17005	17 x 32 x 6 mm	
	DF40, DF50X-K10 (1999-10) DF40A, DF50A, DF60A (2010+) DT40X-W-G-X (1986-99) DT40W-K1-K4 (2001-04)		

REF	OEM		
REC09282-17009	09282-17009	17 x 28 x 6 mm	
	DF25, DF30W-K6 (2000-06) DF40, DF50Y-K10 (1999-10) DT25C, DT30C-K-Y (1989-00) DT40C-W-G-X (1986-99) DT40W-K1-K4 (2001-04) DT55, DT65J-X (1988-99)		

REF	OEM		
REC09283-10003	09283-10003	10 x 22 x 6 mm	
	DT4 J4, DT5Y (1988-02) DT4K1 (2001) DT5, DT6, DT8G-Y (1986-00) DT6, DT8Y-K2 (2000-02)		

REF	OEM		
REC09283-10009	09283-10009	10 x 45 x 5 mm	
	DF4, DF5, DF6 (2002+)		

REF	OEM		
REC09283-35043	09283-35043	35 x 55 x 7 mm	
	DT40C-W-G-X (1986-99) DT40WK1-K4 (2001-04) DT55, DT65J-X (1988-99)		

REF	OEM		
REC09289-10005	09289-10005		
	DT2, DT2.2G-Y (1986-00) DT2.2 K1-K5 (2001-05)		

REF	OEM		
REC09283-30064	09283-30064	30 x 55 x 10 mm	
	DT20, DT25, DT30G-Y (1986-00) DT25, DT30K1-K2 (2001-02)		

REF	OEM		
REC09283-20045	09283-20045		
	DT4 -J4, DT5Y (1988-00) DT5Y (1998-02) DT4K1 (2001)		

REF	OEM		
REC09283-25035	09283-25035	25 x 40 x 7 mm	
	DT15C (1989-97) DT9.9K, DT15K-G-Y (1986-00) DT9.9, DT15K1-K4 (2001-04)		

REF	OEM		
REC09283-25075	09283-25075	25 x 52 x 7 mm	
	DT9.9K, DT15K-G-Y (1986-00) DT9.9, DT15K1-K4 (2001-04)		

REF	OEM		
REC09283-25076	09283-25075	25 x 45 x 5 mm	
	DF4, DF5, DF6 (2002+)		

REF	OEM		
REC09283-30062	09283-30062	30 x 55 x 8 mm	
	DT20, DT25, DT30G-Y (1986-00) DT25, DT30K1-K2 (2001-02) DT40C-W-G-X (1986-99) DT40W K1-K4 (2001-04) DT55, DT65J-X (1988-99) DT75, DT85J-Y (1988-00)		

REF	OEM		
REC09289-12002	09289-12002	12 x 28 x 8 mm	
	DT2, DT2.2 G-Y (1986-00) DT2.2 K1-K5 (2001-05)		

REF	OEM		
REC09289-17004	09289-17004	17 x 30 x 9 mm	
	DT20, DT25, DT30G-Y (1986-00) DT25, DT30K1-K2 (2001-02)		

REF	OEM		
REC09289-17006	09289-17006	17 x 30 x 6 mm	
	DF8A-AR, DF9.9A-AR (2010-12) DF9.9, DF15(R) (2004-12) DF9.9, DF15T-K3 (1996-03) D9.9K, DT15K-G-Y (1986-00) DT9.9, DT15K1-K4 (2001-04) DT15C (1989-97)		

REF	OEM		
REC09289-20009	09289-20009	20 x 34 x 6,5 mm	
	DF20R, DF25, DF25RVZ (2006-11) DF25, DF30Y-K6 (2000-06) DT20, DT25, DT30G-Y (1986-00) DT25, DT30K1-K2 (2001-02) DT25C, DT30C-K-Y (1989-00)		

REF	OEM	
REC09289-22007	09289-22007	21.2 x 35 x 5 mm



 DF40A, DF50A, DF60A (2010+)  
 DF40, DF50X-K10 (1999-10)  
 DT40X-W-G-X (1986-99)  
 DT40C-W-G-X (1986-99)  
 DT40W-K1-K4 (2001-04)  
 DT55, DT65J-X (1988-99)

REF	OEM	
REC09289-12003	09289-12003	13 x 26 x 10 mm



 DF15 (2012)  
 DF9.9, DF15T-K3 (1996-03)  
 DF9.9, DF15(R) (2004-11)  
 DT15C (1989-97)  
 DT9.9, DT15 K1-K4 (2001-04)  
 DT9.9K, DT15K G-Y (1986-00)

REF	OEM	
REC09289-30008	09289-30008	30 x 52 x 10 mm



 DT9.9K, DT15K-G-Y (1986-00)  
 DT9.9, DT15K1-K4 (2001-04)

REF	OEM	
REC93101-22067	09282-22007 09282-22004	22 x 36 x 6 mm



 DT90, DT100 (1990-00)  
 DF40A, DF50A, DF60A (2014+)  
 DF60, DF70 (1998-09)  
 DF70A, DF80A, DF90A (2009-14)

**JUNTA TAPÓN DE DRENAJE**      **O-RING DRAIN CAP**      **GUARNIZIONE TAPPO DRENAGIO**      **JOINT DE VIDANGE**

REF	OEM	
REC09168-10022	09168-10022	10 x 17 x 1.5 mm



 2.5 ---> 225 HP

**CIGÜEÑAL**      **CRANKSHAFT**      **ALBERO MOTORE**      **VILEBREQUIN**

**PARTES DE CIGÜEÑAL**      **CRANKSHAFT PARTS**      **PARTE ALBERO MOTORE**      **PARTIES DE VILEBREQUIN**

REF	OEM	
1 REC12221-94412	12221-94412	
2 REC12231-94413	12231-94413	
3 REC12232-94412	12232-94412	
4 REC12240-94432	12240-94432	

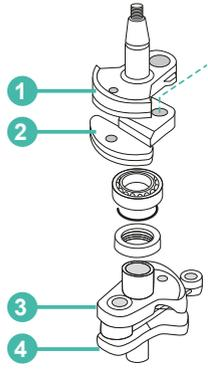

 DT40C-W-G-X (1986-99)  
 DTW-K1-K4 (2001-04)



**RODAMIENTOS DE CIGÜEÑAL**      **CRANKSHAFT BEARINGS**      **CUSCINETTI ALBERO MOTORE**      **ROULEMENTS VILEBREQUIN**

REF	OEM	
REC09262-25078	09262-25078	25 x 25 x 15 mm



 DT9.9K, DT15K-G-Y (1986-00)  
 DT9.9, DT15K1-K4 (2001-04)

REF	OEM	
REC09269-30012	09269-30012	30 x 72 x 19 mm



 DT40X-W-G-X (1986-99)  
 DT40WK1-K4 (2001-04)  
 DT55, DT65J-X (1988-99)  
 DT75, DT85J-Y (1988-00)

REF	OEM	
REC09262-30055	09262-30055	30 x 72 x 19 mm

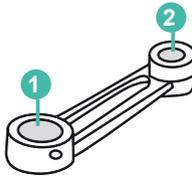

 DT20, DT25, DT30G-Y (1986-00)  
 DT25, DT30K1-K2 (2001-04)  
 DT75, DT85J-Y (1988-00)

BIELAS	CONNECTING ROD	BIELLA	BIELLE																
<table border="1"> <thead> <tr> <th>REF</th> <th>OEM</th> </tr> </thead> <tbody> <tr> <td>REC12161-93902</td> <td>12161-93902</td> </tr> <tr> <td></td> <td>DT9.9K, DT15K-G-Y (1986-00) DT9.9, DT15K1-K4 (2001-04) DT15C (1989-97)</td> </tr> </tbody> </table> 	REF	OEM	REC12161-93902	12161-93902		DT9.9K, DT15K-G-Y (1986-00) DT9.9, DT15K1-K4 (2001-04) DT15C (1989-97)		<table border="1"> <thead> <tr> <th>REF</th> <th>OEM</th> </tr> </thead> <tbody> <tr> <td>REC12161-94400</td> <td>12161-94400</td> </tr> <tr> <td></td> <td>DT40C-W-G-Y (1986-99) DT40W K1-K4 (2001-04) DT55, DT65J-X (1988-99)</td> </tr> </tbody> </table> 	REF	OEM	REC12161-94400	12161-94400		DT40C-W-G-Y (1986-99) DT40W K1-K4 (2001-04) DT55, DT65J-X (1988-99)					
REF	OEM																		
REC12161-93902	12161-93902																		
	DT9.9K, DT15K-G-Y (1986-00) DT9.9, DT15K1-K4 (2001-04) DT15C (1989-97)																		
REF	OEM																		
REC12161-94400	12161-94400																		
	DT40C-W-G-Y (1986-99) DT40W K1-K4 (2001-04) DT55, DT65J-X (1988-99)																		
<table border="1"> <thead> <tr> <th>REF</th> <th>OEM</th> </tr> </thead> <tbody> <tr> <td>REC12161-96300</td> <td>12161-96300</td> </tr> <tr> <td></td> <td>DT20, DT25, DT30G-Y (1986-00) DT25, DT30K1-K2 (2001-02)</td> </tr> </tbody> </table> 	REF	OEM	REC12161-96300	12161-96300		DT20, DT25, DT30G-Y (1986-00) DT25, DT30K1-K2 (2001-02)													
REF	OEM																		
REC12161-96300	12161-96300																		
	DT20, DT25, DT30G-Y (1986-00) DT25, DT30K1-K2 (2001-02)																		
ARANDELAS DE BIELA	CONNECTING ROD, THRUST WASHER	RONDELLE BIELLA	RONDELLE DE BIELLE																
<table border="1"> <thead> <tr> <th>REF</th> <th>OEM</th> </tr> </thead> <tbody> <tr> <td>REC09160-27008</td> <td>09160-27008</td> </tr> <tr> <td></td> <td>DT35 (1987-89) DT40 (1986-98) DT55 (1985-97) DT65 (1985-97)</td> </tr> </tbody> </table> 	REF	OEM	REC09160-27008	09160-27008		DT35 (1987-89) DT40 (1986-98) DT55 (1985-97) DT65 (1985-97)		<table border="1"> <thead> <tr> <th>REF</th> <th>OEM</th> </tr> </thead> <tbody> <tr> <td>REC09181-24001</td> <td>09181-24001</td> </tr> <tr> <td></td> <td>DT20, DT25, DT30G-Y (1986-00) DT25, DT30K1-K2 (2001-02)</td> </tr> </tbody> </table> 	REF	OEM	REC09181-24001	09181-24001		DT20, DT25, DT30G-Y (1986-00) DT25, DT30K1-K2 (2001-02)					
REF	OEM																		
REC09160-27008	09160-27008																		
	DT35 (1987-89) DT40 (1986-98) DT55 (1985-97) DT65 (1985-97)																		
REF	OEM																		
REC09181-24001	09181-24001																		
	DT20, DT25, DT30G-Y (1986-00) DT25, DT30K1-K2 (2001-02)																		
<table border="1"> <thead> <tr> <th>REF</th> <th>OEM</th> </tr> </thead> <tbody> <tr> <td>REC09160-20052</td> <td>09160-20052</td> </tr> <tr> <td></td> <td>DT15C (1989-97) DT9.9, DT15K1-K4 (2001-04) DT9.9K, DT15K-G-Y (1986-00)</td> </tr> </tbody> </table> 	REF	OEM	REC09160-20052	09160-20052		DT15C (1989-97) DT9.9, DT15K1-K4 (2001-04) DT9.9K, DT15K-G-Y (1986-00)													
REF	OEM																		
REC09160-20052	09160-20052																		
	DT15C (1989-97) DT9.9, DT15K1-K4 (2001-04) DT9.9K, DT15K-G-Y (1986-00)																		
COJINETES DE BIELA	CONNECTING ROD, BEARINGS	CUSCINETTI BIELLA	ROULEMENTS DE BIELLE																
<table border="1"> <thead> <tr> <th>1</th> <th>REF</th> <th>OEM</th> </tr> </thead> <tbody> <tr> <td></td> <td>REC09263-14022</td> <td>09263-14022</td> </tr> <tr> <td></td> <td>DT9.9K, DT15K G-Y (1986-00) DT9.9, DT15K1-K4 (2001-04)</td> </tr> </tbody> </table> 	1	REF	OEM		REC09263-14022	09263-14022		DT9.9K, DT15K G-Y (1986-00) DT9.9, DT15K1-K4 (2001-04)		<table border="1"> <thead> <tr> <th>2</th> <th>REF</th> <th>OEM</th> </tr> </thead> <tbody> <tr> <td></td> <td>REC09263-14022</td> <td>09263-14022</td> </tr> <tr> <td></td> <td>DT9.9K, DT15K G-Y (1986-00) DT9.9, DT15K1-K4 (2001-04)</td> </tr> </tbody> </table> 	2	REF	OEM		REC09263-14022	09263-14022		DT9.9K, DT15K G-Y (1986-00) DT9.9, DT15K1-K4 (2001-04)	
1	REF	OEM																	
	REC09263-14022	09263-14022																	
	DT9.9K, DT15K G-Y (1986-00) DT9.9, DT15K1-K4 (2001-04)																		
2	REF	OEM																	
	REC09263-14022	09263-14022																	
	DT9.9K, DT15K G-Y (1986-00) DT9.9, DT15K1-K4 (2001-04)																		
<table border="1"> <thead> <tr> <th>1</th> <th>REF</th> <th>OEM</th> </tr> </thead> <tbody> <tr> <td></td> <td>REC09263-18016</td> <td>09263-14022</td> </tr> <tr> <td></td> <td>DT25 (1983-88) DT30 (1983-88)</td> </tr> </tbody> </table> 	1	REF	OEM		REC09263-18016	09263-14022		DT25 (1983-88) DT30 (1983-88)		<table border="1"> <thead> <tr> <th>2</th> <th>REF</th> <th>OEM</th> </tr> </thead> <tbody> <tr> <td></td> <td>REC09263-20051</td> <td>09263-20051</td> </tr> <tr> <td></td> <td>DT15C (1989-97) DT9.9, DT15K1-K4 (2001-04) DT9.9K, DT15K-G-Y (1986-00)</td> </tr> </tbody> </table> 	2	REF	OEM		REC09263-20051	09263-20051		DT15C (1989-97) DT9.9, DT15K1-K4 (2001-04) DT9.9K, DT15K-G-Y (1986-00)	
1	REF	OEM																	
	REC09263-18016	09263-14022																	
	DT25 (1983-88) DT30 (1983-88)																		
2	REF	OEM																	
	REC09263-20051	09263-20051																	
	DT15C (1989-97) DT9.9, DT15K1-K4 (2001-04) DT9.9K, DT15K-G-Y (1986-00)																		
<table border="1"> <thead> <tr> <th>1</th> <th>REF</th> <th>OEM</th> </tr> </thead> <tbody> <tr> <td></td> <td>REC09263-20072</td> <td>09263-20072</td> </tr> <tr> <td></td> <td>DT40C-W-G-X (1986-99) DT40W K1-K4 (2001-04) DT55, DT65J-X (1988-99) DT90, DT100L-Y (1990-00)</td> </tr> </tbody> </table> 	1	REF	OEM		REC09263-20072	09263-20072		DT40C-W-G-X (1986-99) DT40W K1-K4 (2001-04) DT55, DT65J-X (1988-99) DT90, DT100L-Y (1990-00)		<table border="1"> <thead> <tr> <th>2</th> <th>REF</th> <th>OEM</th> </tr> </thead> <tbody> <tr> <td></td> <td>REC09263-27005</td> <td>09263-27005</td> </tr> <tr> <td></td> <td>DT40C-W-G-X (1986-99) DT40W K1-K4 (2001-04) DT55, DT65J-X (1988-99)</td> </tr> </tbody> </table> 	2	REF	OEM		REC09263-27005	09263-27005		DT40C-W-G-X (1986-99) DT40W K1-K4 (2001-04) DT55, DT65J-X (1988-99)	
1	REF	OEM																	
	REC09263-20072	09263-20072																	
	DT40C-W-G-X (1986-99) DT40W K1-K4 (2001-04) DT55, DT65J-X (1988-99) DT90, DT100L-Y (1990-00)																		
2	REF	OEM																	
	REC09263-27005	09263-27005																	
	DT40C-W-G-X (1986-99) DT40W K1-K4 (2001-04) DT55, DT65J-X (1988-99)																		
<table border="1"> <thead> <tr> <th>1</th> <th>REF</th> <th>OEM</th> </tr> </thead> <tbody> <tr> <td></td> <td>REC09263-24018</td> <td>09263-24018</td> </tr> <tr> <td></td> <td>DF20 (1986-88) DT25 (1983-88) DT30 (1983-85) DT40 (1984-85) DT50 (1984+)</td> </tr> </tbody> </table> 	1	REF	OEM		REC09263-24018	09263-24018		DF20 (1986-88) DT25 (1983-88) DT30 (1983-85) DT40 (1984-85) DT50 (1984+)											
1	REF	OEM																	
	REC09263-24018	09263-24018																	
	DF20 (1986-88) DT25 (1983-88) DT30 (1983-85) DT40 (1984-85) DT50 (1984+)																		



PISTONES

PISTONS

PISTONI

PISTONS

KITS DE PISTONES

PISTON KITS

KIT PISTONE

KIT PISTON

	STD	
	REF	OEM
	REC12110-93130K	12110-93130
	REC12140-93121	12140-93121
	REC09263-14022	09263-14014



DT9.9, DT15K-G-Y (1986-00)  
DT9.9, DT15K1-K4 (2001-04)

	STD	
	REF	OEM
	REC12110-94400K	12110-94400K
	REC12140-94400	12140-94400
	REC09263-20072	09263-20072



DT40C-W-G-X (1986-99)  
DT40W-K1-K4 (2001-04)

	STD	
	REF	OEM
	REC12110-94350K	12110-94350



DT35 (1980-82)  
DT40 (1980-82)

GUÍA  
CORREAS DE  
DISTRIBUCIÓN

GUIDE  
TIMING BELT

GUIDA  
CINGHIE  
DISTRIBUZIONE

GUIDE DES  
COURROIES DE  
DISTRIBUTION

			REF		OEM	
	DF8A, DF8AR, DF9.9A, DF9.9AR	2010+	66	REC12761-99J00	12761-99J00	
	DF15	2012	69	REC12761-93ELO	12761-93ELO	
	DF9.9, DF15T-K3	1996-03	69	REC12761-93ELO	12761-93ELO	
	DF9.9, DF15 R	2004-11	69	REC12761-93ELO	12761-93ELO	
	DF9.9B, DF15A	2013+	69	REC12761-93ELO	12761-93ELO	
	DF60, DF70 W-K9	1998-09	89	REC12761-72F00	12761-72F00	



# SISTEMA DE ESCAPE Y ADMISIÓN EXHAUST & INTAKE SYSTEM

# SISTEMA DI SCARICO E ASPIRAZIONE SYSTÈME D'ÉCHAPPEMENT ET D'ADMISSION

4T  
STROKES

SISTEMA DE ESCAPE 4 TIEMPOS	EXHAUST SYSTEM 4 STROKES	SISTEMA SCARICO 4 TEMPI	SYSTÈME D'ÉCHAPPEMENT 4 TEMPS
<b>JUNTAS COLECTOR</b>	<b>GASKET, COLLECTOR</b>	<b>GUARNIZIONE COLLETTORE</b>	<b>JOINT DE COLLECTEUR</b>

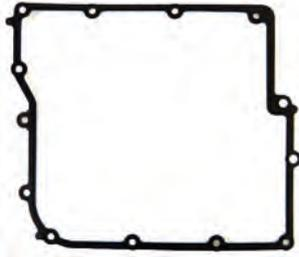
REF	OEM	
REC13147-98J00	13147-98J00	
 DF300AP (2012) DF300T/Z (2007-11)		

4T  
STROKES

JUNTAS CARTER	OIL PAN GASKET	GUARNIZIONE CARTER	JOINTS DE CARTER
---------------	----------------	--------------------	------------------

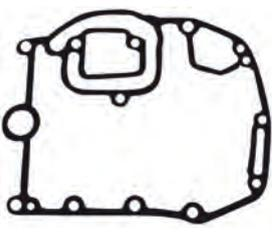
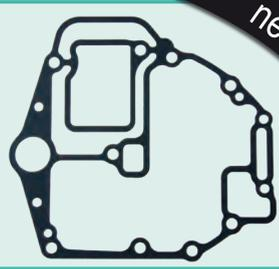
REF	OEM		
REC11489-90J00	11489-90J00		 <span style="float: right;">new</span>
 DF90, DF100, DF115 K1-K11 (2001-11) DF140 (2002-12) DF115WT, DF140WT-K3 (2003) DF100A, DF115A 7, DF140 (2013+)			
REF	OEM		
REC11489-87L00	11489-87L00	 DF70A, DF80A, DF90A, DF100B (2009+)	

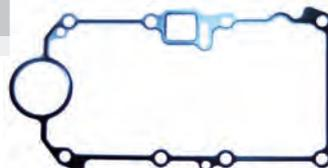
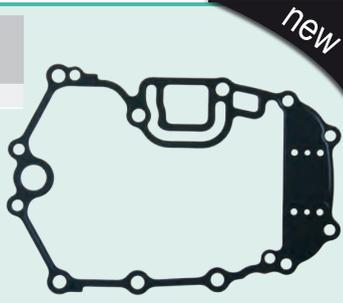
REF	OEM		
REC11489-93E11	11489-93E10		 <span style="float: right;">new</span>
 DF9.9, DF15 (R) (2004-11) DF15 (2012)			

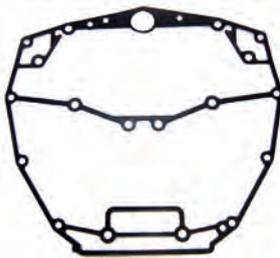
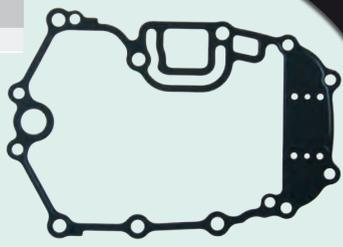
REF	OEM		
REC11489-93J00	11489-93J00		 <span style="float: right;">new</span>
 DF200, DF225, DF250 (2004+) DF300AP (2012) DF300T-Z (2007-11)			
REF	OEM		
REC11489-87J00	11489-87J00	 DF40, DF50 (1999-10)	

4T  
STROKES

JUNTA MÚLTIPLE DE ESCAPE	MULTI EXHAUST GASKET	GUARNIZIONE SCARICO MULTIPLO	JOINT DE PIPE D'ÉCHAPPEMENT
--------------------------	----------------------	------------------------------	-----------------------------

REF	OEM	
REC11542-87L00	11542-87L00	 <span style="float: right;">new</span>
 DF70A, DF80A, DF90A, DF100B (2009+)		

SUZUKI

RECAMBIOS MARINOS

# SISTEMA DE ADMISION 4 TIEMPOS

# INTAKE SYSTEM 4 STROKES

# SISTEMA ASPIRAZIONE 4 TEMPI

# SYSTEME D'ADMISSION 4 TEMPS

4T  
STROKES

## JUNTAS COLECTOR

## GASKET, COLLECTOR

## GUARNIZIONE COLLETTORE

## JOINT DE COLLECTEUR

REF	OEM
REC13122-95J00	13122-95J00

DF20R, DF25, DF25R V2 (2006 -11)



REF	OEM
REC13119-93J00	13119-93J00

DF200, DF225, DF250 (2004+)



4T  
STROKES

## JUNTA TAPA ESCAPE

## GASKET EXHAUST COVER

## GUARNIZIONE COPERCHIO SCARICO

## JOINT DE COUVERCLE D'ECHAPPEMENT

REF	OEM
REC14212-93J00	14212-93J00

DF200, DF225, DF250 (2004+)  
DF300AP (2012)  
DF300T/Z (2007-11)



REF	OEM
REC52331-87L00	52331-87L00

DF70A, DF80A, DF90A (2009+)



REF	OEM	
REC14152-93J00	14152-93J00	BABOR   PORT   BABORDO   GAUCHE
REC14151-93J00	14151-93J00	ESTRIBOR   STD   TRIBORDO   DROIT

DF200, DF225, DF250 (2004+)  
DF300AP (2015)  
DF300T/Z (2007-11)



REC14151-93J00



REC14152-93J00

REF	OEM
REC14151-87L00	14151-87L00

DF70A, DF80A, DF90A, DF100B (2009+)

new



**SISTEMA DE ESCAPE 2 TIEMPOS**

**EXHAUST SYSTEM 2 STROKES**

**SISTEMA SCARICO 2 TEMPI**

**SYSTÈME D'ÉCHAPPEMENT 2 TEMPS**

2T  
STROKES

**JUNTAS DE ESCAPE**

**GASKET, EXHAUST**

**GUARNIZIONE SCARICO**

**JOINTS D'ÉCHAPPEMENT**

REF	OEM
REC14212-94413	14212-94412
	DT40C-W-G-X (1986-99)



REF	OEM
REC52113-93910	52113-93901
	DT9.9, DT15 K1-K4 (2001-04) DT9.9K, DT15K-G-Y (1986-00)

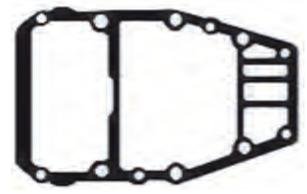

REF	OEM
REC52113-96330	52113-96304
	DT20, DT25, DT30G-Y (1986-00) DT25, DT30K1-K4 (2001-02)

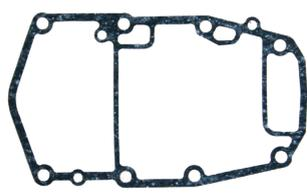

REF	OEM
REC14151-96311	14151-96310
	DT20, DT25, DT30G-Y (1986-00) DT25, DT30 K1-K2 (2001-02)

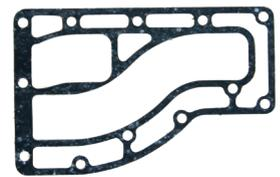

REF	OEM
REC14151-93912	14151-93901
	DT9.9, DT15 K1-K4 (2001-04) DT9.9K, DT15K-G-Y (1986-00)

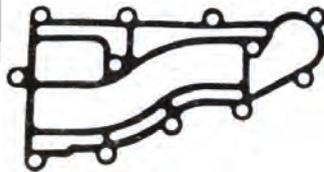

REF	OEM
REC11434-94411	11434-94411
	DT40C-W-G-X (1986-99) DT40W K1-K4 (2001-04)

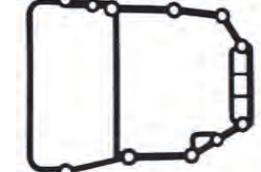

REF	OEM
REC14151-94411	14151-94412
	DT40C-W-G-X (1986-99) DT40W K1-K4 (2001-04)

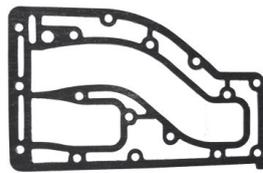

2T  
STROKES

**JUNTAS TAPA DE ESCAPE**

**GASKET, EXHAUST COVER**

**GUARNIZIONE COPERTURA SCARICO**

**JOINTS DE PLAQUE D'ÉCHAPPEMENT**

REF	OEM
REC14141-93952-0EP	14141-93952-0EP
	DT9.9, DT15 K1-K4 (2001-04) DT9.9K, DT15K G-Y (1986-00)

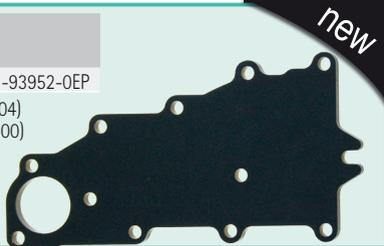

2T  
STROKES

**JUNTAS TUBO DE ESCAPE**

**GASKET, EXHAUST TUBE**

**GUARNIZIONE TUBO DI SCARICO**

**JOINT TUBE D'ÉCHAPPEMENT**

REF	OEM
REC14212-91L00	14212-91L00 14212-96310
	DT20, DT25, DT30 G-Y (1986-00) DT25, DT30 K1-K2 (2001-02)

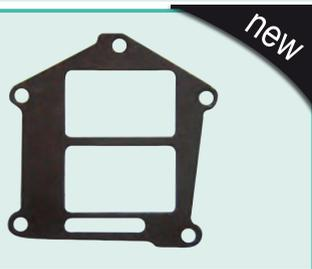

# UNIDADES DE TRANSMISIÓN UNIT DRIVES & COMPONENTS

# UNITÀ DI TRASMISSIONE EMBASES ET PIÈCES

DESPIECE COLAS  
4 TIEMPOS

GEAR CASE PARTS  
4 STROKES

PARTI PIEDI  
DE 4 TEMPI

PIÈCES D'EMBASES  
4 TEMPS

4T DF4, DF5, DF6  
STROKES

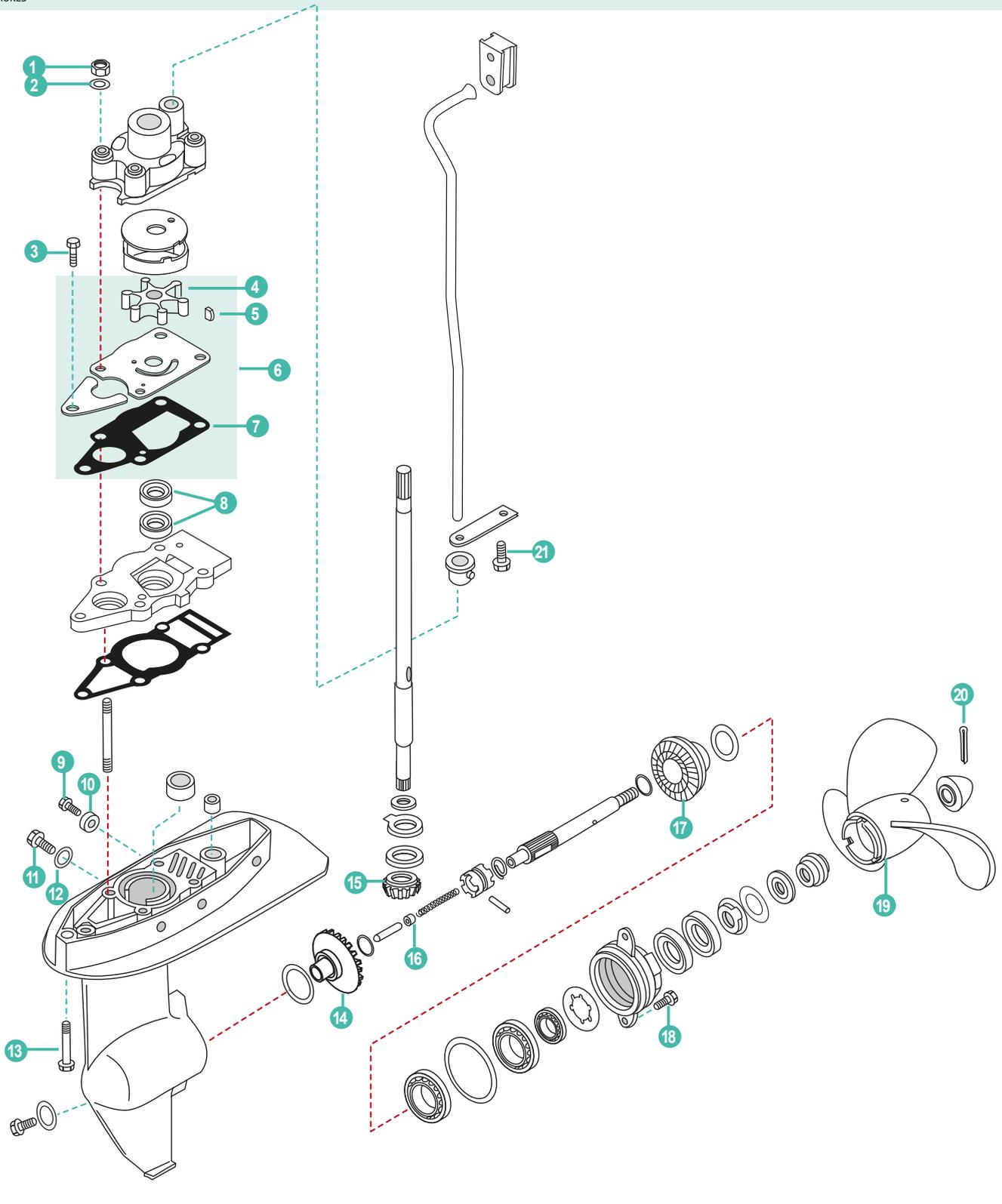

SUZUKI

RECAMBIOS  
MARINOS

	REF	OEM				
1	PAGB/T6170-M6	29141-93J00	TUERCA HEXÁGONO M6	NUT HEXAGON M6	DADO ESAGONALE M6	ECROU HEXAGONAL M6
2	PAGB/T848-6	09160-06082	ARANDELA	WASHER	RONDELLA	RONDELLE
3	PAGB/T5283-M6X25	09116-06229	TORNILLO HEXAGONAL M6x25	HEXAGON BOLT M6x25	BULLONE ESAGONALE M6x25	BOULON HEXAGONAL M6x25
4	REC17461-98503	17461-985M0	IMPULSOR	IMPELLER	GIRANTE	TURBINE
5	REC09420-03002	09420-03002	CHAVETA IMPELLER	KEY	CHIUSURA	CLAVETTE TURBINE
6	REC17400-98661	17400-98661	KIT BOMBA AGUA	WATER PUMP KIT	KIT POMPA ACQUA	KIT POMPE À EAU
7	REC17472-91J00	17472-91J00	JUNTA DE LA BOMBA	GASKET PUMPCASE	GUARNIZIONE POMPA	JOINT DE POMPE
8	REC09282-10008	09282-10008	RETÉN ACEITE	OIL SEAL	PARAOLIO	JOINT SPI
9	PAGB/T5783-M6X14	09103-06281	TORNILLO HEXAGONAL M6x14	HEXAGON BOLT M6x14	BULLONE ESAGONALE M6x14	BOULON HEXAGONAL M6x14
10	CM55321-87J00	55321-87J00	ÁNODO	ANODE	ANODO	ANODE
11	REC09248-10008	09248-10008	TORNILLO 10x7,5	SCREW 10x7,5	VITE 10x7,5	VIS 10x7,5
12	REC09168-10022	09168-10022	ARANDELA TAPÓN	CAP, O-RING	RONDELLA TAPPO	JOINT DE VIDANGE
13	PAGB/T5787-1986	09116-08156	TORNILLO HEXAGONAL M8x50	HEXAGON BOLT M8x50	BULLONE ESAGONALE M8x50	BOULON HEXAGONAL M8x50
14	REC57510-91J00	57510-91J00	PIÑÓN MARCHA AVANTE	FORWARD GEAR	INGRANAGGIO MARCIA AVANTI	PIGNON MARCHE AV
15	REC57311-98600	57311-91J00	PIÑÓN ATAQUE	INITIATIVE GEAR	PIGNONE	PIGNON D'ATTAQUE
16	REC57632-97L00	57632-98501	PIN SELECTOR	SELECTOR PIN	PIN SELETTORE	CLAVETTE
17	REC57521-91J00	57521-91J00	PIÑÓN MARCHA ATRÁS	RESERVE GEAR	PIGNONE MARCIA INDIETRO	PIGNON MARCHE AR
18	PAGB/T5783-M6X16	09116-06225	TORNILLO HEXAGONAL M6x16	HEXAGON BOLT M6x16	BULLONE ESAGONALE M6x16	BOULON HEXAGONAL M6x16
19	SOL4011-079-075	58110-91JN0-019	HÉLICE AMITA 3 7.9x6.75	PROPELLER AMITA 3 7.9x6.75	ELICA AMITA 3 7.9x6.75	HELICE AMITA 3 7.9x6.75
20	REC91490-40030	09204-03003	PASADOR	PIN	FERMO	GOUPILLE
21	PAGB/T5783-M6X16	09116-06225	TORNILLO HEXAGONAL M6x16	HEXAGON BOLT M6x16	BULLONE ESAGONALE M6x16	BOULON HEXAGONAL M6x16



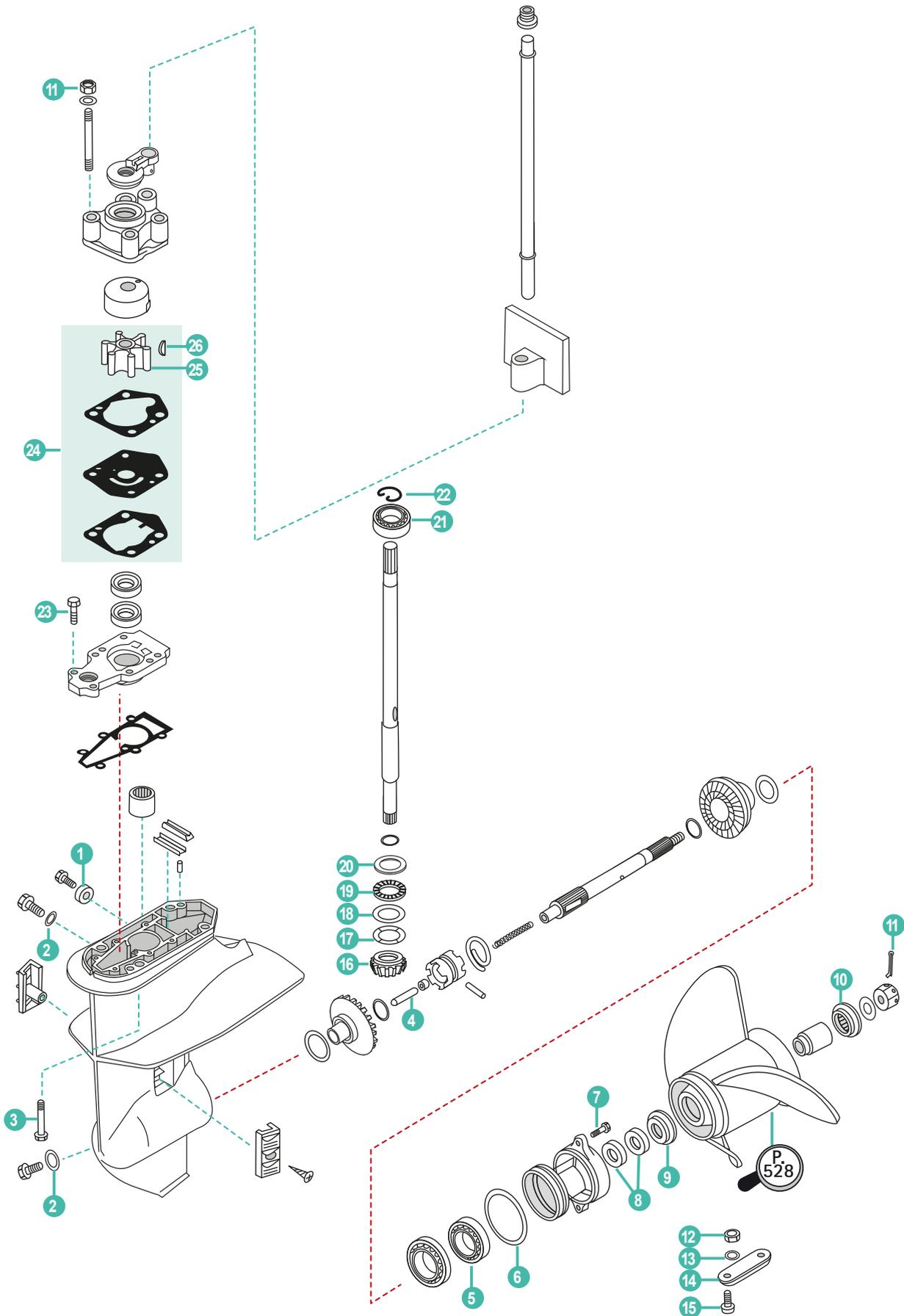

	REF	OEM				
1	CM55321-87J00	55321-87J01	ÁNODO	ANODE	ANODO	ANODE
2	REC59178-97J00	59178-97J00	JUNTA DRENAJE COLA	DRAIN PLUG GASKET	GUARNIZIONE DRENAGGIO	JOINT DE VIDANGE
3	PAGB/T5783-M8X30	09116-08151	PERNO M8x30	BOLT M8x30	BULLONE M8x30	BOULON M8x30
4	REC57631-93901	57631-93901	VARILLA SELECTOR	ROD PUSH	ASTA SELETTORE	CLAVETTE
5	REC08110-60050	08110-60050	RODAMIENTO	BEARING	CUSCINETTO	ROULEMENT
6	REC09280-57002	09280-57002	ARO TORICO	O-RING	O-RING	JOINT TORIQUE
7	PAGB/T5787-M6X20	09116-06227	TORNILLO	BOLT, FLANGE	VITE	VIS DE BRIDE
8	REC09289-17006	09289-17L02	RETÉN ACEITE	OIL SEAL	PARAOLIO	JOINT SPI
9	REC57632-94J00	57632-94J00	SEPARADOR HELICE	PROPELLER WASHER	DISTANZIALE ELICA	RONDELLE HÉLICE
10	REC57633-93901	57633-93901	SEPARADOR	SPACER	DISTANZIALE	ENTRETOISE
11	REC09204-02004	09204-02004	PIN BLOQUEADOR	COTTER PIN	COPPIGLIA	GOUPILLE
12	PAGB/T6170-M6	29141-93J00	TUERCA HEXÁGONO M6	NUT HEXAGON M6	DADO ESAGONALE M6	ECROU HEXAGONAL M6
13	PAGB/T93-6	29162-93J00	ARANDELA MUELLE 6	WASHER SPRING 6	RONDELLA MOLLA 6	RESSORT 6
14	CM55300-95500	55300-95500	ÁNODO	ANODE	ANODO	ANODE
15	PAGB/T820-M6X20	09126-06006	TORNILLO M6x20	SCREW M6x20	VITE M6x20	VIS M6x20
16	REC57311-99J10	57311-99J10	PIÑÓN ATAQUE	INITIATIVE GEAR	PIGNONE	PIGNON D'ATTAQUE
	REC09160-20042	09160-20042	GRUESO 1.10	SHIM 1.10	SPESSORE 1.10	CALE 1.10
17	REC09160-20043	09160-20043	GRUESO 1.20	SHIM 1.20	SPESSORE 1.20	CALE 1.20
	REC09160-20044	09160-20044	GRUESO 1.30	SHIM 1.30	SPESSORE 1.30	CALE 1.30
18	REC09160-20027	09160-20027	ARANDELA PIÑÓN	WASHER GEAR	RONDELLA PIGNONE	RONDELLE DE PIGNON
19	REC09263-20L04	09263-20024	RODAMIENTO	BEARING	CUSCINETTO	ROUEMENT
20	REC09160-21009	09160-21009	ARANDELA PIÑÓN	WASHER GEAR	RONDELLA PIGNONE	RONDELLE DE PIGNON
21	REC08110-60020	08110-60020	RODAMIENTO	BEARING	CUSCINETTO	ROULEMENT
22	REC09380-15001	09380-15001	CIRCLIP	CLIP	CERCLIP	CLIPS
23	REC09116-06121	09116-06229	TORNILLO	BOLT	VITE	VIS
24	REC17400-99J01	17400-99J01	KIT BOMBA	PUMP KIT	KIT POMPA	KIT POMPA À EAU
25	REC17461-93903	17461-939M0	IMPULSOR	IMPELLER	GIRANTE	TURBINE
26	REC09420-03005	09420-03009	CHAVETA	KEY	CHIAVETTA	CLAVETTE



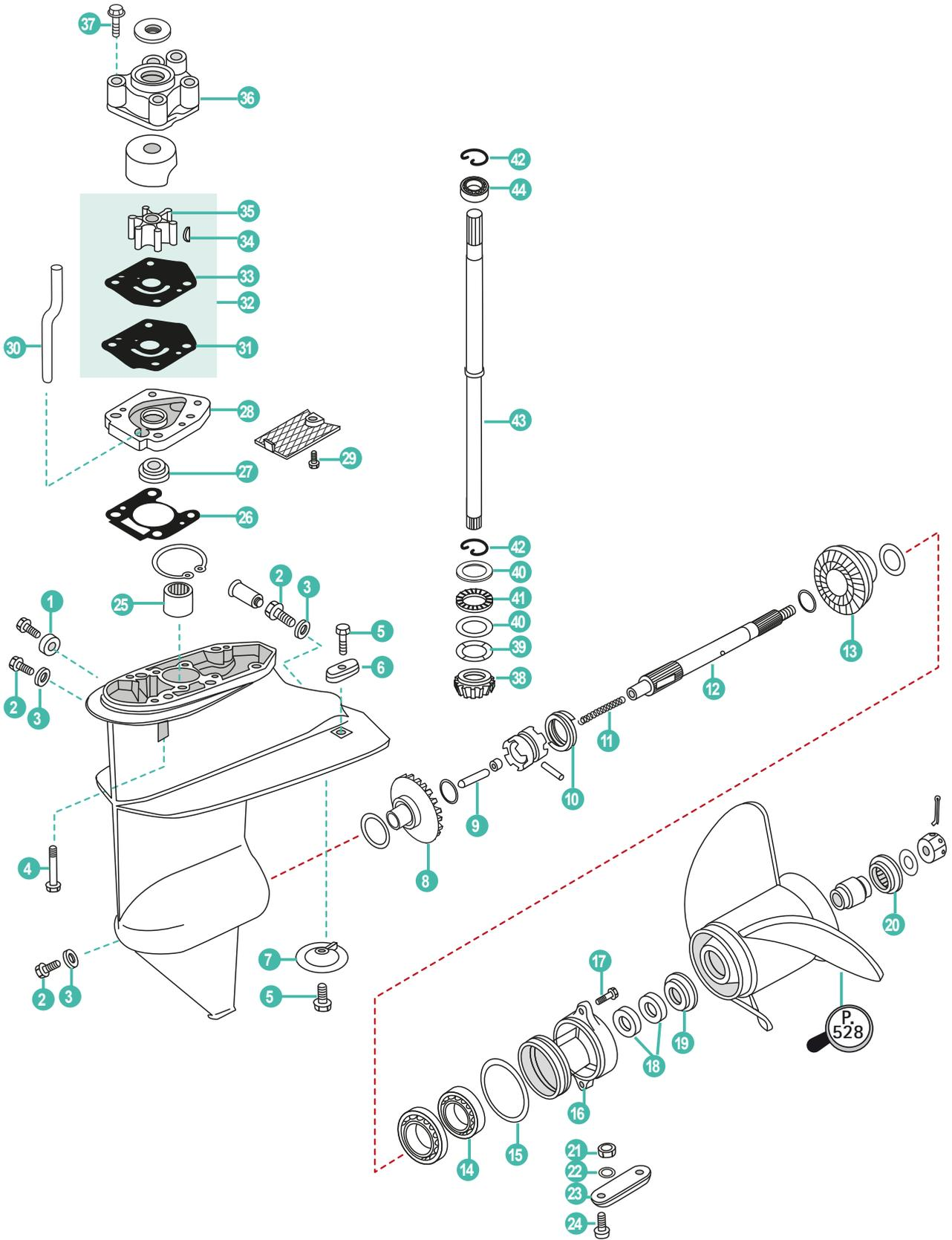

	REF	OEM				
1	CM55321-87J00	55321-87J00	ÁNODO	ANODE	ANODO	ANODE
2	REC09248-10008	09248-10008	TORNILLO 10x7,5	SCREW 10x7,5	VITE 10x7,5	VIS 10x7,5
3	REC09168-10022	09168-10022	ARANDELA TAPÓN	CAP, O-RING	RONDELLA TAPPO	JOINT DE VIDANGE
4	PAGB/T5783-M8X30	09117-08047	TORNILLO M8X30	BOLT M8X30	BULLONE M8X30	BOULON M8X30
5	REC09116-06094	09116-06094	TORNILLO 6x15	SCREW 6x15	VITE 6x15	VIS 6x15
6	CM41811-98500	41811-98500	ÁNODO	ANODE	ANODO	ANODE
7	CM55321-93900	55321-93900	ÁNODO	ANODE	ANODO	ANODE
8	REC57510-93910	57510-93910	PIÑÓN MARCHA AVANTE	FORWARD GEAR	INGRANAGGIO MARCIA AVANTI	PIGNON MARCHE AVANT
9	REC57631-93901	67631-93901	VARILLA SELECTOR	ROD PUSH	ASTA SELETTORE	CLAVETTE
10	REC09440-32008	09440-32008	MUELLE	CLUTCH	MOLLA	RESSORT
11	REC09440-05027	09440-05027	MUELLE SELECTOR	SELECTOR SPRING	MOLLA SELETTORE	RESSORT DE SELECTEUR
12	REC57610-93901	57610-93901	EJE HELICE	PROPELLER SHAFT	ASSE ELICA	ARBRE D'HELICE
13	REC57521-93910	57521-93910	PIÑÓN MARCHA ATRÁS	REVERSER GEAR	INGRANAGGIO MARCIA INDIETRO	PIGNON MARCHE ARRIÈRE
14	REC08110-60050	08110-60050	RODAMIENTO	BEARING	CUSCINETTO	ROULEMENT
15	REC09280-57002	09280-57002	ARO TORICO	O-RING	O-RING	JOINT TORIQUE
16	REC56120-93900	56120-93901-OEP	DIÁBOLO	CARRIER	DIABOLO	DIABOLO
17	PAGB/T5787-M6X20	29116-93J00	TORNILLO	BOLT, FLANGE	VITE	VIS DE BRIDE
18	REC09289-17006	09289-17006	RETÉN ACEITE	OIL SEAL	PARAOLIO	JOINT SPI
19	REC57632-94J00	57632-93902	SEPARADOR HÉLICE	PROPELLER WASHER	DISTANZIALE ELICA	RONDELLE HÉLICE
20	REC57633-93901	57633-93901	SEPARADOR	SPACER	DISTANZIALE	ENTRETOISE
21	PAGB/T6170-M6	29141-93J00	TUERCA HEXÁGONAL M6	HEXAGON NUT M6	DADO ESAGONALE M6	ECROU HEXAGONAL M6
22	PAGB/T93-6	29162-93J00	ARANDELA MUELLE 6	SPRING WASHER 6	RONDELLA MOLLA 6	RESSORT RONDELLE 6
23	CM55300-95500	55300-95500	ÁNODO	ANODE	ANODO	ANODE
24	PAGB/T820-M6X20	09126-06006	TORNILLO M6x20	SCREW M6x20	VITE M6x20	VIS M6x20
25	REC09263-15019	09263-15019	RODAMIENTO	BEARING	CUSCINETTO	ROULEMENT
26	REC17452-93910	17452-93910	JUNTA COLA	DRIVE GASKET	GUARNIZIONE PIEDE	JOINT D'EMBASE
27	REC09289-12003	09289-12003	RETÉN	OIL SEAL	PARAOLIO	JOINT SPI
28	REC17450-93921	17450-93921	CARCASA BOMBA AGUA	PUMP BASE	BASE POMPA ACQUA	CORPS DE POMPE À EAU
29	PAGB/T818-M6X10	09125-06063	TORNILLO M6x10	BOLT M6x10	BULLONE M6x10	BOULON M6x10
30	REC17453-93901	17453-93900	TUBO VACIADO DE AGUA	WATER TUBE	TUBO ACQUA	TUBE VIDANGE D'EAU
31	REC17472-93911	17472-93911	JUNTA BOMBA AGUA	WATER PUMP GASKET	GUARNIZIONE POMPA ACQUA	JOINT DE POMPE À EAU
32	REC17400-93951	17400-93951	KIT BOMBA AGUA	WATER PUMP SERVICE KIT	KIT POMPA ACQUA	KIT POMPE À EAU
33	REC17471-93902	17471-93902	BASE BOMBA AGUA	WATER PUMP PLATE	COPERCHIO GIRANTE	BASE DE POMPE À EAU
34	REC17462-93990	17462-93990	CHAVETA	KEY	CHIAVETTA	CLAVETTE
35	REC17461-93903	17461-93903	IMPULSOR	IMPELLER	GIRANTE	TURBINE
36	REC17411-93901	17411-93901	CUERPO BOMBA AGUA	HOUSING WATER PUMP	CORPO POMPA ACQUA	CORPS DE POMPE À EAU
37	PAGB/T5783-M8X55	09116-08117	TORNILLO HEXAGONAL M8x55	BOLT HEXAGON M8x55	BULLONE ESAGONALE M8x55	VIS HEXAGONAL M8x55
38	REC57311-93910	57311-93910	PIÑÓN ATAQUE	INITIATIVE GEAR	PIGNONE ATTACCO	PIGNON D'ATAQUE
	REC09160-20041	09160-20041	GRUESO 1.00	SHIM 1.00	SPESSORE 1.00	CALE 1.00
39	REC09160-20042	09160-20042	GRUESO 1.10	SHIM 1.10	SPESSORE 1.10	CALE 1.10
	REC09160-20043	09160-20043	GRUESO 1.20	SHIM 1.20	SPESSORE 1.20	CALE 1.20
	REC09160-20044	09160-20044	GRUESO 1.30	SHIM 1.30	SPESSORE 1.30	CALE 1.30
40	REC09160-21009	09160-21009	ARANDELA PIÑÓN	WASHER GEAR	RONDELLA PIGNONE	RONDELLE DE PIGNON
41	REC09263-20L04	09263-20L04	RODAMIENTO	BEARING	CUSCINETTO	ROULEMENT
42	REC09380-15001	09380-15001	CIRCLIP	CLIP	CERCLIP	CLIPS
43	REC57100-93902	57100-93902	EJE VERTICAL	DRIVE SHAFT	ASSE VERTICALE	ARBRE DE TRANSMISSION
44	REC08110-60020	08110-60020	RODAMIENTO	BEARING	CUSCINETTO	ROULEMENT



4T DF9.9B, DF15A, DF20A  
STROKES

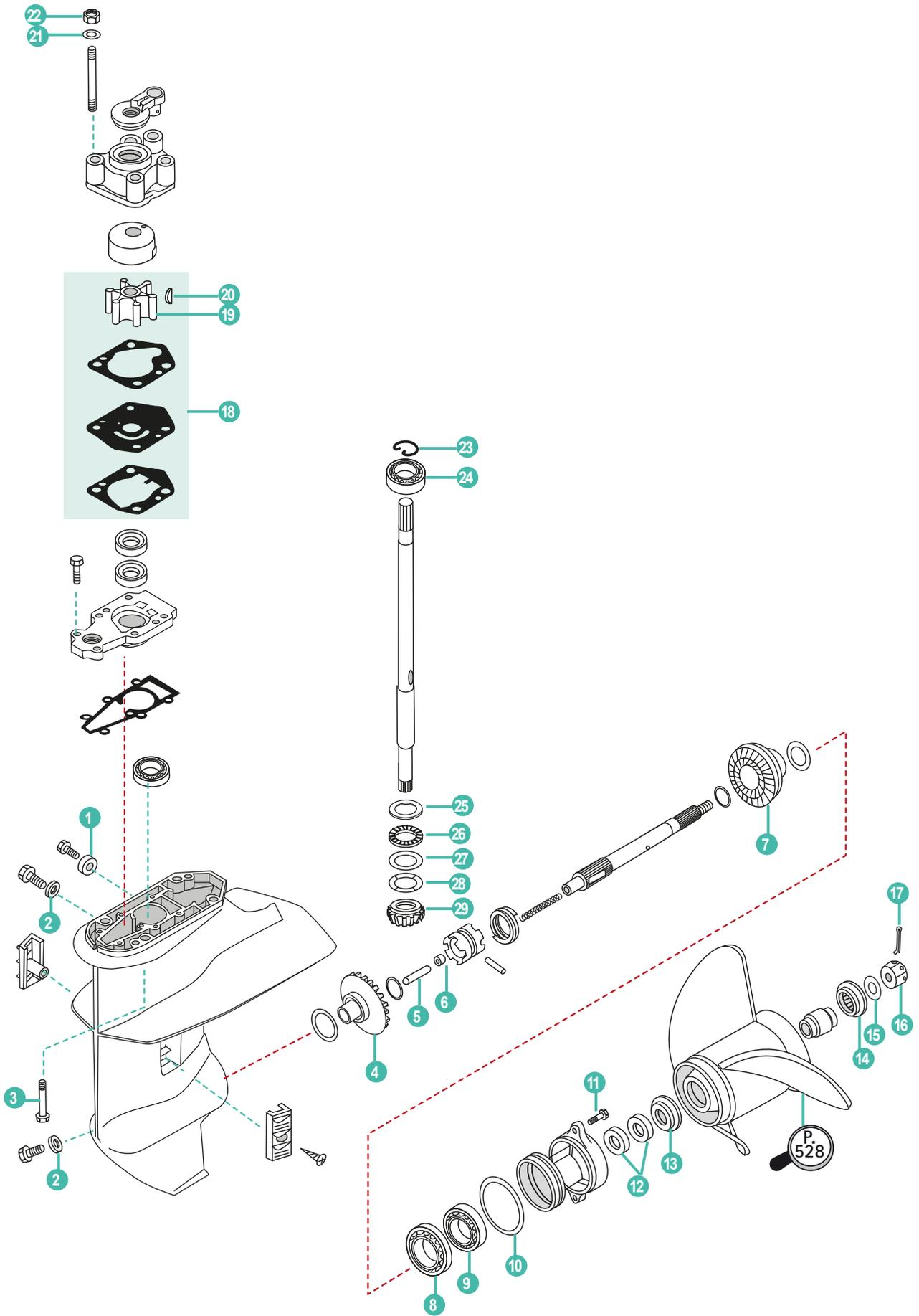



	REF	OEM				
1	CM55321-87J00	55321-87J01	ÁNODO	ANODE	ANODO	ANODE
2	REC59178-97J00	59178-97J00	JUNTA DRENAJE COLA	DRAIN PLUG GASKET	GUARNIZIONE DRENAGGIO	JOINT DE VIDANGE
3	PAGB/T5783-M8X30	09116-08151	TORNILLO M8x30	BOLT M8x30	BULLONE M8x30	BOULON M8x30
4	REC57510-99J11	57510-99J10	PIÑÓN MARCHA AVANTE	POSITIVE GEAR	PIGNONE MARCIA AVANTI	PIGNON MARCHE AVANT
5	REC57631-93901	57631-93901	VARILLA SELECTOR	ROD PUSH	ASTA SELETTORE	CLAVETTE
6	REC57632-97L00	57632-97L00	PIN SELECTOR	SELECTOR PIN	PIN SELETTORE	CLAVETTE
7	REC57521-99J10	57521-99J10	PIÑÓN MARCHA ATRÁS	REVERSE GEAR	PIGNONE MARCIA INDIETRO	PIGNON MARCHE ARRIÈRE
8	REC09262-25078	09262-25003	COJINETE CIGÜEÑAL	CRANKSHAFT BEARING	CUSCINETTO ALBERO MOTORE	PALIER DE VILEBREQUIN
9	REC08110-60050	08110-60050	RODAMIENTO	BEARING	CUSCINETTO	ROULEMENT
10	REC09280-57002	09280-57002	ARO TORICO	O-RING	O-RING	JOINT TORIQUE
11	PAGB/T5787-M6X20	09116-06227	TORNILLO	BOLT, FLANGE	VITE	VIS DE BRIDE
12	REC09289-17006	09289-17L02	RETÉN ACEITE	OIL SEAL	PARAOLIO	JOINT SPI
13	REC57632-94J00	57632-94J00	SEPARADOR HELICE TRASERO	PROPELLER WASHER, BACK	DISTANZIALE ELICA, POSTERIORE	RONDELLE HÉLICE, ARRIÈRE
14	REC57633-93901	57633-93901	SEPARADOR HELICE DELANTERO	PROPELLER WASHER, FRONT	DISTANZIALE ELICA, ANTERIORE	RONDELLE HÉLICE, AVANT
15	REC09160-12066	09160-12066	ARANDELA	WASHER	RONDELLA	RONDELLE
16	REC09141-12005	09141-12005	TUERCA HÉLICE	PROPELLER NUT	DADO ELICA	ECROU D'HELICE
17	REC09204-02004	09204-02004	PIN BLOQUEADOR	COTTER PIN	COPPIGLIA	GOUPILLE
18	REC17400-99J01	17400-99J01	KIT BOMBA	PUMP KIT	KIT POMPA	KIT POMPA À EAU
19	REC17461-93903	17461-93903	IMPULSOR	IMPELLER	GIRANTE	TURBINE
20	REC09420-03005	09420-03005	CHAVETA	KEY	CHIAVETTA	CLAVETTE
21	PAGB/T848-6	09160-06082	ARANDELA	WASHER	RONDELLA	RONDELLE
22	PAGB/T6184-2000	29141-93J00	TUERCA M6	NUT M6	DADO M6	ÉCROU M6
23	REC09380-15001	09380-15001	CIRCLIP	CLIP	CERCLIP	CLIPS
24	REC08110-60020	08110-60020	RODAMIENTO	BEARING	CUSCINETTO	ROULEMENT
25	REC09160-21009	09160-21009	ARANDELA PIÑÓN	WASHER GEAR	RONDELLA PIGNONE	RONDELLE DE PIGNON
26	REC09263-20L04	09263-20L04	RODAMIENTO	BEARING	CUSCINETTO	ROULEMENT
27	REC09160-20027	09160-20027	ARANDELA PIÑÓN	WASHER GEAR	RONDELLA PIGNONE	RONDELLE DE PIGNON
	REC09160-20041	09160-20041	GRUESO 1.00	SHIM 1.00	SPESSORE 1.00	CALE 1.00
28	REC09160-20042	09160-20042	GRUESO 1.10	SHIM 1.10	SPESSORE 1.10	CALE 1.10
	REC09160-20043	09160-20043	GRUESO 1.20	SHIM 1.20	SPESSORE 1.20	CALE 1.20
	REC09160-20044	09160-20044	GRUESO 1.30	SHIM 1.30	SPESSORE 1.30	CALE 1.30
29	REC57311-99J10	57311-97J10	PIÑÓN ATAQUE	INITIATIVE GEAR	PIGNONE	PIGNON D'ATTAQUE





	REF	OEM				
1	PAGB/T6170-M6	29141-93J00	TUERCA HEXÁGONO M6	NUT HEXAGON M6	DADO ESAGONALE M6	ECROU HEXAGONAL M6
2	PAGB/T848-6	09160-06082	ARANDELA	WASHER	RONDELLA	RONDELLE
3	REC17413-95J00	17413-95J00	CASQUILLO INOX	SLEEVE WATER PUMP	CAPPUCCIO	INSERT DE POMPE À EAU
4	REC09420-04006	09420-04006	CHAVETA	KEY	CHIAVETTA	CLAVETTE
5	REC17461-96312	17461-96312	IMPULSOR	IMPELLER	GIRANTE	TURBINE
6	REC17416-95J00	17416-95J00	ARO TÓRICO	O-RING	FASCIA TONDA	JOINT TORIQUE
7	REC17400-95J02	17400-95J02	KIT BOMBA DE AGUA	WATER PUMP KIT	KIT POMPA ACQUA	KIT POMPE A EAU
8	REC17471-95J01	17471-95J01	TAPA DEL IMPULSOR	OUTER PLATE CARTRIDGE	COPERCHIO GIRANTE	PLAQUE DE POMPE À EAU
9	REC17472-96303	17472-96303	JUNTA DE LA BOMBA DE AGUA	WATER PUMP, GASKET	GUARNIZIONE POMPA ACQUA	JOINT POMPE À EAU
10	REC09116-06094	09116-06094	TORNILLO 6x15	SCREW 6x15	VITE 6x15	VIS 6x15
11	REC09265-17002	09265-17002	RODAMIENTO	BEARING	CUSCINETTO	ROULEMENT
12	REC09263-20046	09263-20046	RODAMIENTO	BEARING	CUSCINETTO	ROULEMENT
13	PAGB/T5787-M6X30	09116-08122	TORNILLO M6x30	BOLT M6x30	BULLONE M6x30	BOULON M6x30
14	REC09248-10008	09248-10008	TORNILLO 10x7,5	SCREW 10x7,5	VITE 10x7,5	VIS M10x7,5
15	REC09168-10022	09168-10022	ARANDELA TAPÓN	CAP, O-RING	RONDELLA TAPPO	JOINT DE VIDANGE
16	CM55125-96310	55125-96310	ÁNODO	ANODE	ANODO	ANODE
17	REC57510-89J00	57510-89J00	PIÑÓN MARCHA AVANTE	POSITIVE GEAR	PIGNONE MARCIA AVANTI	PIGNON MARCHE AVANT
18	REC09209-08016	09209-08016	VARILLA PRESION ACEITE	ROD PUSH	ASTA PRESSIONE OLIO	CLAVETTE
19	REC57610-96311	57610-96311	EJE HELICE	PROPELLER SHAFT	ASSE ELICA	ARBRE D'HELICE
20	REC57521-89J00	57521-89J00	PIÑÓN MARCHA ATRÁS	REVERSER GEAR	PIGNONE MARCIA INDIETRO	PIGNON MARCHE ARRIÈRE
21	REC09280-75001	09280-75001	ARO TÓRICO	O-RING	FASCIA TONDA	JOINT TORIQUE
22	REC08113-60060	08113-60060	RODAMIENTO	BEARING	CUSCINETTO	ROULEMENT
23	REC56120-96332-0EP	56120-96332-0EP	DIÁBOLO	CARRIER	DIABOLO	DIABOLO
24	REC09116-06121	09116-06121	TORNILLO	BOLT	VITE	VIS
25	REC09263-20047	09263-20047	RODAMIENTO	BEARING	CUSCINETTO	ROULEMENT
26	REC09289-20009	09289-20009	RETÉN ACEITE	OIL SEAL	PARAOILIO	JOINT SPI
27	REC91490-40030	09204-03003	PIN BLOQUEADOR	COTTER PIN	COPPIGLIA	GOUPILLE
28	REC90179-08M06	09159-08046	TUERCA DE PIÑÓN M8X1	NUT, PINION M8X1	DADO PIGNONE M8X1	ECROU DE PIGNON M8
29	REC57311-96320	57311-96320	PIÑÓN ATAQUE	INITIATIVE GEAR	PIGNONE ATTACCO	PIGNON D'ATTAQUE

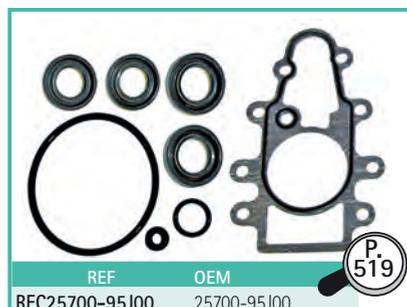

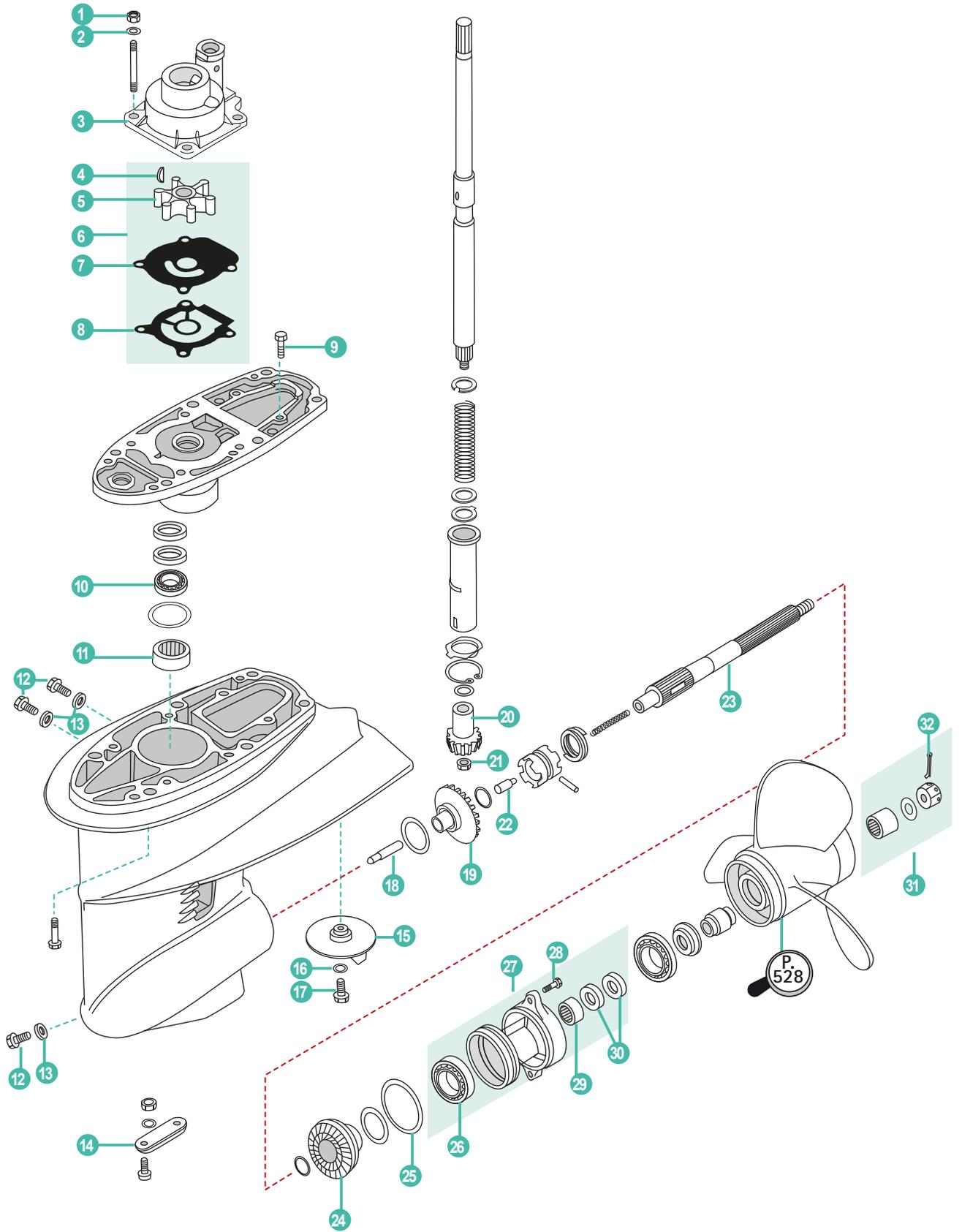

	REF	OEM				
1	PAGB/T6184-2000	09141-06020	TUERCA M6	NUT M6	DADO M6	ÉCROU M6
2	PAGB/T848-6	09162-06006	ARANDELA	WASHER	RONDELLA	RONDELLE
3	REC17411-94421	17411-94421	CUERPO BOMBA AGUA	HOUSING WATER PUMP	CORPO POMPA ACQUA	CORPS DE POMPE À EAU
4	REC09420-04006	09420-04006	CHAVETA	KEY	CHIAVETTA	CLAVETTE
5	REC17461-96312	17461-96312	IMPULSOR	IMPELLER	GIRANTE	TURBINE
6	REC17400-96403	17400-96352	KIT BOMBA DE AGUA	WATER PUMP KIT	KIT POMPA ACQUA	KIT POMPE A EAU
7	REC17471-94401	17471-94401	BASE BOMBA AGUA	PLATE, WATER PUMP	BASE POMPA ACQUA	BASE DE POMPE À EAU
8	REC17472-96303	17472-96303	JUNTA DE LA BOMBA DE AGUA	WATER PUMP, GASKET	GUARNIZIONE POMPA ACQUA	JOINT POMPE À EAU
9	PAGB/T5787-M6X20	09116-06106	TORNILLO	BOLT, FLANGE	VITE	VIS DE BRIDE
10	REC09265-17002	09265-17002	RODAMIENTO	BEARING	CUSCINETTO	ROULEMENT
11	REC09263-20046	09263-20046	RODAMIENTO	BEARING	CUSCINETTO	ROULEMENT
12	REC09248-10008	09248-10008	TORNILLO 10x7,5	SCREW 10x7,5	VITE 10x7,5	VIS 10x7,5
13	REC09168-10022	09168-10022	ARANDELA TAPÓN	CAP, O-RING	RONDELLA TAPPO	JOINT DE VIDANGE
14	CM55300-95500	55300-95500	ÁNODO	ANODE	ANODO	ANODE
15	CM55125-96310	55125-96310	ÁNODO	ANODE	ANODO	ANODE
16	PAGB/T97.1-8		ARANDELA 8	WASHER 8	RONDELLA 8	RONDELLE 8
17	PAGB/T5783-M8X16	09117-08037	TORNILLO M8x16	BOLT M8x16	BULLONE M8x16	BOULON M8x16
18	REC57631-96301	57631-96301	VARILLA PRESION ACEITE	ROD PUSH	ASTA PRESSIONE OLIO	CLAVETTE
19	REC57510-89J00	57510-89J00	PIÑÓN MARCHA AVANTE	POSITIVE GEAR	PIGNONE MARCIA AVANTI	PIGNON MARCHE AVANT
20	REC57311-96320	57311-96320	PIÑÓN ATAQUE	INITIATIVE GEAR	PIGNONE ATTACCO	PIGNON D'ATTAQUE
21	REC90179-08M06	09159-08046	TUERCA DE PIÑÓN M8X1	NUT, PINION M8X1	DADO PIGNONE M8X1	ECROU DE PIGNON M8
22	REC09209-08016	09209-08016	VARILLA PRESION ACEITE	ROD PUSH	ASTA PRESSIONE OLIO	CLAVETTE
23	REC57610-96311	57610-96311	EJE HELICE	PROPELLER SHAFT	ASSE ELICA	ARBRE D'HELICE
24	REC57521-89J00	57521-89J00	PIÑÓN MARCHA ATRÁS	REVERSER GEAR	PIGNONE MARCIA INDIETRO	PIGNON MARCHE ARRIÈRE
25	REC925093	09280-75002	ARO TORICO SUPERIOR	O-RING UPPER	O-RING SUPERIORE	JOINT TORIQUE SUPERIEUR
26	REC08113-60060	08113-60060	RODAMIENTO	BEARING	CUSCINETTO	ROULEMENT
27	REC56120-96332-OEP	56120-96332-OEP	DIÁBOLO	CARRIER	DIABOLO	DIABOLO
28	REC09116-06121	09116-06121	TORNILLO	BOLT	VITE	VIS
29	REC09263-20047	09263-20047	RODAMIENTO	BEARING	CUSCINETTO	ROULEMENT
30	REC09289-20009	09289-20009	RETÉN ACEITE	OIL SEAL	PARAOLIO	JOINT SPI
31	REC57630-96300	57630-96300	KIT CIERRE DE HÉLICE	PROP NUT KIT	KIT CHIUSURA ELICA	KIT ECROU D'HELICE
32	REC91490-40030	09204-03003	PIN BLOQUEADOR	COTTER PIN	COPPIGLIA	GOUPILLE

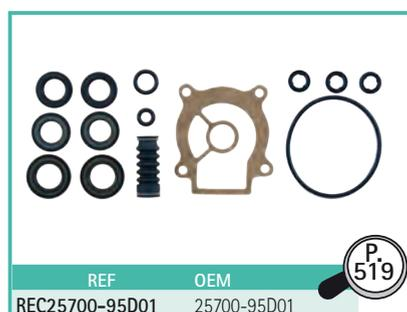

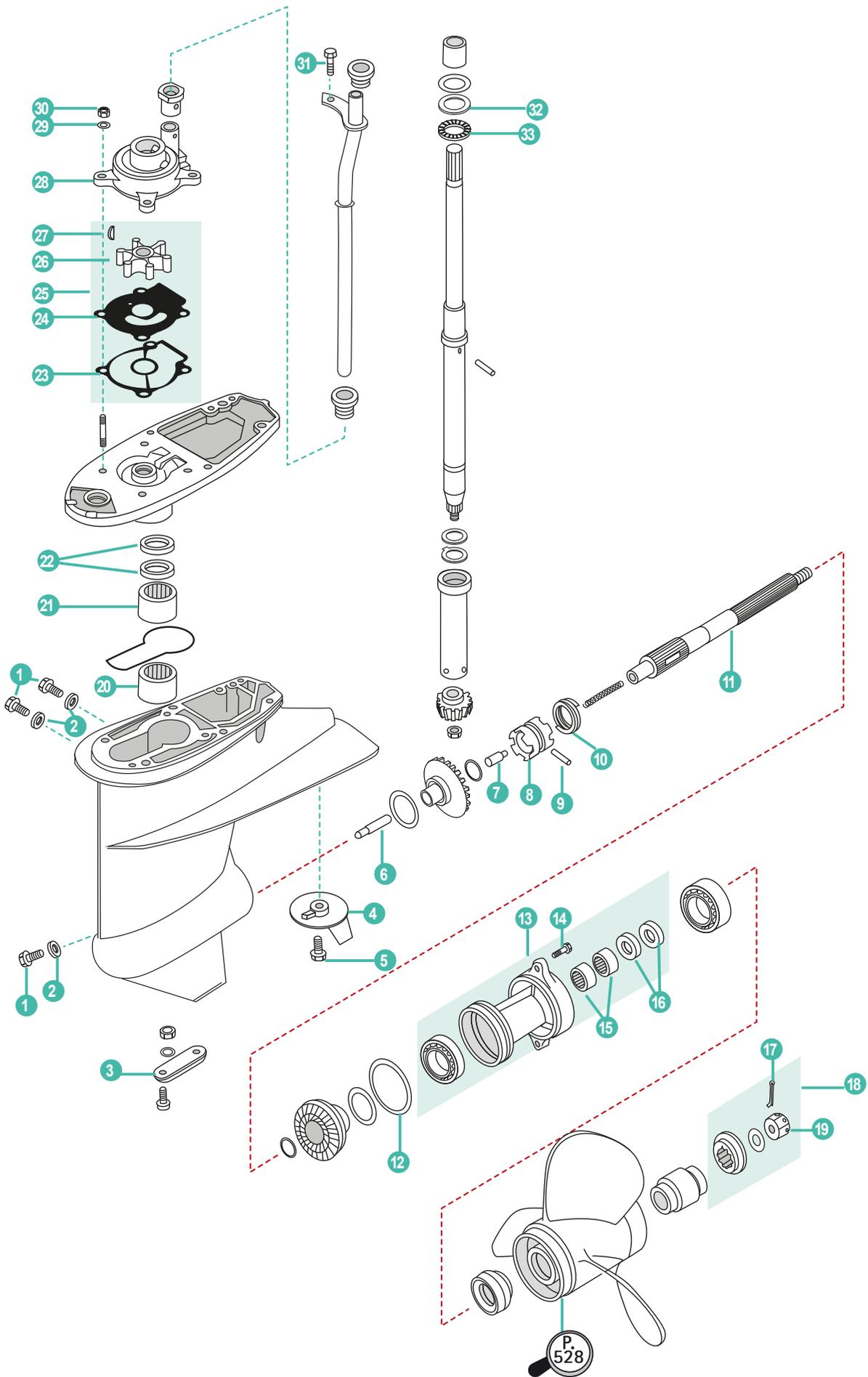

	REF	OEM				
1	REC09248-10008	09248-10008	TORNILLO 10x7,5	SCREW 10x7,5	VITE 10x7,5	VIS M10x7,5
2	REC09168-10022	09168-10022	ARANDELA TAPÓN	CAP, O-RING	RONDELLA TAPPO	JOINT DE VIDANGE
3	CM55300-95500	55300-95500	ÁNODO	ANODE	ANODO	ANODE
4	CM55125-95500	55125-95500	ÁNODO	ANODE	ANODO	ANODE
5	PAGB/T5783-M8X16	09117-08109	TORNILLO M8x16	BOLT M8x16	BULLONE M8x16	BOULON M8x16
6	REC57631-95303	57631-95303	VARILLA PRESION ACEITE	ROD PUSH	ASTA PRESSIONE OLIO	CLAVETTE
7	REC57634-88L00	57634-88L00	PIN SELECTOR	CLUTCH PIN	PIN SELETTORE	CALVETTE
8	REC57621-94403	57621-87J03	SELECTOR	SELETTORE	CLUTCH DOG	CRABOT
9	REC09202-04002	09202-04002	PIN HELICE	PROPELLER PIN	PIN ELICA	CLAVETTE D'HELICE
10	REC09440-40002	09440-40002	MUELLE SELECTOR	SPRING CLUTCH	MOLLA SELETTORE	RESSORT
11	REC57610-94402	57610-94402	EJE HELICE	PROPELLER SHAFT	ASSE ELICA	ARBRE D'HELICE
12	REC09280-75001	09280-75001	ARO TÓRICO	O-RING	FASCIA TONDA	JOINT TORIQUE
13	REC56120-94321-0EP	56120-94321-0EP	DIÁBOLO	CARRIER	DIABOLO	DIABOLO
14	PAGB/T5783-M8X30	09117-08047	TORNILLO M8x30	BOLT M8x30	BULLONE M8x30	BOULON M8x30
15	REC09263-22020	09263-22020	RODAMIENTO	BEARING	CUSCINETTO	ROULEMENT
16	REC09289-22007	09289-22007	RETÉN ACEITE	OIL SEAL	PARAOLIO	JOINT SPI
17	REC91490-40030	09204-03003	PIN BLOQUEADOR	COTTER PIN	COPPIGLIA	GOUPILLE
18	REC57630-94300	57630-94301	KIT CIERRE DE HÉLICE	PROP NUT KIT	KIT CHIUSURA ELICA	KIT ECROU D'HELICE
19	REC90171-18M04	09141-18005	TUERCA	NUT	DADO	ÉCROU
20	REC09263-22L03	09263-22039	RODAMIENTO	BEARING	CUSCINETTO	ROULEMENT
21	REC09263-25025	09263-25025	RODAMIENTO	BEARING	CUSCINETTO	ROULEMENT
22	REC09282-17005	09282-17005	RETÉN ACEITE	OIL SEAL	PARAOLIO	JOINT SPI
23	REC17472-96303	17472-96303	JUNTA DE LA BOMBA DE AGUA	WATER PUMP, GASKET	GUARNIZIONE POMPA ACQUA	JOINT POMPE À EAU
24	REC17471-94401	17471-94401	BASE BOMBA AGUA	PLATE, WATER PUMP	BASE POMPA ACQUA	BASE DE POMPE À EAU
25	REC17400-96403	17400-96403	KIT BOMBA DE AGUA	WATER PUMP KIT	KIT POMPA ACQUA	KIT POMPE A EAU
26	REC17461-96312	17461-96312	IMPULSOR	IMPELLER	GIRANTE	TURBINE
27	REC09420-04006	09420-04006	CHAVETA	KEY	CHIAVETTA	CLAVETTE
28	REC17411-94421	17411-94421	CUERPO BOMBA AGUA	HOUSING WATER PUMP	CORPO POMPA ACQUA	CORPS DE POMPE À EAU
29	PAGB/T93-6	29162-93J00	ARANDELA 6	WASHER 6	RONDELLA 6	RONDELLE 6
30	PAGB/T6170-M6	29141-93J00	TUERCA HEXÁGONO M6	NUT HEXAGON M6	DADO ESAGONALE M6	ECROU HEXAGONAL M6
31	REC09116-06094	09116-06094	TORNILLO 6x15	SCREW 6x15	VITE 6x15	VIS 6x15
32	REC09160-26015	09160-26015	ARANDELA PIÑÓN	WASHER GEAR	RONDELLA PIGNONE	RONDELLE DE PIGNON
33	REC09263-25062	09263-25062	RODAMIENTO	BEARING	CUSCINETTO	ROULEMENT

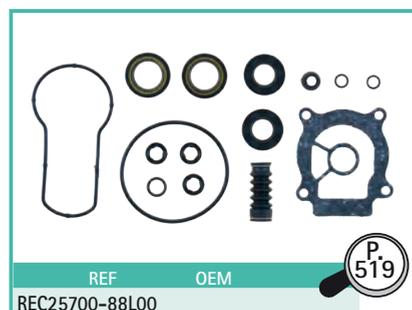

4T DF40A, DF50A, DF60A  
STROKES

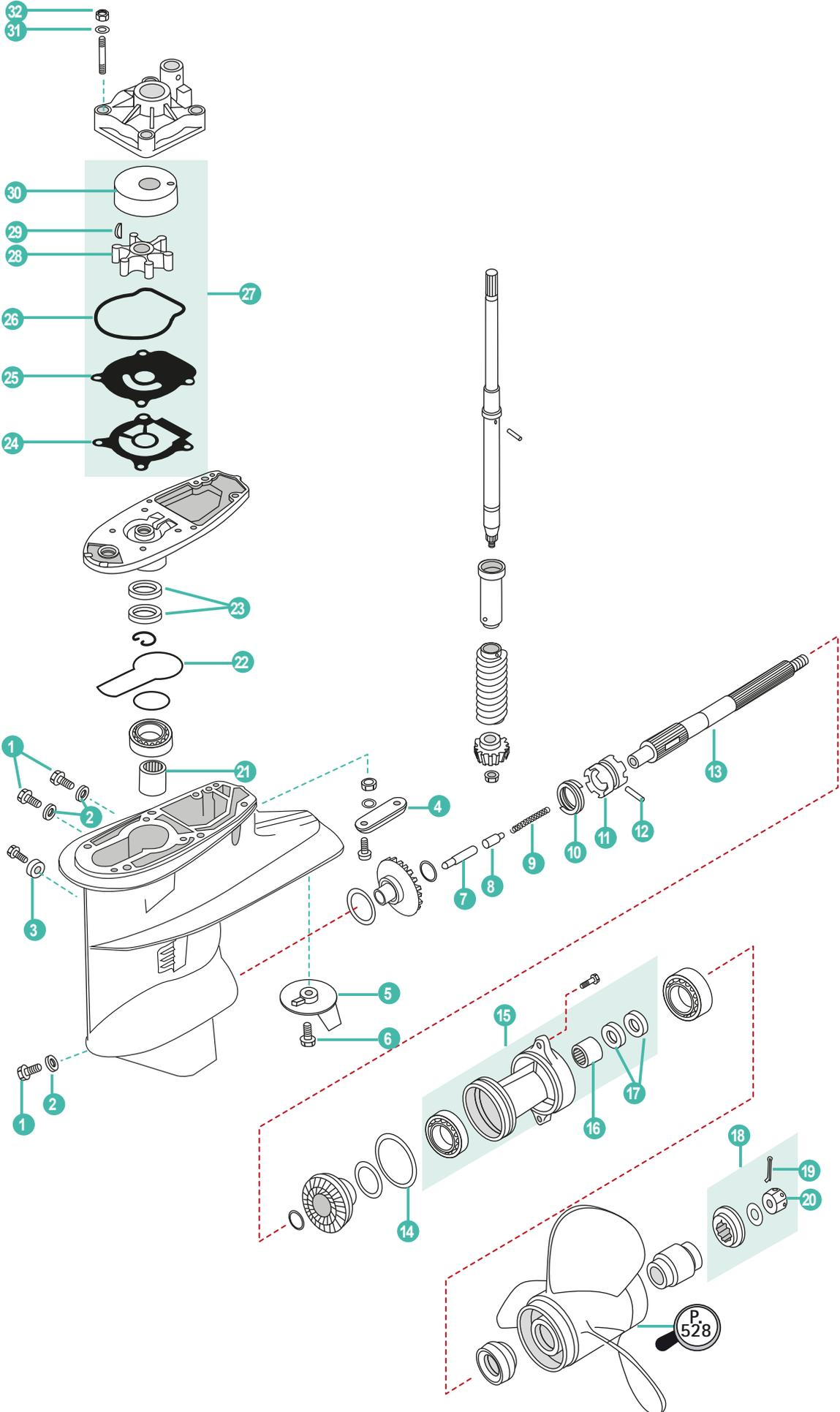

SUZUKI

RECAMBIOS  
MARINOS

P. 528



	REF	OEM				
1	REC09248-10008	09248-10008	TORNILLO 10x7,5	SCREW 10x7,5	VITE 10x7,5	VIS 10x7,5
2	REC09168-10022	09168-10022	ARANDELA TAPÓN	CAP, O-RING	RONDELLA TAPPO	JOINT DE VIDANGE
3	CM55321-87J00	55321-87J00	ÁNODO	ANODE	ANODO	ANODE
4	CM55300-95500	55300-95500	ÁNODO	ANODE	ANODO	ANODE
5	CM55125-94400	55125-94400	ÁNODO	ANODE	ANODO	ANODE
6	PAGB/T5783-M8X16	09117-08109	TORNILLO M8x16	BOLT M8x16	BULLONE M8x16	BOULON M8x16
7	REC57631-95303	57631-95303	VARILLA DE PRESIÓN	ROD PUSH	ASTA PRESSIONE OLIO	DOIGT
8	REC57634-88L00	57634-88L00	PIN SELECTOR	CLUTCH PIN	PIN SELETTORE	CALVETTE
9	REC09440-08043	09440-08043	MUELLE SELECTOR	SPRING CLUTCH	MOLLA SELETTORE	RESSORT DE SELECTEUR
10	REC09440-40002	09440-40002	MUELLE SELECTOR	SPRING CLUTCH	MOLLA SELETTORE	RESSORT DE SELECTEUR
11	REC57621-94403	57621-87J03	SELECTOR	SELETTORE	CLUTCH DOG	CRABOT
12	REC09202-05022	09202-05022	PIN SELECTOR	CLUTCH PIN	PIN SELETTORE	CALVETTE
13	REC57610-94402	57610-94402	EJE HELICE	PROPELLER SHAFT	ASSE ELICA	ARBRE D'HELICE
14	REC09280-75001	09280-75001	ARO TÓRICO	O-RING	FASCIA TONDA	JOINT TORIQUE
15	REC56120-94321-0EP	56120-94321-0EP	DIÁBOLO	CARRIER	DIABOLO	DIABOLO
16	REC09263-22020	09263-22020	RODAMIENTO	BEARING	CUSCINETTO	ROULEMENT
17	REC09289-22007	09289-22007	RETÉN ACEITE	OIL SEAL	PARAOLIO	JOINT SPI
18	REC57630-94300	57630-94300	KIT CIERRE DE HÉLICE	PROP NUT KIT	KIT CHIUSURA ELICA	KIT ECROU D'HELICE
19	REC91490-40030	09204-03003	PIN BLOQUEADOR	COTTER PIN	COPPIGLIA	GOUPILLE
20	REC90171-18M04	09141-18005	TUERCA	NUT	DADO	ÉCROU
21	REC09263-22L03	09263-22039	RODAMIENTO	BEARING	CUSCINETTO	ROULEMENT
22	REC55122-94400	55122-88L00	JUNTA TORICA	O-RING	O-RING	JOINT TORIQUE
23	REC09282-17005	09282-17005	RETÉN ACEITE	OIL SEAL	PARAOLIO	JOINT SPI
24	REC17472-96303	17472-96303	JUNTA DE LA BOMBA DE AGUA	WATER PUMP, GASKET	GUARNIZIONE POMPA ACQUA	JOINT POMPE À EAU
25	REC17471-95J01	17471-95J01	TAPA DEL IMPULSOR	OUTER PLATE CARTRIDGE	COPERCHIO GIRANTE	PLAQUE DE POMPE À EAU
26	REC17416-95J00	17416-95J00	ARO TÓRICO	O-RING	FASCIA TONDA	JOINT TORIQUE
27	REC17400-88L00	17400-88L00	KIT BOMBA DE AGUA	WATER PUMP KIT	KIT POMPA ACQUA	KIT POMPE A EAU
28	REC17461-96312	17461-96312	IMPULSOR	IMPELLER	GIRANTE	TURBINE
29	REC09420-04006	09420-04006	CHAVETA	KEY	CHIAVETTA	CLAVETTE
30	REC17413-95J00	17413-95J00	CASQUILLO INOX	SLEEVE WATER PUMP	CAPPUCCIO	INSERT DE POMPE À EAU
31	PAGB/T93-6	29162-93J00	ARANDELA MUELLE 6	WASHER SPRING 6	RONDELLA MOLLA 6	RESSORT 6
32	PAGB/T6170-M6	29141-93J00	TUERCA HEXÁGONO M6	NUT HEXAGON M6	DADO ESAGONALE M6	ECROU HEXAGONAL M6

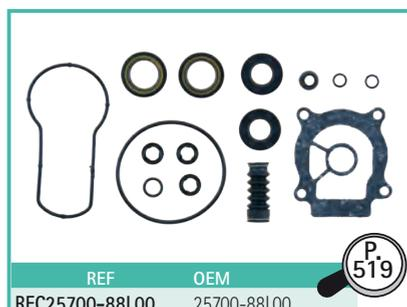

4T DF60, DF70  
STROKES

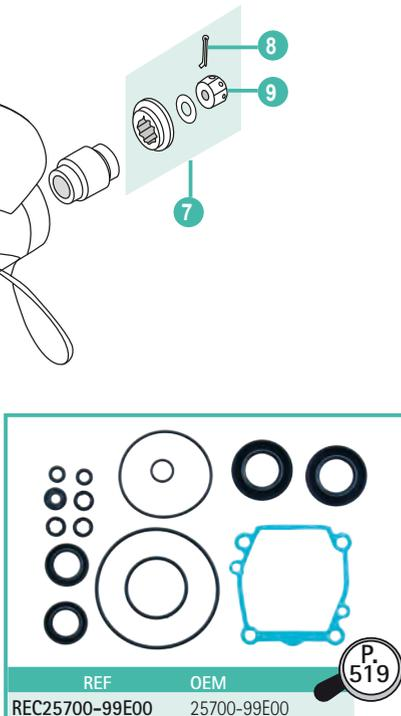
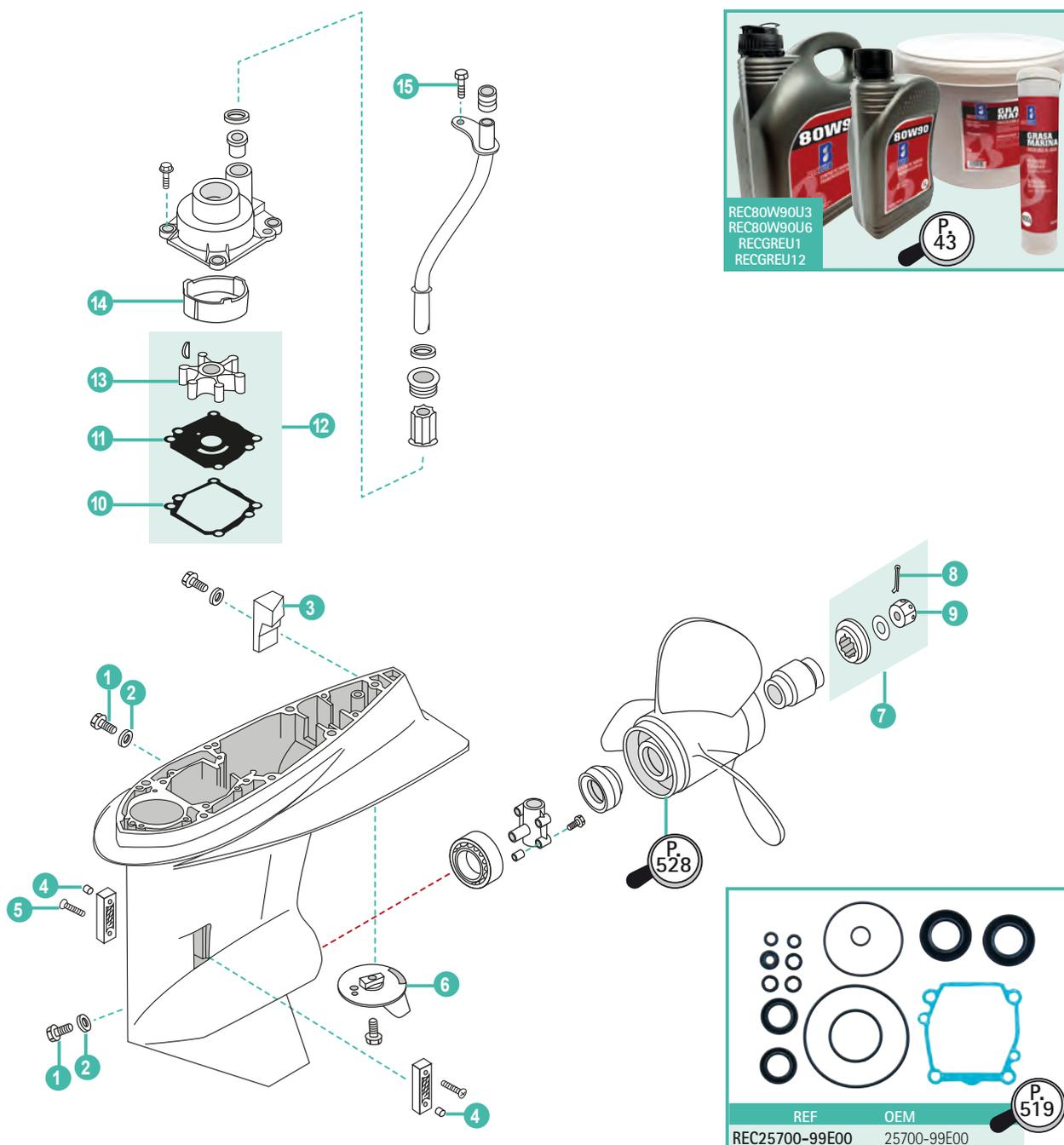

REF	OEM				
1	REC09248-10008	09248-10008	TORNILLO 10x7,5	SCREW 10x7,5	VITE 10x7,5
2	REC09168-10022	09168-10022	ARANDELA TAPÓN	CAP, O-RING	RONDELLA TAPPO
3	CM55321-90J01	55321-90J01	ÁNODO	ANODE	ANODO
4	PAGB/T889.1-M4	09140-04007	TUERCA HEXAGONAL M4	NUT HEXAGON M4	DADO ESAGONALE M4
5	PAGB/T818-M4X30	09125-04023	TORNILLO M4x30	SCREW PAN HEAD M4x30	VITE TESTA M4x30
6	TEN01215	55125-90J01	ÁNODO	ANODE	ANODO
7	REC57630-94500	57630-94500	KIT CIERRE HELICE	PROP NUT KIT	KIT CHIUSURA ELICA
8	REC91490-40030	09204-03003	PIN BLOQUEADOR	COTTER PIN	COPPIGLIA
9	REC90171-18M04	09141-18005	TUERCA	NUT	DADO
10	REC17472-87E10	17472-87E10	JUNTA BOMBA AGUA	WATER PUMP GASKET	GUARZIONE POMPA ACQUA
11	REC17471-92J00	17471-87E01	PLACA BOMBA DE AGUA	PATE, WATER PUMP	PLACCA POMPA ACQUA
12	REC17400-87E04	17400-87E03	KIT REPARACION BOMBA AGUA	WATER PUMP KIT	KIT RIPARAZIONE POMPA ACQUA
13	REC17461-87E12	17461-87E12	IMPULSOR	IMPELLER	GIRANTE
14	REC17413-99E11	17413-99E10	CASQUILLO INOX	INSERT CUP	GHIERA INOX
15	PAGB/T5783-M6X16	09116-06225	TORNILLO HEXAGONAL M6x16	BOLT HEXAGON M6x16	BULLONE ESAGONALE M6x16

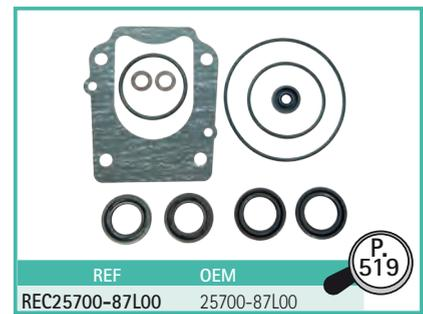
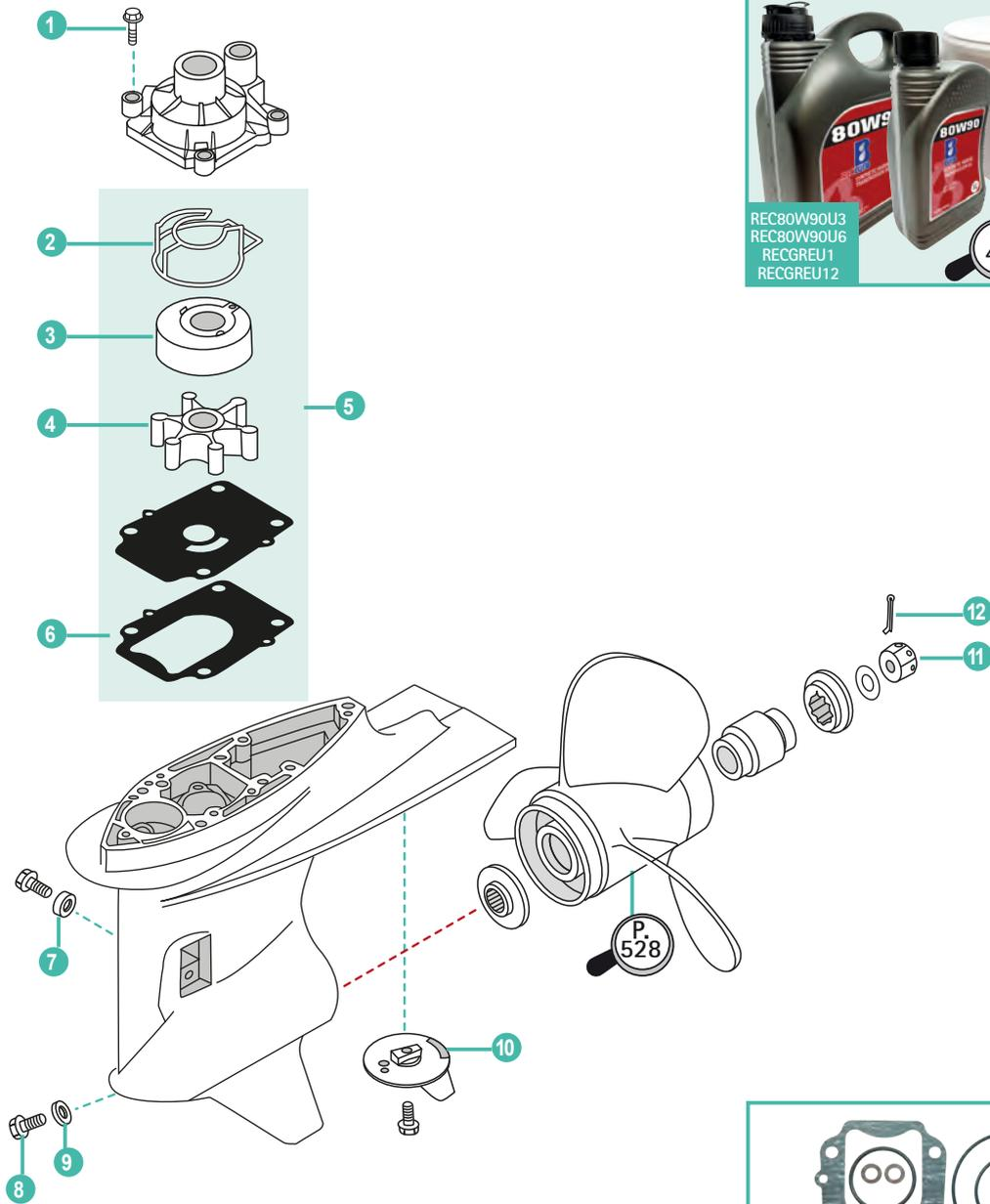

REF	OEM					
1	PAF8-00000003	29116-93J10	TORNILLO M8x35	BOLT M8x35	BULLONE M8x35	BOULON M8x35
2	REC17416-99E10	17416-99E10	JUNTA TORICA	O-RING	O-RING	JOINT TORIQUE
3	REC17413-99E11	17413-99E10	CASQUILLO INOX	INSERT CUP	GHIERA INOX	INSERT INOX POMPE A EAU
4	REC17461-87E12	17461-87E12	IMPULSOR	IMPELLER	GIRANTE	TURBINE
5	REC17400-87L01	17400-87L01	KIT BOMBA DE AGUA	WATER PUMP KIT	KIT POMPA ACQUA	KIT POMPE A EAU
6	REC17472-87L00	17472-87L00	JUNTA BOMBA AGUA	WATER PUMP GASKET	GUARZIONE POMPA ACQUA	JOINT DE POMPE À EAU
7	CM55321-87J00	55321-87J00	ÁNODO	ANODE	ANODO	ANODE
8	REC09248-10008	09248-10008	TORNILLO 10x7,5	SCREW 10x7,5	VITE 10x7,5	VIS 10x7,5
9	REC09168-10034	09168-10034	JUNTA	GASKET	GUARNIZIONE	JOINT DE VIDANGE
10	TEN01215	55125-90J01	ÁNODO	ANODE	ANODO	ANODE
11	REC90171-18M04	09141-18005	TUERCA	NUT	DADO	ECROU D'HELICE
12	REC91490-40030	09204-03003	PIN BLOQUEADOR	COTTER PIN	COPPIGLIA	GOUPILLE

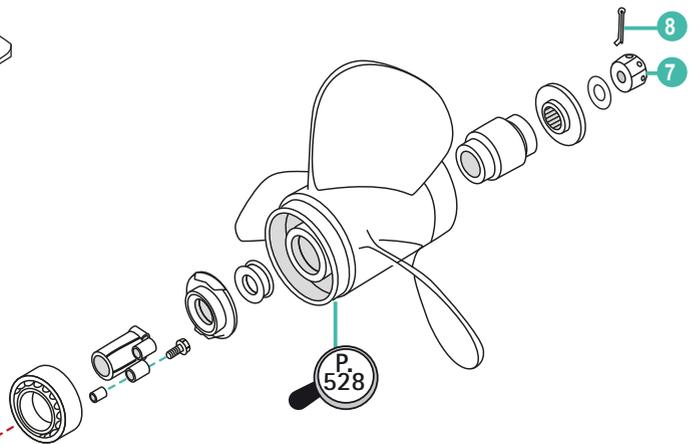
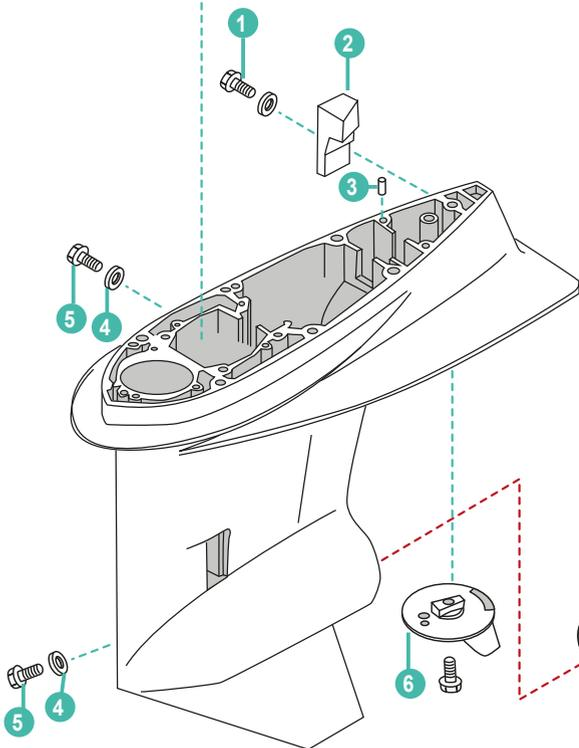
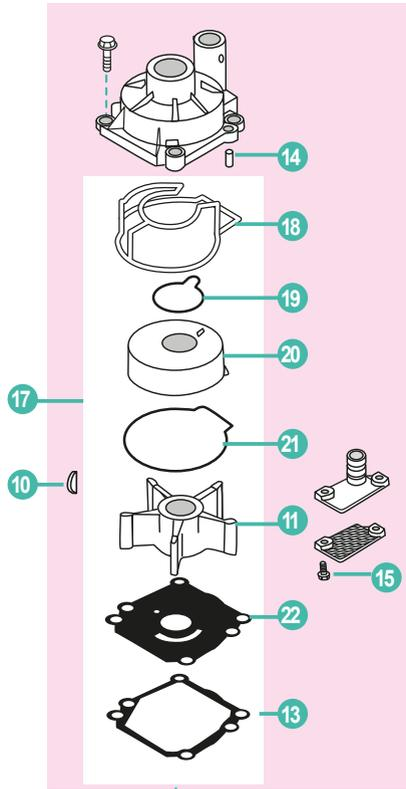
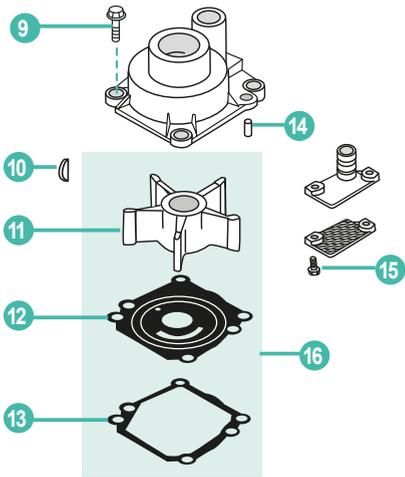

	REF	OEM				
1	PAGB/T5783-M6X12	09100-06130	TORNILLO M6x12	BOLT M6x12	BULLONE M6x12	BOULON M6x12
2	CM55321-90J01	55321-90J01	ÁNODO	ANODE	ANODO	ANODE
3	PAF25-00000014	09202-08006	PIN CENTRADOR F8x12	PIN, DOWEL F8x12	PIN, CENTRAGGIO F8x12	GOUPILLE FENDUE 8x12
4	REC09168-10022	09168-10022	TORNILLO 10x7,5	SCREW 10x7,5	VITE 10x7,5	VIS M10x7,5
5	REC09248-10008	09248-10008	ARANDELA TAPÓN	CAP, O-RING	RONDELLA TAPPO	JOINT DE VIDANGE
6	TEN01215	55125-90J01	ÁNODO	ANODE	ANODO	ANODE
7	REC90171-18M04	09141-18005	TUERCA	NUT	DADO	ÉCROU
8	REC91490-40030	08204-03003	PIN BLOQUEADOR	COTTER PIN	COPPIGLIA	GOUPILLE
			MODELOS ANTIGUOS	OLDER MODELS	MODELLI VECCHIO	ANCIENS MODELES
9	PAGB/T5783-M8X25	09117-08057	PERNO M8X25	BOLT M8X25	BULLONE M8	BOULON M8X25
10	REC09420-05009	09420-05009	CHAVETA	KEY	CHIAVETTA	CLAVETTE
11	REC17461-90J01	17461-90J01	IMPULSOR	IMPELLER	GIRANTE	TURBINE
12	REC17471-92J00	17471-92J00	TAPA DEL IMPULSOR	OUTER PLATE CARTRIDGE	COPERCHIO GIRANTE	PLAQUE DE POMPE À EAU
13	REC17472-87E10	17472-87E10	JUNTA BOMBA AGUA	WATER PUMP GASKET	GUARZIONE POMPA ACQUA	JOINT DE POMPE À EAU
14	REC93606-12019	09202-06031	PIN F6X12	PIN F6X12	SPINOTTO F6X12	LEVIER F6X12
15	PAGB/T8.8-2000	09125-05046	TORNILLO M5X12	SCREW, PAN HEAD M5X12	VITE M5X12	VIS M5X12
16	REC17400-90J20	17400-90J20	KIT BOMBA DE AGUA	WATER PUMP KIT	KIT POMPA ACQUA	KIT POMPE A EAU
			MODELOS MODERNOS	NEWER MODELS	MODELLI MODERNI	MODELES RECENTS
17	REC17400-92J21	17400-92J21	KIT BOMBA DE AGUA	WATER PUMP KIT	KIT POMPA ACQUA	KIT POMPE A EAU
18	REC17416-92J10	17416-92J10	TÓRICA BOMBA DE AGUA	WATER PUMP, SEAL	FASCIA TONDA	JOINT TORIQUE
19	REC17417-92J00	17417-92J00	JUNTA TORICA	O-RING	O-RING	JOINT TORIQUE
20	REC17413-92J01	17416-92J01	CASQUILLO INOX	INSERT CUP	GHIERA INOX	INSERT INOX POMPE A EAU
21	REC17416-92J00	17416-92J00	JUNTA TORICA	O-RING	O-RING	JOINT TORIQUE
22	REC17471-92J00	17471-92J00	TAPA DEL IMPULSOR	OUTER PLATE CARTRIDGE	COPERCHIO GIRANTE	PLAQUE DE POMPE À EAU

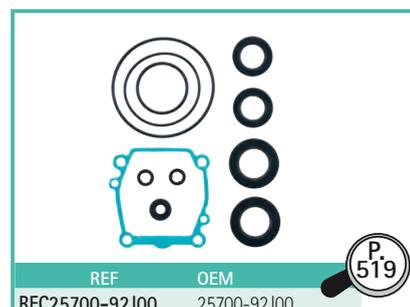
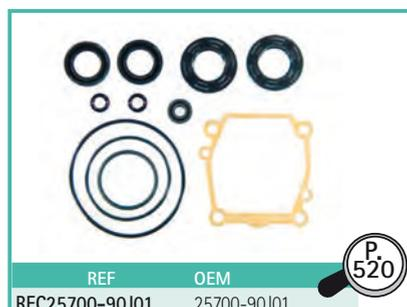

4T DF100A, DF115A, DF140A

STROKES

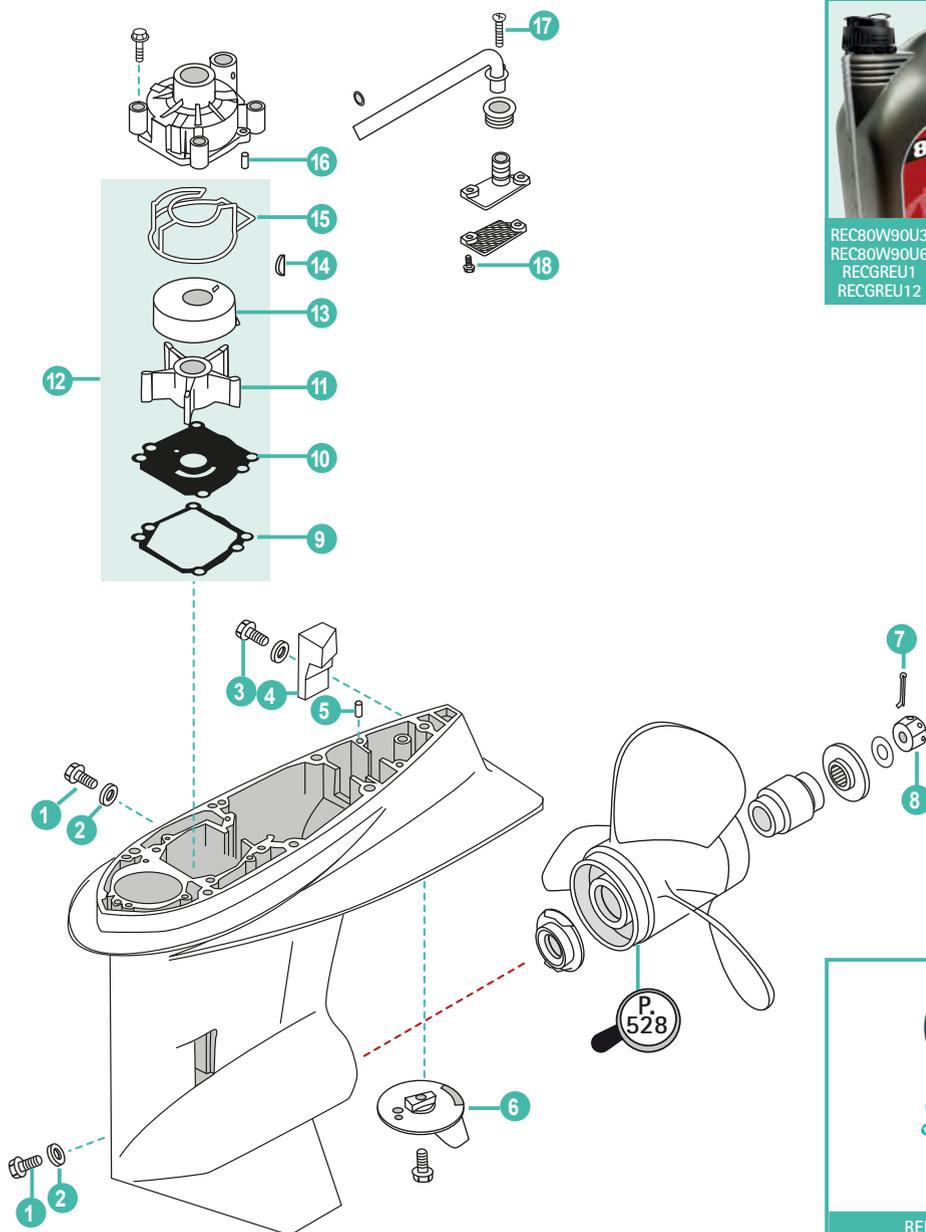

REC80W90U3  
REC80W90U6  
RECGREU1  
RECGREU12

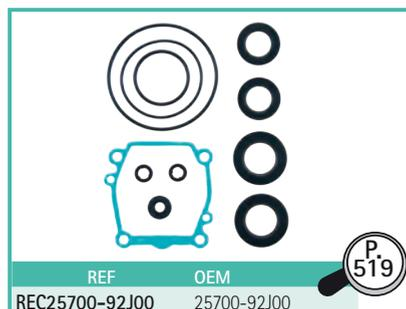

REF	OEM
REC25700-92J00	25700-92J00

	REF	OEM				
1	REC09248-10008	09248-10008	TORNILLO 10x7,5	SCREW 10x7,5	VITE 10x7,5	VIS 10x7,5
2	REC09168-10022	09168-10022	ARANDELA TAPÓN	CAP, O-RING	RONDELLA TAPPO	JOINT DE VIDANGE
3	PAGB/T5783-M6X12	09100-06130	TORNILLO M6x12	BOLT M6x12	BULLONE M6x12	BOULON M6x12
4	CM55321-90J01	55321-90J01	ÁNODO	ANODE	ANODO	ANODE
5	PAF25-00000014	09202-08006	PIN CENTRADOR F8x12	PIN, DOWEL F8x12	PIN, CENTRAGGIO F8x12	GOUPILLE FENDUE 8x12
6	TEN01215	55125-90J01	ÁNODO	ANODE	ANODO	ANODE
7	REC91490-40030	09240-03003	PIN BLOQUEADOR	COTTER PIN	COPPIGLIA	GOUPILLE
8	REC90171-18M04	09141-18005	TUERCA	NUT	DADO	ÉCROU
9	REC17472-87E10	17472-87E10	JUNTA BOMBA AGUA	WATER PUMP GASKET	GUARZIONE POMPA ACQUA	JOINT DE POMPE À EAU
10	REC17471-92J00	17471-92J00	TAPA DEL IMPULSOR	OUTER PLATE CARTRIDGE	COPERCHIO GIRANTE	PLAQUE DE POMPE À EAU
11	REC17461-90J01	17461-90J01	IMPULSOR	IMPELLER	GIRANTE	TURBINE
12	REC17400-92J21	17400-92J21	KIT BOMBA DE AGUA	WATER PUMP KIT	KIT POMPA ACQUA	KIT POMPE A EAU
13	REC17413-92J01	17413-92J01	CASQUILLO INOX	INSERT CUP	GHIERA INOX	INSERT INOX POMPE A EAU
14	REC09420-05009	09420-05009	CHAVETA	KEY	CHIAVETTA	CLAVETTE
15	REC17416-92J10	17416-92J10	TÓRICA BOMBA DE AGUA	WATER PUMP, SEAL	FASCIA TONDA	JOINT TORIQUE
16	REC93606-12019	09202-06031	PIN F6x12	PIN F6x12	SPINOTTO F6x12	LEVIER F6x12
17	PAGB/T818-M6X10	09125-06063	TORNILLO M6x10	BOLT M6x10	BULLONE M6x10	BOULON M6x10
18	PAGB/T8.8-2000	09125-05046	TORNILLO M5X12	SCREW, PAN HEAD M5X12	VITE M5X12	VIS M5X12

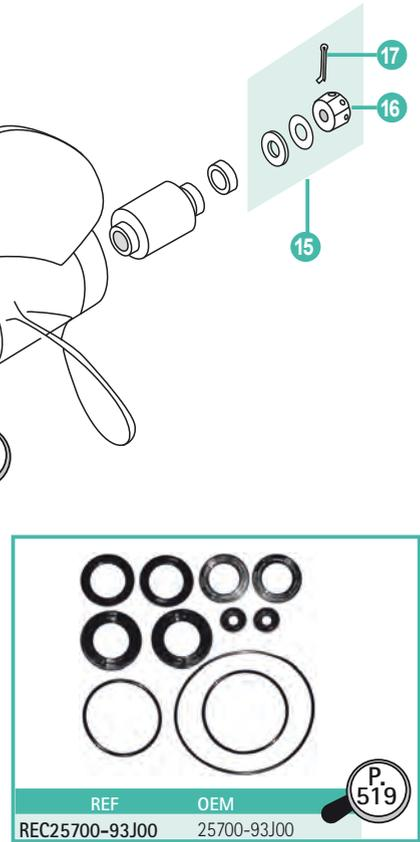
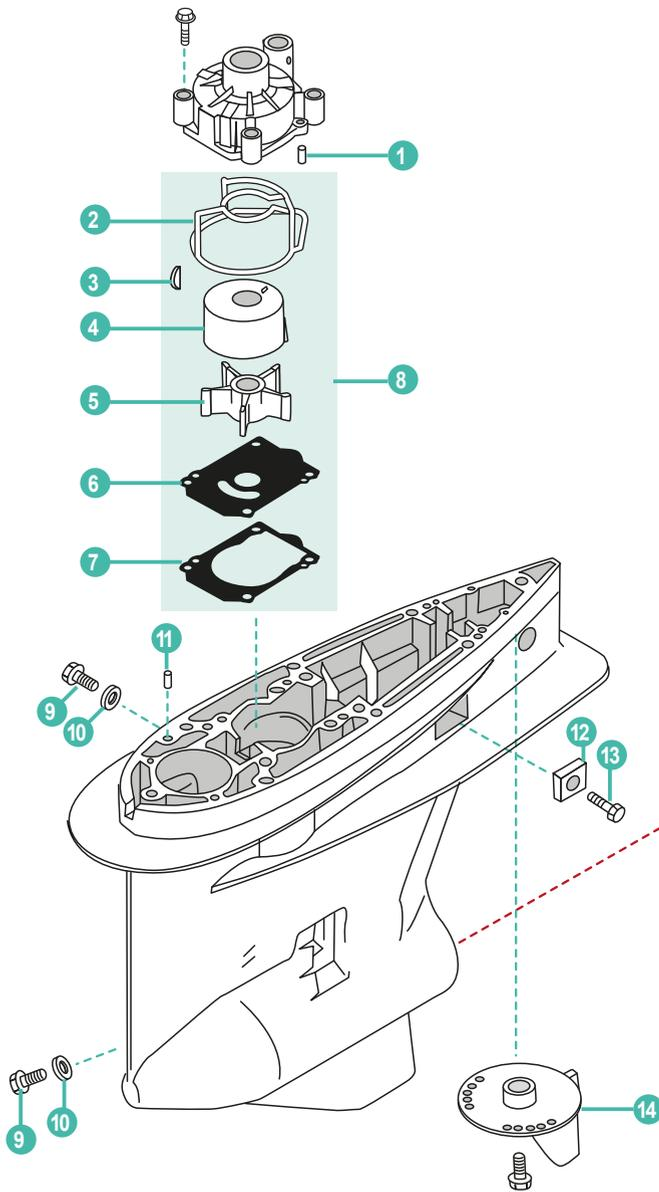

	REF	OEM				
1	REC93606-12019	09202-06031	PIN F6X12	PIN F6X12	SPINOTTO F6X12	LEVIER F6X12
2	REC17416-96J00	17416-96J00	JUNTA TORICA	O-RING	O-RING	JOINT TORIQUE
3	REC09420-05009	09420-05009	CHAVETA	KEY	CHIAVETTA	CLAVETTE
4	REC17413-96J01	17413-96J01	CASQUILLO INOX	SLEEVE WATER PUMP	CAPPUCCIO	INSERT DE POMPE À EAU
5	REC17461-90J01	17461-90J01	IMPULSOR	IMPELLER	GIRANTE	TURBINE
6	REC17471-92J02	17471-93J02	TAPA DEL IMPULSOR	IMPELLER PLATE	COPERCHIO GIRANTE	PLAQUE DE POMPE À EAU
7	REC17472-93J00	17472-93J00	JUNTA	GASKET	GUARNIZIONE	JOINT
8	REC17400-96J03	17400-96J03	KIT BOMBA DE AGUA	WATER PUMP KIT	KIT POMPA ACQUA	KIT POMPE A EAU
9	REC55128-93J10	55128-93J10	TAPON DRENAJE COLA	WATER PLUG DRAIN	GUARNIZIONE DRENAGGIO	BOUCHON DE VIDANGE
10	REC09168-10034	09168-10034	JUNTA	GASKET	GUARNIZIONE	JOINT
11	PAF25-00000014	09202-08006	PIN CENTRADOR F8x12	PIN, DOWEL F8x12	PIN, CENTRAGGIO F8x12	GOUPILLE FENDUE 8x12
12	CM55320-95310	55320-95311	ÁNODO	ANODE	ANODO	ANODE
13	REC09116-06094	09116-06094	TORNILLO 6x15	SCREW 6x15	VITE 6x15	VIS M6x15
14	TEN01215	55125-98J00	ÁNODO	ANODE	ANODO	ANODE
15	REC57630-92E00	57630-92E00	KIT CIERRE HELICE	PROP NUT KIT	KIT CHIUSURA ELICA	KIT ECROU D'HELICE
16	REC90171-18M04	09141-18005	TUERCA	NUT	DADO	ÉCROU
17	REC91490-40030	09204-03003	PIN BLOQUEADOR	COTTER PIN	COPPIGLIA	GOUPILLE

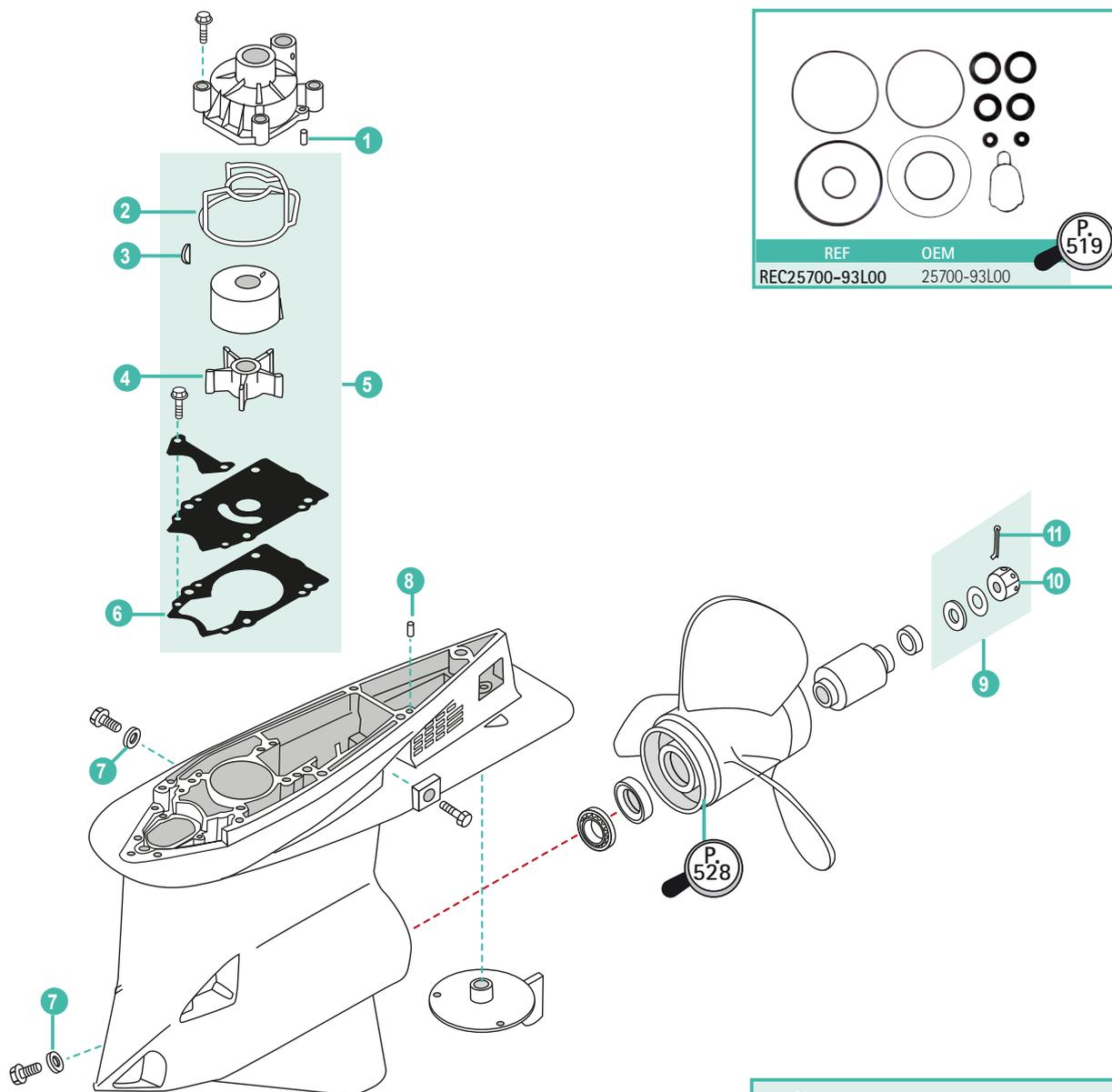

	REF	OEM				
1	REC93606-12019	09202-06031	PIN F6X12	PIN F6X12	SPINOTTO F6X12	LEVIER F6X12
2	REC17416-93J00	17416-93J00	TÓRICA BOMBA DE AGUA	WATER PUMP, SEAL	FASCIA TONDA	JOINT TORIQUE
3	REC09420-05009	09420-05009	CHAVETA	KEY	CHIAVETTA	CLAVETTE
4	REC17461-93J00	17461-93J00	IMPULSOR	IMPELLER	GIRANTE	TURBINE
5	REC17400-98J01	17400-98J01	KIT BOMBA DE AGUA	WATER PUMP KIT	KIT POMPA ACQUA	KIT POMPE A EAU
6	REC17472-98J00	17472-98J00	JUNTA BASE BOMBA	CASE PANEL GASKET	GUARNIZIONE BASE POMPA	JOINT DE BASE
7	REC09168-10034	09168-10034	JUNTA	GASKET	GUARNIZIONE	JOINT
8	PAF25-00000014	09202-08006	PIN CENTRADOR F8x12	PIN, DOWEL F8x12	PIN, CENTRAGGIO F8x12	GOUPILLE FENDUE 8x12
9	REC57630-92E00	57630-92E00	KIT CIERRE HELICE	PROP NUT KIT	KIT CHIUSURA ELICA	KIT ECROU D'HELICE
10	REC90171-18M04	90171-18M04	TUERCA	NUT	DADO	ÉCROU
11	REC91490-40030	09204-03003	PIN BLOQUEADOR	COTTER PIN	COPPIGLIA	GOUPILLE



# COMPONENTES DE COLA

# DRIVE COMPONENTS

# COMPONENTI PIEDI PIECES D' EMBASES

## KITS JUNTAS Y RETENES

## SEALS KITS

## KIT GUARNIZIONE E TENUTE

## KITS JOINTS D'EMBASES

REF	OEM
REC25700-87E00	25700-87E00

DF60, DF70 W-K9 (1998-09)  
DT90, DT100L-Y (1990-00)

**new**

REF	OEM
REC25700-87L00	25700-87L00

DF70A, DF80A, DF90A (2009+)

**new**

REF	OEM
REC25700-93L00	25700-93L00

DF250AP, DF300AP

**new**

REF	OEM
REC25700-92J00	25700-92J00

DF100A, DF115A, DF140A (2013+)  
DF140 (2002-12)

REF	OEM
REC25700-95D01	25700-95D01 25700-95D00

DF25, DF30Y-K6 (2000-06)  
DT25C, DT30C-K-Y (1989-00)

REF	OEM
REC25700-87D00	25700-87D00

DT150, DT200,  
DT225W-K3 (1998-03)  
V6H-Y (1987-00)

REF	OEM
REC25700-88L00	25700-94400 25700-88400

DF40, DF50X-K10 (1999-10)  
DF40A, DF50A, DF60A (2010+)

REF	OEM
REC25700-93J00	25700-93J00

DF150, DF175T/Z (G) (2006-14)  
DF200, DF225, DF250 (2004+)  
DF200A (2015)

REF	OEM
REC25700-94700	25700-94700

DT55, DT65J-X (1988-99)

REF	OEM
REC25700-99E00	25700-99E00

DF40A, DF50A, DF60A (2014+)  
DF60, DF70W-K9 (1998-09)

REF	OEM
REC25700-95501	25700-95500

DT75, DT85J-Y (1988-00)

REF	OEM
REC25700-95J00	25700-95J00

DF20R, DF25, DF25R-V2 (2006-11)

REF	OEM
REC25700-98J00	25700-98J00

DF300T/Z (2007-11)

REF	OEM
REC25700-98J00	25700-98J00

DF300T/Z (2007-11)

SUZUKI

RECAMBIOS MARINOS

REF	OEM
REC25700-94500	25700-94500



DT115, DT140G-Y (1986-00)

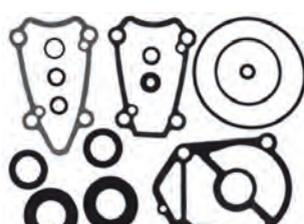

REF	OEM
REC25700-90J01	25700-90J01



DF90, DF100, DF115 K1-K11 (2001-11)  
DF115WT, DF140WT-K3 (2003)

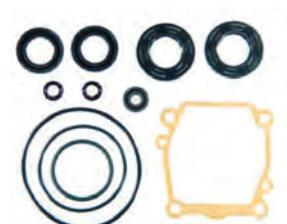

GUÍA KITS DE JUNTAS	GUIDE OF GASKETS KITS	GUIDA KIT GUARNIZIONE	GUIDE DES KITS JOINTS																		
 <table border="1"> <thead> <tr> <th>REF</th> </tr> </thead> <tbody> <tr> <td>DT25C DT30C</td> </tr> <tr> <td>DT55 DT65</td> </tr> <tr> <td>DT75 DT85</td> </tr> <tr> <td>DT115 DT140</td> </tr> <tr> <td>V6 2-STROKE 1989-03</td> </tr> <tr> <td>DF25 DF30</td> </tr> <tr> <td>DF25</td> </tr> </tbody> </table>	REF	DT25C DT30C	DT55 DT65	DT75 DT85	DT115 DT140	V6 2-STROKE 1989-03	DF25 DF30	DF25	 <table border="1"> <thead> <tr> <th>REF</th> </tr> </thead> <tbody> <tr> <td>DT40C DF40 DF50 DF40A DF50A DF60A</td> </tr> <tr> <td>DF60 DF70</td> </tr> <tr> <td>DF60 DF70</td> </tr> <tr> <td>DF70A DF80A DF90A</td> </tr> </tbody> </table>	REF	DT40C DF40 DF50 DF40A DF50A DF60A	DF60 DF70	DF60 DF70	DF70A DF80A DF90A	 <table border="1"> <thead> <tr> <th>REF</th> </tr> </thead> <tbody> <tr> <td>DF90 DF100 DF115</td> </tr> <tr> <td>DF115A DF140</td> </tr> <tr> <td>DF150 DF175 DF200 DF225/ DF250</td> </tr> <tr> <td>DF250SS DF300</td> </tr> <tr> <td>DF250AP DF300AP</td> </tr> </tbody> </table>	REF	DF90 DF100 DF115	DF115A DF140	DF150 DF175 DF200 DF225/ DF250	DF250SS DF300	DF250AP DF300AP
REF																					
DT25C DT30C																					
DT55 DT65																					
DT75 DT85																					
DT115 DT140																					
V6 2-STROKE 1989-03																					
DF25 DF30																					
DF25																					
REF																					
DT40C DF40 DF50 DF40A DF50A DF60A																					
DF60 DF70																					
DF60 DF70																					
DF70A DF80A DF90A																					
REF																					
DF90 DF100 DF115																					
DF115A DF140																					
DF150 DF175 DF200 DF225/ DF250																					
DF250SS DF300																					
DF250AP DF300AP																					

**FUELLES VARILLA DE CAMBIO**      **SHIFT, BELOW**

REF	OEM
REC25222-93901	25222-93901



DF4, DF5, DF6 (2002-12)  
DF9.9, DF15 (1996-12)  
DT7, DT5 (1988-01)  
DT9.9, DT15 (1986-04)



*new*

**MANICOTTO MARCE**      **SOUFFLET DU LEVIER DE CHANGEMENT DE VITESSE**

REF	OEM
REC25222-96300	25222-96300



DF25, DF30 Y-K6 (2000-06)  
DT20, T25, DT30 (1986-02)  
DT40C-W G-X (1986-99)



*new*

**ARO TÓRICO VARILLA DE CAMBIO**      **SHIFT, O-RING**

REF	OEM
REC09280-08005	09280-08005

1,8 x 7.7 mm



DF20R, DF25RVZ (2006-13)  
DF25, DF30Y-K6 (2000-06)  
DF40, DF50X-K10 (1999-10)  
DF40A, DF50A, DF60A (2010+)  
DT20, DT25, DT30G-Y (1986-00)  
DT25, DT30 K1-K2 (2001-02)  
DT40C-W G-X (1986-99)  
DT55, DT60J-Z (1988-99)  
DT75, DT85J-Y (1988-00)



*new*

**O-RING MARCE**      **JOINT TORIQUE DU LEVIER**

REF	OEM
REC09280-11005	09280-11005 09280-11001

2.4 x 10.8 mm



DF40, DF50X-K10 (1999-10)  
DF40A, DF50A, DF60A (2010+)  
DF70A, DF80A, DF90A (2009+)  
DF100B (2018+)  
DT40C-W G-X (1986-99)  
DT4W K1-K4 (2001-04)  
DT55, DT65J-X (1988-99)  
DT75, DT85J-Y (1988-00)



*new*

**TUERCA VARILLA DE CAMBIO**      **TURNBUCKE CLUTCH ROD**

REF	OEM
REC23311-95DL0	23311-95DL0



DF25, DF30Y-K6 (2000-06)  
DF40, DF50X-K10 (1999-10)  
DF9.9, DF15T-K3 (1996-03)  
DF9.9, DF15 (R) (2004-11)  
DT9.9, DT40



**DADO ASTA CAMBIO**      **ECROU DU LEVIER DE CHANGEMENT DE VITESSE**



**TUBO DRENAJE  
BOMBA DE AGUA**

**DRAIN EATER TUBE**

**TUBO DRENAGGIO ACQUA**

**TUBE DE VIDANGE DE  
LA POMPE A EAU**

REF	OEM
REC17453-93901	17453-93900 17453-93901



**new**

DT15C (1989-97)  
DT9.9, DT15 K1-K4 (2001-04)  
DT9.9K, DT15K G-Y (1986-00)  
DF15 (2012)  
DF9.9, DF15T-K3 (1996-03)  
DF9.9, DF15(R) (2004-11)

REF	OEM
REC17560-91L00	17560-91L00 17560-96304 17560-96301 17560-96300

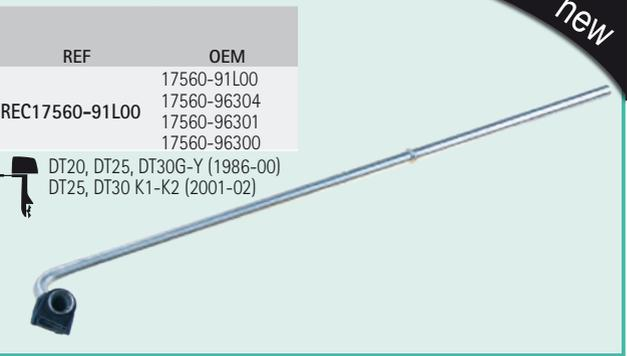

**new**

DT20, DT25, DT30G-Y (1986-00)  
DT25, DT30 K1-K2 (2001-02)

REF	OEM
REC17431-92L20	17431-92L20 17431-94441 17431-94440



**new**

DT40C-W G-X (1986-99)  
DT40W K1-K4 (2001-04)

**TORNILLOS Y JUNTAS DE  
DRENAJE**

**DRAIN, SCREW AND  
GASKETS**

**VITI E GUARNIZIONE,  
DRENAGGIO**

**VIS ET JOINTS DE VIDANGE**

REF	OEM
REC09248-10008	09248-10008 10 x 7.2 mm



**new**

REF	OEM
REC55128-93J10	55128-93J00 55128-93J10



**new**

DF70 --> DF300

REF	OEM
REC09168-10034	09168-10034



**new**

DF70 --> DF350

REF	OEM
REC59178-97J00	59178-97J00



**new**

DF2.5 --> DF30

**DIÁBOLO**

**DIABOLO**

**DIABOLO**

**DIABOLO**

REF	OEM
REC56120-93900	56120-93900-OEP 56120-93901-OED 56120-93900-002M 56120-90L00-OEP 56120-90L01-OEP 56120-90L02-OEP



**new**

DF9.9, DF15T-K3 (1996-03)  
DF9.9, DF15(R) (2004-12)  
DT9.9, DT15K1-K4 (1986-04)  
DT15 (1989-97)

REF	OEM
REC56120-96332-OEP	56120-96332-OEP



**new**

DF20R, DF25, DF25RVZ (2006-11)  
DF25, DF30Y-K6 (2000-06)  
DT25, DT30K1-K2 (2001-02)

REF	OEM
REC56120-94321-OEP	56120-94321-OEP



**new**

DF40, DF50X-K10 (1999-10)  
DF40A, DF50A, DF60A (2010-16)  
DT40W-K1-K4 (2001-04)

**ARO TÓRICO DEL DIÁBOLO DIABOLO, O-RING**

**O-RING DIABOLO**

**JOINT TORIQUE DU  
DIABOLO**

REF	OEM
REC09280-57002	09280-57002 3.5 x 65.2 mm



**new**

DF15 (2012)  
DF8A, DF9.9A (AR) (2010+)  
DF9.9, DF15T-K3 (1996-03)  
DF9.9, DF15(R) (2004-11)  
DF9.9B, DF15A, DF20A (2013+)  
DT15C (1989-97)  
DT9.9, DT15 K1-K4 (2001-04)  
DT9.9K, DT15K-G (1986-00)

REF	OEM
REC09280-75001	09280-75001 3.3 x 75 mm

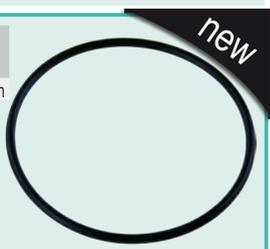

**new**

DF40, DF50X-K10 (1999-10)  
DF40A, DF50A, DF60A (2010+)  
DT40C-W G-X (1986-99)  
DT40W K1-K4 (2001-04)

# SELECTOR

# CLUTCH DOGS

# SELETTORE

# CRABOT

## SELECTOR

## CLUTCH DOGS

## SELETTORE

## CRABOT

REF	OEM
REC57621-94403	57621-94400 57621-94403 57621-87J03 57621-87J00 57621-87J01 57621-87J02
	DT40C-W G-X (1986-99) DT40W K1-K4 (2001-04) DF40, DF50X-K10 (1999-10) DF40A, DF50A, DF60A (2010+)



REF	OEM
REC57621-91L10	57621-91L10 57621-96300 57621-96310
	DT20, DT25, DT30G-Y (1986-00) DT25, DT30K1-K2 (2001-02) DT25C, DT30C K-Y (1989-00) DF25A, DF30A (2015)

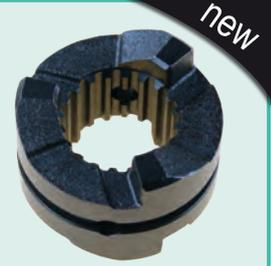

## MUELLE PARA SELECTOR

## SPRING CLUTCH

## MOLLA SELETTORE

## RESSORT DE SELECTEUR

REF	OEM
REC09440-32008	09440-32008
	DF9.9, DF15TK3 (1996-03) DF9.9, DF15(R) (2004-11) DF15 (2012) DT15C (1989-97) DT9.9, DT15 K1-K4 (2001-04) DT9.9K, DT15K G-Y (1986-00)



REF	OEM
REC09440-08043	09440-08043
	DF40, DF50X-K10 (1999-10) DF40A, DF50A, DF60A (2010+)



REF	OEM
REC09440-40002	09440-40002
	DF40, DF50X-K10 (1999-10) DF40A, DF50A, DF60A (2010+) DT40C-W G-X (1986-99) DT40W K1-K4 (2001-04) DT55, DT60J-X (1988-99)



REF	OEM
REC09440-05027	09440-05027
	DF9.9, DF15T-K3 (1996-03) DF9.9, DF15(R) (2004-11) DT15C (1989-97) DT8, DT9.9C J-V (1988-97) DT9.9, DT15 K1-K4 (2001-04) DT9.9, DT15K G-Y (1986-00)



## PIN

## PIN

## SPINOTTO

## PIN

REF	OEM
REC57632-97L00	57632-97L00 57632-98500 57632-98501
	DF15 (2012) DF4, DF5, DF6 (2002-15) DF8A, DF9.9A (AR) (2010+) DF9.9, DF15T-K3 (1996-03) DF9.9, DF15(R) (2004-11) DT15C (1989-97) DT4-J4, DT5Y (1988-00) DT5, DT6, DT8G-Y (1986-00) DF9.9B, DF15A, DF20A (2013+)



REF	OEM
REC09202-05022	09202-05022
	DF40, DF50X-K10 (1999-10) DF40A, DF50A, DF60A (2010+) DT40C-W G-X (1986-99) DT40W K1-K4 (2001-04)



## PASADOR PARA SELECTOR

## CLUTCH PIN

## PIN SELETTORE

## PIVOT

REF	OEM
REC57634-88L00	57634-88L00
	DF40, DF50X-K10 (1999-10) DF40A, DF50A, DF60A (2010+)



REF	OEM
REC09209-08016	09209-08016
	DF20R, DF25, DF25RVZ (2006-13) DF25, DF30Y-K6 (2000-06) DF25A, DF30A (2015+) DT20, DT25, DT30G-Y (1986-00) DT25, DT30 K1-K2 (2001-02) DT25C, DT30C K-Y (1989-00)



**VARILLA PARA SELECTOR**    **ROD PUSH**    **ASTA PRESSIONE**    **TIGE DE POUSSEE**

REF	OEM
REC57631-93901	57631-93901



*new*

 DF15 82012)  
 DF8A, DF9.9A 8AR) (2010+)  
 DF9.9, DF15(R) (2004-11)  
 DF9.9B, DF15A, DF20A (2013+)  
 DT15C (1989-97)  
 DT9.9, DT15 K1-K4 (2001-04)  
 DT9.9K, DT15K G-Y (1986-00)

REF	OEM
REC57631-95303	57631-95303
	57631-94700
	57631-95302
	57631-95301



*new*

 DF40, DF50X-K10 (1999-10)  
 DF40A, DF50A, DF60A (2010+)  
 DT40C-W G-X (1986-99)  
 DT40W K1-K4 (2001-04)  
 DT55, DT65J-X (1988-99)

REF	OEM
REC57631-96301	57631-96301



*new*

 DF25, DF30Y-K6 (2000-06)  
 DT20, DT25, DT30G-Y (1986-00)  
 DT25, D30 K1-K2 (2001-02)  
 DT25C, DT30C K-Y (1989-00)

**EXTREMO PARA SELECTOR**    **ARM, CLUTCH**    **HEBEL**    **EMBOUT DE SELECTEUR**

REF	OEM
REC23211-94401	



 DT25C, DT30C-K-Y (1989-00)  
 DT40C-W G-X (1986-99)  
 DT40W-K1K4 (2001-04)

**RODAMIENTOS**    **BEARING**    **CUSCINETTO**    **ROULEMENT**

**BOMBA DE ACEITE**    **OIL PUMP**    **POMPA OLIO**    **DE POMPE À HUILE**

REF	OEM
REC08110-60020	08110-60020



*new*

 DF150 --> DF350

**BOMBA DE AGUA**    **WATER PUMP**    **POMPA ACQUA**    **ROULEMENT DE POMPE À EAU**

REF	OEM
REC09263-25062	09263-25062



*new*

 DF40, DF40X-K10 (1999-10)  
 DT40C-W G-X (1986-99)  
 DT40W K1-K4 (2001-04)

REF	OEM
REC09263-25025	09263-25025
	09263-25048
	09263-25L02



*new*

**CIRCLIP,  
BOMBA DE AGUA**

CLIP

CLIP

CLIPS

REF	OEM
REC09380-15001	09380-15001

new

 DF8A, DF9.9A (AR) (2010+)  
 DF9.9B, DF15A, DF20A (2015+)  
 DT9.9, DT15 (1989-04)

**EJE TRANSMISIÓN  
SUPERIOR**

UPPER,  
DRIVE SHAFT

ALBERO DI TRASMISSIONE  
SUPERIORE

SUPERIEUR D'ARBRE DE  
TRANSMISSION

REF	OEM
REC08110-60020	08110-60020

new

 DF8 --> DF20  
 DT9.9, DT15

REF	OEM
REC09265-17002	09265-17002

new

 DT20R, DF25, DF25V2 (2006-13)  
 DF25, DF30Y-K6 (2000-06)  
 DF25A, DF30A (2015+)  
 DT20, DT25, DF30G-Y (1986-00)  
 DT25, DT30 K1-K2 (2001-02)  
 DT25C, DT30C K-Y (1989-00)

**EJE TRANSMISIÓN  
INFERIOR**

LOWER,  
DRIVE SHAFT

ALBERO DI TRASMISSIONE  
INFERIORE

INFERIEUR D'ARBRE DE  
TRANSMISSION

REF	OEM
REC09263-22L03	09263-22L03 09263-22039

new

 DF40A, DF50A, DF60A (2010-19)  
 DF40, DF50X-K10 (1999-10)  
 DT40C-W G-X (1986-99)  
 DT40W K1-K4 (2001-04)

REF	OEM
REC09263-20046	09263-20046

new

 DF20R, DF25, RVZ (2006-13)  
 DF25 (R) QVZ (2013)  
 DF255, DF30Y K-6 (200-06)  
 DF25A, DF30A (2015+)  
 DT20, DT25, DT30G-Y (1986-00)  
 DT25, DT30 K1-K2 (2001-02)  
 DT25C, DT30K-Y (1989-00)

REF	OEM
REC09263-15019	09263-15019

new

 DF15 (2012) 01503F  
 DF9.9, DF15T-K3 (1996-03)  
 DF9.9, DF15(R) (2004-11)  
 DT15C (1989-1997)  
 DT5, DT6, DT8 G-Y (1986-00)  
 DT6, DT8 Y-K2 (2000-02)  
 DT9.9, DT15 K1-K4 (2001-04)  
 DT9.9K, DT15K G-Y (1986-00)

**DIÁBOLO**

DIABOLO

DIABOLO

DE DIABOLO

REF	OEM
REC08110-60050	08110-60050

new

 DF8A, DF9A (2012+)  
 DF9.9, DF15 (1996-2012)  
 DF9.9B, DF15A, DF20A (2015+)  
 DT9.9, DT15 (1986-04)

REF	OEM
REC08113-60060	08113-60060

new

 DF25A, DF30A (2015+)  
 DF20R, DF25RVZ (2006-11)  
 DF25, DF30Y-K6 (2000-06)  
 DT20, DT25, DT30 (1986-02)

REF	OEM
REC09263-20047	09263-20047

new

 DF25A, DF30A (2015+)  
 DF25, DF30Y-K6 (2000-06)  
 DF25, DF25R, DF25QVZ (2013)  
 DF20R, DF25, DF25RVZ (2006-11)  
 DT20, DT25, DT30G-Y (1986-00)  
 DT25, DT30 K1-K2 (2001-02)  
 DT25C, DT30C K-Y (1989-00)

REF	OEM
REC09263-22020	09263-22020

new

 DF40A, DF50A, DF60A (2010+)  
 DF40, DF50X-K10 (1999-10)  
 DT40C-W G-X (1986-99)  
 DT40W K1-K4 (2001-04)  
 DT55, DT65 J-X (1988-99)

**PIÑÓN DE ATAQUE**

**INITIATIVE GEAR**

**PIGNONE ATTACCO**

**PIGNON D'ATTAQUE**

REF	OEM
REC09263-20L04	09263-20L04 09263-20024

 **new**

 DF8A /AR, DF9.9A/AR (2013-16)  
DF9.9B, DF15A, DF20A (2013-16)

REF	OEM
REC57311-99J10	57311-99J10

 **new**

 DF8A, DF9.9A (AR) (2012+)  
DF9.9B, DF15A, DF20A (2013+)

REF	OEM
REC57311-98600	57311-98601 57311-98600

 **new**

 DF4, DF5, DF6 (2002-11)  
DT4-J4, DT5Y (1988-00)  
DT4 K1 (2001)  
DT5Y (1998-02)

REF	OEM
REC57311-94402	57311-94401 57311-94402

 **new**

 DT40 (1986-04)

REF	OEM
REC57311-96311	57311-96310 57311-96311 57311-96320 57311-91L00

 **new**

 DT20, DT25, DT30 (1986-06)  
DF20, DF25 (RVZ) (2006-13)

REF	OEM
REC57311-93901	57311-93901

 **new**

 DT415C (1989-97)

REF	OEM
REC57311-93910	57311-93910 57311-90L00

 **new**

 DT9.9, DT15 (2001-04)  
DF9.9, DF15 (1996-04)

**PIÑÓN MARCHA AVANTE**

**POSITIVE GEAR**

**PIGNONE MARCIA AVANTI**

**PIGNON DE MARCHÉ AVANT**

REF	OEM
REC57510-91J00	57510-91J00 57510-98600 57510-98610 57510-98611

 **new**

 DT4/J4, DT5Y (1988-00)  
DT4 K1 (2001)  
DT5Y (1998-02)  
DF4, DF5, DF6 (2002+)

REF	OEM
REC57510-89J00	57510-89J00 57510-91L00

 **new**

 DT25, DT30 (2001-02)  
DF25, DF30 (2000-06)  
DF20R, DF25 (R) (VZ) (2006-13)

REF	OEM
REC57510-93902	57510-93902

 **new**

 DT15C (1989-97)

REF	OEM
REC57510-93910	57510-93910 57510-90L00

 **new**

 DT9.9, DT15 (2001-04)  
DF9.9, DF15 (1996-11)

REF	OEM
REC57510-94402	57510-94402 57510-94401 57510-94400

 **new**

 DT40 (1986-04)

## PIÑÓN MARCHA ATRÁS

## REVERSE GEAR

REF	OEM
REC57521-91J00	
 DF4, DF5, DF6 (2002-15) DT4/J4, DT5Y (1988-00) DT4K1 (2001) DT5Y (1998-02)	



REF	OEM
REC57521-93902	57521-93902 57310-93850
 DT15C (1989-97)	



REF	OEM
REC57521-94400	57521-94400 57310-94401
 DT40 (1986-04)	

PIGNONE MARCIA  
INDIETROPIGNON DE MARCHÉ  
ARRIERE

REF	OEM
REC57521-89J00	57521-89J00
 DF25, DF30 82000-06) DF20R, DF25 (R,Q) (VZ) (2006-13)	



REF	OEM
REC57521-93910	57521-93910 57521-90L00
 DF9.9, DF15 (1996-11) DT9.9, DT15 (2001-04)	



REF	OEM
REC57521-96312	57521-96312 57521-96311
 DT20, DT25, DT30 (1986-02)	



## ARANDELA / GRUESOS

## WASHER / SHIM

REF	OEM
REC09160-26015	09160-26015 26.2 x 42 x 4.0 mm
 DF40, DF50X-K10 (1999-10) DT40C-W G-X (1986-99) DT40W K1-K4 (2001-04)	



REF	OEM
REC09160-20027	09160-20027
 DF9.9 (2004-10) DT15, DF15 (1983-15) DF20 (2011-15) DF8A/AR, DF9.9A/AR (2010+) DF9.9B, DF15A, DF20A (2013+)	



REF	OEM
REC09160-20041	09160-20041 T: 1.0
 DT9.9 (1983-87) DT15 (1983-97)	



## RONDELLA / SPESSORE

## RONDELLE / CALE

REF	OEM
REC09160-21009	09160-21009 21 x 35 x 2.75 mm
 DF8A, DF8AR, DF9.9A, DF9.9AR (2010+) DF9.9, DF15T-K3 (1996-03) DF15 (2012) DF9.9, DF15(R) (2004-11) DF9.9B, DF15A, DF20A (2013) DT9.9K, DT15G-Y (1986-00) DT15C (1989-97) DT9.9, DT15K1-K4 (2001-04)	



REF	OEM
REC09160-20042	09160-20042 T:1.1
REC09160-20043	09160-20043 T:1.2
REC09160-20044	09160-20044 T:0.7
 DF8A, DF8AR, DF9.9A, DF9.9AR (2010+) DF9.9, DF15T-K3 (1996-03) DF15 (2012) DF9.9, DF15(R) (2004-11) DF9.9B, DF15A, DF20A (2013) DT9.9K, DT15G-Y (1986-00) DT15C (1989-97) DT9.9, DT15K1-K4 (2001-04)	





# SISTEMA DE PROPULSIÓN PROPULSION SYSTEM

# SISTEMA DI PROPULSIONE SYSTEME DE PROPULSION

HÉLICES ALUMINIO E INOXIDABLE DE 3 Y 4 PALAS	3 & 4 BLADE ALUMINIUM & SS PROPELLERS	ELICHE ALLUMINIO E INOX DA 3 E 4 PALE	HELICE ALUMINIUM ET INOX 3 ET 4 PALES
CÓDIGO DE REFERENCIAS	PART NO. CODING SYSTEM	SISTEMA DI CODICE	CODAGE DES REFERENCES
<p>1. Mercury, Mariner 2. Johnson, Evinrude 3. Yamaha 4. Suzuki 5. Tohatsu 6. 7. 8. Volvo Penta 9. Rubex System</p>	<p>0.5, 6, 8 and 9.8 HP Group 1. A Group 2. B Group 3. C Group 4. D Group 5. E Group 6. F Group 7. VP (Std. Hub) 8. VP (Long Hub)</p>	<p>1. AL 2. Saturn (INOX   Stainless Steel) 3. New Saturn (INOX   Stainless Steel) 4. Titan (INOX   Stainless Steel) 5. HR Titan (INOX   Stainless Steel) 6. Scorpion (INOX   Stainless Steel) 7. Lexor (INOX   Stainless Steel)</p>	<p>1. 3R Rubber Hub 2. 3L Rubber Hub 3. 4R Rubber Hub 4. 4L Rubber Hub</p>

## AMITA 3



Hélice de aluminio con núcleo de goma de gran resistencia.

Aluminum propeller with heavy duty rubber hub.

Eliche di alluminio con mozzi in gomma ad alta resistenza.

Hélice en aluminium avec moyeu en caoutchouc



## AMITA 4



Hélices de aluminio con núcleo de goma de gran resistencia. Van muy suaves a poca velocidad y hace el barco muy manejable con la mar picada.

Aluminum propeller with heavy duty rubber hub. Smoother low speed makes the offshore boating activity much easier.

Eliche di alluminio con mozzo in gomma ad alta resistenza. Molto morbido a bassa velocità e rende la barca molto maneggevole con mare cattivo.

Hélice en aluminium avec moyeu en caoutchouc. Permet d'aller doucement à basse vitesse et rende le bateau très maniable lorsque la mer est agitée



## LEXOR



Hélices de acero inoxidable. Gran diámetro del área de las palas para barcos pesados. Gran rendimiento en alta velocidad sin sacrificar las velocidades medias. Excelente ahorro de combustible.

Stainless steel propeller. Large diameter and blade area for big boat loads. Great high speed performance without sacrificing mid-range speeds. Excellent fuel economy.

Eliche di acciaio inox. Grande diametro delle pale per imbarcazioni pesanti. Grandi prestazioni ad alta velocità senza sacrificare velocità medie. Eccellente risparmio di carburante.

Hélice inox, grand diamètre pour bateaux lourds. Excellentes performances à grande vitesse sans sacrifier les vitesses moyennes. Excellente économie de carburant.



## NEW SATURN



Hélices de acero inoxidable. Ofrece buena aceleración y rendimiento. Tamaño más pequeño que ofrece un diámetro extragrande.

Stainless steel propeller. Offers good acceleration & all-round performance. Smaller pitch sizes offered in extra large diameter with increased blade area.

Eliche di acciaio inox. Buona accelerazione. Piccole dimensioni che offre un più grande diametro.

Hélice inox, offrant de bonnes accélérations et performances. Taille de pas réduite pour les modèles de grands diamètres avec une surface de pale plus importante.

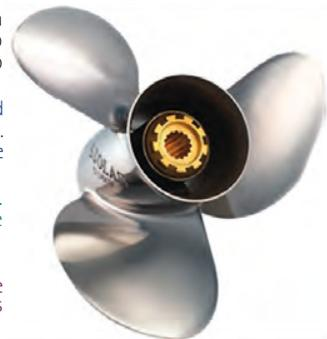

## HR TITAN 3 PROP



Hélice de acero inoxidable. Alto rendimiento para cascos de alta velocidad. La inclinación de la hoja proporciona un excelente elevación de proa y aceleración. El diseño de copa grande aumenta la mordida y reduce el deslizamiento.

Stainless steel propeller. Performance prop for high speed planning hulls. High rake blade design provides excellent bow lift and acceleration. Heavy cup design increases bite and reduces slip.

Eliche in acciaio inox. Alte prestazioni per scafi ad alta velocità. Il passo della pala fornisce un'eccellente spinta e accelerazione. Il disegno aumenta le prestazioni.

Hélice en acier inoxydable. Hélice de performance pour les coques de planification à grande vitesse. La conception de la lame à haut râteau offre une excellente portance et accélération de l'arc. La conception lourde de la tasse augmente la morsure et réduit le glissement.



GUÍA DE HÉLICES  
CON NÚCLEO INTEGRADO

PROPELLERS APPLICATION  
WITH RUBBER HUB

GUIDA ELICHE  
CON MOZZO

GUIDE DES HELICES ET  
MOYEURS

 2T STROKES 4T STROKES R.O. OEM	A B D P R					AL		INOX STAINLESS STEEL			
	AMITA 3		AMITA 4		NEW SATURN	LEXOR	HR TITAN 3				
DF4											
DF5	✓										
DF6 (2004+)		58110-91JN0-019	10	3	8	7	R	SOL4011-079-07S			
DT9.9 (1983-97)		58100-89L00-019				7		SOL4111-093-07A			
DT15 (1983-97)		58100-90L41-019				8		SOL4111-093-08A			
DF8 (2010+)	✓	58100-89L20-019	10	3	9,25	9	R	SOL4111-093-09A			
DF9.9 (1996+)		58100-89L60-019				10		SOL4111-093-10A			
DF15 (1996+)		58100-89L70-019				11		SOL4111-093-11A			
DF20 (2013+)		58100-89L50-019				12		SOL4111-093-12A			
DT20		58100-96410-019			10 <sup>1/4</sup>	10		SOL4211-110-09			
DT25/C		58100-96420-019				11		SOL4211-105-11			
DT30/C		58100-96430-019				12		SOL4211-103-12			
DF25	✓	58100-96440-019	10	3		13	R	SOL4211-101-13			
DF30		58100-95D00-019				14		SOL4211-100-14			
Thru-Hub		58100-96460-019				15		SOL4211-100-15			
DT35		58100-94302-019			11 <sup>1/2</sup>	9		SOL4311-121-09			
DT40		58100-95212-019			11 <sup>1/2</sup>	10		SOL4311-120-10			
DT50		58100-95222-019			11 <sup>1/2</sup>	11		SOL4311-118-11			
DT55		58100-95393-019	13	3	11 <sup>5/8</sup>	12	R	SOL4311-116-12			
DT60	✓	58100-94313-019			11 <sup>1/2</sup>	13		SOL4311-116-13			
DT65		58100-95353-019			11 <sup>3/8</sup>	14		SOL4311-116-14			
DF40		58100-95363-019			11	15		SOL4311-110-15			
DF50					14	11		SOL4411-140-11			
DF60					13 <sup>3/4</sup>	13		SOL4411-138-13	SOL4413-133-13		
DF70		58100-94500-019			13 <sup>1/2</sup>	15	V1500	SOL4411-135-15	SOL4413-130-15	SOL4431-135-15	
DF80		58100-94512-019			13 <sup>1/4</sup>	17	V1700	SOL4411-133-17	SOL4413-128-17	SOL4431-133-17	
DF90		58100-94522-019			13	19	V1900	SOL4411-130-19	SOL4413-125-19	SOL4431-130-19	
DF100		58100-94532-019			13	21	V2100	SOL4411-130-21	SOL4413-125-21	SOL4431-130-21	
DF115		58100-95511-019			13 <sup>1/4</sup>	17	U1700			SOL2431-135-15	
DF140	✓	58100-95521-019			13	19	U1900			SOL2431-133-17	
DF60		58100-95530-019	13	3	13	21	R U2100			SOL2431-130-19	
DF70		58100-94554-019			13 <sup>1/2</sup>	15				SOL4431-135-15	
DF70 (1998-08)		58100-94581-019			13 <sup>1/4</sup>	17				SOL4431-133-17	
Thru-hub		58100-94561-019			13	19				SOL4431-130-19	
		58100-94571-019			13	21				SOL4431-130-21	
		99105-00100-16P			13 <sup>1/4</sup>	16				SOL4431-135-15	
		99105-00100-18P			13 <sup>1/4</sup>	18				SOL4431-133-17	
		99105-00100-20P			13 <sup>1/4</sup>	20				SOL4431-130-19	
		99105-00100-22P			13 <sup>1/4</sup>	22				SOL4431-130-21	
DF70A		58100-90J40-019			15	15	R		SOL3413-138-15		
DF80A		58100-90J00-019			14 <sup>3/4</sup>	17	R	SOL3411-139-17	SOL3413-138-17		SOL3451-139-17
DF90		58100-90J10-019			14 <sup>1/2</sup>	19	R	SOL3411-139-19	SOL3413-138-19		SOL3451-139-19
DF115		58100-90J20-019			14 <sup>1/4</sup>	21	R	SOL3411-139-21	SOL3413-138-21		SOL3451-139-21
DF140	✓	58100-90J22-019			14	23	R				SOL3451-139-23
Thru-hub		99105-00700-18P				18	R				SOL3451-139-17
		99105-0070L-18P	15	3		18	L				SOL3452-139-17
		99105-00700-20P				20	R				SOL3451-139-19
		99105-0070L-20P				2	L				SOL3452-139-19
		99105-00700-22P				22	R				SOL3451-139-21
		99105-0070L-22P				22	L				SOL3452-139-21
		99105-00700-24P				24	R				SOL3451-139-23

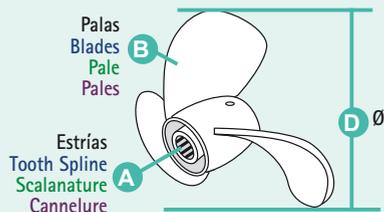

- P** Paso  
Pitch  
Passo  
Pas
- R** Rotación L (izquierda) R (derecha)  
Rotation L (left) R (Right)  
Rotazione L (SX) R (DX)  
Rotation L (gauche) R (droit)

	2T STROKES	4T STROKES	R.O. OEM	A B D P R					AL		INOX STAINLESS STEEL		
				AMITA 3		AMITA 4		NEW SATURN	LEXOR	HR TITAN 3			
DT150 DT175 DT200 DT225			58200-87D61-019	14 <sup>1/2</sup>	16	R			SOL4513-148-15			SOL4551-148-16	
			58200-87D62-019	14 <sup>1/2</sup>	16	L						SOL4552-148-16	
			58200-87D01-019	14 <sup>1/2</sup>	18	R			SOL4513-145-17			SOL4551-148-18	
			58200-87D02-019	14 <sup>1/2</sup>	18	L						SOL4552-148-18	
			58200-87D11-019	14 <sup>1/2</sup>	20	R			SOL4513-143-19			SOL4551-148-20	
			58200-87D12-019	14 <sup>1/2</sup>	20	L						SOL4552-148-20	
			58200-87D21-019	14 <sup>1/2</sup>	22	R			SOL4513-140-21			SOL4551-143-22	
			58200-87D22-019	14 <sup>1/2</sup>	22	L						SOL4552-143-22	
	Thru-hub			99105-00200-16P	15-14 <sup>1/4</sup>	15-16	R			SOL4511-150-15			SOL4551-148-16
				99105-0020L-16P	15-14 <sup>1/4</sup>	15-16	L			SOL4512-150-15			SOL4552-148-16
				99105-00200-18P	14.8-14 <sup>1/4</sup>	18	R			SOL4511-148-17			SOL4551-148-18
				99105-0020L-18P	14.8-14 <sup>1/4</sup>	18	L			SOL4512-148-17			SOL4552-148-18
				99105-00200-20P	14.5-14 <sup>1/4</sup>	20	R			SOL4511-145-19			SOL4551-148-20
				99105-0020L-20P	14.5-14 <sup>1/4</sup>	20	L			SOL4512-145-19			SOL4552-148-20
				99105-00200-22P	14.3-14 <sup>1/4</sup>	22	R			SOL4511-143-21			SOL4551-143-22
			99105-0020L-22P	14.3-14 <sup>1/4</sup>	22	L			SOL4512-143-21			SOL4552-143-22	
			99105-00200-24P	14.2-14 <sup>1/4</sup>	23-24	R			SOL4511-142-23			SOL4551-140-24	
			99105-0020L-24P	14.2-14 <sup>1/4</sup>	23-24	L			SOL4512-142-23			SOL4552-140-24	
DF150 DF175 DF200 DF225 DF250 DF300				99105-00200-16P	15.8	15	R			SOL4511-150-15			
					15.8	15	L			SOL4512-158-15			
				99105-00200-18P	15.5	17	R			SOL4511-155-17			
					15.5	17	L			SOL4512-155-17			
					15 <sup>3/8</sup>	18	R						SOL4571-154-18
				15 <sup>3/8</sup>	18	L						SOL4572-154-18	
			99105-00200-20P	15.3	19	R			SOL4511-153-19				
				15.3	19	L			SOL4512-153-19				
				15 <sup>1/8</sup>	20	R						SOL4571-151-20	
				15 <sup>1/8</sup>	20	L						SOL4572-151-20	
			99105-00200-22P	15.3	21	R			SOL4511-153-21				
				15.3	21	L			SOL4512-153-21				
				14 <sup>7/8</sup>	22	R						SOL4571-149-22	
				14 <sup>7/8</sup>	22	L						SOL4572-149-22	
				14 <sup>3/4</sup>	23	R						SOL4571-148-23	
			14 <sup>3/4</sup>	23	L						SOL4572-148-23		

**NÚCLEO INTERCAMBIABLE INTERCHANGEABLE HUB MOZZO INTERCAMBIABILE MOYEU INTERCHANGEABLE**

	2T STROKES	4T STROKES	A	REF	
DT50, DT50M (1983-84)					
DT55 (1985-97)			13	SOLRBX-115	C
DT60 (1983-84)					
DT65 (1985-97)					
DF70A, DF80A, DF90A (2009+)	✓		15	SOLRBX-150	D
DF90, DF115 (2001+)	✓		15	SOLRBX-125	D
DF140 (2001+)	✓		15	SOLRBX-126	D
75-140 HP DF60, DF70 (1979+)			13	SOLRBX-110	D
DT150-225 HP (1986+)	✓		15	SOLRBX-104	E
DF150-300 HP	✓	✓			



**RUBEX**

HÉLICES PARA NÚCLEO INTERCAMBIABLE

PROPELLERS FOR INTERCHANGEABLE HUB

ELICHE PER MOZZO INTERCAMBIABILE

HELICES AVEC MOYEU INTERCHANGEABLE

	B	D	P	R	AL
<b>C</b> 30-75 HP	3	12.1	9	R	SOL9311-121-09
		12	10	R	SOL9311-120-10
		11.6	11	R	SOL9311-116-11
		11.4	12	R	SOL9311-114-12
		11.1	13	R	SOL9311-111-13
		11.1	14	R	SOL9311-111-14
		11	15	R	SOL9311-110-15
<b>D</b> 40-140 HP	3	14	9	R	SOL9411-140-09
		14	11	R	SOL9411-140-11
		13.75	13	R	SOL9411-138-13
		13.50	15	R	SOL9411-135-15
		13.25	17	R	SOL9411-133-17
		13.2	19	R	SOL9411-132-19
		13.2	21	R	SOL9411-132-21
<b>E</b> 135-350 HP	3	15.5	11	R	SOL9511-155-11
		15.3	13	R	SOL9511-153-13
		16	13	R	SOL9511-160-13
		15	15	R	SOL9511-150-15
		15	15	L	SOL9511-150-15
		14.8	17	R	SOL9511-148-17
		14.8	17	L	SOL9511-148-17
		14.5	19	R	SOL9511-145-19
		14.5	19	L	SOL9511-145-19
		14.3	21	R	SOL9511-143-21
		14.3	21	L	SOL9511-143-21

	B	D	P	R	INOX STAINLESS STEEL
<b>C</b> 30-75 HP	3	11 5/8	11	R	SOL9331-116-11
		11 3/8	12	R	SOL9331-114-12
		11 1/8	13	R	SOL9331-111-13
		11 1/8	14	R	SOL9331-111-14
		11	15	R	SOL9331-110-15
		13 3/4	13	R	SOL9431-138-13
		13 3/4	13	L	SOL9432-138-13
<b>D</b> 40-140 HP	3	13 1/2	15	R	SOL9431-135-15
		13 1/2	15	L	SOL9432-135-15
		13 1/4	17	R	SOL9431-133-17
		13 1/4	17	L	SOL9432-133-17
		13	19	R	SOL9431-130-19
		13	19	L	SOL9432-130-19
		13	21	R	SOL9431-130-21
<b>E</b> 90-140 HP	3	14 1/2	15	R	SOL9531-145-15
		14 1/2	15	L	SOL9532-145-15
		14 1/4	17	R	SOL9531-143-17
		14 1/4	17	L	SOL9532-143-17
		14	19	R	SOL9531-140-19
		14	19	L	SOL9532-140-19
		14	21	R	SOL9531-140-21
		14	21	L	SOL9532-140-21
		14	23	R	SOL9531-140-23
		14	23	L	SOL9532-140-23
		<b>E</b> 135-350 HP	3	15 3/4	15
15 3/4	15			L	SOL9572-158-15
15 1/2	17			R	SOL9571-155-17
15 1/2	17			L	SOL9572-155-17
15 1/4	19			R	SOL9571-153-19
15 1/4	19			L	SOL9572-153-19
15	21			R	SOL9571-150-21
15	21			L	SOL9572-150-21
14 3/4	23			R	SOL9571-148-23
14 3/4	23			L	SOL9572-148-23
14 1/2	25			R	SOL9571-145-25
14 1/2	25	L	SOL9572-145-25		

**RUBEX**



Núcleo intercambiable (no incluido).  
Interchangeable hub (not included).  
Mozzo intercambiable (non incluso).  
Moyeu interchangeable (non inclus)

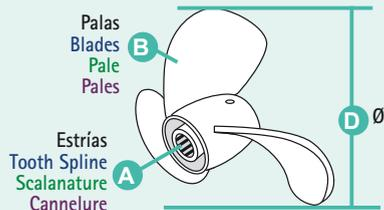

**P** Paso  
Pitch  
Passo  
Pas

**R** Rotación L (izquierda) R (derecha)  
Rotation L (left) R (Right)  
Rotazione L (SX) R (DX)  
Rotation L (gauche) R (droit)

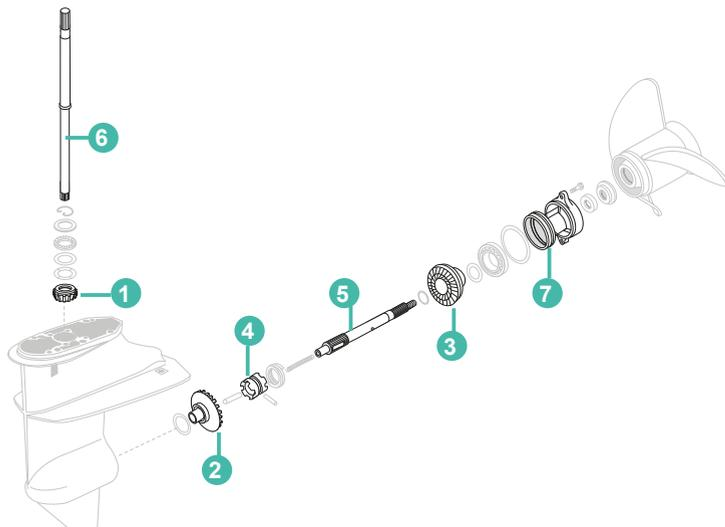

GUÍA PIEZAS DE COLA		STERN DRIVE COMPONENTS APPLICATIONS			GUIDA RICAMBI PIEDE		GUIDE DES PIÈCES D'EMBASE		
		1	2	3	4	5	6 L	6 S	7
DT2	1986-00	REC57311-98400							
DT2.2 K1-K5	2001-05	REC57311-98400							
DT9.9K DT15K-G-Y	1986-00	REC57311-93901	REC57510-93902	REC57521-93902		REC57610-93901	REC57100-93902	REC57110-93912	REC56120-93900
DT9.9 DT15K1-K4	2001-04	REC57311-93910	REC57510-93910	REC57521-93910		REC57610-93901	REC57100-93902	REC57110-93912	REC56120-93900
DF9.9 DF15T-K3	1996-03	REC57311-93910	REC57510-93910	REC57521-93910		REC57610-93901	REC57100-93902	REC57110-93912	REC56120-93900
DF9.9 DF15R	2004-11	REC57311-93910	REC57510-93910	REC57521-93910		REC57610-93901	REC57100-93902	REC57110-93912	REC56120-93900
DT15C	1989-97	REC57311-93901	REC57510-93902	REC57521-93902		REC57610-93901			REC56120-93900
DF15	2012					REC57610-93901	REC57100-93902	REC57110-93912	
DT20 DT25 DT30G-Y	1986-00	REC57311-96311	REC57510-89J00	REC57521-96312					
DT25C DT30C-K-Y	1989-00	REC57311-96311	REC57510-89J00	REC57521-96312					
DT25 DT30K1-K2	2001-02	REC57311-96320	REC57510-89J00	REC57521-89J00					
DF25 DF30Y-K6	2000-06	REC57311-96320	REC57510-89J00	REC57521-89J00					
DT40C-W G-X	1986-99	REC57311-94402	REC57510-94402	REC57521-94400			REC57110-94441	REC57110-94411	
DT40W K1-K4	2001-04	REC57311-94402	REC57510-94402	REC57521-94400			REC57110-94441	REC57110-94411	
DF40 DF50X-K10	1999-10								REC57621-94403

KIT CIERRE DE HÉLICE		PROPELLER NUT KIT		KIT CHIUSURA ELICA		KIT ECROU D'HELICE	
REF	OEM			REF	OEM		
REC57630-96300	57630-96300			REC57630-94300	57630-94300 57630-94301		
DF20R, DF25, DF25R V2 (2006-11) DF25, DF30Y-K6 (2000-06) DT20, DT25, DT30G-Y (1986-00) DT25, DT30K1-K2 (2001-02) DT25C, DT30C-K-Y (1989-00)				DF40, DF50X-K10 (1999-10) DF40A, DF50A, DF60A (2010+) DT40C-W G-X (1986-99) DT40W K1-K4 (2001-04) DT55, DT65J-X (1988-99)			
REC57630-94500	57630-94550			REC57630-92E00	57630-92E00		
DF40A, DF50A, DF60A (2014) DF60, DF70W-K9 (1998-09) DT75, DT85J-Y (1988-00) DT90, DT100L-Y (1990-00) DT115, DT140G-Y (1986-00) DF60, DF70 V-STYLE				DF150, DF175Z-T(G) (2006-14) DF200, DF225, DF250 (2004+) DF200A (20015+) DF300A-T-Z (2007-12) DF150, DT200, DT225W-K3 (1998-03) V6 H-Y (1987-00)			

## PASADOR DE HÉLICE

## PROPELLER PIN

## PIN ELICA

## CLAVETTE D'HELICE

REF	OEM
REC9202-04002	09202-04002

 **new**

DF2.5 (2006-13)  
DF4, DF5, DF6 (2002-11)  
DT2, DT2.2 G-Y (1986-00)  
DT4/J4 (1988-00)  
DT5Y (1988-02)

## PASADOR DE LA TUERCA DE HÉLICE

## COTTER PIN

## COPPIGLIA

## GOUPILLE D'ECROU D'HELICE

REF	OEM
REC91490-40030	09204-03003

 **new**

2.5 --> 350 HP

REF	OEM
REC9204-02004	09204-02004

 **new**

8 --> 20HP

REF	OEM
PAGB/T91-1.6X12	09204-02001

 **new**

DF2.5  
DT2, DT2.2HP

HÉLICE DE PLÁSTICO  
PLASTIC PROPELLER  
ELICA IN PLASTICA  
HELICE DE PLASTIQUE

## TUERCA DE HÉLICE

## PROPELLER NUT

## DADO DI ELICA

## ÉCROU D'HÉLICE

REF	OEM
REC09141-12005	09141-12005

 **new**

DF8A, DF9.9A (AR) (2010+)  
DF9.9, DF15T-K3 (1996-03)  
DF9.9, DF15(R) (2004-11)  
DF9.9B, DF15A, DF20A (2013+)  
DT15C (1989-97)  
DT9.9, DT15K1-K4 (2001-04)  
DT9.9K, DT15K G-Y (1986-00)

REF	OEM
REC90171-18M04	09141-18005

 **new**

40 --> 300 HP  
DT & DF

## SEPARADOR DE HÉLICE

## PROPELLER WASHER

## DISTANZIALE ELICA

## ENTRETOISE D'HELICE

REF	OEM
REC57632-94J00	57632-94J00

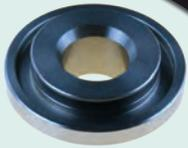
 **new**

DF8A, DF9.9A (AR) (2010+)  
DF9.9, DF15(R) (2004-11)  
DF9.9B, DF15A, DF20A (2013+)

TRASERO | BACK | POSTERIORE | ARRIERE

REF	OEM
REC57633-93901	57633-93901 57633-93900

 **new**

DF8A, DF9.9A (AR) (2010+)  
DF9.9, DF15(R) (2004-11)  
DF9.9B, DF15A, DF20A (2013+)

DELANTERO | FRONT | ANTERIORE | AVANT

# REF--> RO / OEM

REF	R.O. / OEM	
<b>C</b>		
CEF500312	17461-95201	469
CEF500319	17461-92D02	469
CEF500329	17461-93901	469
CEF500329	17461-93902	469
CEF500329	17461-93903	469-470
CEF500336	17461-98501	469
CEF500336	17461-98502	469
CEF500336	17461-98503	469-470
CEF500360	17461-95300	469
CEF500360	17461-95301	469
CEF500360	17461-95302	469
CEF500360	17461-95501	469
CEF500361	17461-94700	469
CEF500361	17461-94701	469
CEF500361	17461-95200	469
CEF500362G	17451-96301	469
CEF500362G	17461-96301	469
CEF500362G	17461-96310	469
CEF500362G	17461-96312	470
CEF500365	17461-87E10	470
CEF500365	17461-87E11	470
CEF500365	17461-87E12	469-470
CEF500367	17461-90J00	469
CEF500367	17461-90J01	469-470
CEF500367	17461-94510	469
CEF500393	17461-93J00	470
CEF500398	17461-93001	469
CEF500398	17461-93002	469
CEF500398	17461-93003	469
CEF500398	17461-93004	469
CEF500399	17461-96400	469
CM11130-94600	11130-94600	477-479
CM11130-94600A	11130-94600	477
CM41811-98500	41811-98500	476-501
CM5033167	41810-98500	439
CM55125-87D00	55125-87801	477
CM55125-87D00	55320-93900	477
CM55125-87D00A	55125-87801	477
CM55125-87D00A	55320-93900	477
CM55125-94400	55125-94400	511
CM55125-94502	55125-94502	477
CM55125-95301A	55125-95301	477
CM55125-95500	55125-87E01	477
CM55125-95500	55125-95500	509
CM55125-95500A	55125-87E01	477
CM55125-96310	55125-96310	477-505-507
CM55125-96310A	55125-96310	477
CM55300-95500	55300-95500	476-499-501-507-509-511
CM55300-95500A	55300-95500	476
CM55320-95310	55320-95310	476
CM55320-95310	55320-95311	517
CM55320-95310A	55320-95310	476
CM55320-98400	55320-98400	476
CM55320-98400A	55320-98400	476
CM55320-98600	55320-98600	477
CM55320-98600A	55320-98600	477
CM55321-87J00	55321-87J00	476-497-501-511
CM55321-87J00	55321-87J01	476-479-499-503
CM55321-87J00A	55321-87J00	476
CM55321-87J00A	55321-87J01	476
CM55321-87J00A	55321-87J01	439-440-441
CM55321-90J01	55321-90J01	477-512-515-516
CM55321-90J01A	55321-90J01	477
CM55321-93900	55320-93900	477
CM55321-93900	55321-93900	501
CM55321-93900A	55320-93900	477
CM55321-94900	55320-94900	476
CM55321-94900A	55320-94900	476
CM55321-94900A	55320-94900	441
CMSZ4050KITA		477
CMSZ90140KITA		477
CHAL90C		456
CHAQL78C		456
CHAQL82C		456
CHAQL82YC		456
CHAQL86C		456
CHAQL87YC		456
CHARA8HC		456
CHARC9YC		456
CHARN9YC		456
<b>G</b>		
GS11290		461
GS11291		461
GS11292		461
GS11294		461
GS30435		447
GS31001		447
GS31002		447
GS31035	65750-98505	444
GS31036	65750-98505	444
GS31037	65740-99100	444
GS31038	65720-94411	444
GS31039	65720-94403	444
GS31064		444
GS31065		447
GS31066		447
GS31067		447
GS31068		443
GS31069		443

REF	R.O. / OEM	
GS31070	65740-95D00	444
GS31071	65750-95500	444
GS31072	65750-95500	444
GS31089	65750-89J11	444
GS31090	65770-95504	442
GS31092		444
GS31095	65770-93J12	442
GS31096		442
GS31097		442
GS31099		442
GS31155		447
GS31156		447
GS31157		447
GS31166		447
GS31183		442
GS31187		442
GS31189		442
GS35031		442
GS35032		442
<b>L</b>		
LENS3213		445
LENS3227	99105-20005	446
<b>N</b>		
NGKB6HS		456
NGKB6HS-10		456
NGKB7HS		456
NGKB7HS-10		456
NGKB8HS		456
NGKB8HS-10		456
NGKBKR6E	09482-00427	439-440-441-455
NGKBP5HS		456
NGKBP6HS		456
NGKBPR5HS		456
NGKBPR6ES	09482-00299	439-440-455
NGKBPR6HS		456
NGKBPR7HS-10		456
NGKBR4HS		456
NGKBR5HS		456
NGKBR6HS		456
NGKBR6HS-10		456
NGKBR7HS		456
NGKBR7HS-10		456
NGKBR8HCS-10		456
NGKBR8HIX		456
NGKBR8HS		456
NGKBR8HS-10	94702-00271	456
NGKCRPR6EA-9	09482-00L04	439-440-455
NGKCR6E	09482-00528	439-455
NGKCR6HSA	09482-00406	439-455
NGKDCPR6E	09482-00446	440-455
NGKLR6E	09482-00649	455
NGKBR8HS-10	94702-00247-00	108
NGKBR8HS-10	94702-00271	247
NGKBR9HS-10	94701-00309-00	108
NGKBR9HS-10	94702-00309	245
NGKCR5HSB	94701-00300-00	108
NGKCR6HS	94701-00282	181
NGKCR6HS	94701-00282-00	108
NGKCR6HS	94702-00372-00	108
NGKCR6HSB	94702-00372	64-173-179
NGKCR9EB	94702-00409	108
NGKDPRE5EA-9	94701-00406-00	69-108
NGKDPRE6EA-9	94701-00375	197-207
NGKDPRE6EA-9	94701-00375-00	108
NGKDPRE6EA-9	94701-00375	65-66-67-68
NGKDPRE6EB-9	94702-00418	187-195-201-203
NGKDPRE6EB-9	94702-00418-00	108
NGKDPRE6EB-9	94702-00418	65-66-67-68-69
NGKDPRE7EA-9	94701-00375	185-191
NGKLFRA-11	94702-00391	209-211
NGKLFRA-11	94702-00391-00	108
NGKLFRA-11	94702-00391	69-70-71-72
NGKLFRA-11	94702-00400	213-214
NGKLFRA-11	94702-00400-00	108
NGKLFRA-11	94702-00400	70-72-73
<b>P</b>		
PAF15-0708000	15410-94400	447
PAF15-13010010W	67256-95600	466
PAF25-00000014	09202-08006	515-516-517-518
PAF25-07000007W	67275-95600	466
PAF4-04000030		443
PAF4-04090000	15100-91J00	450
PAF4-04090000	15100-91J01	450
PAF4-04090000	15100-91J02	450
PAF4-05000010		443
PAF40-0701000EI		446
PAF8-00000003	29116-93J10	513
PAGB/T5283-M6X25	09116-06229	497
PAGB/T5783-M6X12	09100-06130	515-516
PAGB/T5783-M6X14	09103-06281	476-477-478-479-497
PAGB/T5783-M6X16	09116-06225	497-512
PAGB/T5783-M8X16	09117-08037	507
PAGB/T5783-M8X16	09117-08109	509-511
PAGB/T5783-M8X25	09117-08057	515
PAGB/T5783-M8X30	09116-08151	499-503
PAGB/T5783-M8X30	09117-08047	501-509
PAGB/T5783-M8X55	09116-08117	501

REF	R.O. / OEM	
PAGB/T5787-1986	09116-08156	497
PAGB/T5787-M6X20	09116-06106	507
PAGB/T5787-M6X20	09116-06227	499-503
PAGB/T5787-M6X20	29116-93J00	501
PAGB/T5787-M6X30	09116-08122	505
PAGB/T6170-M6	29141-93J00	497-499-501-505-509-511
PAGB/T6184-2000	09141-06020	507
PAGB/T6184-2000	29141-93J00	503
PAGB/T8.8-2000	09125-05046	515-516
PAGB/T818-M4X30	09125-04023	512
PAGB/T818-M6X10	09125-06063	501-516
PAGB/T818-M6X14	09128-06221	479
PAGB/T820-M6X20	09126-06006	499-501
PAGB/T848-6	09160-06082	497-503-505
PAGB/T848-6	09162-06006	507
PAGB/T879.1-2.5X14	09202-02006	439
PAGB/T889.1-M4	09140-04007	512
PAGB/T896-6	57292-94300	466
PAGB/T91-1.6X12	09204-02001	439-532
PAGB/T93-6	29162-93J00	499-501-509-511
PAGB/T97.1-8		507
PAJASOF404-19-033	09280-33005	439
PH130-0006	31100-89J00	457
PH130-0006	31100-94400	457
PH130-0006	31100-944002	457
PH130-0006	31100-94401	457
PH130-0006	31100-95D00	457
PH130-0006	31100-96310	457
PH130-0006	31100-96311	457
PH130-0007	31100-95240	457
PH130-0007	31100-95242	457
PH130-0007	31100-95243	457
PH130-0052	31100-87000	457
PH130-0052	31100-87D00	457
PH130-0052	31100-87D10	457
PH130-0052	31100-92E00	457
PH130-0053	31100-94500	457
PH130-0053	31100-94510	457
PH130-0053	31100-94511	457
PH130-0053	31100-94512	457
PH130-0053	31100-94600	457
PH130-0053	31100-94601	457
PH130-0053	31100-94610	457
PH130-0060	31100-95310	457
PH130-0060	31100-95312	457
PH130-0060	31100-95313	457
PH130-0060	31100-95521	457
PH130-0060	31100-95600	457
PH130-0060	31100-95601	457
PH130-0071	31100-90J00	457
PH130-0071	31100-90J01	457
PH130-0075	31100-94702	457
PH130-0077	31100-94J10	457
PH130-0077	31100-94J20	457
PH130-0077	31100-94J21	457
PH130-0077	31100-94J22	457
PH130-0077	31100-95J00	457
PH130-0077	31100-95J01	457
PH130-0078	31100-93J00	458
PH130-0078	31100-96J00	458
PH130-0078	31100-96J01	458
PH130-0078	31100-98L00	458
PH130-0078	31100-98L10	458
PH130-0079	31100-87500	458
PH130-0079	31100-87J00	458
PH130-0079	31100-87J10	458
PH130-0079	31100-87J11	458
PH200-T024	38100-87D10-OED	462
PH200-T024	38100-87D10-OIT	462
PH200-T024	38100-87D10-35J	462
PH200-T024	38100-87E20-OED	462
PH200-T024	38100-92E00-OED	462
PH200-T027	48500-95550-OED	461
PH200-T027	48500-95680-OED	461
PH200-T046	38100-87J11	462
PH200-T046	38100-87J20	462
PH200-WH01		461
PRE3300C08	99105-11002-008	467
PRE3300C09	99105-11002-009	467
PRE3300C10	99105-11002-010	467
PRE3300C11	99105-11002-011	467
PRE3300C12	99105-11002-012	467
PRE3300C13	99105-11002-013	467
PRE3300C14	99105-11002-014	467
PRE3300C15	99105-11002-015	467
PRE3300C16	99105-11002-016	467
PRE3300C17	99105-11002-017	467
PRE3300C18	99105-11002-018	467
PRE3300C19	99105-11002-019	467
PRE3300C20	99105-11002-020	467
PRE3300C21	99105-11002-021	467
PRE3300C22	99105-11002-022	467
PRE3300C23	99105-11002-023	467
PRE3300C24	99105-11002-024	467
PRE3300C25	99105-11002-025	467
PRE3300C26	99105-11002-026	467
PRE3300C27	99105-11002-027	467
PRE3300C28		

REF	R.O. / OEM	
<b>RAC23289-10</b>		446
<b>RAC23299-10</b>		446
<b>RAC320R-RAC-01</b>		445
<b>RAC320R-RAC-03</b>		445
<b>RAC490R-RAC-01</b>	99105-20005-ASY	446
<b>RACPF5510</b>		445
<b>RACRK22628</b>	99105-20003	447
<b>RACS3213</b>		445
<b>RACS3227</b>	99105-20005	446
<b>REC08110-60020</b>	08110-60020	499-501-503-523-524
<b>REC08110-60050</b>	08110-60050	499-501-503-524
<b>REC08113-60060</b>	08113-60060	505-507-524
<b>REC09116-06094</b>	09116-06094	479-501-505-509-517
<b>REC09116-06094</b>	55321-93J00	479
<b>REC09116-06121</b>	09116-06121	479-505-507
<b>REC09116-06121</b>	09116-06229	499
<b>REC09116-06121</b>	55321-94900	479
<b>REC09141-12005</b>	09141-12005	503-532
<b>REC09160-12066</b>	09160-12066	503
<b>REC09160-20027</b>	09160-20027	499-503-526
<b>REC09160-20041</b>	09160-20041	501-503-526
<b>REC09160-20042</b>	09160-20042	499-501-503-526
<b>REC09160-20043</b>	09160-20043	499-501-503-526
<b>REC09160-20044</b>	09160-20044	499-501-503-526
<b>REC09160-20052</b>	09160-20052	491
<b>REC09160-21009</b>	09160-21009	499-501-503-526
<b>REC09160-26015</b>	09160-26015	509-526
<b>REC09160-27008</b>	09160-27008	480-491
<b>REC09168-10022</b>	09168-10022	490-497-501-505-507-509-511-512-515-516-439-440-441
<b>REC09168-10034</b>	09168-10034	513-517-518-521-440-441
<b>REC09168-12012</b>	09168-12012	439-440-441-449
<b>REC09168-12017</b>	09168-12017	439-440-449
<b>REC09181-24001</b>	09181-24001	491
<b>REC09202-04002</b>	09202-04002	509-532
<b>REC09202-05022</b>	09202-05022	511-522
<b>REC09204-02004</b>	09204-02004	439-499-503-532
<b>REC09209-08016</b>	09209-08016	505-507-522
<b>REC09248-10008</b>	09248-10008	497-501-505-507-509-511-512-513-515-516-521
<b>REC09262-25078</b>	09262-25003	503
<b>REC09262-25078</b>	09262-25078	490
<b>REC09262-30055</b>	09262-30055	490
<b>REC09262-35052</b>	09262-35052	480
<b>REC09263-14022</b>	09263-14014	492
<b>REC09263-14022</b>	09263-14022	491
<b>REC09263-15019</b>	09263-15019	501-524
<b>REC09263-18016</b>	09263-14022	491
<b>REC09263-20046</b>	09263-20046	505-507-524
<b>REC09263-20047</b>	09263-20047	505-507-524
<b>REC09263-20051</b>	09263-20051	491
<b>REC09263-20072</b>	09263-20072	480-491-492
<b>REC09263-20L04</b>	09263-20024	525
<b>REC09263-20L04</b>	09263-20L04	499-501-503-525
<b>REC09263-22020</b>	09263-22020	509-511-524
<b>REC09263-22L03</b>	09263-22039	509-511-524
<b>REC09263-22L03</b>	09263-22L03	524
<b>REC09263-24018</b>	09263-24018	491
<b>REC09263-25025</b>	09263-25025	509-523
<b>REC09263-25025</b>	09263-25048	523
<b>REC09263-25025</b>	09263-25L02	523
<b>REC09263-25062</b>	09263-25062	509-523
<b>REC09263-27005</b>	09263-27005	480-491
<b>REC09265-17002</b>	09265-17002	505-507-524
<b>REC09269-30012</b>	09269-30012	480-490
<b>REC09280-08005</b>	09280-08005	520
<b>REC09280-11005</b>	09280-11001	520
<b>REC09280-11005</b>	09280-11005	520
<b>REC09280-22019</b>	09280-22019	439-440-441-476-478-479
<b>REC09280-54001</b>	09280-54001	449
<b>REC09280-54001</b>	09280-56001	449
<b>REC09280-54001</b>	09280-54001	439
<b>REC09280-57002</b>	09280-57002	499-501-503-521
<b>REC09280-75001</b>	09280-75001	505-509-511-521
<b>REC09282-10008</b>	09282-10008	488-497
<b>REC09282-12008</b>	09282-12008	488
<b>REC09282-12010</b>	09282-12010	489
<b>REC09282-15008</b>	09282-15008	489
<b>REC09282-17005</b>	09282-17005	489-509-511
<b>REC09282-17009</b>	09282-17009	489
<b>REC09283-10003</b>	09283-10003	489
<b>REC09283-10009</b>	09283-10009	489
<b>REC09283-17002</b>	09283-17002	488
<b>REC09283-20018</b>	09283-20018	488
<b>REC09283-20045</b>	09283-20045	489

REF	R.O. / OEM	
<b>REC09283-25035</b>	09283-25035	489
<b>REC09283-25075</b>	09283-25075	489
<b>REC09283-25075</b>	09283-25075	489
<b>REC09283-30062</b>	09283-30062	480-489
<b>REC09283-30064</b>	09283-30064	489
<b>REC09283-35043</b>	09283-35043	480-489
<b>REC09289-10005</b>	09289-10005	489
<b>REC09289-12002</b>	09289-12002	489
<b>REC09289-12003</b>	09289-12003	490-501
<b>REC09289-17004</b>	09289-17004	489
<b>REC09289-17006</b>	09289-17006	489-501
<b>REC09289-17006</b>	09289-17L02	499-503
<b>REC09289-20009</b>	09289-20009	489-505-507
<b>REC09289-22007</b>	09289-22007	490-509-511
<b>REC09289-30008</b>	09289-30008	490
<b>REC09380-15001</b>	09380-15001	499-501-503-524
<b>REC09381-20003</b>	09381-20003	480
<b>REC09401-11425</b>	09401-11425	443
<b>REC09401-11425</b>	17822-90J00	443
<b>REC09401-11425BULK</b>	09401-11425	443
<b>REC09401-11425BULK</b>	17822-90J00	443
<b>REC09420-03002</b>	09420-03002	470-497
<b>REC09420-03005</b>	09420-03005	470-503
<b>REC09420-03005</b>	09420-03009	470-499
<b>REC09420-04006</b>	09420-04006	470-505-507-509-511
<b>REC09420-05009</b>	09420-05006	470
<b>REC09420-05009</b>	09420-05009	470-515-516-517-518-440-441
<b>REC09440-05027</b>	09440-05027	501-522
<b>REC09440-08043</b>	09440-08043	511-522
<b>REC09440-32008</b>	09440-32008	501-522
<b>REC09440-40002</b>	09440-40002	509-511-522
<b>REC10W30U3</b>		450
<b>REC10W30U6</b>		450
<b>REC10W40U3</b>	990C0-01E30-GLN	450
<b>REC10W40U3</b>	990C0-10W40-1GL	450
<b>REC10W40U3</b>	990C0-10W40-GAL	450
<b>REC10W40U3</b>	990C0-10W40-GLN	450
<b>REC10W40U6</b>	990C0-01E30-GLN	450
<b>REC10W40U6</b>	990C0-10W40-1GL	450
<b>REC10W40U6</b>	990C0-10W40-GAL	450
<b>REC10W40U6</b>	990C0-10W40-GLN	450
<b>REC11141-87D90</b>	11141-87D61	487
<b>REC11141-87D90</b>	11141-87D90	487
<b>REC11141-87D92</b>	11141-87D32	487
<b>REC11141-87E90</b>	11141-87D90	487
<b>REC11141-87E90</b>	11141-87E20	487
<b>REC11141-87J02</b>	11141-87J00	483-484
<b>REC11141-87J02</b>	11141-87J01	483-484
<b>REC11141-87J02</b>	11141-87J02	481-483-484
<b>REC11141-87L00</b>	11141-87L00	482-483-484
<b>REC11141-90J01</b>	11141-90J00	483
<b>REC11141-90J01</b>	11141-90J01	484
<b>REC11141-91J10</b>	11141-91J01	483-484
<b>REC11141-91J10</b>	11141-91J02	483-484
<b>REC11141-91J10</b>	11141-91J10	483-484
<b>REC11141-91J10</b>	11141-91J10	483-484
<b>REC11141-92J01</b>	11141-92J00	483-484
<b>REC11141-93960</b>	11141-93950	487
<b>REC11141-93E20</b>	11141-93E20	483-484
<b>REC11141-93J10</b>	11141-93J03	483-484
<b>REC11141-94450</b>	11141-94440	487
<b>REC11141-94450</b>	11141-94450	487
<b>REC11141-94506</b>	11141-94506	487
<b>REC11141-94506</b>	11141-94620	487
<b>REC11141-94720</b>	11141-94701	487
<b>REC11141-94720</b>	11141-94720	487
<b>REC11141-95505</b>	11141-95505	487
<b>REC11141-95505</b>	11141-95621	487
<b>REC11141-95D40</b>	11141-95D40	487
<b>REC11141-95J00</b>	11141-95J00	483-484
<b>REC11141-96303</b>	11141-96344	487
<b>REC11141-96344</b>	11141-96343	487
<b>REC11141-96344</b>	11141-96344	487
<b>REC11141-97J02</b>	11141-97J01	483
<b>REC11141-97J02</b>	11141-97J10	483-484
<b>REC11141-98130</b>	11141-98130	487
<b>REC11141-98401</b>	11141-98401	487
<b>REC11141-98401</b>	11141-98411	487
<b>REC11141-98J10</b>	11141-98J01	483-484
<b>REC11141-98J10</b>	11142-98J00	484
<b>REC11142-93J10</b>	11142-93J03	483-484
<b>REC11142-98J10</b>	11142-98J00	483
<b>REC11162-94410</b>	11162-94410	488
<b>REC11189-87J00</b>	11189-87J00	481-486
<b>REC11189-87L00</b>	11189-87L00	482-486
<b>REC11265-87E10</b>	11265-87E00	479
<b>REC11265-87E10</b>	11265-87E00-H17	479
<b>REC11265-87E10</b>	11265-87E10	481
<b>REC11400-87804</b>	11400-87800	484
<b>REC11400-87804</b>	11400-87801	484
<b>REC11400-87804</b>	11400-87802	484
<b>REC11400-87804</b>	11400-87803	484
<b>REC11400-87804</b>	11400-87804	481-484
<b>REC11410-87851</b>	11410-87850	484
<b>REC11410-87851</b>	11410-87851	482-484
<b>REC11413-87J00</b>	11413-87J00	481-486
<b>REC11433-87J00</b>	11433-87J00	481-486
<b>REC11433-93912</b>	11433-93901	488
<b>REC11433-94412</b>	11433-94401	488

REF	R.O. / OEM	
<b>REC11433-96330</b>	11433-96302	488
<b>REC11434-94411</b>	11434-94411	495
<b>REC11489-87J00</b>	11489-87J00	481-493
<b>REC11489-87L00</b>	11489-87L00	482-493
<b>REC11489-90J00</b>	11489-90J00	493
<b>REC11489-93E11</b>	11489-93E11	493
<b>REC11489-93J00</b>	11489-93J00	493
<b>REC11542-87L00</b>	11542-87L00	482-493
<b>REC11552-87L00</b>	11552-87L00	485
<b>REC12110-93130K</b>	12110-93130	492
<b>REC12110-94350K</b>	12110-94350	492
<b>REC12110-94400K</b>	12110-94400K	480-492
<b>REC12140-93121</b>	12140-93121	492
<b>REC12140-94400</b>	12140-94400	480-492
<b>REC12151-94400</b>	12151-94400	480
<b>REC12161-93902</b>	12161-93902	491
<b>REC12161-94400</b>	12161-94400	480-491
<b>REC12161-96300</b>	12161-96300	491
<b>REC12211-94410</b>	12211-94410	480
<b>REC12221-94412</b>	12221-94412	480-490
<b>REC12231-94413</b>	12231-94413	480-490
<b>REC12232-94412</b>	12232-94412	480-490
<b>REC12240-94432</b>	12240-94432	480-490
<b>REC12710-97J00</b>	12710-97J00	483
<b>REC12761-72F00</b>	12761-72F00	492
<b>REC12761-93E10</b>	12761-93E10	492
<b>REC12761-99J00</b>	12761-99J00	492
<b>REC12778-93J00</b>	12778-93J00	485
<b>REC13119-93J0</b>		



REF	R.O. / OEM	
REC16510-82703	16510-92J00	449
REC16510-87J00	16510-87J00	449
REC16510-87J00	16510-87J00	449
REC16510-87J00	16510-87J00	439-440-449
REC16510-90J00	16510-61A01	449
REC16510-90J00	16510-61A20-MHL	449
REC16510-90J00	16510-61A21-MHL	449
REC16510-90J00	16510-61A30	449
REC16510-90J00	16510-61A31	449
REC16510-90J00	16510-90J00	449
REC16510-90J00	16510-90J00	440-441-449
REC16510-93J00	16510-96J00	449
REC16510-93J00	16510-96J10	449
REC16510-93J00	16510-96J10	449
REC16510-96J00	16510-96J00	449
REC16510-96J00	16510-96J10	449
REC16510-96J00	16510-96J10	441
REC16539-87L00	16539-87L00	482-485
REC16910-GB2-005	15410-94350	448
REC17400-87810	17400-87810	440
REC17400-87820	17400-87820	440
REC17400-87D11	17400-87D00	474
REC17400-87D11	17400-87D10	474
REC17400-87D11	17400-87D11	474
REC17400-87D11	17400-87D11	476
REC17400-87E04	17400-87E03	440-474-476-512
REC17400-87L01	17400-87L00	475
REC17400-87L01	17400-87L01	475-513
REC17400-87L01	17400-87L01	440-476
REC17400-88810	17400-88810	440
REC17400-88L00	17400-88L00	440-475-476-511
REC17400-89810	17400-89810	439
REC17400-89820	17400-89820	440
REC17400-90J20	17400-90J11	475
REC17400-90J20	17400-90J20	476-515
REC17400-91830	17400-91830	439
REC17400-91860	17400-91860	439
REC17400-92821	17400-92821	441
REC17400-92840	17400-92840	440
REC17400-92850	17400-92850	441
REC17400-92D01	17400-92D01	474
REC17400-92D01	17400-92D11	474
REC17400-92D01	17400-92D01	476
REC17400-92J00	17400-92J200	475-476
REC17400-92J21	17400-92J21	440-441-475-476-515-516
REC17400-93851	17400-93851	441
REC17400-93912	17400-93911	475
REC17400-93912	17400-93912	475
REC17400-93951	17400-93950	474-501
REC17400-93951	17400-93951	476-501
REC17400-93J01	17400-93J00	474
REC17400-93J01	17400-93J01	474
REC17400-93J01	17400-93J02	474
REC17400-93J01	17400-93J01	441-476
REC17400-94611	17400-94611	475-476
REC17400-94701	17400-94700	474
REC17400-94701	17400-94701	474
REC17400-94701	17400-94701	476
REC17400-94810	17400-94810	439
REC17400-94821	17400-94821	440
REC17400-94J00	17400-94J200	439-476
REC17400-94L00	17400-94L00	440-475-476
REC17400-95351	17400-95350	474
REC17400-95351	17400-95351	474
REC17400-95351	17400-95550	474
REC17400-95351	17400-95351	476
REC17400-95870	17400-95870	439
REC17400-95J02	17400-95J01	476
REC17400-95J02	17400-95J02	439-476-505
REC17400-96403	17400-96350	474
REC17400-96403	17400-96351	474
REC17400-96403	17400-96352	474-507
REC17400-96403	17400-96353	509
REC17400-96403	17400-96403	440-474-476-509
REC17400-96821	17400-96821	441
REC17400-96J03	17400-96J00	475
REC17400-96J03	17400-96J01	475
REC17400-96J03	17400-96J02	475
REC17400-96J03	17400-96J03	441-475-476-517
REC17400-97810	17400-97810	439
REC17400-97820	17400-97821	439
REC17400-98551	17400-98551	474-476
REC17400-98652	17400-98652	474
REC17400-98652	17400-98661	474
REC17400-98652	17400-98652	476
REC17400-98661	17400-98661	474-497
REC17400-98661	17400-986L0	474
REC17400-98661	17400-986L1	474
REC17400-98661	17400-98661	439-476
REC17400-98861	17400-98861	441
REC17400-98J01	17400-98J00	474
REC17400-98J01	17400-98J01	474-518
REC17400-98J01	17400-98J02	441-474-476
REC17400-99840	17400-99840	439
REC17400-99870	17400-99870	440
REC17400-99J01	17400-99J00	475

REF	R.O. / OEM	
REC17400-99J01	17400-99J01	439-475-476-499-503
REC17411-93901	17410-93910	471
REC17411-93901	17411-93901	471-501
REC17411-94421	17410-94431	471
REC17411-94421	17411-94421	471-507-509
REC17413-92J01	17413-92J00	473
REC17413-92J01	17413-92J01	473-515-516
REC17413-95J00	17413-95J00	439-473-505-511
REC17413-96J01	17413-96J00	473
REC17413-96J01	17413-96J01	441-473-517
REC17413-99E11	17413-99E10	512-513
REC17413-99E11	17413-99E11	473
REC17416-92J00	17416-92J00	515
REC17416-92J10	17416-92J10	472-515-516
REC17416-93J00	17416-93J00	472-518
REC17416-95J00	17416-95J00	472-505-511
REC17416-96J00	17416-96J00	472-517
REC17416-99E10	17416-99E10	472-513
REC17417-92J00	17417-92J00	472-515
REC17431-92L20	17431-92L20	521
REC17431-92L20	17431-94440	521
REC17431-92L20	17431-94441	521
REC17450-93921	17450-93440	471
REC17450-93921	17450-93920	471
REC17450-93921	17450-93921	471-501
REC17450-93921	17450-93930	471
REC17452-93910	17452-93910	473-501
REC17453-93901	17453-93900	501-521
REC17453-93901	17453-93901	521
REC17461-87E12	17461-87E10	470
REC17461-87E12	17461-87E11	470
REC17461-87E12	17461-87E12	469-470-512-513
REC17461-90J01	17461-90J00	469
REC17461-90J01	17461-90J01	469-470-515-516-517
REC17461-90J01	17461-94510	469
REC17461-92D02	17461-92D02	469
REC17461-93004	17461-93001	469
REC17461-93004	17461-93002	469
REC17461-93004	17461-93003	469
REC17461-93004	17461-93004	469
REC17461-93903	17461-93901	469
REC17461-93903	17461-93902	469
REC17461-93903	17461-93903	469-470-501-503
REC17461-93903	17461-939M0	499
REC17461-93903	17461-93903	470
REC17461-93J00	17461-93J00	470-518
REC17461-94700	17461-94700	469
REC17461-94700	17461-94701	469
REC17461-94700	17461-95200	469
REC17461-94700	17461-95201	469
REC17461-95300	17461-95300	469
REC17461-95300	17461-95301	469
REC17461-95300	17461-95303	469
REC17461-95300	17461-95501	469
REC17461-96312	17451-96301	469
REC17461-96312	17461-94L00	470
REC17461-96312	17461-96301	469
REC17461-96312	17461-96310	469
REC17461-96312	17461-96312	470-505-507-509-511
REC17461-97J00	17461-97110	439-470
REC17461-98503	17461-98501	469
REC17461-98503	17461-98502	469
REC17461-98503	17461-98503	469-470
REC17461-98503	17461-985M0	470-497
REC17462-93990	17462-93990	470-501
REC17471-92J00	17471-87E00	471
REC17471-92J00	17471-87E01	471-512
REC17471-92J00	17471-92J00	471-515-516
REC17471-92J02	17471-92J00	471
REC17471-92J02	17471-93J01	471
REC17471-92J02	17471-93J02	471-517
REC17471-93902	17471-93902	471-501
REC17471-94401	17471-94401	471-507-509
REC17471-95J01	17471-95J00	471
REC17471-95J01	17471-95J01	471-505-511
REC17471-97J00	17471-97J00-00	439-471
REC17471-97J00	17471-97J00	439-471
REC17471-98601	17471-98600	471
REC17471-98601	17471-98601	471
REC17472-87E10	17472-87E00	472
REC17472-87E10	17472-87E10	472-512-515-516
REC17472-87L00	17472-87L00	472-482-513
REC17472-91J00	17472-91J00	473-497
REC17472-92D10	17472-92D10	473
REC17472-93911	17472-93911	473-501
REC17472-93J00	17472-93J00	473-517
REC17472-95310	17472-95310	473
REC17472-96303	17472-96301	472
REC17472-96303	17472-96302	472
REC17472-96303	17472-96303	472-481-505-507-509-511
REC17472-97J00	17472-97J00	439-472
REC17472-97J00	17472-97J00	439-472
REC17472-98503	17472-98503	473
REC17472-98611	17472-98611	473
REC17472-98J00	17472-98J00	472-518

REF	R.O. / OEM	
REC17560-91L00	17560-91L00	521
REC17560-91L00	17560-96300	521
REC17560-91L00	17560-96301	521
REC17560-91L00	17560-96304	521
REC17616-87J00	17616-87J00	468-481-486
REC17670-90J10	1770-90J10	468
REC17670-90J20	17670-90J20	468
REC17670-91J01	17670-91J00	468
REC17670-91J01	17670-91J01	468
REC17670-93962	17670-93962	468
REC17670-94402	17670-94402	468
REC17670-94J01	17670-94J00	468
REC17670-94J01	17670-94J01	468
REC17685-87D10	17685-87D00	486-488
REC17685-87D10	17685-87D10	481-486-488
REC17693-95J00	17693-95J00	485
REC17913-93J00	17913-93J00	469
REC17914-93J00	17914-93J00	469
REC17914-93J00	17914-93J00	469
REC18-6865	48600-94511-OED	462
REC18137-52D00	18137-52D00	452-454
REC18137-87L01	18137-87L01	452-454
REC18137-88L01	18137-88L01	452-454
REC18137-93J00	18137-93J00	452-454
REC18590-58M00	18590-58M00	452-454
REC18590-68H00	18590-68H00	452-454
REC18590-72F21	18590-72F21	452-454
REC22-8M0001721		443
REC23211-94401	23211-94401	523
REC23311-95DLO	23311-95DLO	520
REC24942		445
REC24950		445
REC24952		445
REC25000		445
REC25010		445
REC25020		445
REC25030		445
REC25222-93901	25222-93901	520
REC25222-96300	25222-96300	520
REC25700-87D00	25700-87D00	519
REC25700-87D00	25700-87D00	520
REC25700-87E00	25700-87E00	519
REC25700-87E00	25700-87E00	520
REC25700-87L00	25700-87L00	513-519-520
REC25700-88L00	25700-88L00	519
REC25700-88L00	25700-88L00	511
REC25700-88L00	25700-94400	519
REC25700-88L00	25700-88L00	509-520
REC25700-90J01	25700-90J01	515-520
REC25700-92J00	25700-92J00	515-516-519-520
REC25700-93J00	25700-93J00	517-519-520
REC25700-93L00	25700-93L00	518-519-520
REC25700-94500	25700-94500	520
REC25700-94700	25700-94700	519-520
REC25700-95501	25700-95500	519-520
REC25700-95D01	25700-95D00	519
REC25700-95D01	25700-95D01	507-519-520
REC25700-95J00	25700-95J00	505-519-520
REC25700-98J00	25700-98J00	519-520
REC25700-99E00	25700-99E00	512-519-520
REC25W40U3		450
REC2TU3		450
REC2TU6		450
REC32140-93900	32140-93900	455
REC32140-94400		

REF	R.O. / OEM		REF	R.O. / OEM		REF	R.O. / OEM	
REC32900-94480	32900-94480	455	REC51211-90J10	51211-90J10	484	REC57631-95303	57631-95302	523
REC32900-96340	32900-96340	455	REC51211-90J2	51211-90J21	484	REC57631-95303	57631-95303	509-511-523
REC32900-96371	32900-96370	460	REC51211-90J2	51211-90J22	484	REC57631-96301	57631-96301	507-523
REC32900-96371	32900-96370	460	REC51211-93J00	51211-93J00	484	REC57632-94J00	57632-93902	501
REC32900-96371	32900-96371	460	REC52113-93910	52113-93901	495	REC57632-94J00	57632-94J00	499-503-532
REC33220-58J20	33220-58J20	454	REC52113-96330	52113-96304	495	REC57632-97L00	57632-97L00	503-522
REC33220-76G02	33220-76G00	454	REC52331-87L00	52331-87L00	482-494	REC57632-97L00	57632-98500	522
REC33220-76G02	33220-76G01	454	REC55122-94400	55122-88L00	473-511	REC57632-97L00	57632-98501	497-522
REC33220-76G02	33220-76G02	454	REC55128-93J10	55128-93J00	521	REC57633-93901	57633-93900	532
REC33410-94400-000	33410-93E10	455	REC55128-93J10	55128-93J10	517-521	REC57633-93901	57633-93901	499-501-503-532
REC33410-94400-000	33410-94400-000	455	REC56120-93900	56120-90L00-OEP	521	REC57634-88L00	57634-88L00	509-511-522
REC34801-93J03	34801-93J00	463	REC56120-93900	56120-90L01-OEP	521	REC59178-97J00	59178-97J00	439-440-499-503-521
REC34801-93J03	34801-93J01	463	REC56120-93900	56120-90L02-OEP	521	REC5W40U3		450
REC34801-93J03	34801-93J02	463	REC56120-93900	56120-93900-002M	521	REC5W40U6		450
REC34801-93J03	34801-93J03	463	REC56120-93900	56120-93900-OEP	521	REC63610-89E01	63610-89E01-000	467
REC34801-94710	34801-94700	463	REC56120-93900	56120-93901-OED	521	REC63610-91J20	63610-91J00	467
REC34801-94710	34801-94710	463	REC56120-93900	56120-93901-OEP	501	REC63610-91J20	63610-91J01	467
REC34801-99E04	34801-99E01	463	REC56120-93900	56120-93901-OEP	531	REC63610-91J20	63610-91J03	467
REC34801-99E04	34801-99E02	463	REC56120-94321-OEP	56120-94321-OEP	509-511-521	REC63610-91J20	63610-91J04	467
REC34801-99E04	34801-99E03	463	REC56120-96332-OEP	56120-96332-OEP	505-507-521	REC63610-91J20	63610-91J04	467
REC34801-99E04	34801-99E03	463	REC56130-94413-OEP	56130-94411-OEP	472	REC63610-91J20	63610-91J20	467
REC35-802893Q		445	REC56130-94413-OEP	56130-94413-OEP	472	REC63610-93501	63610-93501-000	467
REC35-802893Q01		445	REC56130-96331-OEP	56130-96332-OEP	472	REC63610-94402	63610-94402-000	467
REC36120-ZW4-H12	38100-88L00	462	REC56130-96331-OEP	56130-96331-OEP	472	REC63610-96302	63610-96302-000	467
REC36120-ZW4-H12	38100-88L11	462	REC57100-93902	57100-93902	501	REC63610-96321-000	63610-96321-000	467
REC36120-ZW4-H12	38100-88L12	462	REC57100-93902	57100-93902	531	REC63P-13907-03	15200-90J00	450
REC36120-ZY6-013	38100-90J30	462	REC57110-93912	57110-93912	531	REC63P-13907-03	15200-92J00	450
REC36120-ZY6-013	38100-90J40	462	REC57110-94411	57110-92L10	531	REC63P-13907-03	15200-93J01	450
REC36120-ZY6-013	38100-93J11	462	REC57110-94441	57110-94441	531	REC63P-14984-00	15200-92J00	450
REC36120-ZY6-013	38100-93J13	462	REC57311-93901	57311-93901	525	REC650-24351-51		443
REC36120-ZY9-003	38100-87L00	462	REC57311-93901	57311-93901	531	REC65720-98520	65720-98500	443
REC36120-ZY9-003	38100-87L01	462	REC57311-93910	57311-90L00	525	REC65720-98520	65720-98501	443
REC36120-ZY9-003	38100-87L02	462	REC57311-93910	57311-93910	501-525	REC65720-98520	65720-98502	443
REC36120-ZY9-003	38100-87L03	462	REC57311-93910	57311-93910	531	REC65720-98520	65720-98520	443
REC36620-93J02	36620-93J02	466	REC57311-94402	57311-94401	525	REC65720-98520	65720-98521	443
REC36620-94J01	36620-94J01	466	REC57311-94402	57311-94402	525	REC65720-98520	65720-98511	443
REC37100-96J15	37100-96J14	465	REC57311-94402	57311-94402	531	REC65720-986L0	65720-986A0	443
REC37100-96J15	37100-96J15	465	REC57311-96311	57311-91L00	525	REC65720-986L0	65720-986B0	443
REC37100-96J25	37100-96J20	465	REC57311-96311	57311-96310	525	REC65720-986L0	65720-986L0	443
REC37100-96J25	37100-96J21	465	REC57311-96311	57311-96311	525	REC65750-94404	65750-94401	443
REC37100-96J25	37100-96J22	465	REC57311-96311	57311-96320	525	REC65750-94404	65750-94402	443
REC37100-96J25	37100-96J23	465	REC57311-96311	57311-91L00	531	REC65750-94404	65750-94404	443
REC37100-96J25	37100-96J24	465	REC57311-96320	57311-96320	505-507-531	REC65L-24563-00	15412-93J00	447
REC37100-96J25	37100-96J25	465	REC57311-98400	57311-98400	531	REC67200-88L00	67200-88L00	465
REC37110-99E00	37110-99E00	458	REC57311-98600	57311-91J00	497	REC67200-88L00	67200-93J12	465
REC37800-93954	37800-93953	460	REC57311-98600	57311-98600	525	REC67200-88L00	67200-93J13	465
REC37800-93954	37800-93954	460	REC57311-98601	57311-98601	525	REC67200-88L10	67200-88L10	465
REC37820-92E03	37820-92E00	460	REC57311-99J10	57311-97J10	503	REC67200-88L10	67200-93J15	465
REC37830-89E03	37830-89E02	460	REC57311-99J10	57311-99J10	499-525	REC67200-93J51	67200-93J00	464
REC37830-89E03	37830-95000	460	REC57510-89J00	57510-89J00	505-507-525	REC67200-93J51	67200-93J01	464
REC38100-87E10-OED	38100-87D00	461	REC57510-89J00	57510-91L00	525-531	REC67200-93J51	67200-93J02	464
REC38100-87E10-OED	38100-87D01-02M	461	REC57510-91J00	57510-91J00	497-525	REC67200-93J51	67200-93J03	464
REC38100-87E10-OED	38100-87D01-OED	461	REC57510-91J00	57510-98600	525	REC67200-93J51	67200-93J04	464
REC38100-87E10-OED	38100-87D02H	461	REC57510-91J00	57510-98610	525	REC67200-93J51	67200-93J06	464
REC38100-87E10-OED	38100-87D01H	461	REC57510-91J00	57510-98611	525	REC67200-93J51	67200-93J06	464
REC38100-87E10-OED	38100-87E10-OED	461	REC57510-93902	57510-93902	525	REC67200-93J51	67200-93J50	464
REC38100-87J00	37100-87J00-OEP	462	REC57510-93902	57510-93902	531	REC67200-94J20	67200-91J00	464
REC38100-87J00	38100-87J0EP	462	REC57510-93910	57510-90L00	525	REC67200-94J20	67200-91J01	464
REC38100-96J00	38100-92J01	461	REC57510-93910	57510-93910	501-525	REC67200-94J20	67200-91J04	464
REC38100-96J00	38100-92J02	461	REC57510-93910	57510-93910	531-532	REC67200-94J20	67200-94J20	464
REC38100-96J00	38100-92J10	461	REC57510-94402	57510-94400	525	REC67200-94J20	67200-99E10-OEP	464
REC38100-96J00	38100-92J12	461	REC57510-94402	57510-94401	525	REC67200-99E56	67200-99E30-OEP	464
REC38100-96J00	38100-93J02	461	REC57510-94402	57510-94402	525	REC67200-99E56	67200-99E50	464
REC38100-96J00	38100-96J00	461	REC57510-94402	57510-94402	531	REC67200-99E56	67200-99E51	464
REC38100-96J00	38100-96J01	461	REC57510-99J11	57510-99J10	503	REC67200-99E56	67200-99E56	464
REC38100-97E00-OED	38100-97E00-OED	462	REC57521-89J00	57521-89J00	505-507-526-531	REC67200-99E56	67200-99E56	464
REC38100-99E01-OEP	38100-99E01-00	462	REC57521-91J00	57521-91J00	497-526	REC67F-12411-01	17670-93J00	468
REC38100-99E01-OEP	38100-99E01-OED	462	REC57521-93902	57310-93850	526	REC692-24410-00	15100-94301	450
REC38100-99E01-OEP	38100-99E01-OED	462	REC57521-93902	57521-93902	526	REC692-24410-00	15100-94303	450
REC38860-76F01	38860-76F01	460	REC57521-93910	57521-90L00	526	REC692-24410-00	15100-94310	450
REC40135		447	REC57521-93910	57521-93910	501-526-531	REC69J-24501-10	15643-93J00	448
REC40145		447	REC57521-94400	57310-94401	526	REC6E5-24351-51		443
REC40155		447	REC57521-94400	57521-94400	526	REC70720		447
REC40165		447	REC57521-94400	57521-94400	531	REC80W90U3	990A0-01E81-01Q	450
REC40970		461	REC57521-96312	57521-96311	526	REC80W90U6	990A0-01E81-05Q	450
REC40990		461	REC57521-96312	57521-96312	526	REC855686		445
REC43211-87JL0	43211-87JL0	466	REC57521-96312	57521-96312	531	REC89-825096T01	31800-94400	458
REC43211-87JL0	43211-94401	466	REC57521-96312	57521-99J10	503	REC89-825096T01	31800-94401	458
REC43211-94401	43211-94401	466	REC57521-99J10	57521-99J10	501-531	REC89-825096T01	38410-89J00	458
REC43711-97E11	43711-97E00	466	REC57610-93901	57610-93901	509-511	REC89-825096T01	38410-94550	458
REC43711-97E11	43711-97E11	466	REC57610-94402	57610-94402	505-507	REC89-825096T01	38410-94551	458
REC48503-93J12	48503-93J10	462	REC57610-96311	57610-96311	505-507	REC89-825096T01	38410-94552	458
REC48503-93J12	48503-93J12	462	REC57621-91L10	57621-91L10	522	REC90171-18M04	09141-18005	509-511-512-513-515-516-517-532
REC48503-93J12	48503-94900-OED	462	REC57621-91L10	57621-96300	522	REC90171-18M04	90171-18M04	518
REC48630-92J00	48630-92J00	463	REC57621-91L10	57621-96310	522	REC90179-08M06	09159-08046	505-507
REC48630-93J00	48630-93J00	463	REC57621-94403	57621-87J01	522	REC90794-46866	65900-98J00	446
REC48630-94900	48630-94900	463	REC57621-94403	57621-87J02	522	REC90794-46868	15410-98500	448
REC48630-96J00	48630-96J00	463	REC57621-94403	57621-87J03	522	REC90794-46868	65910-98J00	446
REC48630-96J03	48630-96J01	463	REC57621-94403	57621-87J03	509-511-522	REC925093	09280-75002	507
REC48630-96J03	48630-96J02	463	REC57621-94403	57621-94400	522	REC93101-22067	09282-22004	490
REC48630-96J03	48630-96J03	463	REC57621-94403	57621-94403	522	REC93101-22067	09282-22007	490
REC48630-98L01	48630-98L00	463	REC57621-94403	57621-94403	522	REC93606-12019	09202-06031	515-516-517-518
REC48630-98L01	48630-98L01	463	REC57621-94403	57621-94403	522-531	RECOBRACKET		445
REC51123-87L00	51123-87L00	482-486	REC57630-92E00	57630-92E00	517-518-531			
REC51123-93J00	51123-93J00	485	REC57630-94300	57630-94300	511-531			

REF	R.O. / OEM	
RECOBELEMENT		445
RECOFILALU		445
RECOFILTER		445
RECPIN4		463
RECPIN4.5		463
RECPIN6		463
RECTOOLTRIM1		463
RECTOOLTRIM2		463
RECTOOLTRIM3		463
RECTOOLTRIMKIT		463
RECYS-225-15		446
RM35-802893Q		445
RM92-858026QB1U6		450
RM92-858027QB1U3		450
RM92-8M0086220U6		450
RM92-8M0086221U3		450

<b>S</b>		
REF	R.O. / OEM	
SIE18-8013		442
SIE18-8015		442
SOL2431-130-19	58100-95530-019	528
SOL2431-133-17	58100-95521-019	528
SOL2431-135-15	58100-95511-019	528
SOL3411-139-17	58100-90J00-019	528
SOL3411-139-19	58100-90J10-019	528
SOL3411-139-21	58100-90J20-019	528
SOL3413-138-15	58100-90J40-019	528
SOL3413-138-17	58100-90J00-019	528
SOL3413-138-19	58100-90J10-019	528
SOL3413-138-21	58100-90J20-019	528
SOL3451-139-17	58100-90J00-019	528
SOL3451-139-17	99105-00700-18P	528
SOL3451-139-19	58100-90J10-019	528
SOL3451-139-19	99105-00700-20P	528
SOL3451-139-21	58100-90J20-019	528
SOL3451-139-21	99105-00700-22P	528
SOL3451-139-23	58100-90J22-019	528
SOL3451-139-23	99105-00700-24P	528
SOL3452-139-17	99105-0070L-18P	528
SOL3452-139-19	99105-0070L-20P	528
SOL3452-139-21	99105-0070L-22P	528
SOL4011-079-07S	58110-91JN0-019	497-528
SOL4111-093-07A	58100-89L00-019	528
SOL4111-093-08A	58100-90L41-019	528
SOL4111-093-09A	58100-89L20-019	528
SOL4111-093-10A	58100-89L60-019	528
SOL4111-093-11A	58100-89L70-019	528
SOL4111-093-12A	58100-89L50-019	528
SOL4211-100-14	58100-95D00-019	528
SOL4211-100-15	58100-96460-019	528
SOL4211-101-13	58100-96440-019	528
SOL4211-103-12	58100-96430-019	528
SOL4211-105-11	58100-96420-019	528
SOL4211-110-09	58100-96410-019	528
SOL4311-110-15	58100-95363-019	528
SOL4311-116-12	58100-95393-019	528
SOL4311-116-13	58100-94313-019	528
SOL4311-116-14	58100-95353-019	528
SOL4311-118-11	58100-95222-019	528
SOL4311-120-10	58100-95212-019	528
SOL4311-121-09	58100-94302-019	528
SOL4411-130-19	58100-94522-019	528
SOL4411-130-21	58100-94532-019	528
SOL4411-133-17	58100-94512-019	528
SOL4411-135-15	58100-94500-019	528
SOL4411-138-13		528
SOL4411-140-11		528
SOL4413-125-19	58100-94522-019	528
SOL4413-125-21	58100-94532-019	528
SOL4413-128-17	58100-94512-019	528
SOL4413-130-15	58100-94500-019	528
SOL4413-133-13		528
SOL4431-130-19	58100-94522-019	528
SOL4431-130-19	58100-94561-019	528
SOL4431-130-19	99105-00100-20P	528
SOL4431-130-21	58100-94532-019	528
SOL4431-130-21	58100-94571-019	528
SOL4431-130-21	99105-00100-22P	528
SOL4431-133-17	58100-94512-019	528
SOL4431-133-17	58100-94581-019	528
SOL4431-133-17	99105-00100-18P	528
SOL4431-135-15	58100-94500-019	528
SOL4431-135-15	58100-94554-019	528
SOL4431-135-15	99105-00100-16P	528
SOL4511-142-23	99105-00200-24P	529
SOL4511-143-21	99105-00200-22P	529
SOL4511-145-19	99105-00200-20P	529
SOL4511-148-17	99105-00200-18P	529
SOL4511-150-15	99105-00200-16P	529
SOL4511-150-15	58200-87D61-019	529
SOL4511-153-19	99105-00200-20P	529
SOL4511-153-21	99105-00200-22P	529
SOL4511-155-17	99105-00200-18P	529
SOL4512-142-23	99105-0020L-24P	529
SOL4512-143-21	99105-0020L-22P	529
SOL4512-145-19	99105-0020L-20P	529
SOL4512-148-17	99105-0020L-18P	529
SOL4512-150-15	99105-0020L-16P	529
SOL4512-153-19		529
SOL4512-153-21		529
SOL4512-155-17		529
SOL4512-158-15		529
SOL4513-140-21	58200-87D21-019	529
SOL4513-143-19	58200-87D11-019	529

REF	R.O. / OEM	
SOL4513-145-17	58200-87D01-019	529
SOL4513-148-15	58200-87D61-019	529
SOL4551-140-24	99105-00200-24P	529
SOL4551-143-22	58200-87D21-019	529
SOL4551-143-22	99105-00200-22P	529
SOL4551-148-16	58200-87D61-019	529
SOL4551-148-16	99105-00200-16P	529
SOL4551-148-18	58200-87D01-019	529
SOL4551-148-18	99105-00200-18P	529
SOL4551-148-20	58200-87D11-019	529
SOL4551-148-20	99105-00200-20P	529
SOL4552-140-24	99105-0020L-24P	529
SOL4552-143-22	58200-87D22-019	529
SOL4552-143-22	99105-0020L-22P	529
SOL4552-148-16	58200-87D62-019	529
SOL4552-148-16	99105-0020L-16P	529
SOL4552-148-18	58200-87D02-019	529
SOL4552-148-18	99105-0020L-18P	529
SOL4552-148-20	58200-87D12-019	529
SOL4552-148-20	99105-0020L-20P	529

<b>T</b>		
REF	R.O. / OEM	
SOL4571-148-23		529
SOL4571-149-22		529
SOL4571-151-20		529
SOL4571-154-18		529
SOL4572-148-23		529
SOL4572-149-22		529
SOL4572-151-20		529
SOL4572-154-18		529
SOL9311-110-15		530
SOL9311-111-13		530
SOL9311-111-14		530
SOL9311-114-12		530
SOL9311-116-11		530
SOL9311-120-10		530
SOL9311-121-09		530
SOL9331-110-15		530
SOL9331-111-13		530
SOL9331-111-14		530
SOL9331-114-12		530
SOL9331-114-12		530
SOL9331-116-11		530
SOL9411-132-19		530
SOL9411-132-21		530
SOL9411-133-17		530
SOL9411-135-15		530
SOL9411-138-13		530
SOL9411-140-09		530
SOL9411-140-11		530
SOL9431-130-19		530
SOL9431-130-21		530
SOL9431-133-17		530
SOL9431-135-15		530
SOL9431-138-13		530
SOL9432-130-19		530
SOL9432-133-17		530
SOL9432-135-15		530
SOL9432-138-13		530
SOL9511-143-21		530
SOL9511-145-19		530
SOL9511-148-17		530
SOL9511-150-15		530
SOL9511-153-13		530
SOL9511-155-11		530
SOL9511-160-13		530
SOL9531-140-19		530
SOL9531-140-21		530
SOL9531-140-23		530
SOL9531-143-17		530
SOL9531-145-15		530
SOL9532-140-19		530
SOL9532-140-21		530
SOL9532-140-23		530
SOL9532-143-17		530
SOL9532-145-15		530
SOL9571-145-25		530
SOL9571-148-23		530
SOL9571-150-21		530
SOL9571-153-19		530
SOL9571-155-17		530
SOL9571-158-15		530
SOL9572-145-25		530
SOL9572-148-23		530
SOL9572-150-21		530
SOL9572-153-19		530
SOL9572-155-17		530
SOL9572-158-15		530
SOLRBX-104		529
SOLRBX-110		529
SOLRBX-115		529
SOLRBX-125		529
SOLRBX-126		529
SOLRBX-150		529

REF	R.O. / OEM	
TEN01166	11281-94400	479
TEN01200	55125-96310	478
TEN01201	55125-95301	478
TEN01202	55320-98600	478
TEN01203	41810-87D00	479
TEN01204	55320-95310	478
TEN01204	55320-98311	478
TEN01204AL	55320-95310	478
TEN01204AL	55320-98311	478
TEN01205	11130-94600	479
TEN01206	55321-93900	478

REF	R.O. / OEM	
TEN01207	55320-98600	478
TEN01207	55321-95500	478
TEN01208	55300-95500	478
TEN01209	55125-94502	479
TEN01209	55321-94502	479
TEN01210	55320-98400	478
TEN01210/1	41811-98500	478
TEN01211	55120-87801	478
TEN01211	55125-87D00	478
TEN01212	55321-90J01	478
TEN01213	55321-87J00	478
TEN01213	55321-87J01	478
TEN01213	55321-87J00	479
TEN01214	55320-94900	478
TEN01214AL	55320-94900	478

TEN01215	55125-90J01	478-512-513-515-516
TEN01215	55125-98J00	517
TRI305-0386		442
TRI305-0566		442
TX4200K		467
TX6400K		467

SUZUKI

RECAMBIOS MARINOS



R.O. / OEM	REF		R.O. / OEM	REF		R.O. / OEM	REF	
13650-52G00	REC13650-52G00	454	16510-90J00	REC16510-90J00	440-441-449	17411-93901	REC17411-93901	471-501
13650-56B00	REC13650-56B00	454	16510-92J00	REC16510-82703	449	17411-94421	REC17411-94421	471-507-509
13910-87D00	REC13910-87D00	453	16510-96J00	REC16510-93J00	449	17413-92J00	REC17413-92J01	473
13910-89J01	REC13910-89J01	453	16510-96J00	REC16510-96J00	449	17413-92J01	REC17413-92J01	473-515-516
13910-94400	REC13910-94400	453	16510-96J10	REC16510-93J00	449	17413-95J00	REC17413-95J00	439-473-505-511
13910-94701	REC13910-94701	453	16510-96J10	REC16510-96J00	441	17413-96J00	REC17413-96J01	473
14141-93952-0EP	REC14141-93952-0EP	495	16510-96J10	REC16510-96J00	449	17413-96J01	REC17413-96J01	441-473-517
14151-87L00	REC14151-87L00	494	16539-87L00	REC16539-87L00	482-485	17413-99E10	REC17413-99E11	512-513
14151-93901	REC14151-93912	495	17400-87811	REC17400-87810	440	17413-99E11	REC17413-99E11	473
14151-93J00	REC14151-93J00	494	17400-87820	REC17400-87820	440	17416-92J00	REC17416-92J00	515
14151-94412	REC14151-94411	495	17400-87D00	REC17400-87D11	474	17416-92J10	REC17416-92J10	472-515-516
14151-96310	REC14151-96311	495	17400-87D10	REC17400-87D11	474	17416-93J00	REC17416-93J00	472-518
14152-93J00	REC14152-93J00	494	17400-87D11	REC17400-87D11	474-476	17416-95J00	REC17416-95J00	472-505-511
14212-91L00	REC14212-91L00	495	17400-87E03	REC17400-87E04	440-474-476	17416-96J00	REC17416-96J00	472-517
14212-93J00	REC14212-93J00	494			512	17416-99E10	REC17416-99E10	472-513
14212-94412	REC14212-94413	495	17400-87L00	REC17400-87L01	475	17417-92J00	REC17417-92J00	472-515
14212-96310	REC14212-91L00	495	17400-87L01	REC17400-87L01	440-475-476	17431-92L20	REC17431-92L20	521
15100-91J00	PAF4-04090000	450	17400-88810	REC17400-88810	440	17431-94440	REC17431-92L20	521
15100-91J01	PAF4-04090000	450	17400-88810	REC17400-88810	440-475-476	17431-94441	REC17431-92L20	521
15100-91J02	PAF4-04090000	450	17400-88L00	REC17400-88L00	511	17450-93440	REC17450-93921	471
15100-94301	REC692-24410-00	450	17400-89810	REC17400-89810	439	17450-93920	REC17450-93921	471
15100-94303	REC692-24410-00	450	17400-89820	REC17400-89820	440	17450-93921	REC17450-93921	471-501
15100-94310	REC692-24410-00	450	17400-90J11	REC17400-90J20	475	17450-93930	REC17450-93921	471
15100-94311	REC692-24410-00	450	17400-90J20	REC17400-90J20	476-515	17451-96301	CEF500362G	469
15170-91J00	REC15170-91J00	451	17400-91830	REC17400-91830	439	17451-96301	REC17461-96312	469
15170-93920	REC15170-93911	451	17400-91860	REC17400-91860	439	17452-93910	REC17452-93910	473-501
15170-94320	REC15170-94320	451	17400-92821	REC17400-92821	441	17453-93900	REC17453-93901	501-521
15170-94J00	REC15170-94J00	451	17400-92840	REC17400-92840	440	17453-93901	REC17453-93901	521
15170-98110	REC15170-98110	451	17400-92850	REC17400-92850	441	17461-87E10	CEF500365	470
15170-99E00	REC15170-99E00	451	17400-92D01	REC17400-92D01	474-476	17461-87E10	REC17461-87E12	470
15200-90J00	REC63P-13907-03	450	17400-92D11	REC17400-92D01	474	17461-87E11	CEF500365	470
15200-92J00	REC63P-13907-03	450	17400-92J20	REC17400-92J00	475-476	17461-87E11	REC17461-87E12	470
15200-92J00	REC63P-14984-00	450			440-441-	17461-87E12	CEF500365	469-470
15200-93J01	REC63P-13907-03	450	17400-92J21	REC17400-92J21	475-476-515	17461-87E12	REC17461-87E12	469-470-512-513
15200-96J00	REC15200-96J00	450			516	17461-87E12	REC17461-87E12	469
15410-87J10	REC15410-87J00	448	17400-93851	REC17400-93851	441	17461-90J00	CEF500367	469
15410-87J10	REC15410-87J10	440-447	17400-93911	REC17400-93912	475	17461-90J00	REC17461-90J01	469
15410-87J30	REC15410-87J30	439-440-441-447	17400-93912	REC17400-93912	475	17461-90J01	CEF500367	469-470
15410-87L00	REC15410-87L00	439-440-447	17400-93950	REC17400-93951	474-501	17461-90J01	REC17461-90J01	469-470-515-516-517
15410-88L00	REC15410-88L00	440-448	17400-93951	REC17400-93951	476-501	17461-92D02	CEF500319	469
15410-93J00	REC15410-93J00	448	17400-93J00	REC17400-93J01	474	17461-92D02	REC17461-92D02	469
15410-94350	REC16910-GB2-005	448	17400-93J01	REC17400-93J01	441-474-476	17461-93001	CEF500398	469
15410-94400	PAF15-07080000	447	17400-93J02	REC17400-93J01	474	17461-93002	CEF500398	469
15410-96J00	REC15410-96J00	441-447	17400-93J02	REC17400-93J01	474	17461-93002	REC17461-93004	469
15410-98500	REC15410-98500	439-448	17400-94611	REC17400-94611	475-476	17461-93002	CEF500398	469
15410-98500	REC90794-46868	448	17400-94700	REC17400-94701	474	17461-93002	REC17461-93004	469
15412-92J00	REC15412-92J00	441-448	17400-94701	REC17400-94701	474-476	17461-93003	CEF500398	469
15412-93J00	REC65L-24563-00	447	17400-94810	REC17400-94810	439	17461-93003	REC17461-93004	469
15412-93J10	REC15412-93J10	441-448	17400-94821	REC17400-94821	440	17461-93004	CEF500398	469
15440-87L10	REC15440-87L10	448	17400-94J20	REC17400-94J00	439-476	17461-93004	REC17461-93004	469
15440-90J00	REC15440-90J00	448	17400-94L00	REC17400-94L00	440-475-476	17461-93901	CEF500329	469
15440-93J00	REC15440-93J00	448	17400-95350	REC17400-95351	474	17461-93901	REC17461-93903	469
15440-96J00	REC15440-96J00	448	17400-95351	REC17400-95351	474-476	17461-93902	CEF500329	469
15440-96J01	REC15440-96J01	448	17400-95550	REC17400-95351	474	17461-93902	REC17461-93903	469
15440-99E00	REC15440-99E01	449	17400-95870	REC17400-95870	439	17461-93903	CEF500329	469-470
15440-99E01	REC15440-99E01	449	17400-95J01	REC17400-95J02	476	17461-93903	REC17461-93903	470
15626-90J00	REC15626-90J00	451	17400-95J02	REC17400-95J02	439-476-505	17461-93903	REC17461-93903	469-470-501-503
15626-99E00	REC15626-99E00	451	17400-96350	REC17400-96403	474	17461-939M0	REC17461-93903	499
15643-93J00	REC69J-24501-10	448	17400-96351	REC17400-96403	474	17461-93J00	CEF500393	470
15643-99E00	REC15626-99E00	451	17400-96352	REC17400-96403	474-507	17461-93J00	REC17461-93J00	470-518
15710-50M00	REC15710-89L00	451	17400-96353	REC17400-96403	509	17461-94510	CEF500367	469
15710-65D00	REC15710-65D00	451-452	17400-96403	REC17400-96403	440-474-476-509	17461-94510	REC17461-90J01	469
15710-82K50	REC15710-82K50	452	17400-96821	REC17400-96821	441	17461-94700	CEF500361	469
15710-82M00	REC15710-82M00	452	17400-96J00	REC17400-96J03	475	17461-94700	REC17461-94700	469
15710-85K00	REC15710-85K00	452	17400-96J01	REC17400-96J03	475	17461-94701	CEF500361	469
15710-87J00	REC15710-87J00	452	17400-96J02	REC17400-96J03	475	17461-94701	REC17461-94700	469
15710-87L00	REC15710-87L00	451-452	17400-96J03	REC17400-96J03	441-475-476-517	17461-94701	REC17461-96312	470
15710-89L00	REC15710-89L00	451-452	17400-97810	REC17400-97810	439	17461-94L00	REC17461-96312	470
15710-93J00	REC15710-93J00	452	17400-97821	REC17400-97820	439	17461-95200	CEF500361	469
15710-96J00	REC15710-96J00	452	17400-98551	REC17400-98551	474-476	17461-95200	REC17461-94700	469
15710-99E00	REC15710-99E00	452	17400-98652	REC17400-98652	474-476	17461-95201	REC17461-94700	469
16433-93J00	REC16433-93J00	485	17400-98661	REC17400-98652	474	17461-95300	CEF500360	469
16510-05240	REC16510-05240	449	17400-98661	REC17400-98661	439-474-476-497	17461-95300	REC17461-95300	469
16510-05240	REC16510-05240	439-449	17400-98661	REC17400-98661	497	17461-95301	CEF500360	469
16510-45H10	REC16510-05240	449	17400-986L0	REC17400-98661	474	17461-95301	REC17461-95300	469
16510-61A01	REC16510-90J00	449	17400-986L1	REC17400-98661	474	17461-95302	CEF500360	469
16510-61A20-MHL	REC16510-90J00	449	17400-98861	REC17400-98861	441	17461-95303	REC17461-95300	469
16510-61A21-MHL	REC16510-90J00	449	17400-98861	REC17400-98861	441	17461-95501	CEF500360	469
16510-61A30	REC16510-90J00	449	17400-98J00	REC17400-98J01	474	17461-95501	REC17461-95300	469
16510-61A31	REC16510-90J00	449	17400-98J01	REC17400-98J01	474-518	17461-96301	CEF500362G	469
16510-81420	REC16510-82703	449	17400-98J02	REC17400-98J01	441-474-476	17461-96301	REC17461-96312	469
16510-82703	REC16510-82703	449	17400-99840	REC17400-99840	439	17461-96310	CEF500362G	469
16510-87J00	REC16510-87J00	449	17400-99870	REC17400-99870	440	17461-96310	REC17461-96312	469
16510-87J00	REC16510-87J00	449	17400-99J00	REC17400-99J01	475	17461-96310	CEF500362G	469
16510-87J00	REC16510-87J00	439-440-449	17400-99J01	REC17400-99J01	439-475-476-499-503	17461-96312	REC17461-96312	470
16510-87JL0	REC16510-87J00	449	17410-93910	REC17411-93901	471	17461-96312	REC17461-96312	470-505-507-509-511
16510-90J00	REC16510-90J00	449	17410-94431	REC17411-94421	471			

R.O. / OEM	REF		R.O. / OEM	REF		R.O. / OEM	REF	
17461-96400	CEF500399	469	25700-95500	REC25700-95501	519-520	32800-99J00	REC32800-99J00	459
17461-97110	REC17461-97JMO	439-470	25700-95D00	REC25700-95D01	519	32900-93902	REC32900-93903	455
17461-98501	CEF500336	469	25700-95D01	REC25700-95D01	507-519-520	32900-93903	REC32900-93903	455
17461-98501	REC17461-98503	469	25700-95J00	REC25700-95J00	505-519-520	32900-93911	REC32900-93911	460
17461-98502	CEF500336	469	25700-98J00	REC25700-98J00	519-520	32900-94401	REC32900-94480	455
17461-98502	REC17461-98503	469	25700-99E00	REC25700-99E00	512-519-520	32900-94421	REC32900-94480	455
17461-98503	CEF500336	469-470	29116-93J00	PAGB/T5787-M6X20	501	32900-94460	REC32900-94460	460
17461-98503	REC17461-98503	469-470	29116-93J10	PAF8-00000003	513	32900-94470	REC32900-94460	460
17461-985M0	REC17461-98503	470-497	29141-93J00	PAGB/T6170-M6	497-499-501-505-509-511	32900-94480	REC32900-94480	455
17462-93990	REC17462-93990	470-501	29141-93J00	PAGB/T6184-2000	503	32900-96340	REC32900-96340	455
17471-87E00	REC17471-92J00	471	29162-93J00	PAGB/T93-6	499-501-509-511	32900-96350	REC32900-96371	460
17471-87E01	REC17471-92J00	471-512	31100-87000	PH130-0052	457	32900-96370	REC32900-96371	460
17471-92J00	REC17471-92J00	471-515-516	31100-87500	PH130-0079	458	32900-96371	REC32900-96371	460
17471-93902	REC17471-93902	471-501	31100-87D00	PH130-0052	457	33220-58J20	REC33220-58J20	454
17471-93J00	REC17471-92J02	471	31100-87D10	PH130-0052	457	33220-76G00	REC33220-76G02	454
17471-93J01	REC17471-92J02	471	31100-87J00	PH130-0079	458	33220-76G01	REC33220-76G02	454
17471-93J02	REC17471-92J02	471-517	31100-87J10	PH130-0079	458	33220-76G02	REC33220-76G02	454
17471-94401	REC17471-94401	471-507-509	31100-87J11	PH130-0079	458	33410-93E10	REC33410-94400-000	455
17471-95J00	REC17471-95J01	471	31100-89J00	PH130-0006	457	33410-94400-000	REC33410-94400-000	455
17471-95J01	REC17471-95J01	471-505-511	31100-90J00	PH130-0071	457	34801-93J00	REC34801-93J03	463
17471-97J00-00	REC17471-97J00	439-471	31100-90J01	PH130-0071	457	34801-93J01	REC34801-93J03	463
17471-97JL0	REC17471-97JL0	439-471	31100-92E00	PH130-0052	457	34801-93J02	REC34801-93J03	463
17471-98600	REC17471-98601	471	31100-93J00	PH130-0078	458	34801-93J03	REC34801-93J03	463
17471-98601	REC17471-98601	471	31100-94400	PH130-0006	457	34801-94700	REC34801-94710	463
17471-98610	REC17471-98610	471	31100-94402	PH130-0006	457	34801-94710	REC34801-94710	463
17472-87E00	REC17472-87E10	472	31100-94401	PH130-0006	457	34801-99E01	REC34801-99E04	463
17472-87E10	REC17472-87E10	472-512-515-516	31100-94500	PH130-0053	457	34801-99E02	REC34801-99E04	463
17472-87L00	REC17472-87L00	472-482-513	31100-94510	PH130-0053	457	34801-99E03	REC34801-99E04	463
17472-91J00	REC17472-91J00	473-497	31100-94511	PH130-0053	457	34801-99E04	REC34801-99E04	463
17472-92D10	REC17472-92D10	473	31100-94512	PH130-0053	457	36620-93J02	REC36620-93J02	466
17472-93911	REC17472-93911	473-501	31100-94600	PH130-0053	457	36620-94J01	REC36620-94J01	466
17472-93J00	REC17472-93J00	473-517	31100-94601	PH130-0053	457	37100-87J00-OEP	REC37100-87J00	462
17472-95310	REC17472-95310	473	31100-94610	PH130-0053	457	37100-96J14	REC37100-96J15	465
17472-96301	REC17472-96303	472	31100-94702	PH130-0075	457	37100-96J15	REC37100-96J15	465
17472-96302	REC17472-96303	472	31100-94J10	PH130-0077	457	37100-96J20	REC37100-96J25	465
17472-96303	REC17472-96303	472-481-505-507-509-511	31100-94J20	PH130-0077	457	37100-96J21	REC37100-96J25	465
17472-97J00	REC17472-97J00	439-472	31100-94J21	PH130-0077	457	37100-96J22	REC37100-96J25	465
17472-97JL0	REC17472-97JL0	439-472	31100-94J22	PH130-0077	457	37100-96J23	REC37100-96J25	465
17472-98503	REC17472-98503	473	31100-95240	PH130-0007	457	37100-96J24	REC37100-96J25	465
17472-98611	REC17472-98611	473	31100-95242	PH130-0007	457	37100-96J25	REC37100-96J25	465
17472-98J00	REC17472-98J00	472-518	31100-95243	PH130-0007	457	37110-99E00	REC37110-99E00	458
17560-91L00	REC17560-91L00	521	31100-95310	PH130-0060	457	37800-93953	REC37800-93954	460
17560-96300	REC17560-91L00	521	31100-95312	PH130-0060	457	37800-93954	REC37800-93954	460
17560-96301	REC17560-91L00	521	31100-95313	PH130-0060	457	37820-92E00	REC37820-92E03	460
17560-96304	REC17560-91L00	521	31100-95521	PH130-0060	457	37830-89E02	REC37830-89E03	460
17616-87J00	REC17616-87J00	468-481-486	31100-95600	PH130-0060	457	37830-95000	REC37830-89E03	460
17670-90J20	REC17670-90J20	468	31100-95601	PH130-0060	457	38100-87D00	REC38100-87E10-OED	461
17670-91J00	REC17670-91J01	468	31100-95D00	PH130-0006	457	38100-87D01-02M	REC38100-87E10-OED	461
17670-91J01	REC17670-91J01	468	31100-95J00	PH130-0077	457	38100-87D01-0ED	REC38100-87E10-OED	461
17670-93962	REC17670-93962	468	31100-95J01	PH130-0077	457	38100-87D02H	REC38100-87E10-OED	461
17670-93J00	REC67F-12411-01	468	31100-96310	PH130-0006	457	38100-87D0IT	REC38100-87E10-OED	461
17670-94402	REC17670-94402	468	31100-96311	PH130-0006	457	38100-87D10-0ED	PH200-T024	462
17670-94J00	REC17670-94J01	468	31100-96J00	PH130-0078	458	38100-87D10-0IT	PH200-T024	462
17670-94J01	REC17670-94J01	468	31100-96J01	PH130-0078	458	38100-87D10-35J	PH200-T024	462
17685-87D00	REC17685-87D10	486-488	31100-98L00	PH130-0078	458	38100-87E10-0ED	REC38100-87E10-OED	461
17685-87D10	REC17685-87D10	481-486-488	31100-98L10	PH130-0078	458	38100-87E20-0ED	PH200-T024	462
17693-95J00	REC17693-95J00	485	31800-94400	REC89-825096T01	458	38100-87J11	PH200-T046	462
1770-90J10	REC17670-90J10	468	31800-94401	REC89-825096T01	458	38100-87J20	PH200-T046	462
17822-90J00	REC09401-11425	443	32140-93900	REC32140-93900	455	38100-87J0EP	REC38100-87J00	462
17822-90J00	REC09401-11425BULK	443	32140-94400	REC32140-94400	455	38100-87L00	REC36120-ZY9-003	462
17913-93J00	REC17913-93J00	469	32140-96310	REC32140-96310	455	38100-87L01	REC36120-ZY9-003	462
17914-93J00	REC17914-93J00	469	32800-38F10	REC32800-38F10	458-459	38100-87L02	REC36120-ZY9-003	462
17914-93JL0	REC17914-93J00	469	32800-87J10	REC32800-87J10	459	38100-87L03	REC36120-ZY9-003	462
18137-52D00	REC18137-52D00	452-454	32800-87L00	REC32800-87L00	459	38100-88L00	REC36120-ZW4-H12	462
18137-87L01	REC18137-87L01	452-454	32800-88L00	REC32800-88L00	459	38100-88L11	REC36120-ZW4-H12	462
18137-88L01	REC18137-88L01	452-454	32800-89J00	REC32800-89J00	459	38100-88L12	REC36120-ZW4-H12	462
18137-93J00	REC18137-93J00	452-454	32800-89J10	REC32800-89J11	459	38100-90J30	REC36120-ZY6-013	462
18590-58M00	REC18590-58M00	452-454	32800-89J11	REC32800-89J11	459	38100-90J40	REC36120-ZY6-013	462
18590-68H00	REC18590-68H00	452-454	32800-89L00	REC32800-89L01	459	38100-92E00-OED	PH200-T024	462
18590-72F21	REC18590-72F21	452-454	32800-89L01	REC32800-89L01	459	38100-92J01	REC38100-96J00	461
23211-94401	REC23211-94401	523	32800-89L01	REC32800-89L01	459	38100-92J02	REC38100-96J00	461
23311-95DL0	REC23311-95DL0	520	32800-92E20	REC32800-92E20	459	38100-92J10	REC38100-96J00	461
25222-93901	REC25222-93901	520	32800-93J01	REC32800-93J03	459	38100-92J12	REC38100-96J00	461
25222-96300	REC25222-96300	520	32800-93J02	REC32800-93J03	459	38100-93J02	REC38100-96J00	461
25700-87D00	REC25700-87D00	519-520	32800-93J03	REC32800-93J03	459	38100-93J11	REC36120-ZY6-013	462
25700-87E00	REC25700-87E00	519-520	32800-93J03	REC32800-93J03	459	38100-93J13	REC36120-ZY6-013	462
25700-87L00	REC25700-87L00	513-519-520	32800-94J10	REC32800-94J11	459	38100-96J00	REC38100-96J00	461
25700-88400	REC25700-88L00	519	32800-94J11	REC32800-94J11	459	38100-96J01	REC38100-96J00	461
25700-88L00	REC25700-88L00	509-511-520	32800-94J11	REC32800-94J11	459	38100-97E00-OED	REC38100-97E00-OED	462
25700-90J01	REC25700-90J01	515-520	32800-95D01	REC32800-95D01	458	38100-99E01-00	REC38100-99E01-OEP	462
25700-92J00	REC25700-92J00	515-516-519-520	32800-95D01	REC32800-95D01	458	38100-99E01-0ED	REC38100-99E01-OEP	462
25700-93J00	REC25700-93J00	517-519-520	32800-95D01	REC32800-95D01	458	38100-99E01-0EP	REC38100-99E01-OEP	462
25700-93L00	REC25700-93L00	518-519-520	32800-98J01	REC32800-98J01	459	38410-89J00	REC89-825096T01	458
25700-94400	REC25700-88L00	519	32800-95720	REC32800-95720	458	38410-94550	REC89-825096T01	458
25700-94500	REC25700-94500	520	32800-95D00	REC32800-95D01	458	38410-94551	REC89-825096T01	458
25700-94700	REC25700-94700	519-520	32800-95D01	REC32800-95D01	458-459	38410-94552	REC89-825096T01	458
			32800-98J01	REC32800-98J01	459	38860-76F01	REC38860-76F01	460

R.O. / OEM	REF		R.O. / OEM	REF		R.O. / OEM	REF	
41810-87D00	TEN01203	479	55320-98600	TEN01207	478	57521-96311	REC57521-96312	526
41810-98500	CM5033167	439	55321-87J00	CM55321-87J00	476-497-501-511	57521-96312	REC57521-96312	526
41811-98500	CM41811-98500	476-501	55321-87J00	CM55321-87J00A	476	57521-96312	REC57521-96312	531
41811-98500	TEN01210/1	478	55321-87J00	TEN01213	478	57521-99J10	REC57521-99J10	503
43211-87JL0	REC43211-87JL0	466	55321-87J00	TEN01213	479	57610-93901	REC57610-93901	501-531
43211-94401	REC43211-87JL0	466	55321-87J01	CM55321-87J00	476-479-499-503	57610-94402	REC57610-94402	509-511
43211-94401	REC43211-94401	466	55321-87J01	CM55321-87J00A	476	57610-96311	REC57610-96311	505-507
43711-97E00	REC43711-97E11	466	55321-87J01	CM55321-87J00A	439-440-441	57621-87J00	REC57621-94403	522
43711-97E11	REC43711-97E11	466	55321-87J01	TEN01213	478	57621-87J01	REC57621-94403	522
48500-95550-OED	PH200-T027	461	55321-87J01	TEN01213	478	57621-87J02	REC57621-94403	522
48500-95680-OED	PH200-T027	461	55321-90J01	CM55321-90J01	477-512-515-516	57621-87J03	REC57621-94403	509-511-522
48503-93J10	REC48503-93J12	462	55321-90J01	CM55321-90J01A	477	57621-91L10	REC57621-91L10	522
48503-93J12	REC48503-93J12	462	55321-90J01	TEN01212	478	57621-94400	REC57621-94403	522
48503-94900-OED	REC48503-93J12	462	55321-90J01	TEN01212	478	57621-94403	REC57621-94403	522-531
48600-94511-OED	REC18-6865	462	55321-93900	CM55321-93900	501	57621-96300	REC57621-91L10	522
48630-92J00	REC48630-92J00	463	55321-93900	TEN01206	478	57621-96310	REC57621-91L10	522
48630-93J00	REC48630-93J00	463	55321-93J00	REC09116-06094	479	57630-92E00	REC57630-92E00	517-518-531
48630-94900	REC48630-94900	463	55321-94502	TEN01209	479	57630-94300	REC57630-94300	511-531
48630-96J00	REC48630-96J00	463	55321-94900	REC09116-06121	479	57630-94301	REC57630-94300	509-531
48630-96J01	REC48630-96J03	463	55321-95500	TEN01207	478	57630-94500	REC57630-94500	512-531
48630-96J02	REC48630-96J03	463	56120-90L00-OEP	REC56120-93900	521	57630-96300	REC57630-96300	505-507-531
48630-96J03	REC48630-96J03	463	56120-90L01-OEP	REC56120-93900	521	57631-93901	REC57631-93901	499-501-503-523
48630-98L00	REC48630-98L01	463	56120-90L02-OEP	REC56120-93900	521	57631-94700	REC57631-95303	523
48630-98L01	REC48630-98L01	463	56120-93900-002M	REC56120-93900	521	57631-95301	REC57631-95303	523
51123-87L00	REC51123-87L00	482-486	56120-93900-OEP	REC56120-93900	521	57631-95302	REC57631-95303	523
51123-93J00	REC51123-93J00	485	56120-93901-OED	REC56120-93900	521	57631-95303	REC57631-95303	509-511-523
51142-93J00	REC51142-93J00	485	56120-93901-OEP	REC56120-93900	501	57631-96301	REC57631-96301	507-523
51211-87J00	REC51211-87J00	481-484	56120-93901-OEP	REC56120-93900	531	57632-93902	REC57632-94J00	501
51211-87L00	REC51211-87L10	482-484	56120-94321-OEP	REC56120-94321-OEP	509-511-521	57632-94J00	REC57632-94J00	499-503-532
51211-87L10	REC51211-87L10	482-484	56120-96332-OEP	REC56120-96332-OEP	505-507-521	57632-97L00	REC57632-97L00	503-522
51211-90J00	REC51211-90J10	484	56130-94411-OEP	REC56130-94413-OEP	472	57632-98500	REC57632-97L00	522
51211-90J01	REC51211-90J10	484	56130-94413-OEP	REC56130-94413-OEP	472	57632-98501	REC57632-97L00	497-522
51211-90J02	REC51211-90J10	484	56130-96320-OEP	REC56130-96331-OEP	472	57633-93900	REC57633-93901	532
51211-90J10	REC51211-90J10	484	56130-96331-OEP	REC56130-96331-OEP	472	57633-93901	REC57633-93901	499-501-503-532
51211-90J21	REC51211-90J2	484	57100-93902	REC57100-93902	501	57634-88L00	REC57634-88L00	509-511-522
51211-90J22	REC51211-90J2	484	57100-93902	REC57100-93902	531	58100-89L00-019	SOL4111-093-07A	528
51211-93J00	REC51211-93J00	484	57110-92L10	REC57110-94411	531	58100-89L20-019	SOL4111-093-09A	528
52113-93901	REC52113-93910	495	57110-93912	REC57110-93912	531	58100-89L50-019	SOL4111-093-12A	528
52113-96304	REC52113-96330	495	57110-94441	REC57110-94441	531	58100-89L60-019	SOL4111-093-10A	528
52331-87L00	REC52331-87L00	482-494	57292-94300	PAGB/T896-6	466	58100-89L70-019	SOL4111-093-11A	528
55120-87801	TEN01211	478	57310-93850	REC57521-93902	526	58100-90J00-019	SOL3411-139-17	528
55122-88L00	REC55122-94400	473-511	57310-94401	REC57521-94400	526	58100-90J00-019	SOL3413-138-17	528
55125-87801	CM55125-87D00	477	57311-90L00	REC57311-93910	525	58100-90J00-019	SOL3451-139-17	528
55125-87801	CM55125-87D00A	477	57311-91J00	REC57311-98600	497	58100-90J10-019	SOL3411-139-19	528
55125-87D00	TEN01211	478	57311-91L00	REC57311-96311	525	58100-90J10-019	SOL3413-138-19	528
55125-87E01	CM55125-95500	477	57311-91L00	REC57311-96311	531	58100-90J10-019	SOL3451-139-19	528
55125-87E01	CM55125-95500A	477	57311-93901	REC57311-93901	525	58100-90J10-019	SOL3411-139-21	528
55125-90J01	TEN01215	478-512-513-515-516	57311-93901	REC57311-93901	531	58100-90J20-019	SOL3411-139-21	528
55125-94400	CM55125-94400	511	57311-93910	REC57311-93910	501-525	58100-90J20-019	SOL3451-139-21	528
55125-94502	CM55125-94502	477	57311-93910	REC57311-93910	525	58100-90J22-019	SOL3451-139-23	528
55125-94502	TEN01209	479	57311-94401	REC57311-94402	525	58100-90J40-019	SOL3413-138-15	528
55125-95301	CM55125-95301A	477	57311-94402	REC57311-94402	525	58100-90L41-019	SOL4111-093-08A	528
55125-95301	TEN01201	478	57311-94402	REC57311-94402	531	58100-94302-019	SOL4311-121-09	528
55125-95500	CM55125-95500	509	57311-96310	REC57311-96311	525	58100-94313-019	SOL4311-116-13	528
55125-96310	CM55125-96310	477-505-507	57311-96311	REC57311-96311	525	58100-94313-019	SOL4411-135-15	528
55125-96310	CM55125-96310A	477	57311-96320	REC57311-96320	505-507-531	58100-94500-019	SOL4413-130-15	528
55125-96310	TEN01200	478	57311-96320	REC57311-96320	503	58100-94500-019	SOL4431-135-15	528
55125-98J00	TEN01215	517	57311-97J10	REC57311-99J10	531	58100-94512-019	SOL4411-133-17	528
55128-93J00	REC55128-93J10	521	57311-98400	REC57311-98400	531	58100-94512-019	SOL4413-128-17	528
55128-93J10	REC55128-93J10	517-521	57311-98600	REC57311-98600	525	58100-94512-019	SOL4431-133-17	528
55300-95500	CM55300-95500	476-499-501-507-509-511	57311-98601	REC57311-98600	525	58100-94522-019	SOL4411-130-19	528
55300-95500	CM55300-95500A	476	57311-99J10	REC57311-99J10	499-525	58100-94522-019	SOL4413-125-19	528
55300-95500	TEN01208	478	57510-89J00	REC57510-89J00	505-507-525	58100-94522-019	SOL4431-130-19	528
55320-93900	CM55125-87D00	477	57510-90L00	REC57510-93910	525	58100-94522-019	SOL4411-130-21	528
55320-93900	CM55125-87D00A	477	57510-91J00	REC57510-91J00	497-525	58100-94532-019	SOL4413-125-21	528
55320-93900	CM55321-93900	477	57510-91L00	REC57510-89J00	525-531	58100-94532-019	SOL4413-125-21	528
55320-93900	CM55321-93900A	477	57510-93902	REC57510-93902	525	58100-94532-019	SOL4431-130-21	528
55320-94900	CM55321-94900	476	57510-93902	REC57510-93902	531	58100-94554-019	SOL4431-135-15	528
55320-94900	CM55321-94900A	441	57510-93910	REC57510-93910	501-525	58100-94561-019	SOL4431-130-19	528
55320-94900	CM55321-94900A	476	57510-93910	REC57510-93910	531-532	58100-94571-019	SOL4431-130-21	528
55320-94900	TEN01214	478	57510-94400	REC57510-94402	525	58100-94581-019	SOL4431-133-17	528
55320-94900	TEN01214AL	478	57510-94401	REC57510-94402	525	58100-95212-019	SOL4311-120-10	528
55320-95310	CM55320-95310	476	57510-94402	REC57510-94402	525	58100-95222-019	SOL4311-118-11	528
55320-95310	CM55320-95310A	476	57510-94402	REC57510-94402	531	58100-95353-019	SOL4311-116-14	528
55320-95310	TEN01204	478	57510-98600	REC57510-91J00	525	58100-95363-019	SOL4311-110-15	528
55320-95310	TEN01204AL	478	57510-98610	REC57510-91J00	525	58100-95393-019	SOL4311-116-12	528
55320-95311	CM55320-95310	517	57510-98611	REC57510-91J00	525	58100-95511-019	SOL2431-135-15	528
55320-98311	TEN01204	478	57510-99J10	REC57510-99J11	503	58100-95521-019	SOL2431-133-17	528
55320-98311	TEN01204AL	478	57521-89J00	REC57521-89J00	505-507-526-531	58100-95530-019	SOL2431-130-19	528
55320-98400	CM55320-98400	476	57521-90L00	REC57521-93910	526	58100-95D00-019	SOL4211-100-14	528
55320-98400	CM55320-98400A	476	57521-91J00	REC57521-91J00	497-526	58100-96410-019	SOL4211-110-09	528
55320-98400	TEN01210	478	57521-93902	REC57521-93902	526	58100-96420-019	SOL4211-105-11	528
55320-98600	CM55320-98600	477	57521-93902	REC57521-93902	531	58100-96430-019	SOL4211-103-12	528
55320-98600	CM55320-98600A	477	57521-93910	REC57521-93910	501-526-531	58100-96440-019	SOL4211-101-13	528
55320-98600	TEN01202	478	57521-94400	REC57521-94400	526	58100-96460-019	SOL4211-100-15	528
			57521-94400	REC57521-94400	531	58110-91JN0-019	SOL4011-079-07S	497-528

R.O. / OEM	REF		R.O. / OEM	REF	
58200-87D01-019	SOL4513-145-17	529	94702-00372	NGKCR6HSB	64-173-179
58200-87D01-019	SOL4551-148-18	529	94702-00372-00	NGKCR6HS	108
58200-87D02-019	SOL4552-148-18	529	94702-00391	NGKLF5A-11	69-70-71-72-209-211
58200-87D11-019	SOL4513-143-19	529	94702-00391-00	NGKLF5A-11	108
58200-87D11-019	SOL4551-148-20	529	94702-00400	NGKLF6A-11	70-72-73-213-214
58200-87D12-019	SOL4552-148-20	529	94702-00400-00	NGKLF6A-11	108
58200-87D21-019	SOL4513-140-21	529	94702-00409	NGKCR9EB	108
58200-87D21-019	SOL4551-143-22	529	94702-00418	NGKDPR6EB-9	65-66-67-68-69-187-195-201-203
58200-87D22-019	SOL4552-143-22	529	94702-00418-00	NGKDPR6EB-9	108
58200-87D61-019	SOL4511-150-15	529	990A0-01E81-01Q	REC80W90U3	450
58200-87D61-019	SOL4513-148-15	529	990A0-01E81-05Q	REC80W90U6	450
58200-87D61-019	SOL4551-148-16	529	990C0-01E30-GLN	REC10W40U3	450
58200-87D62-019	SOL4552-148-16	529	990C0-01E30-GLN	REC10W40U6	450
59178-97J00	REC59178-97J00	439-440-499-503-521	990C0-10W40-1GL	REC10W40U3	450
63610-89E01-000	REC63610-89E01	467	990C0-10W40-1GL	REC10W40U6	450
63610-91J00	REC63610-91J20	467	990C0-10W40-1GL	REC10W40U3	450
63610-91J01	REC63610-91J20	467	990C0-10W40-GAL	REC10W40U3	450
63610-91J03	REC63610-91J20	467	990C0-10W40-GAL	REC10W40U6	450
63610-91J04	REC63610-91J20	467	990C0-10W40-GLN	REC10W40U3	450
63610-91J20	REC63610-91J20	467	990C0-10W40-GLN	REC10W40U6	450
63610-93501-000	REC63610-93501	467	99105-00100-16P	SOL4431-135-15	528
63610-94402-000	REC63610-94402	467	99105-00100-18P	SOL4431-133-17	528
63610-96302-000	REC63610-96302	467	99105-00100-20P	SOL4431-130-19	528
63610-96321-000	REC63610-96321-000	467	99105-00100-22P	SOL4431-130-21	528
65720-94403	GS31039	444	99105-00200-16P	SOL4511-150-15	529
65720-94411	GS31038	444	99105-00200-16P	SOL4551-148-16	529
65720-98500	REC65720-98520	443	99105-00200-18P	SOL4511-148-17	529
65720-98501	REC65720-98520	443	99105-00200-18P	SOL4511-155-17	529
65720-98502	REC65720-98520	443	99105-00200-18P	SOL4551-148-18	529
65720-98520	REC65720-98520	443	99105-00200-20P	SOL4511-145-19	529
65720-98521	REC65720-98520	443	99105-00200-20P	SOL4511-153-19	529
65720-985L1	REC65720-98520	443	99105-00200-20P	SOL4551-148-20	529
65720-986A0	REC65720-986L0	443	99105-00200-22P	SOL4511-143-21	529
65720-986B0	REC65720-986L0	443	99105-00200-22P	SOL4511-153-21	529
65720-986L0	REC65720-986L0	443	99105-00200-22P	SOL4551-143-22	529
65740-95D00	GS31070	444	99105-00200-24P	SOL4511-142-23	529
65740-99100	GS31037	444	99105-00200-24P	SOL4551-140-24	529
65750-89J11	GS31089	444	99105-0020L-16P	SOL4512-150-15	529
65750-94401	REC65750-94404	443	99105-0020L-16P	SOL4552-148-16	529
65750-94402	REC65750-94404	443	99105-0020L-18P	SOL4512-148-17	529
65750-94403	REC65750-94404	443	99105-0020L-18P	SOL4552-148-18	529
65750-94404	REC65750-94404	443	99105-0020L-20P	SOL4512-145-19	529
65750-95500	GS31071	444	99105-0020L-20P	SOL4552-148-20	529
65750-95500	GS31072	444	99105-0020L-22P	SOL4512-143-21	529
65750-98505	GS31035	444	99105-0020L-22P	SOL4552-143-22	529
65750-98505	GS31036	444	99105-0020L-24P	SOL4512-142-23	529
65770-93J12	GS31095	442	99105-0020L-24P	SOL4552-140-24	529
65770-95504	GS31090	442	99105-00700-18P	SOL3451-139-17	528
65900-98J00	REC90794-46866	446	99105-00700-20P	SOL3451-139-19	528
65910-98J00	REC90794-46868	446	99105-00700-22P	SOL3451-139-21	528
67200-88L00	REC67200-88L00	465	99105-00700-24P	SOL3451-139-23	528
67200-88L10	REC67200-88L10	465	99105-0070L-18P	SOL3452-139-17	528
67200-91J00	REC67200-94J20	464	99105-0070L-20P	SOL3452-139-19	528
67200-91J01	REC67200-94J20	464	99105-0070L-22P	SOL3452-139-21	528
67200-91J04	REC67200-94J20	464	99105-11002-008	PRE3300C08	467
67200-93J00	REC67200-93J51	464	99105-11002-009	PRE3300C09	467
67200-93J01	REC67200-93J51	464	99105-11002-010	PRE3300C10	467
67200-93J02	REC67200-93J51	464	99105-11002-011	PRE3300C11	467
67200-93J03	REC67200-93J51	464	99105-11002-012	PRE3300C12	467
67200-93J04	REC67200-93J51	464	99105-11002-013	PRE3300C13	467
67200-93J06	REC67200-93J51	464	99105-11002-014	PRE3300C14	467
67200-93J12	REC67200-88L00	465	99105-11002-015	PRE3300C15	467
67200-93J13	REC67200-88L00	465	99105-11002-016	PRE3300C16	467
67200-93J15	REC67200-88L10	465	99105-11002-017	PRE3300C17	467
67200-93J50	REC67200-93J51	464	99105-11002-018	PRE3300C18	467
67200-93J51	REC67200-93J51	464	99105-11002-019	PRE3300C19	467
67200-94J20	REC67200-94J20	464	99105-11002-020	PRE3300C20	467
67200-99E10-0EP	REC67200-99E56	464	99105-11002-021	PRE3300C21	467
67200-99E30-0EP	REC67200-99E56	464	99105-11002-022	PRE3300C22	467
67200-99E50	REC67200-99E56	464	99105-11002-023	PRE3300C23	467
67200-99E51	REC67200-99E56	464	99105-11002-024	PRE3300C24	467
67200-99E56	REC67200-99E56	464	99105-11002-025	PRE3300C25	467
67256-95600	PAF15-13010010W	466	99105-11002-026	PRE3300C26	467
67275-95600	PAF25-07000007W	466	99105-11002-027	PRE3300C27	467
90171-18M04	REC90171-18M04	518	99105-11002-028	PRE3300C28	467
92800-94610	REC32800-94620	458	99105-11002-029	PRE3300C29	467
94701-00282	NGKCR6HS	181	99105-11002-030	PRE3300C30	467
94701-00282-00	NGKCR6HS	108	99105-20003	RACRK22628	447
94701-00300-00	NGKCR5HSB	108	99105-20005	LENS3227	446
94701-00309-00	NGKBR9HS-10	108	99105-20005	RACS3227	446
94701-00375	NGKDPR6EA-9	65-66-67-68-197-207	99105-20005-ASY	RAC490R-RAC-01	446
94701-00375	NGKDPR7EA-9	185-191			
94701-00375-00	NGKDPR6EA-9	108			
94701-00406-00	NGKDPR5EA-9	69-108			
94702-00247-00	NGKBR8HS-10	108			
94702-00271	NGKBR8HS-10	247-456			
94702-00309	NGKBR9HS-10	245			



# HONDA

## ES

GUÍA MANTENIMIENTO COLAS Y Y KITS	545	DESCONECTORES DE SEGURIDAD	561	JUNTAS BASE DE MOTOR	574
<b>SISTEMA DE ALIMENTACIÓN Y FILTRACIÓN</b>	547	LLAVES DE ARRANQUE	564	JUNTAS BOMBA DE ACEITE	574
ACEITE	553	MOTORES DE ARRANQUE	560	JUNTAS CULATA	574
BOMBA DE COMBUSTIBLE EN LÍNEA	547	<b>SENSORES</b>	557	JUNTAS SILENCIOSO	574
ABRAZADERA PARA MANGUERA	548	SENSOR DETONACIÓN	558	JUNTAS TAPÓN DRENAJE	575
ADAPTADOR LÍNEA DE COMBUSTIBLE	548	SENSOR MAP	557	KIT JUNTAS DE CULATA	575
BOMBA DE COMBUSTIBLE	547	SENSOR MAT, TEMPERATURA DEL AIRE	558	<b>SISTEMA DE ESCAPE Y ADMISIÓN</b>	576
LÍNEA DE COMBUSTIBLE	547	SENSOR POSICIÓN CIGÜEÑAL	557	<b>SISTEMA DE ADMISIÓN</b>	576
MANGUERA DE COMBUSTIBLE	547	SENSOR POSICIÓN LEVAS	557	JUNTAS	576
MUELLE TUBO COMBUSTIBLE	548	SENSOR PRESIÓN DE ACEITE	558	RETÉN DE VÁLVULA	576
BOMBA DE COMBUSTIBLE ELÉCTRICA	555	SENSOR OXÍGENO	558	<b>SISTEMA DE ESCAPE</b>	576
CARBURADOR	555	TRIM, TILT & POWER TRIM	562	RETÉN DE VÁLVULA	576
AGUJA DE CARBURADOR	555	EXTRACTOR TAPONES DE TRIM	563	<b>UNIDADES DE TRANSMISIÓN</b>	577
GUÍA CARBURADORES	556	INSTALACIÓN ELÉCTRICA	562	<b>DESPIECE COLAS</b>	577
KITS CARBURADORES	556	POWER TRIM COMPLETO	563	BF75AT • BF90AT	577
<b>COMPONENTES TANQUE Y CONECTORES</b>	548	TRIM COMPLETO	562	<b>COMPONENTES DE COLA</b>	578
CONECTOR DE DEPÓSITO	548	<b>SISTEMA DE GOBIERNO</b>	564	ARANDELA DE CIERRE	579
PASAMAMPAROS	549	<b>CABLES DE CONTROL</b>	565	EJE HÉLICE	579
<b>FILTRO DE ACEITE</b>	554	LLAVES DE ARANQUE	565	JUNTA EJE SELECTOR	578
GUÍA FILTROS DE ACEITE	554	MANDOS DE CONTROL	564	KITS JUNTAS Y RETENES	578
<b>FILTRO DE COMBUSTIBLE Y ELEMENTOS</b>	549	<b>SISTEMA DE REFRIGERACIÓN</b>	566	RETENES EJE DE CAMBIO	578
BRACKET	549	<b>ÁNODOS</b>	571	RETENES EJE DE HELICE	578
FILTRO COMBUSTIBLE MONTAJE EN LÍNEA	552	ÁNODO CANADA METAL	571	RETENES EJE DE TRANSMISIÓN	578
FILTRO COMBUSTIBLE SEPARADOR AGUA	549	ÁNODO TECNOSEAL	573	RODAMIENTO DIÁBOLO	579
FILTRO DECANTADOR DE COMBUSTIBLE COMPLETO CON VASO TRANSPARENTE	550	BOMBA DE AGUA	569	RODAMIENTO PIÑÓN AVANTE	579
FILTRO DECANTADOR DE GASOLINA	550	JUNTAS BOMBA	569	TUERCA DE DIÁBOLO	579
LLAVES PARA FILTRO	552	KITS DE REPARACIÓN BOMBA DE AGUA	570	<b>SISTEMA DE PROPULSIÓN</b>	580
RACOR DE LATÓN	552	RETÉN CUERPO DE BOMBA	570	<b>HÉLICES ALUMINIO E INOXIDABLE DE 3 Y 4 PALAS</b>	580
<b>INYECTORES</b>	555	<b>IMPULSORES</b>	567	GUÍA HÉLICES CON NÚCLEO INTEGRADO	581
<b>SISTEMA ELÉCTRICO</b>	557	CHAVETA	569	HÉLICES PARA NÚCLEO INTERCAMBIABLE	582
<b>ALTERNADORES</b>	561	GUÍA IMPULSORES	568	NÚCLEO INTERCAMBIABLE	582
CORREAS DE ALTERNADOR	562	TERMOSTATO	566	REF --> RO	583
BOBINAS	559	<b>PARTES DEL MOTOR</b>	574	RO --> REF	585
BUJÍAS	559	GUÍA CORREAS DE DISTRIBUCIÓN	575		
		JUNTAS DE MOTOR	574		

## EN

DRIVES MAINTENANCE GUIDE & KITS	545	<b>SENSORS</b>	557	<b>ENGINE PARTS</b>	574
<b>FUEL &amp; FILTRATION SYSTEM</b>	547	SENSOR, CAMSHAFT	557	<b>ENGINE GASKETS</b>	574
<b>CARBURETOR</b>	555	SENSOR, CRANKSHAFT	557	GASKET, CYLINDER	574
CARBURETOR KITS	556	SENSOR, KNOCK	558	GASKET, CYLINDER HEAD	574
CARBURETOR NEEDLE VALVE	555	SENSOR, MAP	557	GASKET KIT	575
GUIDE CARBURETORS	556	SENSOR MAT, AIR TEMPERATURE	558	GASKET, MUFFLER	574
<b>ELECTRIC FUEL PUMP</b>	555	SENSOR, O2	558	GASKET, OIL PUMP	574
<b>FUEL FILTERS AND ELEMENTS</b>	549	SENSOR, PRESSURE OIL	558	O-RING, DRAIN CAP	575
BRACKET	549	SPARK	559	<b>TIMING BELT</b>	574
COMPLETE FUEL FILTER	550	<b>STARTERS</b>	560	<b>EXHAUST &amp; INTAKE SYSTEM</b>	576
COMPLETE FUEL FILTER WITH TRANSPARENT BOWL	550	TRIM, TILT & POWER TRIM	562	<b>EXHAUST SYSTEM</b>	576
FILTER KEY	552	COMPLETE POWER TRIM ASSEMBLY	563	VALVE SEALS	576
IN-LINE FUEL FILTER	552	COMPLETE TRIM ASSEMBLY	562	<b>INTAKE SYSTEM</b>	576
RACORS	552	TRIM PLUGS EXTRACTOR	563	GASKETS & VALVE SEALS	576
WATER SEPARATING FUEL FILTER	549	WIRING HARNESS	561	<b>UNIT DRIVES &amp; COMPONENTS</b>	577
<b>FUEL PUMP IN LINE</b>	547	<b>STEERING SYSTEM</b>	564	<b>DRIVE COMPONENTS</b>	577
CLAMP SMALL	548	<b>ENGINE CONTROLS</b>	564	CARRIER BEARING	579
COUPLER	548	CONSOLE CONTROL	564	FORWARD GEAR BEARING	579
FUEL HOSE	547	CONTROL CABLES	565	NUT, GEARCASE END	579
FUEL LINE ASSEMBLY	547	SIDE CONTROL	564	O-RING DRIVE SHAFT	578
SPRING, FUEL PIPE	548	<b>IGNITION STARTER SWITCH</b>	565	PROPELLER SHAFT	579
<b>FUEL TANK COMPONENTS &amp; CONNECTORS</b>	548	<b>COOLING SYSTEM</b>	566	SEAL DRIVE SHAFT	578
TANK CONNECTOR	548	<b>ANODES</b>	571	SEAL KITS	578
THRU HULL	549	ANODES CANADA METAL	571	SEAL PROPELLER SHAFT	578
<b>INYEKTOR</b>	555	ANODES TECNOSEAL	573	TAB WASHER	579
<b>OIL</b>	553	<b>IMPELLERS</b>	567	<b>PROPULSION SYSTEM</b>	580
<b>OIL FILTER</b>	554	IMPELLERS GUIDE	568	<b>3 &amp; 4 BLADE ALUMINIUM &amp; SS PROPELLERS</b>	580
OIL FILTER GUIDE	554	KEY	569	INTERCHANGEABLE HUB	582
<b>ELECTRIC SYSTEM</b>	557	TERMOSTAT	566	PROPELLERS APPLICATION WITH RUBBER HUB	581
<b>ALTERNATOR</b>	561	<b>WATER PUMP</b>	569	PROPELLERS FOR INTERCHANGEABLE HUB	582
ALTERNATOR BELT	562	SEAL WATER PUMP	570	REF --> OEM	583
COILS	559	SERVICE KIT	570	OEM --> REF	585
CUT OFF SWITCHES	561	WATER PUMP GASKET	569		

GUIDA MANUTENZIONE E KIT	545	MOTORINI AVVIAMENTO	560	GUARNIZIONE TAPPO DRENAGIO	575
<b>SISTEMA DI ALIMENTAZIONE E FILTRAZIONE</b>	547	SENSORE	557	GUARNIZIONE OLIO	574
CARBURATORE	555	SENSORE ALBERO A CAME	557	GUARNIZIONE SILENZIATORE	574
KIT CARBURATORI	556	SENSORE ALBERO MOTORE	557	GUARNIZIONE TESTATA	574
SPILLO CONICO CARBURATORE	555	SENSORE ANTIDETONAZIONE	558	KIT GUARNIZIONE TESTATA	575
COMPONENTI SERBATOIO E CONETTORI	548	SENSORE MAP	557	<b>GUIDA CINGHIE DISTRIBUZIONE</b>	575
ATTACCO SERBATOIO	548	SENSORE MAT, TEMPERATURA ARIA	558	<b>SISTEMA DI SCARICO E ASPIRAZIONE</b>	576
PASSASCAFO	549	SENSORE OSSIGENO	558	<b>SISTEMA ASPIRAZIONE</b>	576
<b>FILTRI BENZINA E RACCORDI</b>	549	SENSORE PRESSIONE DELL'OLIO	558	GUARNIZIONE	576
CHIAVE DA FILTRO	552	TRIM, TILT & POWER TRIM	562	TENUTE	576
FILTRO BENZINA ALTA PRESSIONE		ESTRATTORE PER TAPPI DI TRIM	563	<b>SISTEMA SCARICO</b>	576
FILTRO BENZINA PER MONTARE IN LINEA	552	INSTALLAZIONE ELETTRICA	562	TENUTE	576
FILTRO DECANATORE BENZINA	550	MOTORINO POWER TRIM COMPLETO	563		
FILTRO DI DECANAZIONE BENZINA COMPLETO CON VASCETTA TRASPARENTE	550	MOTORINO TRIM COMPLETO	562	<b>UNITÀ DI TRASMISSIONE</b>	577
FILTRO SEPARATORE ACQUA-BENZINA	549	<b>SISTEMA DI GUIDA</b>	564	<b>COMPONENTI PIEDI</b>	578
RACCORDI	552	CAVI COMANDI	565	ASSE ELICA	579
SUPPORTO	549	COMANDI DI CONTROLLO	564	CUSCINETTO DIAVOLO	579
<b>FILTRO OLIO</b>	554	CHIAVI DI ACCENSIONE	565	CUSCINETTO PIGNONE AVANTI	579
GUIDA FILTRO OLIO	554	<b>SISTEMA DI RAFFREDDAMENTO</b>	566	DADO DIAVOLO	579
INIETTORE	555	ANODI	571	KIT GUARNIZIONE E TENUTE	578
OLIO	553	ANODI CANADA METAL	571	TENUTE ASSE DI CAMBIO	578
POMPA BENZINA ELETTRICA	555	ANODI TECNOSEAL	573	TENUTE ASSE DI ELICA	578
POMPA BENZINA IN LINEA	547	<b>GIRANTE</b>	567	TENUTE ASSE DI TRASMISSIONE	578
ADATTATORE	548	CIAVETTA	569	RONDELLA CHIUSURA	579
FASCETTE	548	GUIDA GIRANTE	568	<b>PARTI PIEDI</b>	577
MOLLA TUBO COMBUSTIBILE	548	<b>POMPA ACQUA</b>	569	BF75AT • BF90AT	577
TUBO BENZINA	547	GUARNIZIONE POMPA	569	<b>SISTEMA DI PROPULSIONE</b>	580
TUBO CARBURANTE	547	KIT RICAMBI POMPA ACQUA	570	<b>HELICHE ALLUMINIO E INOX DA 2 E 4 PALE</b>	580
<b>SISTEMA ELETTRICO</b>	557	TENUTE CORPO POMPA	570	ELICHE PER MOZZO INTERCAMBIABILE	582
ALTERNATORE	561	TERMOSTATO	566	GUIDA ELICHE CON MOZZO	581
CURROIA ALTERNATORE	562	<b>PARTI MOTORE</b>	574	MOZZO INTERCAMBIABILE	582
BOBINE	559	GUARNIZIONI MOTORE	574	REF --> RO	583
CANDELE	559	GUARNIZIONE BASE MOTORE	574	RO --> REF	585
CHIAVETTA DI SICUREZZA	561				
INTERRUTTORE DI STOP	561				
KIT	561				

GUIDE KITS DE MAINTENANCE	545	CAPTEUR DE CLIQUETIS	558	JOINTS DE POMPE À HUILE	574
<b>SYSTÈME D'ALIMENTATION ET DE FILTRATION</b>	547	CAPTEUR DE POSITION D'ARBRE À CAMES	557	JOINTS DE SILENCIEU	574
CARBURATEUR	555	CAPTEUR DE POSITION DU VILEBREQUIN	557	JOINTS DE VIDANGE	575
GUIDE DES CARBURATEURS	556	CAPTEUR MAP	557	KIT JOINTS DE MOTEUR	575
KIT CARBURATEUR	556	CAPTEUR MAT DE TEMPERATURE D'AIR	558	<b>SYSTÈME D'ÉCHAPPEMENT ET SYSTÈME D'ADMISSION</b>	576
POINTEAU CARBURATEUR	555	CAPTEUR PRESSION D'HUILE	558	<b>SYSTÈME D'ADMISSION</b>	576
COMPONENTS ET CONNECTEURS DU RÉSERVOIR	548	COUPE CIRCUIT DE SECURITE	561	JOINTS DE SOUPAPE	576
PASSE-CLOISON	549	KITS	561	<b>SYSTÈME D'ÉCHAPPEMENT</b>	576
RACCORDS DE RESERVOIR	548	DEMARREUR	560	JOINTS DE SOUPAPE	576
FILTRE À ESSENCE ET CARTOUCHE DE RECHANGE	549	TRIM, TILT & POWER TRIM	562	<b>EMBASSES ET PIÈCES</b>	577
CLÉ À FILTRE	552	INSTALLATION ELECTRIQUE	562	EMBASSES	577
FILTRE À ESSENCE EN LIGNE	552	KIT EXTRACTEUR	563	BF75AT • BF90AT	577
FILTRE DÉCANTEUR ESSENCE	550	MOTEUR DE TRIM	562	<b>PIÈCES</b>	578
FILTRE DÉCANTEUR ESSENCE AVEC BOL TRANSPARENT	550	POWER TRIM COMPLET	563	ARBRE D'HELICE	579
FILTRE SÉPARATEUR EAU-ESSENCE	549	<b>SYSTÈME DE COMMANDE</b>	564	ÉCROU DE DIABOLO	579
RACCORDS	552	BOITIER DE COMMANDE	564	JOINTS D'ARBRE DE SELECTEUR	578
TÊTE DE FILTRE À ESSENCE	549	CÂBLES DE COMMANDE	565	JOINTS SPI ARBRE DE CHANGEMENT	578
<b>FILTRE À HUILE</b>	554	CONTACTEUR À CLÉ	565	JOINTS SPI ARBRE DE TRASMISSION	578
GUIDE DES FILTRES À HUILE	554	<b>SYSTÈME DE REFROIDISSEMENT</b>	566	KITS JOINTS D'EMBASSES	578
<b>HUILES</b>	553	ANODES	571	RONDELLE FREIN	579
INJECTEURS	555	ANODE CANADA METAL	571	ROULEMENT DE DIABOLO	579
POIRE À CARBURANT	547	ANODE TECNOSEAL	573	ROULEMENT DE PIGNON AVANT	579
COLLIER	548	<b>TURBINES</b>	567	<b>SYSTEME DE PROPULSION</b>	580
RACCORD COUPLEUR	548	CLAVETTE	569	<b>HELICE ALUMINIUM ET INOX 3 ET 4 PALES</b>	580
RESSORT, TUYAU DE CARBURANT	548	GUIDE DE TURBINES	568	GUIDE DES HÉLICES ET MOYEUX	581
TUYAU CARBURANT	547	<b>POMPE D'EAU</b>	569	HELICES AVEC MOYEU INTERCHANGEABLE	582
<b>POMPE À ESSENCE ÉLECTRIQUE</b>	555	JOINTS SPI DE POMPE À EAU	570	MOYEU INTERCHANGEABLE	582
<b>SYSTÈME ÉLECTRIQUE</b>	557	JOINTS POMPE	569	REF --> RO	583
ALTERNATEUR	561	KIT REPARATION DE POMPE À EAU	570	RO --> REF	585
COURROIE D'ALTERNATEUR	562	TERMOSTAT	566		
BOBINES	559	<b>PIÈCES MOTEUR</b>	574		
BOUGIES	559	COURROIES DE DISTRIBUTION	575		
CAPTEURS	557	JOINTS DE MOTEUR	574		
CAPTEUR À OXYGENE	558	JOINTS DE CULASSE	574		
		JOINTS DE TÊTE MOTRICE	574		



**GUÍA KITS MANTENIMIENTO**    
 **MAINTENANCE GUIDE & KITS**    
**GUIDA MANUTENZIONE E KIT**    
**GUIDE KITS MAINTENANCE**

	KIT	REF						
BF4 BF4.5 BF5		REC06211-ZV1-505	REC06192-ZV1-C00	KIT TURBINA	IMPELLER KIT	KIT GIRANTE	KIT TURBINE	1
		NGKBPR5ES		BUJÍA	SPARK PLUG	CANDELE	BOUGIE	1
		REC19300-881-761		TERMOSTATO	THERMOSTAT	TERMOSTATO	TERMOSTAT	1
		REC16910-GB2-005		FILTRO COMBUSTIBLE	FUEL FILTER	FILTRO COMBUSTIBILE	FILTRE À ESSENCE	1
		TEN01402		ÁNODO	ANODE	ANODO	ANODE	1
		PAGB/T91-2.5X30		PIN	PIN	PIN	GOUPILLE	1
BF8 BF9.9D BF10		REC06211-ZW9-505	REC19210-ZW9-013	TURBINA	IMPELLER	GIRANTE	TURBINE	1
		NGKCR5EH-9		BUJÍA	SPARK PLUG	CANDELE	BOUGIE	2
		PAF15-07000031		TERMOSTATO	THERMOSTAT	TERMOSTATO	TERMOSTAT	1
		REC16910-ZV4-015		FILTRO COMBUSTIBLE	FUEL FILTER	FILTRO COMBUSTIBILE	FILTRE À ESSENCE	1
		REC35-822626Q03		FILTRO DE ACEITE	OIL FILTER	FILTRO OLIO	FILTRE A HUILE	1
		CM41106-ZW9-09000		ÁNODO	ANODE	ANODO	ANODE	2
PAGB/T91-2.5X30		PIN	PIN	PIN	GOUPILLE	1		
BF9.9A BF15A		REC06211-ZV4-505	REC06192-ZV4-000	KIT TURBINA	IMPELLER KIT	KIT GIRANTE	KIT TURBINE	1
		REC19300-881-761		TERMOSTATO	THERMOSTAT	TERMOSTATO	TERMOSTAT	1
		NGKDR6HS		BUJÍA	SPARK PLUG	CANDELE	BOUGIE	2
		REC16910-ZV4-015		FILTRO COMBUSTIBLE	FUEL FILTER	FILTRO COMBUSTIBILE	FILTRE À ESSENCE	1
		TEN01402		ÁNODO	ANODE	ANODO	ANODE	1
		PAGB/T91-2.5X30		PIN	PIN	PIN	GOUPILLE	1
BF15D BF20D		REC06211-ZY0-505	REC06192-ZW9-A30	KIT TURBINA	IMPELLER KIT	KIT GIRANTE	KIT TURBINE	1
		PAGB/T91-2.5X30		PIN	PIN	PIN	GOUPILLE	1
		PAF15-07000031		TERMOSTATO	THERMOSTAT	TERMOSTATO	TERMOSTAT	1
		REC35-822626Q03		FILTRO DE ACEITE	OIL FILTER	FILTRO OLIO	FILTRE A HUILE	1
		NGKCR5EH-9		BUJÍA	SPARK PLUG	CANDELE	BOUGIE	2
		CM41106-ZW9-09000		ÁNODO	ANODE	ANODO	ANODE	2
BF25D BF30D		REC06211-ZV7-505	REC16910-ZV4-015	FILTRO COMBUSTIBLE	FUEL FILTER	FILTRO COMBUSTIBILE	FILTRE À ESSENCE	1
		REC35-822626Q03		FILTRO DE ACEITE	OIL FILTER	FILTRO OLIO	FILTRE A HUILE	1
		PAGB/T91-2.5X30		PIN	PIN	PIN	GOUPILLE	1
		PAF15-07000031		TERMOSTATO	THERMOSTAT	TERMOSTATO	TERMOSTAT	1
		REC06192-ZV7-000		KIT TURBINA	IMPELLER KIT	KIT GIRANTE	KIT TURBINE	1
		TEN01408/1		ÁNODO	ANODE	ANODO	ANODE	1
BF35A BF40A BF45A BF50A		REC06211-ZV5-505	REC06192-ZV5-003	KIT TURBINA	IMPELLER KIT	KIT GIRANTE	KIT TURBINE	1
		PAGB/T91-2.5X30		PIN	PIN	PIN	GOUPILLE	1
		NGKDR7EA		BUJÍA	SPARK PLUG	CANDELE	BOUGIE	3
		REC35-822626Q03		FILTRO DE ACEITE	OIL FILTER	FILTRO OLIO	FILTRE A HUILE	1
		PAF15-07000031		TERMOSTATO	THERMOSTAT	TERMOSTATO	TERMOSTAT	1
		CMHBF4050KITA		KIT ANODO	ANODE KIT	KIT ANODO	KIT ANODE	1
REC12-191833		JUNTA DRENAJE COLA	DRAIN PLUG GASKET	GUARNIZIONE DRENAGGIO	JOINT DE VIDANGE D'EMBASE	2		
PAF15-04000003		JUNTA DRENAJE COLA	DRAIN PLUG GASKET	GUARNIZIONE DRENAGGIO	JOINT DE VIDANGE D'EMBASE	1		
NGKDR7EA		BUJÍA	SPARK PLUG	CANDELE	BOUGIE	3		
REC35-822626Q03		FILTRO DE ACEITE	OIL FILTER	FILTRO OLIO	FILTRE A HUILE	1		
PAF15-07000031		TERMOSTATO	THERMOSTAT	TERMOSTATO	TERMOSTAT	1		
CMHBF4050KITA		KIT ANODO	ANODE KIT	KIT ANODO	KIT ANODE	1		
REC12-191833		JUNTA DRENAJE COLA	DRAIN PLUG GASKET	GUARNIZIONE DRENAGGIO	JOINT DE VIDANGE D'EMBASE	2		
PAF15-04000003		JUNTA DRENAJE COLA	DRAIN PLUG GASKET	GUARNIZIONE DRENAGGIO	JOINT DE VIDANGE D'EMBASE	1		
REC16900-SA5-004		FILTRO COMBUSTIBLE	FUEL FILTER	FILTRO COMBUSTIBILE	FILTRE À ESSENCE	1		

	KIT	REF								
BF40D BF50D		REC06211-ZZ3-505	REC06192-ZV5-003	KIT TURBINA	IMPELLER KIT	KIT GIRANTE	KIT TURBINE	1		
		PAGB/T91-2.5X30	PAGB/T91-2.5X30	PIN	PIN	PIN	GOUPILLE	1		
		NGKDR7EB	NGKDR7EB	BUJÍA	SPARK PLUG	CANDELE	BOUGIE	3		
		REC35-822626Q03	REC35-822626Q03	FILTRO DE ACEITE	OIL FILTER	FILTRO OLIO	FILTRE A HUILE	1		
		PAF15-07000031	PAF15-07000031	TERMOSTATO	THERMOSTAT	TERMOSTATO	TERMOSTAT	1		
		CMHBF4050KITA	CMHBF4050KITA	KIT ANODO	ANODE KIT	KIT ANODO	KIT ANODE	1		
		REC12-191833	REC12-191833	JUNTA DRENAJE COLA	DRAIN PLUG GASKET	GUARNIZIONE DRENAGGIO	JOINT DE VIDANGE D'EMBASE	2		
		PAF15-04000003	PAF15-04000003	JUNTA DRENAJE COLA	DRAIN PLUG GASKET	GUARNIZIONE DRENAGGIO	JOINT DE VIDANGE D'EMBASE	1		
		REC16911-ZZ5-003	REC16911-ZZ5-003	FILTRO COMBUSTIBLE	FUEL FILTER	FILTRO COMBUSTIBILE	FILTRE À ESSENCE	1		
		BF60A		REC06211-ZZ3-506	REC19210-ZV5-003	TURBINA	IMPELLER	GIRANTE	TURBINE	1
REC90752-ZV5-003	REC90752-ZV5-003			CHAVETA TURBINA	IMPELLER KEY	CHIAVE GIRANTE	CLAVETTE TURBINE	1		
NGKLMAR6C-9	NGKLMAR6C-9			BUJÍA	SPARK PLUG	CANDELE	BOUGIE	3		
PAGB/T91-2.5X30	PAGB/T91-2.5X30			PIN	PIN	PIN	GOUPILLE	1		
PAF15-07000031	PAF15-07000031			TERMOSTATO	THERMOSTAT	TERMOSTATO	TERMOSTAT	1		
CMHBF35225KITA	CMHBF35225KITA			KIT ANODO	ANODE KIT	KIT ANODO	KIT ANODE	1		
REC12-191833	REC12-191833			JUNTA DRENAJE COLA	DRAIN PLUG GASKET	GUARNIZIONE DRENAGGIO	JOINT DE VIDANGE D'EMBASE	2		
PAF15-04000003	PAF15-04000003			JUNTA DRENAJE COLA	DRAIN PLUG GASKET	GUARNIZIONE DRENAGGIO	JOINT DE VIDANGE D'EMBASE	1		
REC35-822626Q03	REC35-822626Q03			FILTRO DE ACEITE	OIL FILTER	FILTRO OLIO	FILTRE A HUILE	1		
REC16911-ZZ5-003	REC16911-ZZ5-003			FILTRO COMBUSTIBLE	FUEL FILTER	FILTRO COMBUSTIBILE	FILTRE À ESSENCE	1		
BF75A BF90A (1200002)		REC06211-ZW0-505	REC06192-ZV1-305	KIT TURBINA	IMPELLER KIT	KIT GIRANTE	KIT TURBINE	1		
		REC19300-ZV5-043	REC19300-ZV5-043	TERMOSTATO	THERMOSTAT	TERMOSTATO	TERMOSTAT	1		
		REC15400-RBA-F01	REC15400-RBA-F01	FILTRO DE ACEITE	OIL FILTER	FILTRO OLIO	FILTRE A HUILE	1		
		NGKDR7EA	NGKDR7EA	BUJÍA	SPARK PLUG	CANDELE	BOUGIE	4		
		PAGB/T91-2.5X30	PAGB/T91-2.5X30	PIN	PIN	PIN	GOUPILLE	1		
		REC12-191833	REC12-191833	JUNTA DRENAJE COLA	DRAIN PLUG GASKET	GUARNIZIONE DRENAGGIO	JOINT DE VIDANGE D'EMBASE	2		
		PAF15-04000003	PAF15-04000003	JUNTA DRENAJE COLA	DRAIN PLUG GASKET	GUARNIZIONE DRENAGGIO	JOINT DE VIDANGE D'EMBASE	1		
		CMHBF75115KITA	CMHBF75115KITA	KIT ANODO	ANODE KIT	KIT ANODO	KIT ANODE	1		
		REC16900-SA5-004	REC16900-SA5-004	FILTRO COMBUSTIBLE	FUEL FILTER	FILTRO COMBUSTIBILE	FILTRE À ESSENCE	1		
		BF75D BF90D		REC06211-ZY9-505	REC06192-ZV1-000	KIT TURBINA	IMPELLER KIT	KIT GIRANTE	KIT TURBINE	1
PAGB/T91-2.5X30	PAGB/T91-2.5X30			PIN	PIN	PIN	GOUPILLE	1		
NGKIZFR6K11	NGKIZFR6K11			BUJÍA	SPARK PLUG	CANDELE	BOUGIE	4		
REC15400-RBA-F01	REC15400-RBA-F01			FILTRO DE ACEITE	OIL FILTER	FILTRO OLIO	FILTRE A HUILE	1		
CMHBF75115KITA	CMHBF75115KITA			KIT ANODO	ANODE KIT	KIT ANODO	KIT ANODE	1		
REC19300-ZV5-043	REC19300-ZV5-043			TERMOSTATO	THERMOSTAT	TERMOSTATO	TERMOSTAT	1		
REC12-191833	REC12-191833			JUNTA DRENAJE COLA	DRAIN PLUG GASKET	GUARNIZIONE DRENAGGIO	JOINT DE VIDANGE D'EMBASE	2		
PAF15-04000003	PAF15-04000003			JUNTA DRENAJE COLA	DRAIN PLUG GASKET	GUARNIZIONE DRENAGGIO	JOINT DE VIDANGE D'EMBASE	1		
REC16900-SR3-004	REC16900-SR3-004			FILTRO COMBUSTIBLE	FUEL FILTER	FILTRO COMBUSTIBILE	FILTRE À ESSENCE	1		
REC16911-ZY3-010	REC16911-ZY3-010			FILTRO COMBUSTIBLE	FUEL FILTER	FILTRO COMBUSTIBILE	FILTRE À ESSENCE	1		
BF115A BF130A		REC06211-ZW5-505	REC06192-ZV1-000	KIT TURBINA	IMPELLER KIT	KIT GIRANTE	KIT TURBINE	1		
		REC15400-RBA-F01	REC15400-RBA-F01	FILTRO DE ACEITE	OIL FILTER	FILTRO OLIO	FILTRE A HUILE	1		
		NGKZFR7F	NGKZFR7F	BUJÍA	SPARK PLUG	CANDELE	BOUGIE	4		
		REC12-191833	REC12-191833	JUNTA DRENAJE COLA	DRAIN PLUG GASKET	GUARNIZIONE DRENAGGIO	JOINT DE VIDANGE D'EMBASE	2		
		PAF15-04000003	PAF15-04000003	JUNTA DRENAJE COLA	DRAIN PLUG GASKET	GUARNIZIONE DRENAGGIO	JOINT DE VIDANGE D'EMBASE	1		
		CMHBF75115KITA	CMHBF75115KITA	KIT ANODO	ANODE KIT	KIT ANODO	KIT ANODE	1		
		REC16911-ZY3-010	REC16911-ZY3-010	FILTRO COMBUSTIBLE	FUEL FILTER	FILTRO COMBUSTIBILE	FILTRE À ESSENCE	1		
		REC16900-SR3-004	REC16900-SR3-004	FILTRO COMBUSTIBLE	FUEL FILTER	FILTRO COMBUSTIBILE	FILTRE À ESSENCE	1		
		BF135A BF150A		REC06211-ZY5-505	REC06192-ZY6-000	KIT TURBINA	IMPELLER KIT	KIT GIRANTE	KIT TURBINE	1
				PAGB/T91-2.5X30	PAGB/T91-2.5X30	PIN	PIN	PIN	GOUPILLE	1
REC15400-RBA-F01	REC15400-RBA-F01			FILTRO DE ACEITE	OIL FILTER	FILTRO OLIO	FILTRE A HUILE	1		
NGKIZFR6K11	NGKIZFR6K11			BUJÍA	SPARK PLUG	CANDELE	BOUGIE	4		
REC12-191833	REC12-191833			JUNTA DRENAJE COLA	DRAIN PLUG GASKET	GUARNIZIONE DRENAGGIO	JOINT DE VIDANGE D'EMBASE	2		
PAF15-04000003	PAF15-04000003			JUNTA DRENAJE COLA	DRAIN PLUG GASKET	GUARNIZIONE DRENAGGIO	JOINT DE VIDANGE D'EMBASE	1		
CMHBF35225KITA	CMHBF35225KITA			KIT ANODO	ANODE KIT	KIT ANODO	KIT ANODE	1		
REC16911-ZY3-010	REC16911-ZY3-010			FILTRO COMBUSTIBLE	FUEL FILTER	FILTRO COMBUSTIBILE	FILTRE À ESSENCE	1		
BF175A BF200A BF225A				REC06211-ZY2-506	REC06192-ZY3-000	KIT TURBINA	IMPELLER KIT	KIT GIRANTE	KIT TURBINE	1
				REC15400-PLM-A01PE	REC15400-PLM-A01PE	FILTRO DE ACEITE	OIL FILTER	FILTRO OLIO	FILTRE A HUILE	1
		NGKIZFR6K11	NGKIZFR6K11	BUJÍA	SPARK PLUG	CANDELE	BOUGIE	6		
		PAF15-07000031	PAF15-07000031	TERMOSTATO	THERMOSTAT	TERMOSTATO	TERMOSTAT	1		
		PAGB/T91-2.5X30	PAGB/T91-2.5X30	PIN	PIN	PIN	GOUPILLE	1		
		REC12-191833	REC12-191833	JUNTA DRENAJE COLA	DRAIN PLUG GASKET	GUARNIZIONE DRENAGGIO	JOINT DE VIDANGE D'EMBASE	2		
		PAF15-04000003	PAF15-04000003	JUNTA DRENAJE COLA	DRAIN PLUG GASKET	GUARNIZIONE DRENAGGIO	JOINT DE VIDANGE D'EMBASE	1		
		CMHBF35225KITA	CMHBF35225KITA	KIT ANODO	ANODE KIT	KIT ANODO	KIT ANODE	1		
		REC16911-ZY3-010	REC16911-ZY3-010	FILTRO COMBUSTIBLE	FUEL FILTER	FILTRO COMBUSTIBILE	FILTRE À ESSENCE	1		

# SISTEMA DE ALIMENTACIÓN Y FILTRACIÓN FUEL & FILTRATION SYSTEM

# SISTEMA DI ALIMENTAZIONE E FILTRAZIONE SYSTÈME D'ALIMENTATION ET DE FILTRATION

## BOMBA DE COMBUSTIBLE FUEL PUMP POMPA BENZINA POIRE À CARBURANT

### BOMBA DE COMBUSTIBLE FUEL PUMP POMPA BENZINA POIRE À CARBURANT

Fabricada con elastómeros termoplásticos inyectados, resistentes al alcohol y rayos UV.s

Premium quality bulb resistance to alcohol as well as UV and ozone.

Fabbricata con elastomero termoplastico, resistente ai solventi e raggi UV.

Fabriqué avec des élastomères thermoplastiques injectés, résistant aux carburants et aux rayons UV.

REF		
GS31187	1/4" = 6 mm	1
GS31090	5/16" = 8 mm	1
GS31095	3/8" = 9.5 mm	1
GS31090	5/16" = 8 mm	1

**GOLDENSHIP**



## LÍNEA DE COMBUSTIBLE FUEL LINE ASSEMBLY TUBO CARBURANTE TUYAU CARBURANT

Universal. Manguera resistente al alcohol.

Universal. Alcohol resistant hose.

Universale. Tubo resistente ai solventi.

Universel. Tuyau résistant à l'alcohol.

REF		
GS31096	5/16" x 2 m	1
GS31097	3/8" x 2 m	1
GS31099	8 mm x 2 m	1
SIE18-8013	5/16" x 2 m	1
SIE18-8015	3/8" x 2 m	1



SIE18-8013  
SIE18-8015

REF		
GS31189	3/8" x 2 m	1

MADE IN THE USA **GOLDENSHIP**



REF		
GS31183	6 mm x 2 m	1

**GOLDENSHIP**

new

## MANGUERA DE COMBUSTIBLE FUEL HOSE TUBO BENZINA TUYAU CARBURANT

Manguera «Trident» para líneas de combustible. Con refuerzo termoplástico que le permite excelente flexibilidad y resistencia a los rayos UV. Color gris. Resistente al alcohol. Especialmente indicado para motores fueraborda. Garantía: 3 años

Marine fuel hose (distribution and vent) for outboards. Fuel resistant thermo-plastic formulation with 2 spiral reinforcement provides excellent bendability and resistance to UV, aging and permeation by all marine fuels (gasoline/petrol and diesel) including alcohol blends. Warranty: 3 years

Tubo «Trident» per linea combustibile. Con rinforzo termoplastico che gli permette un'eccellente flessibilità e resistenza ai raggi UV. Colore grigio. Resistente ai solventi. Indicato per i motori fuoribordo. Garanzia: 3 anni

Tuyau «Trident» pour carburant. Avec renfort thermoplastique qui permet une excellente flexibilité et résistance aux rayons UV. Gris. Résistant à l'alcohol. Convient particulièrement aux moteurs hors-bord. Garantie: 3 ans

REF				
TRI305-0566	5/16" = 7,92 mm	15 m	1	SAEJ1527
TRI305-0386	3/8" = 9,53 mm	15 m	1	ISO-8469 B1 CE



TRIDENT



De goma para diesel y gasolina sin plomo. Ideal para fueraborda. Refuerzos textiles internos. Muy flexible. Contenido aromático 50%

Rubber Hose suitable for loading mineral oils, diesel and unloaded fuel

In gomma per diesel e benzina senza piombo. Ideale per motori fuoribordo. Tessuto interno rinforzato. Molto flessibile.

Caoutchouc pour diesel et essence sans plomb. Idéal pour le hors-bord. Renforts textiles internes. Très flexible

### CARBUPOMP/10NL

REF						
GS35031	6x12	10 bar	50 mm	-25°C → 80°C	50 m	ISO R1307
GS35032	8x15	10 bar	65 mm		50 m	

H.T. - CARBUPOMP/10NL - WP 10 BAR - R-1M Q/m - ISO R1307

ht hoses technology

<b>MUELLE TUBO COMBUSTIBLE</b> REF PAF4-04000030 PAF4-05000010	<b>SPRING, FUEL PIPE</b> 	<b>MOLLA TUBO COMBUSTIBLE</b>	<b>RESSORT, TUYAU DE CARBURANT</b>	
-------------------------------------------------------------------------	---------------------------------------------------------------------------------------------------------------	-------------------------------	------------------------------------	-------------------------------------------------------------------------------------

<b>ABRAZADERA</b> REF REC650-24351-51 6 mm REC6E5-24351-51 8 mm	<b>CLAMP SMALL</b> 	<b>FASCETTE</b> REF REC09401-11425 6-8 mm 1 REC09401-11425BULK 6-8 mm 25	<b>COLLIER</b>	
--------------------------------------------------------------------------	---------------------------------------------------------------------------------------------------------	-----------------------------------------------------------------------------------	----------------	-------------------------------------------------------------------------------------

<b>ADPATADOR LÍNEA DE COMBUSTIBLE</b> REF REC22-8M0001721 Ø 11 mm --> Ø 9 mm	<b>COUPLER</b> 	<b>ADATTATORE</b>	<b>RACCORD COUPLEUR</b>
------------------------------------------------------------------------------------	-----------------------------------------------------------------------------------------------------	-------------------	-------------------------

<b>COMPONENTES TANQUE Y CONECTORES</b>	<b>FUEL TANK COMPONENTS &amp; CONNECTORS</b>	<b>COMPONENTI SERBATOIO E CONETTORI</b>	<b>COMPOSANTS ET CONNECTEURS DU RÉSERVOIR</b>
<b>CONECTOR DE DEPÓSITO</b>	<b>TANK CONNECTOR</b>	<b>ATTACCO SERBATOIO</b>	<b>RACCORDS DE RESERVOIR</b>

Fabricado en latón. REF GS31068 1/4" NPT 1	Made in machined brass. 	Fabricato in ottone.	Coude MF 1/4" NPT en laiton. 
--------------------------------------------------	----------------------------------------------------------------------------------------------------------------	----------------------	-----------------------------------------------------------------------------------------------------------------------

Para conectar dos motores a un sólo depósito, o viceversa. Fabricado en latón. REF GS31069 1/4" NPT 1	To connect two motors to a single tank, or vice versa. Made in machined brass. 	Per collegare due motori a un singolo serbatoio o viceversa. Fabricato in ottone.	Té en laiton, pour connecter deux moteurs à un même réservoir, ou inversement. 
----------------------------------------------------------------------------------------------------------------	--------------------------------------------------------------------------------------------------------------------------------------------------------------------------	--------------------------------------------------------------------------------------	-------------------------------------------------------------------------------------------------------------------------------------------------------------------------

REF REC17710-ZW9-033 BF4 --> BF130 HP	OEM 17710-ZW9-023 17710-ZW9-033		
---------------------------------------------	---------------------------------------	-------------------------------------------------------------------------------------	-------------------------------------------------------------------------------------

REF GS31030	OEM 17660-ZV5-902	3/8"	
antiguos   old   vecchio   ancien			

REF GS31031	OEM 17660-ZV5-A00 17660-ZW9-003	1/4" NPT 3/8"	
nuevos   news   nuovo   nouveau			

REF GS31034	OEM 17650-921-003ZB	3/8"	
antiguos   old   vecchio   ancien			

REF	OEM	
GS31033	116977-ZV5-A00	1/4" NPT

nuevos | news | nuovo | nouveau





REF	OEM	
GS31032	116977-ZV5-900	1/4" NPT

antigos | old | vecchio | ancien





PASAMAMPAROS	THRU HULL	PASSASCAFO	PASSE-CLOISON
Para atravesar mamparos de hasta 12 mm. Fabricado en latón.	For bulkhead up to 12 mm. Made in machined brass.	Per attraversare paratie fino a 12 mm. Fabricato in ottone.	Pour traverser des cloisons jusqu'à 12 mm. Fait en laiton.

REF		
GS31064	3/8"	1



FILTRO DE COMBUSTIBLE Y ELEMENTOS	FUEL FILTERS AND ELEMENTS	FILTRI BENZINA E RACCORDI	FILTRE A ESSENCE ET CARTOUCHE DE RECHANGE
BRACKET	BRACKET	SUPPORTO	TÊTE DE FILTRE À ESSENCE
Con 2 tapones de bronce y 2 tubos de extensión. (2 entradas y 2 salidas).	With 2 brass plugs and 2 extension tubes. (2 inputs & 2 outputs).	Con 2 tappi di bronzo e 2 tubi di estensione. (2 ingressi entrata carburante e 2 uscite carburante).	Avec 2 bouchons en bronze et 2 tubes d'extension. (2 entrées et 2 sorties).

REF		
REC25000	1/4"	AL
REC25010	1/4"	INOX /SS AISI316
REC25020	3/8"	AL
REC25030	3/8"	INOX /SS AISI316
RECOBBRACKET	1/4"	Plástico   Plastic Plastica   Plastique



REC25000 - REC25020      REC25010 - REC25030      RECOBBRACKET

FILTRO COMBUSTIBLE SEPARADOR DE AGUA	WATER SEPARATING FUEL FILTER	FILTRO SEPARATORE ACQUA-BENZINA	FILTRE SEPARATEUR EAU-ESSENCE	
REC24942	06177-ZX2-000HE	10	47/16"	11 cm
REC35-802893Q01		10	33/4"	
REC855686		28	47/16"	
REC35-802893Q		25	33/4"	
RACPF5510		10	47/16"	



RACPF5510      REC24942      REC35-802893Q01      REC855686      REC35-802893Q



Filtro original.	OEM filter.	Filtro benzina originale.	Filtre à essence d'origine
REC35-802893Q	10	33/4"	



FILTRO CON BRACKET	OEM FILTER WITH BRACKET	FILTRO BENZINA CON SUPPORTO	FILTRE A ESSENCE AVEC SUPPORT
Con 2 tapones de bronce y 1 tubo de extensión.	With 2 brass plugs & 1 extension tube.	Con 2 tappi di bronzo e 1 tubo di estensione.	avec 2 bouchons en bronze et 1 tube d'extension

REF	RO OEM	MICRON			BRACKET
REC24950		25	1/4"	50 GPH	AL
REC24952	06177-ZX2-000HE	10	1/4"	50 GPH	AL



FILTRO DECANTADOR DE COMBUSTIBLE COMPLETO CON VASO TRASPARENTE

COMPLET FUEL FILTER WITH TRANSPARENT BOWL

FILTRO DI DECANTAZIONE BENZINA COMPLETO CON VASCHETTA TRASPARENTE

FILTRE DÉCANTEUR ESSENCE AVEC BOL TRANSPARENT

REF		
RAC320R-RAC-01		AL
RAC320R-RAC-03	RACS3213 LENS3213	Plástico Plastic Plastica Plastique

RACOR



REF			
RECOBIFILALU			AL
RECOBFILTER	RECOBELEMENT LENS3213	150 l/h	Plástico Plastic Plastica Plastique

RECMAR



FILTRO CON BOMBA CEBADORA

FILTER WITH PRIMING PUMP

FILTRO CON PEMPETA PER RIEMPIRE

FILTRE A ESSENCE AVEC POMPE D'AMORCAGE

REF		MICRON			
RAC490R-RAC-01	RACS3227 LENS3227	10	340 l/h	3/8" NPTF	150 hp

RACOR



FILTRO DECANTADOR GASOLINA

COMPLETE FUEL FILTER

FILTRO DECANTATORE BENZINA

FILTRE DÉCANTEUR ESSENCE

Filtro de combustible con braket.

Complete fuel filter with braket.

Filtro combustibile con supporto.

Filtre à carburant avec support.

REF		MICRON
RAC23299-10	RAC23289-10	130 HP (4 T/ Strokes)

RACOR



REF	MICRON	
PAF40-0701000EI	10	70 hp



new



REF	OEM		R.O. / OEM	MICRON		
REC90794-46866		REC90794-46868		10	117 l/h	175 hp



LLAVE PARA FILTRO  
 FILTER KEY  
 CHIAVE DA FILTRO  
 CLÉ A FILTRE

REF
RECYS-225-15



## RACOR.



REF	RAC120R-RAC-01	RAC320R-RAC-01	RAC320R-INOX-01 RAC320R-RAC-03	RAC320R-RAC-02 RAC320R-INOX-02
RO /OEM	06178-ZW1-030GH		06177-ZW1-801AH	
FLUJO MÁXIMO MAX. FLOW FLUSSO MASSIMO FLUX MAXIMAL	114 l/h 30 gph	340 l/h 60 gph	340 l/h 60 gph	340 l/h 60 gph
ELEMENTO ELEMENT ELEMENTO ÉLÉMENT	RACS3240 LENS3240	RACS3213 LENS3213	RACS3213 LENS3213	RACS3220UL
CAZOLETA TRANSPARENTE (sólo se recomienda para fueraborda.) CLEAR BOWL (Just for outboards) VASCHETTA TRASPARENTE (Solo nei fuoribordo.) BOL TRANSPARENT (uniquement recommandé pour le hors-bord.)	17670-ZW1-030GH		17670-ZW1-801AH	
ROSCAS CENTRALES CENTRAL THREADS FILETTO CENTRALE TAILLE DU FILETAGE POUR LA CARTOUCHE	M18 x 1.5	1 1/4"	1 1/4"	1 1/4"
TAMAÑO ROSCA CABEZA HEAD PORT SIZE DIMENSIONE VITE TESTA TAILLE DU FILETAGE POUR LES RACCORDS	1/4-18 NPTF	1/4-18 NPTF	1/4-18 NPTF	1/4-18 NPTF
ALTURA X Ø HEIGHT X Ø ALTEZZA X Ø HAUTEUR X Ø	166 x 81 mm	238 x 102 mm	238 x 102 mm	238 x 102 mm
PESO WEIGHT PESO POIDS	0,5 kg	0,9 kg	0,9 kg	0,9 kg
CAIDA DE PRESIÓN PRESSURE DROP CADUTA DI PRESSIONE CHUTE DE PRESSION	0.15 PSI 0.01 bar	0.61 PSI 0.04 bar	0.61 PSI 0.04 bar	0.61 PSI 0.04 bar
PRESIÓN MÁXIMA MAX. PRESSURE PRESSIONE MASSIMA PRESSION MAXIMALE	7 PSI 0.05 bar	7 PSI 0.05 bar	7 PSI 0.05 bar	7 PSI 0.05 bar
DESMONTAJE CARTUCHO-CAZOLETA ELEMENT REMOVAL UNDERBOWL RIMOZIONE DELLA CARTUCCIA DEMONTAGE DE LA CARTOUCHE	25,4 mm 1"	25,4 mm 1"	25,4 mm 1"	25,4 mm 1"
TEMPERATURA DE TRABAJO OPERATING TEMPERATURE TEMPERATURA DI LAVORO TEMPERATURE DE TRAVAIL	-40°C + 124°C			

RÁCORES		RACORS		RACCORDI			RACCORDS				
REF											
GS31065	1/4" NPT	3/8" = 9.5 mm	1	GS31066	1/4" NPT	5/16" = 7.9 mm	2	GS31067	1/4" NPT	3/8" = 9.5 mm	2
GS31166	1/4" NPT	5/16" = 7.9 mm	2								
GS31155	3/8" NPT	3/8" = 9.5 mm	2								
GS31156	3/8" NPT	5/16" = 7.9 mm	2								
GS31157	3/8" NPT	1/4" = 6.4 mm	2								

LLAVES PARA FILTRO		FILTER KEY		CHIAVE DA FILTRO		CLÉ À FILTRE	
REF				REF			
RACRK22628				REC70720	65 - 110 mm		

FILTRO COMBUSTIBLE PARA MONTAJE EN LÍNEA		IN-LINE FUEL FILTER		
REF				
GS31001	50 l/h	6-8 mm	plástico plastic plastica	1
GS31002	150 l/h	8-10 mm	plástica plastique	1

GS31001 GS31002

**GOLDENSHIP**

FILTRO BENZINA PER MONTARE IN LINEA		FILTRE A ESSENCE EN LIGNE	
REF	OEM		
REC16910-ZV4-015	16910-ZV4-015		
BF15AM/B/D3/DK2	BF90DK0/DK2/DK4		
BF8C/CX/B1/B2/D1/D2/	BF100A		
P8B1/P8B2/DK2	BF60A/AK1		
BF9.9AH/AK/AM/B/DK2/D1	BF80A		
BF25D4/DK2/A/A1/AX			
BF30D4/DK2/A/A1/AX			
BF20A/AX/D3			
BF10B1/D1/P10B1/DH/DK2			
BF75DK0/DK2/DK3			
BF40D/DK2			
BF50D/DK2			

FILTRO COMBUSTIBLE PARA MONTAJE EN LÍNEA		IN-LINE FUEL FILTER		
REF				
GS30435	6, 8, 10 mm	metal + cristal metal + crystal metal + cristal métal + verre	1	

**GOLDENSHIP**

FILTRO COMBUSTIBLE PARA MONTAJE EN LÍNEA		IN-LINE FUEL FILTER		
REF	OEM			
REC16900-SA5-004	16900-SA5-004			
BF35AM				
BF40B/B2/BX/A4/A1/A2/AX/A3/AY				
BF45AM				
BF75A1/AT/AV/AX/A2/A3				
BF90A1/AF/AV/AX/A2/A3				
BF50A4/A1/A2/AX/A3/AY				
(14ZW00E1M)				

FILTRO COMBUSTIBLE PARA MONTAJE EN LÍNEA		IN-LINE FUEL FILTER		
REF	OEM			
REC40145		1/4"	1/4"	plástico
REC40155		5/16"	5/16"	plastic
REC40165		3/8"	3/8"	plastica
REC40135		5/16"	3/8"	plastique

FILTRO COMBUSTIBLE PARA MONTAJE EN LÍNEA		IN-LINE FUEL FILTER		
REF	OEM			
REC16910-GB2-005	16900-GB2-005			
BF4.5B/BX/B2/B4/B6				
BF5A1/AH/AK/AM/AX/A2/A3/A4				
BF6B/BX/D6				
BF8AX/BX/AH/AK/AM				
BF50F				
BF75F				

FILTRO COMBUSTIBLE PARA MONTAJE EN LÍNEA		IN-LINE FUEL FILTER		
REF	OEM			
REC16900-SR3-004	16900-SR3-004			
BF115A1 / A2 / A3 / AX				
BF130A1 / A2 / A3 / AX				
Series #14ZW50E1M				

REF	OEM
REC16901-ZY3-003	16901-ZY3-003 16911-ZY3-003

 BF115  
 BF135  
 BF150  
 BF175  
 BF200  
 BF225  
 BF250



REF	OEM
REC16911-ZZ5-003	16911-ZZ5-003

 BF40D, DK2, DK4, E  
 DF50D, DK2, DK4  
 BF60A, AK1  
 BFF60A, AK1



REF	OEM
REC16911-ZY3-010	16911-ZY3-010

 BF80A  
 BF100A  
 BF90D2 / D4 / DK0  
 BF75DK2 / DK3 / DK0  
 BF150AK2 / A4  
 BF135AK2 / A4  
 BF225AK2 / AK3 / AK1 / A6  
 BF200AK2 / AK3 / AK1 / A6  
 BF175AK2 / AK3 / AK1 / A6  
 BF250A  
 BF115D / DK1 / A2  
 BF130 A2



REF	OEM
REC16010-ST5-993	16900-ST5-993

 BF115  
 BF130 / AX / AY / A1  
 Series #14ZW50E1M



REF	OEM		
RAC025-RAC-02	06176-ZW3-801AH	1/4" 18 NPTF	1/4" 18 NPTF

 BF5  
 BF20



REF	OEM
RACS2502	17670-ZW3-801AH



ACEITE OIL OLIO HUILES

REF			
REC2TU6	1 L	6	2 STROKES
REC2TU3	5 L	3	TC-W3
REC5W40U6	1 L	6	SAE 5W40
REC5W40U3	5 L	3	
REC10W30U6	1 L	6	SAE 10W30
REC10W30U3	5 L	3	
REC10W40U6	1 L	6	SAE 10W40
REC10W40U3	5 L	3	
REC25W40U3	5 L	3	SAE 25W40
REC80W90U3	5 L	3	
REC80W90U6	1 L	6	SAE 80W90



REF			
RM92-858026QB1U6	1 L	6	2 STROKES
RM92-858027QB1U3	3,8 L	3	
RM92-8M0086220U6	1 L	6	SAE 10W30
RM92-8M0086221U3	4 L	3	



RM92-858026QB1U6    RM92-858027QB1U3    RM92-8M0086220U6    RM92-8M0086221U3

FILTRO DE ACEITE

OIL FILTER

FILTRO OLIO

FILTRE A HUILE

FILTROS DE ACEITE

OIL FILTER

FILTRO OLIO

FILTRES A HUILE

REF	OEM
REC35-822626Q03	15400-PM3-004
	15400-PFB-014,
	15400-PFRB-007
	15400-ZW4-003
	15400-PJ7-015
	15400-PM3-405
	15400-PFB-004



 BF25DE4	BF15DK3	BF50DK2
 BF30D4	BF20D3	BF50DK4
 BF8B2	BF20DK2	BF8D4
 BF8D2	BF20DK3	BFP10D2
 BF10B2	BF25DK2	
 BF10D2	BF30DK2	
 BF10D4	BF40DK2	
 BF15D3	BF40DK4	

REF	OEM
REC15400-PLM-A01PE	15400-PH1-F03
	15400-POH-305PE
	15400-POH-305
	15400-ZJI-004
	15400-PLM-A01PE
	15400-RTA-003
	15400-RTA-004



 BF100A	BF150AK2	BF200AK2	BF250A	BF90DK0
 BF100AK1	BF175A6	BF200AK3	BF250D	BF90DK2
 BF115A2	BF175AK1	BF200D	BF75DK0	BF90DK4
 BF115D	BF175AK2	BF225A6	BF75DK2	BF90DK5
 BF115DK1	BF175AK3	BF225AK1	BF75DK3	BFT100AK1
 BF135A4	BF175D	BF225AK2	BF75DK4	BFT80AK1
 BF135AK2	BF200A6	BF225AK3	BF80A	
 BF150A4	BF200AK1	BF225D	BF80AK1	

REF	OEM
REC15400-RBA-F01	15400-RBA-F01



 V-TEC150	
 V-TEC175	

REF	OEM
REC5GH-13440-00	15400-PFB-007



 BF25	
 BF30	
 BF40	

GUÍA FILTROS DE ACEITE

OIL FILTER GUIDE

GUIDA FILTRO OLIO

GUIDE DES FILTRES A HUILE

	REF
 BF8B2	
 BF8D2	REC35-822626Q03
 BF8D4	
 BF10B2	
 BF10D2	REC35-822626Q03
 BF10D4	
 BFP10D2	
 BF15D3	REC35-822626Q03
 BF15DK3	
 BF20D3	
 BF20DK2	REC35-822626Q03
 BF20DK3	
 BF25	REC5GH-13440-00
 BF25DE4	REC35-822626Q03
 BF25DK2	
 BF30	REC5GH-13440-00
 BF30D4	
 BF30DK2	REC35-822626Q03
 BF40	REC5GH-13440-00
 BF40DK2	
 BF40DK4	REC35-822626Q03

	REF
 BF50DK2	
 BF50DK4	REC35-822626Q03
 BF75DK2	
 BF75DK3	M20 x 1.5
 BF75DK4	REC15400-PLM-A01PE
 BF75DK0	
 BF80A	
 BF80AK1	M20 x 1.5
 BFT80AK1	REC15400-PLM-A01PE
 BF90DK2	
 BF90DK4	M20 x 1.5
 BF90DK5	REC15400-PLM-A01PE
 BF90DK0	
 BF100A	
 BF100AK1	M20 x 1.5
 BFT100AK1	REC15400-PLM-A01PE
 BF115A2	
 BF115D	M20 x 1.5
 BF115DK1	REC15400-PLM-A01PE
 BF135A4	
 BF135AK2	M20 x 1.5
	REC15400-PLM-A01PE

	REF
 BF150A4	M20 x 1.5
 BF150AK2	REC15400-PLM-A01PE
 BF175A6	
 BF175AK1	M20 x 1.5
 BF175AK2	REC15400-PLM-A01PE
 BF175AK3	
 BF175D	
 BF200A6	
 BF200AK1	M20 x 1.5
 BF200AK2	REC15400-PLM-A01PE
 BF200AK3	
 BF200D	
 BF225A6	
 BF225AK1	M20 x 1.5
 BF225AK2	REC15400-PLM-A01PE
 BF225AK3	
 BF225D	
 BF250A	M20 x 1.5
 BF250D	REC15400-PLM-A01PE
 V-TEC150	M20 x 1.5
 V-TEC175	REC15400-RBA-F01

**BOMBA DE COMBUSTIBLE ELECTRICA**

**ELECTRIC FUEL PUMP**

**POMPA BENZINA ELETTRICA**

**POMPE À ESSENCE ÉLECTRIQUE**

REF	OEM
REC16735-ZW5-003	16735-ZW5-003 16735-ZY3-004

- BF100A, AK1
- BTF100AK1
- BF115A1, A2, A3, AX
- BF130A1, A2, AX
- BF135A4, AK2
- BF150A4, AK2
- BF75DK0, DK2, DK3, DK4
- BF90DK0, DK2, DK4, DK5

- BF80A, AK1
- BFT80AK1
- BF175D, A3, A6, AK1, AK2, AK3
- BF200D, A2, A3, A6, AK1, AK2, AK3
- DF225D, A2, A3, A6, AK1, AK2, AK3
- BF250D, A

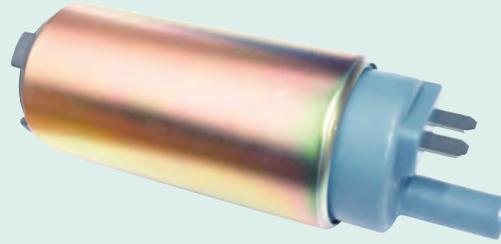

new

**INYECTORES**

**INJEKTOR**

**INIETTORE**

**INJECTEURS**

**INJECTOR**

**INJEKTOR**

**INIETTORE**

**INJECTEURS**

REF	OEM
REC06164-PCA-000	16450-ZY6-003

- BF115AX
- BF130AX



new

**CARBURADOR**

**CARBURETOR**

**CARBURATORE**

**CARBURATEUR**

**AGUJA CARBURADOR**

**CARBURETOR, NEEDLE VALVE**

**SPILLO CONICO CARBURATORE**

**POINTEAU CARBURATEUR**

REF	OEM
REC16011-881-741	16011-881-741

- BF5 (-2003)
- BF8
- BF75 (-1997)
- BF100 (-1997)



REF	OEM
REC16011-ZV4-005	16011-ZV4-005

- BF8 (2001+)
- BF9.9
- BF15
- BF20 (2003+)
- BF25
- BF30
- BF35 (1997)
- BF40
- BF45 (1997)
- BF50
- BF75 (1997+)
- BF90 (1997+)



HONDA

RECAMBIOS MARINOS

KITS CARBURADORES

CARBURETOR KITS

KIT CARBURATORI

KIT CARBURATEUR

REF	OEM
REC06160-ZV4-U11	06160-ZV4-U11 Honda KIT 1
 BF9.9 (2000+) BF15 (2002+)	

REF	OEM
REC16010-ZW9-003	16010-ZW9-003 Honda KIT2
 BF9.9 (2001+) BF15 (2003+)	

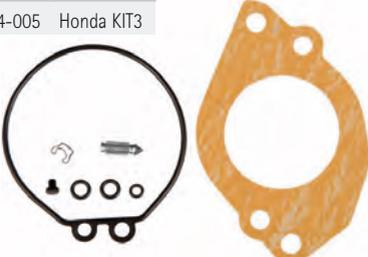
REF	OEM
REC16010-ZV4-005	16010-ZV4-005 Honda KIT3
 BF75 (1997+) BF90 (1997+)	

REF	OEM
REC18-7053	Honda KIT4
 BF8 (1996+) BF75 (1996+) BF100 (1996+)	

GUÍA CARBURADORES

GUIDE CARBURETORS

GUIDA CARBURATORI

GUIDE DES CARBURATEURS

	KIT
BF8C, CX	REC16010-ZV4-005
BF8B1, B2, D1, D2, D3, D4, DK2	REC16010-ZW9-003
BF8 (2001+)	REC18-7053
BFP8B1, B2, D1, D2, D3	REC16010-ZW9-003
BF9.9	REC18-7053
BF9.9AH, AK, AM, AX, AY, B, BX	REC16010-ZV4-005
BF9.9D1, D2, D3, DK2	REC16010-ZW9-003
BFP9.9D, D1, D2	REC16010-ZW9-003
BF10B1, B2, D1, D2, D4, K2	REC16010-ZW9-003
BFP10B1, B2, D1, D2	REC16010-ZW9-003
BF15	REC18-7053
BF15A1, A2, A3	REC06160-ZV4-U11 REC16010-ZV4-005
BF15AH, AM, AX, AY	REC16010-ZV4-005
BF15B, B2, BX	REC16010-ZV4-005
BF15D3, DK2, DK3	REC16010-ZW9-003
BF20 (2003+)	REC18-7053
BF20A, A2, AX	REC16010-ZV4-005

	KIT
BF20D3, DK2, DK3	REC16010-ZW9-003
BF25	REC18-7053
BF25A, A1, A2, A3, AX, D4, DK2	REC16010-ZV4-005
BF30	REC18-7053
BF30A, A1, A2, A3, AX, D4, DK2	REC16010-ZV4-005
BF35 (1997)	REC18-7053
BF35AM	REC16010-ZV4-005
BF40	REC18-7053
BF40A, A1, A2, A3, A4, AX, AY, B, B2, BX	REC16010-ZV4-005
BF45 (1997)	REC18-7053
BF45AM	REC16010-ZV4-005
BF50	REC18-7053
BF50A, A1, A2, A3, A4, AX, AY	REC16010-ZV4-005
BF75 (1997+)	REC18-7053
BF75A1, A2, A3, AT, AV, AX	REC16010-ZV4-005
BF90 (1997+)	REC18-7053
BF90A1, A2, A3, AT, AV, AX	REC16010-ZV4-005



# SISTEMA ELÉCTRICO ELECTRIC SYSTEM

# SISTEMA ELETTRICO SYSTEME ELECTRIQUE

## SENSORES      SENSORS      SENSORE      CAPTEURS

### SENSOR MAP      MAP SENSOR      SENSORE MAP      CAPTEUR MAP

REF	OEM
REC37830-PGK-A01	37830-PGK-A01
 BF135A4	
 BF150A4	
 BF175A3, A6	
 BF200A2, A3, A6	
 BF225A2, A3, A6	



*new*

REF	OEM
REC37830-PNC-003	37830-PNC-003
 BF40DK2, D	
 BF50DK2,D	
 BF75, DK0, DK2	
 BF90DK0, DK2	



*new*

REF	OEM
REC37830-RNA-A01	37830-RNA-A01
 BF100A, AK1	BF135A4, AK2
 BFT100AK1	BF50D
 BF40E	BF150A4, AK2
 BF80A, AK1	BF175D, AK1, AK2, AK3
 BF75DK3, DK4	BF200D, AK1, AK2, AK3
 BF90DK4, DK5	BF250D, A
 BF60A	
 BF115D, DK1	
 BF40D	



*new*

### SENSOR POSICIÓN ARBOL DE LEVAS      CAMSHAFT SENSOR      SENSORE ALBERO A CAME      CAPTEUR DE POSITION D'ARBRE A CAMES

REF	OEM
REC37510-PNB-003	37510-PNB-003
 BF115D, DK1	
 BF135A4, AK2	
 BF150A4, AK2	



*new*

REF	OEM
REC37500-PNB-003	37500-PNB-003
 BF175D	
 BF200D	
 BF225D	
 BF250D	
 BF115D, DK1	
 BF135A4, AK2	
 BF150A4, AK2	
 BF75DK0, DK2	
 BF90DK0, DK2, DK5	
 BF75DK3, DK4	
 BF100A, AK1	
 BF80A, AK1	
 BF60A	
 BF40E	



*new*

### SENSOR POSICIÓN CIGUENAL      CRANKSHAFT SENSOR      SENSORE ALBERO MOTORE      CAPTEUR DE POSITION DU VILEBREQUIN

REF	OEM
REC37840-R70-A01	37840-R70-A01
 BF175D	
 BF200D	
 BF225D	
 BF250D	



*new*

HONDA

RECAMBIOS MARINOS

**SENSOR DETONACIÓN**

**KNOCK SENSOR**

**SENSORE ANTIDETONAZIONE**

**CAPTEUR DE CLIQUETIS**

REF	OEM
REC30530-P8F-A01	30530-P8F-A01

- BF175A3, A6
- BF200A2, A3, A6
- BF225A2, A3, A6



new

REF	OEM
REC30530-PNA-003	30530-PNA-003

- BF135A4
- BF150A4



new

REF	OEM
REC30530-RNA-A01	30530-RNA-A01

- BF175AK1, AK2, AK3
- BF200AK1, AK2, AK3
- BF225AK1, AK2, AK3
- BF250A



new

**SENSOR MAT TEMPERATURA DEL AIRE**

**SENSOR MAT, AIR TEMPERATURE**

**SENSORE MAT, TEMPERATURA ARIA**

**CAPTEUR MAT DE TEMPERATURE D'AIR**

REF	OEM
REC37880-PLC-004	37880-PLC-004

- BF115D, DK1
- BF135A4, AK2
- BF150A4, AK2
- BF75DK0, DK2, DK3, DK4
- BF90DK2
- BF80A, AK1
- BFT80AK1
- BF60A, AK1
- BFP60A,
- BF40D, E
- BF50D,
- BF40DK2
- BF50DK2



new

**SENSOR OXÍGENO**

**O2 SENSOR**

**SENSORE OSSIGENO**

**CAPTEUR À OXYGENE**

REF	OEM
REC35668-ZY6-003	35668-ZY6-003

- BF115D, DK1
- BF135A4, AK2
- BF150A4, AK2,



REF	OEM
REC35655-ZY3-013	35655-ZY3-013

- BF175A3, A6,
- BF200A2, A3, A6
- BF225A2, A3, A6,



REF	OEM
REC35655-ZY9-003	35655-ZY9-003

- BF75DK0, DK2
- BF90DK0, DK2
- BF75DK0, DK2
- BF90DK0, DK2



REF	OEM
REC35655-ZY3-C01	35655-ZY3-C01

- BF250A,
- BF175AK1, AK2, AK3
- BF200AK1, AK2, AK3
- BF225AK1, AK2, AK3,
- BF40D, DK2, DK4
- BF50D, DK2, DK4,



new

**SENSOR PRESIÓN DE ACEITE**

**OIL PRESSURE SENSOR**

**SENSORE PRESIONE DELL'OLIO**

**CAPTEUR DE PRESSION D'HUILE**

REF	OEM
REC37260-RNA-A01	37260-RNA-A01

- BF175D
- BF200D
- BF225D
- BF250D
- BF115D, DK1,
- BF135A4, AK2
- BF150AK2
- BF75DK3, DK4
- BF90DK4, DK5
- BF100A, AK1
- BF80A, AK1
- BFT100AK1

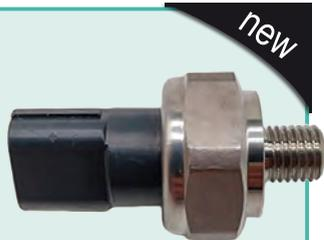

new



## BOBINAS

## COILS

## BOBINE

## BOBINES

REF	OEM
REC30520-PWC-003	30520-PWC-S01



 BF75DK0, DK2, DK3  
 BF90DK0, DK2, DK4  
 BF100A  
 BF80A

REF	OEM
REC30520-PNA-007	30520-PNA-007



 VTEC  
 BF135A4  
 BF150A4  
 BF115D, DK1  
 BF135A4, BF150A4,  
 BF135AK2, BF150AK2

REF	OEM
REC30580-ZV4-013	30580-ZV4-023



 BF15AH, AK, AM, B, A1, A2, AX, AY, B2, BX, A3  
 BF9.9AH, AK, AM, B, AX, AY  
 BF8C, CX



REF CHAPROSU



 P 49  
 REF RECO04

## BUJÍAS

## SPARK

## CANDELE

## BOUGIES

		REF NGK
BF2D	1999	NGKCR5HSB
BF2/A	1984	NGKBMR4A
BF2B		NGKCR5HSB
BF2.3		NGKCR5HSB
BF4.5B		NGKBPR5ES
BF5AK		NGKBPR5ES
BF5	1984	NGKBPR5ES
BF5A		NGKBPR5ES
BF6B	2003	NGKDR4HS
BF6		NGKDR4HS
BF6CH	2004	NGKCR5EH-9
BF7,5	1977	NGKDR5HS
BF8	2001	NGKCR5EH-9
BF8D		NGKCR5EH-9
BF8D1	2001	NGKCR5EH-9
BF8	1987-00	NGKDR5HS
BF8 A/B/C	1990-00	NGKDR5HS
BF8B1		NGKCR5EH-9
BF9/A		NGKDR5HS
BF9.9	1987-01	NGKDR5HS
BF9.9 A/B		NGKDR5HS
BF9.9D1	2001	NGKCR5EH-9
BF10D	2001	NGKCR5EH-9
BF10/B1	2001	NGKCR5EH-9
BF15D	2003	NGKCR5EH-9
BF15B		NGKDR5HS
BF15	1987-90	NGKDR6HS
BF15A	1996-02	NGKDR5HS
BF20	1993	NGKDR7EA
BF20/F	1985	NGKBMR4A
BF20D	2003	NGKCR5EH-9
BF25/A	1993	NGKDR7EA
BF25B		NGKDR7EA

		REF NGK
BF25D4	2004	NGKDR7EA
BF28		NGKCR5HSB
BF28D		NGKCR5HSB
BF30/A	1994	NGKDR7EA
BF30D4	2004	NGKDR7EA
BF35/A	1990	NGKDR7EA
BF40B		NGKDR7EA
BF40/A	1994	NGKDR7EA
BF45/A	1990	NGKDR7EA
BF50/F	1985-94	NGKBPR5ES
BF50	1986-94	NGKBPR5ES
BF50/A	1994	NGKDR7EA
BF60A		NGKLMAR6C-9
BF70A		NGKDR7EA
BF75	2003	NGKDR7EA
BF75B		NGKDR7EA
BF75D		NGKIZFR6K-11E
BF75E		NGKDR5HS
BF75A	1995	NGKDR7EA
BF75		NGKDR5HS
BF90/A	1995	NGKDR7EA
BF90D		NGKIZFR6K-11E
BF100E		NGKDR5HS
BF100		NGKDR5HS
BF115/A	1998	NGKZFR7F
BF130A	1998	NGKZFR7F
BF135A		NGKIZFR6K11
BF150A		NGKIZFR6K11
BF175A		NGKIZFR6K11
BF200A V6	2002	NGKIZFR6K11
BF225A V6	2002	NGKIZFR6K11
BF250A	2010	NGKIZFR6K11



		REF CHAMPION
2HP	BF2A,D	CHACJ14
5HP	OHC - BF5A	CHARN11YC4
7.5HP	B75	CHAP10Y
8.0HP	OHC - BF8A	CHAP10Y
9.9HP	BF9.9A	CHAP10Y
15HP	OHC - BF15A	CHAP8Y
20HP	BF20A	CHARA6HC
25HP	OHC - BF25A	CHARA8HC
30HP	OHC - BF30A	CHARA8HC
35HP	BF35A	CHARA8HC
40HP	OHC - BF40A	CHARA8HC
45HP	BF45A	CHARA8HC
50HP	OHC - BF50A	CHARA8HC
70HP	OHC - BF70A	CHARA8HC
75HP	BF75A	CHARA8HC
90HP	OHC - BF90A	CHARA8HC
115HP	OHC	CHARC9MC4
130HP	OHC	CHARC9MC4
150HP	BF150, BF200, 225	CHARC9MC4



MOTORES DE ARRANQUE

STARTERS

MOTORINI AVVIAMENTO

DEMARREURS

MOTORES DE ARRANQUE

STARTERS

MOTORINI AVVIAMENTO

DEMARREURS

REF	OEM	⚡	☀️
REC31200-ZW9-802	31200-ZW9-802 31200-ZW9-801	12V	11 CCW

 BF8B2, D2, D3, D4  
 BFP8B2, D2, D3, DK2  
 BF9,9DK2, D3  
 BF10D4, DK2, 0B2,  
 BFP10B2, D2,  
 BFP9,9D3,



REF	OEM	⚡	☀️
REC31200-ZY6-003	31200-ZY6-003 31200-ZY9-003 31200-ZY9A-0031	12V 1.00 KW	9 CW

 BF115D, DK1  
 BF135A4, AK2  
 BF150A4, AK2  
 BF75DK0, DK2  
 BF90DK2, DK0



REF	OEM	⚡	☀️
PH130-0064	31200-ZW1-004	12V 1.4 KW	13 CW

 BF75A1, A2, A3, AT, AV, AX,  
 BF90A1, A2, A3, AT, 90AV, AX



REF	OEM	⚡	☀️
PH130-0065	31200-ZW5-003	12V 1.4 KW	13 CW

 BF115A1, A2, A3, AX,  
 BF130A1, A2, A3, AX,



REF	OEM	⚡	☀️
PH130-0054	31200-ZV5-013 31200-ZV5-003	12V 0.9 KW	9 CW

 BF35AM,  
 BF40B, BX, AX, A1, A2, A3, A4, AY,  
 BF45AM, A, A1,  
 BF50A, A1, A2, A3, A4, AX, AY,



REF	OEM	⚡	☀️
PH130-0070	31200-ZY3-003 31200-ZY3A-0034	12V 1.7 KW	9 CW

 BF175D, A3, A6, AK1, AK2, AK3  
 BF200D, A2, A3, A6, AK1, AK2, AK3  
 BF225D, A2, A3, A6  
 BF250D, A, AK1, AK2, AK3



GUÍA DE ARRANQUE

STARTER GUIDE

GUIDE AVVIAMENTO

GUIDE DE DÉMARREURS

				
BF8	2001		REC31200-ZW9-802	
BF10	2001		REC31200-ZW9-802	
BF9,9	2001		REC31200-ZW9-802	
BF35	1995-1997		PH130-0054	
BF40	1995		PH130-0054	
BF45	1995-1997		PH130-0054	
BF50	1995		PH130-0054	
BF75	2007		REC31200-ZY6-003	
BF75	1997-2006		PH130-0064	
BF90	1997-2006		PH130-0064	

				
BF90	2007		REC31200-ZY6-003	
BF115	1999-2006		PH130-0065	REC31630-ZW5-003
BF115	2007		REC31200-ZY6-003	REC31630-ZY6-003
BF130	1999-04		PH130-0065	REC31630-ZW5-003
BF135	2004		REC31200-ZY6-003	REC31630-ZY6-003
BF150	2004		REC31200-ZY6-003	REC31630-ZY6-003
BF175	2002		PH130-0070	REC31630-ZY3-003
BF200	2002		PH130-0070	REC31630-ZY3-003
BF225	2002		PH130-0070	REC31630-ZY3-003
BF250	2012		PH130-0070	REC31630-ZY3-003

## DESCONECTORES DE SEGURIDAD

## CUT OFF SWITCHES

## CHIAVETTA DI SICUREZZA

## COUPE CIRCUIT DE SECURITE

### DESCONECTADOR DE SEGURIDAD

Interruptor de encendido para motores. Aísla los circuitos en unidades dobles para prevenir el retorno al alternador.

### IGNITION KILL SWITCHES

Emergency and stop switch. Isolates circuits on dual units to prevent feedback.

### INTERRUTTORE DI STOP

Interruttore di accensione per motori. Isola i circuiti in doppie unità per prevenire il ritorno all'alternatore.

### COUPE CIRCUIT DE SECURITE

Interrupteur d'arrêt d'urgence. Il isole les circuits en double pour éviter le retour à l'alternateur.

REF

THKS-1	Un fueraborda	Single outboard	Un fuoribordo	Un hors-bord	1
THKS-2	Un intraborda	Single I/O	Un entrobordeo	Un inboard	1
THKS-12	Dos fuerabordos	Dual outboard	Due fuoribordo	Deux hors-bord	1
THKS-22	Dos intrabordos	Dual I/O	Due entrobordeo	Deux inboard	1
THL-4	Cuerda recambio	Spare lanyard	Corde ricambio	Cordon de rechange	1



### KITS

Interruptor de encendido para todo tipo de motores fueraborda o intraborda

### KITS

Emergency and stop switch for inboard or outboards.

### KIT

Interruttore di accensione per tutti i tipi di motori fuoribordo o entrobordeo.

### KITS

Coupe circuit de sécurité pour moteur inboard ou hors-bord

REF KIT	CUERDA WIRE CORDA CORDON	
REC40970	REC40990	1



REF KIT	CUERDA WIRE CORDA CORDON	
GS11290	GS11291	1



REF KIT	
GS11292	1



REF	
GS11294	1



## ALTERNADOR

## ALTERNATOR

## ALTERNATORE

## ALTERNATEUR

### ALTERNADOR

### ALTERNATOR

### ALTERNATORE

### ALTERNATEUR

REF	OEM	12V 55A	new
REC31630-ZY6-003	31630-ZY6-003 31630-ZY6-013	REC31638-ZY6-003 4	

BF115D, DK1,  
BF135A4, AK2  
BF150A4, AK2



REF	OEM	6
REC31630-ZY3-003	31630-ZY3-003	REC31638-ZY3-003 6

BF250A,  
BF175A3, A6, AK1, AK2, AK3, D  
BF200A2, A3, A6, AK1, AK2, AK3, D  
BF225A2, A3, A6, AK1, AK2, AK3, D  
BF250D, A,



REF	OEM	12V 55A CW	new
REC31630-ZW5-003	31630-ZW5-003	4	

BF115A1, A2, A3, AX  
BF130A1, A2, A3, A4, AX



**CORREAS DE ALTERNADOR**

**ALTERNATOR BELT**

**CURROIA ALTERNATORE**

**COURROIE D'ALTERNATEUR**

**new**

REF	OEM
REC31638-ZY3-003	31638-ZY3-003

 BF175A3, A6, AK1, AK2, AK3, D, BF200A2, A3, A6, AK1, AK2, AK3, D, BF225A2, A3, A6, AK1, AK2, AK3, D, BF250D



**new**

REF	OEM
REC31638-ZY6-003	31638-ZY6-003

 F115D, BF115D, DK1, BF135A4, AK2, BF150A4, AK2



**TRIM, TILT & POWER TRIM**

**INSTALACIÓN ELÉCTRICA**

**WIRING HARNESS**

**INSTALLAZIONE ELETTRICA**

**INSTALLATION ELECTRIQUE**

**KIT CONVERSIÓN**  
Sustituye de 2 a 3 cables.

**CONVERSION KIT**  
Converts 3-wire Tilt and Trim motors to 2-Wire design

**KIT CONVERSIONE**  
Sustituisce da 2 a 3 cavi.

**KIT DE CONVERSION.**  
Passe un faisceau de 2 à 3 fils

REF
PH200-WH01



**TRIM COMPLETO**

**COMPLETE TRIM ASSEMBLY**

**MOTORINO TRIM COMPLETO**

**MOTEUR DE TRIM**

**new**

REF	OEM	⚡	🔩	✂️
PH200-T046	36120-ZV5-822	12V	4	2

 BF40, BF50 (2002-03)



REF	OEM	⚡	🔩	✂️
PH200-T021	36120-ZV5-821	12V	4	2

 BF35AM, BF40B, B2, BX, A, A1, A2, AX, AY, BF45AM, BF50A, A1, A2, AX, AY



REF	OEM	⚡	🔩	✂️
REC36120-ZY3-013	36120-ZY3-013	12V	4	

 BF175A3, A6, AK1, AK2, BF200A2, A3, A6, AK2, BF225A2, A3, A6, AK1, AK2,



REF	OEM	⚡	🔩	✂️
REC36120-ZW4-H12	36120-ZW4-H12	12V	4	

 BF40A4, BF50A4, BF40D, DK2, DK4, BF50D, DK2, DK4



REF	OEM	⚡	🔩	✂️
REC36120-ZY6-013	36120-ZY6-013 36120-ZY6-023	12V	4	

 BF115D, DK1  
 BF135A4, AK2  
 BF150A4, AK2



REF	OEM	⚡	🔩	✂️
REC36120-ZY9-003	36120-ZY9-003 36120-ZY9-013	12V	4	

 BF75DK0, DK2, DK3  
 BF90DK0, DK2, DK4  
 BF100A  
 BF80A



**POWER TRIM COMPLETO**    **COMPLETE POWER TRIM ASSEMBLY**    **MOTORINO POWER TRIM COMPLETO**    **POWER TRIM COMPLET**

REF
REC18-6865

 3 RAM  
 115-225HP  
 BF115+

SHOWA SYSTEM



**EXTRACTOR TAPONES TRIM**    **TRIM PLUGS EXTRACTOR**    **ESTRATTORE PER TAPPI DI TRIM**    **KIT EXTRACTEUR DE BOUCHONS TRIM** new

REF	RECTOOLTRIMKIT	TRIM PISTON	TILT PISTON	🔩
	RECTOOLTRIM1 + RECTOOLTRIM2 + RECTOOLTRIM3	RECTOOLTRIM2	RECTOOLTRIM3	75 --> 225 (1997+)

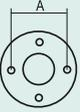

REF	🔩				A	📏
RECTOOLTRIM1	1/2"	+ RECPIN4	+ RECPIN4.5	38 mm		
RECTOOLTRIM2	1/2"	+ RECPIN4	+ RECPIN4.5	32 mm		
RECTOOLTRIM3	1/2"	+ RECPIN6		35 mm		

Los pines de repuesto no tienen garantía.  
 Replacement pins are not guaranteed.  
 I perni di ricambio non sono garantiti.  
 Les pins de remplacement ne sont pas garanties

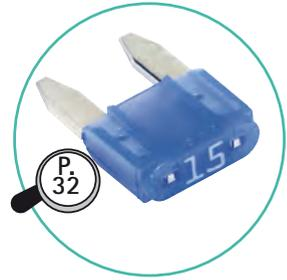

# SISTEMA DE GOBIERNO STEERING SYSTEM

# SISTEMA DI GUIDA SYSTÈME DE COMMANDE

## MANDOS DE CONTROL

## ENGINE CONTROLS

## COMANDI DI CONTROLLO

## BOITIER DE COMMANDE

### MANDO LATERAL

### SIDE CONTROL

### COMANDO LATERALE

### BOITIER LATERAL

REF	OEM	POWER TRIM
REC24800-ZZ5-A02	24800-ZZ5-A02 24800-ZZ5-A01 24800-ZZ5-A22	✓

**RECMAR**<sup>®</sup>

(NHK MEC) BF40 --> BF250  
EFI  
4 LED



### MANDO PARA CONSOLA

### CONSOLE CONTROL

### COMANDO PER CONSOLLA

### BOITIER POUR CONSOLE

REF	RO OEM	TRIM TILT
REC06240-ZW5-U40	06240-ZW5-U40 06240-ZW5-U001	✓

REF	RO OEM	TRIM TILT
REC06240-ZW5-U60	06240-ZW5-U60	✓

BF40 --> BF250

**RECMAR**<sup>®</sup>



# LLAVES ARRANQUE IGNITION STARTER SWITCH

# CHIAVI DI ACCENSIONE

# CONTACTEUR A CLÉ

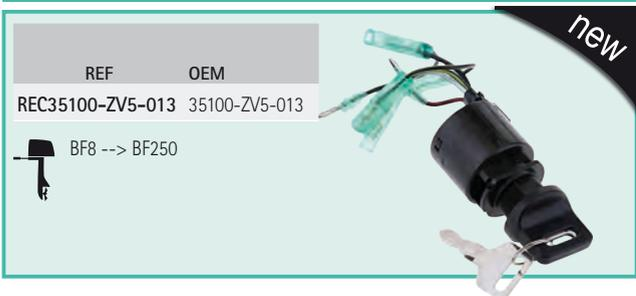

REF	OEM
REC35100-ZV5-013	35100-ZV5-013

BF8 --> BF250

# CABLES DE CONTROL

# CONTROL CABLES

# CAVI COMANDO

# CÂBLES DE COMMANDE

Recorrido trabajo: 76 mm.  
Rosca 10-32"

Travel 3"  
Threaded 10-32"

Estensione 76 mm  
Filetto 10-32"

Course: 76 mm.  
Fil 10-32

REF	RO	
PRE3300C05	24911-ZW7-U01	5' / 1,52 m
PRE3300C06	24912-ZW7-U01	6' / 1,83 m
PRE3300C07	24913-ZW7-U01	7' / 2,13 m
PRE3300C08	24914-ZW7-U01	8' / 2,45 m
PRE3300C09	24915-ZW7-U01	9' / 2,75 m
PRE3300C10	24916-ZW7-U01	10' / 3,05 m
PRE3300C11	24917-ZW7-U01	11' / 3,35 m
PRE3300C12	24918-ZW7-U01	12' / 3,65 m
PRE3300C13	24919-ZW7-U01	13' / 3,95 m
PRE3300C14	24920-ZW7-U01	14' / 4,25 m
PRE3300C15	24921-ZW7-U01	15' / 4,60 m
PRE3300C16	24922-ZW7-U01	16' / 4,90 m
PRE3300C17	24923-ZW7-U01	17' / 5,20 m
PRE3300C18	24924-ZW7-U01	18' / 5,50 m
PRE3300C19	24925-ZW7-U01	19' / 5,80 m
PRE3300C20	24926-ZW7-U01	20' / 6,10 m
PRE3300C21	24927-ZW7-U01	21' / 6,40 m
PRE3300C22	24928-ZW7-U01	22' / 6,70 m
PRE3300C23	24929-ZW7-U01	23' / 7,00 m
PRE3300C24	24930-ZW7-U01	24' / 7,30 m
PRE3300C25	24931-ZW7-U01	25' / 7,60 m
PRE3300C26	24932-ZW7-U01	26' / 7,90 m
PRE3300C27	24933-ZW7-U01	27' / 8,25 m
PRE3300C28	24934-ZW7-U01	28' / 8,55 m
PRE3300C29	24935-ZW7-U01	29' / 8,85 m
PRE3300C30	24936-ZW7-U01	30' / 9,15 m
PRE3300C31	24937-ZW7-U01	31' / 9,45 m
PRE3300C32	24938-ZW7-U01	32' / 9,75 m

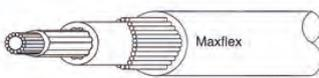

maxflex



HONDA

RECAMBIOS MARINOS

# SISTEMA DE REFRIGERACIÓN COOLING SYSTEM

# SISTEMA DI RAFFREDDAMENTO SYSTÈME DE REFROIDISSEMENT

## TERMOSTATO

## THERMOSTAT

## TERMOSTATO

## THERMOSTAT

### TERMOSTATOS

### THERMOSTATS

### TERMOSTATO

### THERMOSTATS

REF	OEM	°C
REC19300-881-761	19300-881-761	52°C



BF4.5B, BX, BK2, B2, B4, B6, BKO  
BF5AH, AK, AM, AX, AK2, A2, A3, A4  
BF15AH, AK, AM, B, A1, A2, A3, AX, AY, B2, BX  
F6B, BX  
BF8AX, B, BX, C, CX, AH, AK, AM  
BF100F  
BF75F  
BF9.9AH, AK, AM, B, AX, BX, AY



REF	OEM	°C
PAF15-07000031	19300-ZW9-003 19300-881-741 19300-921-003	60°C



BF25D4, DK2  
BF30D4, DK2  
BF40A, D, DK2, E  
BF50A, D, DK2  
BF8B1, B2, D1, D2, DK2, D3, D4  
BF9.9DK2, D1, D2, D3  
BF10B1, B1, D4, DK2, B2, D2  
BF15D3, DK2  
BF20D3

BF200A  
BF225A  
BF75DK0, DK2, DK3  
BF90DK0, DK2, DK4  
BF100A  
BF80A  
BF60A, AK1



REF	OEM	°C
REC67F-12411-01	19300-ZX2-003	60°C



BF175D,  
BF200D,  
BF225D,  
BF250A, D



new

REF	OEM	°C
REC19300-ZV5-043	19300-ZV5-003, 19300-ZV5-013, 19300-ZV5-023, 19300-ZV5-033, 19300-ZV5-043	72°C



BF35AM  
BF40B, B2, BX, AX, A1, A2,  
A3, AY  
BF45AM  
BF20AX, A  
BF25A, A1, AX  
BF30A, A1, AX, A2, A3

BF75A1, AT, AV, AX, A2, A3  
BF90A1, AT, AV, AX, A2, A3  
BF115A1, A2, AX  
BF130A1, A2, AX  
BF50A2, AX, A1, A3, AY  
BF20A2, A3  
BF25A1, A2, A3



REF	OEM	°C
REC6E5-12411-30	19300-ZY6-003	50°C



BF75DK0, DK2, DK3, DK4  
BF80A, AK1  
BF90DK0, DK2, DK4, DK5  
BF100A, AK1  
BF115D, DK1  
BF135A4, AK2  
BF150A4, AK2  
BFT80AK1  
BFT100AK1



new

REF	OEM	°C
REC6AH-12411-00	19300-ZY3-023	60°C



BF115A2, A3, D, DK1,  
BF130A2, A3,  
BF135A4, AK2,  
BF150A4, AK2,  
BF175A3, A6, AK1, AK2, AK3,  
BF200A2, A3, A6, AK1, AK2, AK3,  
BF225A2, A3, A6, AK1, AK2, K3,



new

## GUÍA TERMOSTATO

## THERMOSTAT GUIDE

## GUIDA TERMOSTATO

## GUIDE DES THERMOSTATS

REF	REF
B75K2	PAF15-07000031
B75K3	PAF15-07000031
BD115DK1	REC6E5-12411-30
BD130A2	REC19300-ZV5-043
BF100A	PAF15-07000031
BF100A	PAF15-07000031
BF100A	REC6E5-12411-30
BF100AK1	PAF15-07000031
BF100AK1	REC6E5-12411-30
BF100B	PAF15-07000031
BF100C	PAF15-07000031
BF100D	PAF15-07000031
BF100E	PAF15-07000031
BF100F	PAF15-07000031
BF100F	REC19300-881-761
BF10B1	PAF15-07000031
BF10B2	PAF15-07000031
BF10D1	PAF15-07000031

REF	REF
BF10D2	PAF15-07000031
BF10D4	PAF15-07000031
BF10DK2	PAF15-07000031
BF115A1	REC19300-ZV5-043
BF115A2	REC19300-ZV5-043
BF115A2	REC6AH-12411-00
BF115A3	REC6AH-12411-00
BF115D	REC6AH-12411-00
BF115D	REC6E5-12411-30
BF115DK1	REC6AH-12411-00
BF130A1	REC19300-ZV5-043
BF130A2	REC6AH-12411-00
BF130A3	REC6AH-12411-00
BF130AX	REC19300-ZV5-043
BF135A4	REC6AH-12411-00
BF135A4	REC6E5-12411-30
BF135AK2	REC6AH-12411-00
BF135AK2	REC6E5-12411-30

REF	REF
BF150A4	REC6AH-12411-00
BF150A4	REC6E5-12411-30
BF150AK2	REC6AH-12411-00
BF150AK2	REC6E5-12411-30
BF15A1	REC19300-881-761
BF15A2	REC19300-881-761
BF15A3	REC19300-881-761
BF15AH	REC19300-881-761
BF15AK	REC19300-881-761
BF15AM	REC19300-881-761
BF15AX	REC19300-881-761
BF15AY	REC19300-881-761
BF15B2	REC19300-881-761
BF15BX	REC19300-881-761
BF15D3	PAF15-07000031
BF15DK2	PAF15-07000031
BF15DK3	PAF15-07000031
BF175A3	REC6AH-12411-00

REF	REF
BF175A6	REC6AH-12411-00
BF175AK1	REC6AH-12411-00
BF175AK2	REC6AH-12411-00
BF175AK3	REC6AH-12411-00
BF175D	REC67F-12411-01
BF200A2	PAF15-07000031
BF200A2	REC6AH-12411-00
BF200A3	REC6AH-12411-00
BF200A6	REC6AH-12411-00
BF200AK1	REC6AH-12411-00
BF200AK2	REC6AH-12411-00
BF200AK3	REC6AH-12411-00
BF200D	REC67F-12411-01
BF20A	REC19300-ZV5-043
BF20A2	REC19300-ZV5-043
BF20AX	REC19300-ZV5-043
BF20D3	PAF15-07000031
BF20DK2	PAF15-07000031

HONDA

RECAMBIOS  
MARINOS



	REF
BF20DK3	PAF15-07000031
BF225A2	PAF15-07000031
BF225A2	REC6AH-12411-00
BF225A3	REC6AH-12411-00
BF225A6	REC6AH-12411-00
BF225AK1	REC6AH-12411-00
BF225AK2	REC6AH-12411-00
BF225AK3	REC6AH-12411-00
BF225D	REC67F-12411-01
BF250A	REC67F-12411-01
BF250D	REC67F-12411-01
BF25A	REC19300-ZV5-043
BF25A1	REC19300-ZV5-043
BF25A2	REC19300-ZV5-043
BF25A3	REC19300-ZV5-043
BF25AX	REC19300-ZV5-043
BF25D4	PAF15-07000031
BF25DK2	PAF15-07000031
BF30A	REC19300-ZV5-043
BF30A1	REC19300-ZV5-043
BF30A2	REC19300-ZV5-043
BF30A3	REC19300-ZV5-043
BF30AX	REC19300-ZV5-043
BF30D4	PAF15-07000031
BF30DK2	PAF15-07000031
BF35AM	REC19300-ZV5-043
BF4,5B	REC19300-881-761
BF4,5B2	REC19300-881-761
BF4,5B4	REC19300-881-761
BF4,5B6	REC19300-881-761
BF4,5BK0	REC19300-881-761
BF4,5BK2	REC19300-881-761
BF4,5BX	REC19300-881-761
BF4,9BH	REC19300-881-761
BF40A	REC19300-ZV5-043
BF40A1	REC19300-ZV5-043
BF40A2	REC19300-ZV5-043
BF40A3	REC19300-ZV5-043
BF40A4	PAF15-07000031
BF40AX	REC19300-ZV5-043
BF40AY	REC19300-ZV5-043

	REF
BF40B	REC19300-ZV5-043
BF40B2	REC19300-ZV5-043
BF40BX	REC19300-ZV5-043
BF40D	PAF15-07000031
BF40DK2	PAF15-07000031
BF40DK4	PAF15-07000031
BF40E	PAF15-07000031
BF45AM	REC19300-ZV5-043
BF4AH	REC19300-881-761
BF50A	REC19300-ZV5-043
BF50A1	REC19300-ZV5-043
BF50A2	REC19300-ZV5-043
BF50A3	REC19300-ZV5-043
BF50A4	PAF15-07000031
BF50AX	REC19300-ZV5-043
BF50AY	REC19300-ZV5-043
BF50D	PAF15-07000031
BF50DK2	PAF15-07000031
BF50DK4	PAF15-07000031
BF50F	REC19300-881-761
BF5A1	REC19300-881-761
BF5A2	REC19300-881-761
BF5A3	REC19300-881-761
BF5A4	REC19300-881-761
BF5AH	REC19300-881-761
BF5AK	REC19300-881-761
BF5AK2	REC19300-881-761
BF5AM	REC19300-881-761
BF5AX	REC19300-881-761
BF5DH	REC19300-881-761
BF60A	PAF15-07000031
BF60AK1	PAF15-07000031
BF6AH	REC19300-881-761
BF6B	REC19300-881-761
BF6BX	REC19300-881-761
BF6D6	PAF15-07000031
BF75A	PAF15-07000031
BF75A1	REC19300-ZV5-043
BF75A2	REC19300-ZV5-043
BF75A3	REC19300-ZV5-043
BF75AT	REC19300-ZV5-043

	REF
BF75AV	REC19300-ZV5-043
BF75AX	REC19300-ZV5-043
BF75B	PAF15-07000031
BF75C	PAF15-07000031
BF75D	PAF15-07000031
BF75D	PAF15-07000031
BF75DK0	REC6E5-12411-30
BF75DK2	PAF15-07000031
BF75DK2	REC6E5-12411-30
BF75DK3	PAF15-07000031
BF75DK3	REC6E5-12411-30
BF75DK4	PAF15-07000031
BF75DK4	REC6E5-12411-30
BF75DK0	PAF15-07000031
BF75E	PAF15-07000031
BF75F	PAF15-07000031
BF75F	REC19300-881-761
BF80A	PAF15-07000031
BF80A	REC6E5-12411-30
BF80AK1	PAF15-07000031
BF80AK1	REC6E5-12411-30
BF8AH	PAF15-07000031
BF8AH	REC19300-881-761
BF8AK	REC19300-881-761
BF8AM	PAF15-07000031
BF8AM	REC19300-881-761
BF8AX	REC19300-881-761
BF8B	REC19300-881-761
BF8B1	PAF15-07000031
BF8B2	PAF15-07000031
BF8BX	REC19300-881-761
BF8C	REC19300-881-761
BF8CX	REC19300-881-761
BF8D1	PAF15-07000031
BF8D2	PAF15-07000031
BF8D3	PAF15-07000031
BF8D4	PAF15-07000031
BF9,9AH	REC19300-881-761
BF9,9AK	REC19300-881-761
BF9,9AM	REC19300-881-761
BF9,9AX	REC19300-881-761

	REF
BF9,9AY	REC19300-881-761
BF9,9B	REC19300-881-761
BF9,9BX	REC19300-881-761
BF9,9D1	PAF15-07000031
BF9,9D2	PAF15-07000031
BF9,9D3	PAF15-07000031
BF9,9DK2	PAF15-07000031
BF90A1	REC19300-ZV5-043
BF90A2	REC19300-ZV5-043
BF90A3	REC19300-ZV5-043
BF90AT	REC19300-ZV5-043
BF90AV	REC19300-ZV5-043
BF90AX	REC19300-ZV5-043
BF90DK2	PAF15-07000031
BF90DK2	REC6E5-12411-30
BF90DK4	PAF15-07000031
BF90DK4	REC6E5-12411-30
BF90DK5	PAF15-07000031
BF90DK0	PAF15-07000031
BF90DK0	REC6E5-12411-30
BF990DK5	REC6E5-12411-30
BFDK2	PAF15-07000031
BF10B1	PAF15-07000031
BFP10B2	PAF15-07000031
BFP10D1	PAF15-07000031
BFP10D2	PAF15-07000031
BFP60A	PAF15-07000031
BFP60AK1	PAF15-07000031
BFP8B1	PAF15-07000031
BFP8B2	PAF15-07000031
BFP8D2	PAF15-07000031
BFP8D3	PAF15-07000031
BFP9,9D1	PAF15-07000031
BFP9,9D2	PAF15-07000031
BFP9,9D3	PAF15-07000031
BFPD1	PAF15-07000031
BFT100AK1	PAF15-07000031
BFT100AK1	REC6E5-12411-30
BFT80AK1	PAF15-07000031
BFT80AK1	REC6E5-12411-30

**IMPULSORES      IMPELLERS      GIRANTE      TURBINES**

IMPULSORES	IMPELLER	GIRANTE	TURBINES								
<table border="1"> <thead> <tr><th>REF</th><th>OEM</th></tr> </thead> <tbody> <tr><td>REC19210-ZV4-651</td><td>19210-ZV4-651</td></tr> </tbody> </table>  <p>BF8C, CX BF9,9AM, AX, B, BX BF15A1, A2, A3, AM, AX, AY, B, B2, BX</p>	REF	OEM	REC19210-ZV4-651	19210-ZV4-651		<table border="1"> <thead> <tr><th>REF</th><th>OEM</th></tr> </thead> <tbody> <tr><td>REC19210-ZW9-013</td><td>19210-ZW9-013 19210-ZW9-003</td></tr> </tbody> </table>  <p>BF8B1, B2, D1, D2, D3, D4, DK2 BF9,9D1, D2, D3, DK2 BF10B1, B2, D1, D2, D4, DK2 BFP8B1, B2, D1, D2, D3 BFP9,9D1, D2, D3 BFP10B1, B2, D1, D2</p>	REF	OEM	REC19210-ZW9-013	19210-ZW9-013 19210-ZW9-003	
REF	OEM										
REC19210-ZV4-651	19210-ZV4-651										
REF	OEM										
REC19210-ZW9-013	19210-ZW9-013 19210-ZW9-003										
<table border="1"> <thead> <tr><th>REF</th><th>OEM</th></tr> </thead> <tbody> <tr><td>REC47-43026Q02</td><td>19210-ZW1-303</td></tr> </tbody> </table>  <p>BF75 BF90AT</p>	REF	OEM	REC47-43026Q02	19210-ZW1-303		<table border="1"> <thead> <tr><th>REF</th><th>OEM</th></tr> </thead> <tbody> <tr><td>REC19210-ZV4-013</td><td>19210-ZV4-013</td></tr> </tbody> </table>  <p>BF9,9AH, AK, AM BF15AH, AK, AM</p>	REF	OEM	REC19210-ZV4-013	19210-ZV4-013	
REF	OEM										
REC47-43026Q02	19210-ZW1-303										
REF	OEM										
REC19210-ZV4-013	19210-ZV4-013										
<table border="1"> <thead> <tr><th>REF</th><th>OEM</th></tr> </thead> <tbody> <tr><td>REC19210-ZY9-H01</td><td>19210-ZY9-H01</td></tr> </tbody> </table>  <p>F75DK3, DK4 BF80A, AK1 BF90DK4, DK5 BF100A, AK1</p>	REF	OEM	REC19210-ZY9-H01	19210-ZY9-H01		<table border="1"> <thead> <tr><th>REF</th><th>OEM</th></tr> </thead> <tbody> <tr><td>REC19210-ZV7-003</td><td>19210-ZV7-003</td></tr> </tbody> </table>  <p>BF20A, A2, AX BF25A, A1, A2, A3, AX, D4, DK2 BF30A, A1, A2, A3, AX, D4, DK2</p>	REF	OEM	REC19210-ZV7-003	19210-ZV7-003	
REF	OEM										
REC19210-ZY9-H01	19210-ZY9-H01										
REF	OEM										
REC19210-ZV7-003	19210-ZV7-003										

REF	OEM
REC19210-881-003	19210-881-003 19210-881-A01 19210-881-A02



 BF4,5B, B2, B4, B6, BK0, BK2, BX  
 BF5A1, A2, A3, A4, AH, AK, AK2, AX  
 BF6B, BZ, D6  
 BF8AH, AK, AM, AX, B, BX  
 BF50F  
 BF75A, B, C, D, E  
 BF100A, B, C, D, E, F

REF	OEM
REC19210-ZW9-A32	19210-ZW9-A31, 19210-ZW9-A32



 BF8B1, B2, D1, D2, D3  
 BF9,9DK2  
 BF10D2, D4, DK2  
 BF15D3, DK2, DK3  
 BF20D3, DK2, DK3  
 BFP8B1, B2, D1, D2, D3  
 BFP9,9D, D1, D2  
 BFP10B1, B2, D1, D2

REF	OEM
REC19210-ZY3-003	19210-ZY3-003



 BF175A3, A6, AK1, AK2, AK3, D  
 BF200A2, A3, A6, AK1, AK2, AK3, D  
 BF225A, A2, A, A6, AK1, AK2, D  
 BF250A, D

REF	OEM
REC19210-ZV5-003	19210-ZV5-003



 BF35AM  
 BF40A, A1, A2, A3, A4, AX, AY, B,  
 B2, BX, D, DK2, DK4, E  
 BF45AM  
 BF50A, A1, A2, A3, AX, AY, D, DK2,  
 DK4  
 BF60A, AK1  
 BFP60A, AK1

REF	OEM
REC19210-ZW1-B02	19210-ZW1-B02 19210-ZW1-B03 19210-ZW1-B04



 BF75A1, A2, A3, AV, AX, DK0, DK2  
 BF90A1, A2, A3, AV, AX, DK0, DK2  
 BF115A1, A2, A3, AX, D, DK1  
 BF130A1, A2, A3, AX  
 BF135A4, AK2  
 BF150A4

GUÍA DE IMPULSORES

IMPELLER GUIDE

GUIDA GIRANTE

GUIDE DES TURBINES

	REF	CEF	A (mm)	B (mm)	C (mm)
	REC19210-ZY9-H01				
	REC19210-881-003				
	REC19210-ZW9-013	CEF500347	13	45,6	14,8
	REC19210-ZW9-A32	CEF500348	16,2	45,6	14,8
	REC19210-ZW1-B02	CEF500337	23,35	87,8	31
	REC19210-ZW1-B02	CEF500337	23,35	87,8	31
	REC19210-ZW1-B02	CEF500337	23,35	87,8	31
	REC19210-ZW1-B02	CEF500337	23,35	87,8	31
	REC19210-ZW1-B02	CEF500337	23,35	87,8	31
	REC19210-ZV4-651	CEF500343	14,1	41	27,55
	REC19210-ZV4-013	CEF500328	14,2	41	27,55
	REC19210-ZW9-A32	CEF500348	16,2	45,6	14,8
	REC19210-ZY3-003	CEF500391	26	89,75	31,3
	REC19210-ZY3-003	CEF500391	26	89,75	31,3
	REC19210-ZV7-003	CEF500339	17,2	55,75	20,2
	REC19210-ZW9-A32	CEF500348	16,2	45,6	14,8
	RM19211-ZV0-003		10,5	40	22,5
	REC19210-ZY3-003	CEF500391	26	89,75	31,3
	REC19210-ZY3-003	CEF500391	26	89,75	31,3
	REC19210-ZV7-003	CEF500339	17,2	55,75	20,2
	REC19210-ZV7-003	CEF500339	17,2	55,75	20,2
	REC19210-ZV5-003	CEF500338	17,2	55,9	20,2
	REC19210-881-003				
	REC19210-ZV5-003	CEF500338	17,2	55,9	20,2
	REC19210-ZV5-003	CEF500338	17,2	55,9	20,2
	REC19210-ZV5-003	CEF500338	17,2	55,9	20,2
	REC19210-881-003				
	REC19210-ZV5-003	CEF500338	17,2	55,9	20,2
	REC19210-881-003				
	REC47-43026Q02	CEF500301	22,4	89	32,5
	REC19210-881-003				

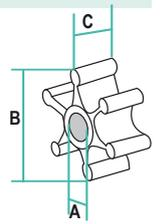

	REF	CEF	A (mm)	B (mm)	C (mm)
	REC19210-ZW1-B02	CEF500337	23,35	87,8	31
	REC19210-881-003				
	REC19210-ZY9-H01				
	REC19210-881-003				
	REC19210-ZW9-013	CEF500347	13	45,6	14,8
	REC19210-ZW9-A32	CEF500348	16,2	45,6	14,8
	REC19210-881-003				
	REC19210-ZV4-651	CEF500343	14,1	41	27,55
	REC19210-ZW9-013	CEF500347	13	45,6	14,8
	REC19210-ZW9-A32	CEF500348	16,2	45,6	14,8
	REC19210-ZV4-013	CEF500328	14,2	41	27,55
	REC19210-ZV4-651	CEF500343	14,1	41	27,55
	REC19210-ZW9-013	CEF500347	13	45,6	14,8
	REC19210-ZW9-A32	CEF500348	16,2	45,6	14,8
	REC19210-ZW1-B02	CEF500337	23,35	87,8	31
	REC47-43026Q02	CEF500301	22,4	89	32,5
	REC19210-ZW1-B02	CEF500337	23,35	87,8	31
	REC19210-ZY9-H01				
	REC19210-ZW9-013	CEF500347	13	45,6	14,8
	REC19210-ZW9-A32	CEF500348	16,2	45,6	14,8
	REC19210-ZV5-003	CEF500338	17,2	55,9	20,2
	REC19210-ZW9-013	CEF500347	13	45,6	14,8
	REC19210-ZW9-A32	CEF500348	16,2	45,6	14,8
	REC19210-ZW9-A32	CEF500348	16,2	45,6	14,8
	REC19210-ZW9-A32	CEF500348	16,2	45,6	14,8
	REC19210-ZW9-013	CEF500347	13	45,6	14,8
	REC19210-ZW9-A32	CEF500348	16,2	45,6	14,8
	REC19210-ZW9-013	CEF500347	13	45,6	14,8
	REC19210-ZW9-A32	CEF500348	16,2	45,6	14,8
	REC19210-ZY9-H01				
	REC19210-ZY9-H01				

CHAVETA		KEY	CIAVETTA		CLAVETTE						
<table border="1"> <thead> <tr> <th>REF</th> <th>OEM</th> </tr> </thead> <tbody> <tr> <td>REC90752-ZV4-650</td> <td>90752-ZV4-650</td> </tr> </tbody> </table> <p>            BF8C, CX            BF9.9AM, B, AX, BX, AY            BF15AM, B, A1, A2, AX, B2, BX, A3, AY         </p>	REF	OEM	REC90752-ZV4-650	90752-ZV4-650		<table border="1"> <thead> <tr> <th>REF</th> <th>OEM</th> </tr> </thead> <tbody> <tr> <td>REC90752-ZV5-003</td> <td>90752-ZV5-003</td> </tr> </tbody> </table> <p>            BF60A, AK1            BF50A4, D, DK2, A, A1, A2, AX, A3, AY            BF35AM            BF40B, B2, BX, D, DK2, A, A1, A2, AX, E, A3, AY, A4            BF45AM         </p>	REF	OEM	REC90752-ZV5-003	90752-ZV5-003	
REF	OEM										
REC90752-ZV4-650	90752-ZV4-650										
REF	OEM										
REC90752-ZV5-003	90752-ZV5-003										
<table border="1"> <thead> <tr> <th>REF</th> <th>OEM</th> </tr> </thead> <tbody> <tr> <td>REC90752-ZV7-000</td> <td>90752-ZV7-000</td> </tr> </tbody> </table> <p>            BF25D4, DK2, A, A1, AX, A2, A3            BF30D4, DK2, A, A1, AX, A2, A3            BF20A, AX, A2         </p>	REF	OEM	REC90752-ZV7-000	90752-ZV7-000		<table border="1"> <thead> <tr> <th>REF</th> <th>OEM</th> </tr> </thead> <tbody> <tr> <td>REC90752-ZY3-003</td> <td>90752-ZY3-003</td> </tr> </tbody> </table> <p>            BF225A2, A3, A6, AK2, AK3            BF175A3, A6, AK1, AK2, AK3            BF200A2, A3, A6, AK1, AK2, AK3            BF250A, AK1         </p>	REF	OEM	REC90752-ZY3-003	90752-ZY3-003	
REF	OEM										
REC90752-ZV7-000	90752-ZV7-000										
REF	OEM										
REC90752-ZY3-003	90752-ZY3-003										
<table border="1"> <thead> <tr> <th>REF</th> <th>OEM</th> </tr> </thead> <tbody> <tr> <td>REC90752-ZW1-B02</td> <td>90752-ZW1-B02 9075-ZW1-003</td> </tr> </tbody> </table> <p>            BF80A, BF100A            BF150A4, AK2            BF75A1, AV, AX, DK2, DK3, A2, A3            BF90A1, AV, AX, DK0, DK2, DK4, A2, A3            BF115A1, A2, A3, AX, D, DK1            BF130A1, A2, A3, AX            BF135A4, AK2         </p>	REF	OEM	REC90752-ZW1-B02	90752-ZW1-B02 9075-ZW1-003							
REF	OEM										
REC90752-ZW1-B02	90752-ZW1-B02 9075-ZW1-003										

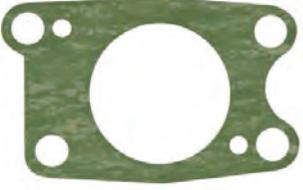
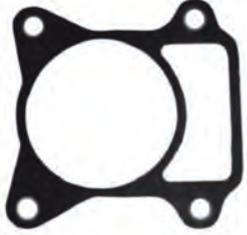
BOMBA DE AGUA		WATER PUMP	POMPA ACQUA		POMPE À EAU								
JUNTAS BOMBA	WATER PUMP GASKET	GUARNIZIONE POMPA	JOINTS DE POMPE A EAU										
<table border="1"> <thead> <tr> <th>REF</th> <th>OEM</th> </tr> </thead> <tbody> <tr> <td>REC8172761</td> <td>19231-ZW1-003</td> </tr> </tbody> </table> <p>            BF75A            BF90A         </p>	REF	OEM	REC8172761	19231-ZW1-003		<table border="1"> <thead> <tr> <th>REF</th> <th>OEM</th> </tr> </thead> <tbody> <tr> <td>REC19232-ZV1-A10</td> <td>19232-ZV1-A10</td> </tr> </tbody> </table> <p>            BF4.5B, BX, BK2, B2, B4, B6, BK0            BF5A1, AM, AX, AK2, A2, A3, A4         </p>	REF	OEM	REC19232-ZV1-A10	19232-ZV1-A10			
REF	OEM												
REC8172761	19231-ZW1-003												
REF	OEM												
REC19232-ZV1-A10	19232-ZV1-A10												
<table border="1"> <thead> <tr> <th>REF</th> <th>OEM</th> </tr> </thead> <tbody> <tr> <td>REC19232-881-850</td> <td>19232-881-850</td> </tr> </tbody> </table> <p>            BF6B, BX, D6            BF8AX, B, BX, AK, AM         </p>	REF	OEM	REC19232-881-850	19232-881-850		<table border="1"> <thead> <tr> <th>REF</th> <th>OEM</th> </tr> </thead> <tbody> <tr> <td>REC19242-ZV5-000</td> <td>19242-ZV5-000</td> </tr> </tbody> </table> <p>            BF20A, AX, A2            BF35AM            BF40B, B2, BX, A4, D, DK2, AA1, A2, AX, A3, AY            BF45AM            BF25D4, DK2, A, A1, AX, A2, A3            BF50A4, D, DK2, A, A1, A2, A3, AY            BF30D4, DK2, A, A1, AX, A2, A3         </p>	REF	OEM	REC19242-ZV5-000	19242-ZV5-000			
REF	OEM												
REC19232-881-850	19232-881-850												
REF	OEM												
REC19242-ZV5-000	19242-ZV5-000												
<table border="1"> <thead> <tr> <th>REF</th> <th>OEM</th> </tr> </thead> <tbody> <tr> <td>REC19234-881-850</td> <td>19234-881-850</td> </tr> </tbody> </table> <p>            BF6B, BX, D6            BF8AX, B, BX, AK, AM         </p>	REF	OEM	REC19234-881-850	19234-881-850		<table border="1"> <thead> <tr> <th>REF</th> <th>OEM</th> </tr> </thead> <tbody> <tr> <td>REC27-430331</td> <td>19234-ZW1-003</td> </tr> </tbody> </table> <p>            BF75A            BF90A         </p>	REF	OEM	REC27-430331	19234-ZW1-003			
REF	OEM												
REC19234-881-850	19234-881-850												
REF	OEM												
REC27-430331	19234-ZW1-003												

REF	OEM
REC27-430472	19242-ZW1-003
	BF75A BF90A



REF	OEM
REC19234-ZY3-000	19234-ZY3-000
	BF175A3, A6, AK1, AK2, AK3 BF200A2, A3, A6, AK1, AK2, AK3 BF225A2, A3, A6, AK1, AK2, AK3



REF	OEM
REC19232-ZV4-610	19232-ZV4-610
	BF15AK, AM, B, A1, A2, AX, B2, BX, A1, A2, A3, AY BF9.9AK, AM, B, AX, BX, AY BF8C, CX



REF	OEM
REC19233-ZV5-000	19233-ZV5-000
	BF35AM BF40B, B2, BX, A4, D, DK2, A, A1, 2, AX, AY BF45AM BF25D4, DK2, A, A1, AX, A2, A3 BF30D4, K2, A, A1, AX, AZ, A3 BF50A4, D, DK2, A, A1, A2, AX



REF	OEM
REC27-8172771	19232-ZW1-003
	BF75A BF90A



**RETÉN CUERPO DE BOMBA**      **SEAL WATER PUMP**      **TENUTE CORPO POMPA**      **JOINTS SPI DE POMPE À EAU**

REF	OEM
REC91252-ZV1-003	91252-ZV1-003
	B4.5B, BX, BK2, B4, B6 BF5A1, H, AK, AM, AX, AK2, A2, A3, A4 BF8B1, D1, D2, B2, DK2, D3, D4 BF9.9DK2, D1, D2, D3 BF10B1, D1, D4, DK2, B2, D2 BF50F



REF	OEM
REC91252-935-004	91252-935-004
	BF9.9A BF15A BF100A, B, C, D, E, F BF75A, B, C, D, K2, K3, E, F BF15AH, AK, AM, B, A1, A2, AX, B2, BX, A3, AY BF9.9AH, AK, AM, B, AX, BX, AY BF6BX, D6 BF8AX, B, BX, C, CX, AH, AK, AM



**KITS DE REPARACIÓN BOMBA DE AGUA**      **WATER PUMP SERVICE KITS**

REF	OEM
REC06192-ZV1-C00	06192-ZV1-C00 06192-ZV1-000
	BF4.5B, BK2, BK0 BF5A1, AM, AX, AK2, A2, A3, A4



**KIT RICAMBI POMPA ACQUA**      **KIT POMPE À EAU**

REF	OEM
REC06193-ZV5-020	06193-ZV5-020 06193-ZV5-000 06193-ZV5-010
	BF40A4, D, DK2, DK4 BF50A4, D, DK2, DK4



**new**

REF	OEM
REC06192-881-C00	06192-881-C00
	BF6B, BX, D6 BF8AX, B, BX, AM



REF	OEM
REC06192-ZW9-A30	06192-ZW9-A30
	BFP8D, BF8B2, BF8D2 BFP9.9D (XL) BF15D BF20D BF10D BFP10D

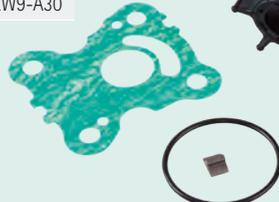

**new**

REF	OEM
REC06192-ZV4-000	06192-ZV4-000 19210-ZV4-651

 BF8C, CX  
 BF9.9A  
 BF15A2, A3, B2



REF	OEM
REC06192-ZV1-305	06192-ZV1-305 06192-ZW1-305

 BF75AT  
 BF90AT



REF	OEM
REC06192-ZV7-000	06192-ZV7-000 06192-ZW2-000

 BF25D4, DK2, A2, A3  
 BF30D4, DK2, A2, A3  
 BF20A2

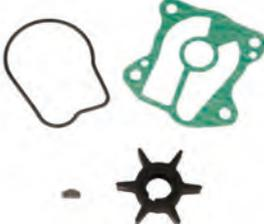

REF	OEM
REC06192-ZV1-000	06192-ZW1-000 06192-ZV1-000

 BF115A2, A3  
 BF130A2, A3  
 BF75DK0, DK1, A2, A3, DK2  
 BF90 DK0, DK1, A2, A3, DK2

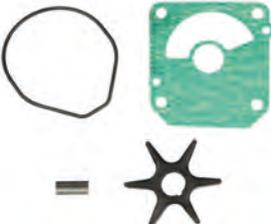

REF	OEM
REC06192-ZV5-003	06192-ZV5-003

 BF35AM  
 BF40B, B2, BX, A4, D, DK2, AA1,A2, AX, A3  
 BF45AM  
 BF50A4, D, DK2, A, A21, A2, AX,A3



REF	OEM
REC06192-ZY6-000	06192-ZY6-000

 BF115D, DK1  
 BF135A4, AK2  
 BF150A4, AK2

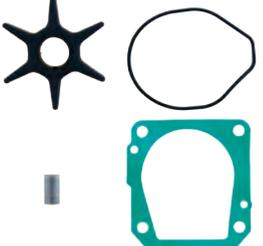

REF	OEM
REC47-43026Q06	19021-ZW1-003

 BF75AT  
 BF90AT



REF	OEM
REC06192-ZY3-000	06192-ZY3-000 06192-ZX2-000

 BF175A3, A6, AK1, AK2, AK3  
 BF200A2, A3, A6, AK1, AK2, AK3  
 BF225A2, A3, A6, AK1, AK2, AK3  
 BF250A

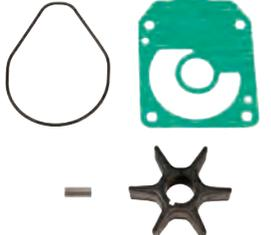

ÁNODO ANODE ANODI ANODE

ZN	KG (kg)	AL	KG (kg)	OEM
CM06411-ZV5-000	0,36	CM06411-ZV5-000A	0,14	06411-ZV5-000 06411-ZV5-020

 BF35, 40, 45, 50  
 150 x 35 mm



ZN	KG (kg)	AL	KG (kg)	OEM
CM826134	0,25	CM826134A	0,10	41109-ZW1-003 12155-ZV5-000

 BF20-->BF250 HP



ZN	KG (kg)	AL	KG (kg)	OEM
CM06411-ZW1-000	0,83	CM06411-ZW1-000A	0,33	06411-ZW1-000 06411-ZW1-020

 BF75 --> BF225 HP  
 220 x 50 mm



ZN	KG (kg)	AL	KG (kg)	OEM
CM41109-ZW1-B00	0,22	CM41109-ZW1-B00A	0,11	41109-ZW1-B00

 BF40-->BF250 HP



ZN	(KG)	AL	(KG)	OEM
CM6E0-45251-11	0,10	CM6E0-45251-11A	0,04	2155-ZV5-000

BF2-->BF250 HP



ZN	(KG)	AL	(KG)	OEM
CM41107-ZW1-B01	0,44	CM41107-ZW1-B01A	0,20	41107ZW1-B01

BF75-->BF130 HP



ZN	(KG)	AL	(KG)	OEM
CM41106-ZW9-09000	0,99	CM41106-ZW9-000A		41106ZW909000 41106-ZW9-000

BF8-->BF50HP



ZN	(KG)	AL	(KG)	OEM
CM31640	0,45	CM31640A	0,21	06412-ZV1-000 411072ZW1003

BF75, 90, 115, 130



ZN	(KG)	AL	(KG)	OEM
CM41107-ZV500	0,29	CM41107-ZV500A	0,11	41107ZV500 06412-ZV5-000

BF20--> BF50HP



ZN	(KG)	AL	(KG)	OEM
CM664-45371-01	0,27	CM664-45371-01A	0,10	064-45371-01

BF20--> BF50HP



KITS DE ÁNODOS

ANODES KIT

KIT ANODI

KIT ANODES

AL	MG
CMHBF4050KITA	CMHBF4050KITM

BF40 --> BF50



new

AL	MG
CMHBF35225KITA	CMHBF35225KITM

BF35 --> BF225



new

AL	MG
CMHBF75115KITA	CMHBF75115KITM

BF90 --> BF115



new

ÁNODO

ANODE

ANODI

ANODE

ZN	OEM	KG (KG)
TEN01404	06411-ZV5-000 06411-ZV5-020	0,380



BF35-->BF50 HP

ZN	OEM	KG (KG)
TEN01401	41106-935-812	0,080



Serie 8 /25HP

ZN	OEM	KG (KG)
TEN01406	06411-ZV1-000	0,860



BF75-->BF225 HP

ZN	OEM	KG (KG)
TEN01402	41106-ZV4-650	0,090



BF2-->BF15 HP

ZN	OEM	KG (KG)
TEN01405	06411-ZV1-000	0,250



Serie 75 - 130 HP

ZN	OEM	KG (KG)
TEN01400	41106-ZW-000	0,020

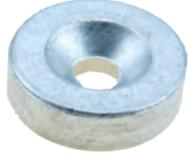

Serie 8 /25HP

ZN	OEM	KG (KG)
TEN01407	41109-ZW1-B00	0,230



BF40-->BF250 HP

ZN	OEM	KG (KG)
TEN01412	06412-ZV5-000	0,210



ZN	OEM	KG (KG)
TEN01408	12155-ZV4-A00	0,040



BF8->BF250 HP

ZN	OEM	KG (KG)
TEN01403	41107-ZV5-000	0,280



BF20-->BF50 HP

ZN	OEM	KG (KG)
TEN01408/1	12155-ZV5-000	0,030



BF20-->BF250 HP

ZN	OEM	KG (KG)
TEN01410	41107-ZW1-B01ZA	0,550



Serie 75 - 90 - 115 - 130 HP

ZN	OEM	KG (KG)
TEN01409	41106-ZW9-000	0,050



BF8-->BF50 HP

ZN	OEM	KG (KG)
TEN01411	41107-ZV1-003-ZA	0,480



BF75-->BF130 HP

KITS DE ÁNODOS

ANODES KIT

KIT ANODI

KIT ANODES

ZN	
TENKITHONDABF	TEN01410 x 1 TEN01406 x 1 TEN01407 x 2



BF75+

# PARTES DEL MOTOR ENGINE PARTS

# PARTI MOTORE PIECES MOTEUR

## JUNTAS DE MOTOR ENGINE GASKET

## GUARNIZIONI DE MOTORE

## JOINTS DE MOTEUR

### JUNTAS DE CULATA

### CYLINDER HEAD GASKET

### GUARNIZIONE DE TESTATA

### JOINTS DE CULASSE

REF	OEM
REC12251-ZV7-004	12251-ZV7-004

- BF20A, A2, AX
- BF25A, A1, 2, A3, AX
- BF30A, A1, A2, A3, AX
- VF25A2



REF	OEM
REC12251-ZW1-014	12251-ZW1-014 12251-ZW1-004

- BF40A4, D, K2, DK4
- BF50A4, BF50D, DK2, DK4



REF	OEM
REC12251-ZV5-003	12251-ZW4-H01 12251-ZV5-000/03

- BF35AM
- BF40B, BX, A, A1, AX, AY, A4, D, DK2, DK4
- BF45AM
- BF50A, A1, A4, AX, AY, D, DK2, DK4

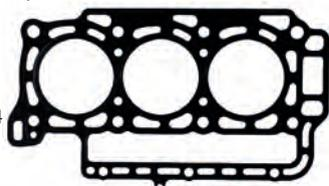

REF	OEM
REC12251-ZW5-023	12251-ZW5-023 12251-ZW5-000/013

- BF115A1, A2, A3, AX
- BF130A1, A2, A3, AX



## JUNTAS BASE DE MOTOR CYLINDER GASKET

## GUARNIZIONE BASE MOTORE

## JOINTS DE TÊTE MOTRICE

REF	OEM
REC23172-ZW1-013	23172-ZW1-013

- BF75A1, A2, A3
- BF90A1, A2, A3

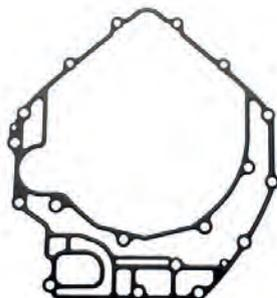

REF	OEM
REC23172-ZW5-013	23172-ZW5-013 23172-ZW5-000

- BF115A1, A2, A3, AX
- BF130A1, A2, A3, AX



## JUNTAS BOMBA ACEITE GASKET, OIL PUMP

## GUARNIZIONE POMPA OLIO

## JOINTS DE POMPE A HUILE

REF	OEM
REC15112-ZW5-003	15112-ZW5-003

- BF115A1, A2, A3, AX
- BF130A1, A2, A3, AX

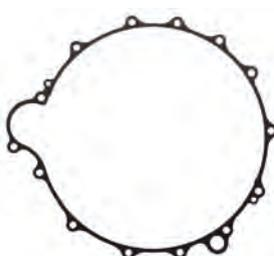

## JUNTAS SILENCIOSO GASKET, MUFFLER

## GUARNIZIONE SILENZIATORE

## JOINTS DE SILENCIEU

REF	OEM
REC17384-ZW4-000	17384-ZW4-000

- BF25D4, DK2, A4
- BF30D4, DK2, A4





**KIT DE JUNTAS**

**GASKET KIT**

**KIT GUARNIZIONE**

**KIT JOINTS**

REF	OEM
RM061A1-ZV0-000	061A1-ZV0-000



BF20F



REF	OEM
RM06111-ZW1-020	06111-ZW1-000 06111-ZW1-020



BF75A1, AT, AV, AX  
BF90, A1, AT, AV, AX



**JUNTA TAPÓN DE DRENAJE**

**O-RING DRAIN CAP**

**GUARNIZIONE TAPPO DRENAGIO**

**JOINT DE VIDANGE**

REF	OEM
REC12-191833	12-191833



**CORREAS DE DISTRIBUCIÓN**

**TIMING BELT**

**CINGHIE DISTRIBUZIONE**

**COURROIES DE DISTRIBUTION**

REF	OEM
RM14400-921-024	14400-921-024 14400-921-010



F8AX, B, BX, AH, AK, AM  
BF6BX, D6  
BF75A, B, C, D, K2, K3, E, F  
BF100A, B, C, D, E, F



REF	OEM
RM14400-ZV4-004	14400-ZV4-004



BF8C, CX  
BF9.9AH, AK, AM, B, AX, BX, AY  
BF15AH, AK, AM, B, A1, A2, AX, B2, A3, AY



REF	OEM
REC14400-ZV5-014	14400-ZV5-004 14400-ZV5-014



BF35AM  
BF40B, B2, BX, A, A1, A2, AX, AY  
BF45AM  
BF50A, A1, A2, AX, AY



REF	OEM
REC14400-ZZ3-004	14400-ZZ3-004



BF60A, AK1  
BFP60AK1  
BF40E



REF	OEM
RM14400-ZW1-004	14400-ZW1-004



BF75A1, AT, AV, AX, A2, A3  
BF90A1, AT, AV, AX, A2, A3



# SISTEMA DE ESCAPE Y ADMISIÓN EXHAUST & INTAKE SYSTEM

# SISTEMA DI SCARICO E ASPIRAZIONE SYSTÈME D'ÉCHAPPEMENT ET D'ADMISSION

## SISTEMA DE ESCAPE

## EXHAUST SYSTEM

## SISTEMA SCARICO

## SYSTÈME D'ÉCHAPPEMENT

### RETÉN VÁLVULA

### VALVE SEALS

### TENUTE

### JOINT DE SOUPAPE

REF	OEM
REC12209-6B4-681	12209-GB4-681

- BF8B1, B2, D1, D2, DK2, D3, D4
- BF9.9DK2, D1, D2, D3
- BF10B1, D1, D4, DK2, D2



## SISTEMA DE ADMISIÓN

## INTAKE SYSTEM

## SISTEMA ASPIRAZIONE

## SYSTÈME D'ADMISSION

### RETÉN VÁLVULA

### VALVE SEALS

### TENUTE

### JOINT DE SOUPAPE

REF	OEM
REC12209-6B4-681	12209-GB4-681

- BF8B1, B2, D1, D2, DK2, D3, D4
- BF9.9DK2, D1, D2, D3
- BF10B1, D1, D4, DK2, D2



### JUNTAS

### GASKET,

### GUARNIZIONE

### JOINT

REF	OEM
REC16221-ZW9-000	16221-ZW9-000

- BF8B1, B2, D1, D2, DK2, D3, D4
- BF9.9DK2, D1, D2, D3
- BF10B1, D1, D4, DK2, B2, D2



REF	OEM
REC17109-ZY6-000	17109-ZY6-000

- BF115D, DK1
- BF135A4, AK2
- BF150A4, AK2
- BF75DK0, DK2, DK3
- BF90DK0, DK2, DK4
- BF100A
- BF80A



REF	OEM
REC16201-881-850	16201-881-850

- BF6B, BX, D6
- BF8AX, B, BX, AK, AM



REF	OEM
REC17105-ZY6-000	17105-ZY6-000

- BF115D, DK1
- BF135A4, AK2
- BF150A4, AK2



REF	OEM
REC16221-ZV4-610	16221-ZV4-610

- BF15AK, AM, B, A1, A2, AX, B2, BX, A3, A4
- BF9.9AK, AM, B, AX, BX, AY
- BF8C, CX



REF	OEM
REC17109-ZY3-004	17109-ZY3-004

- BF250A
- BF175A3, A6, AK1, AK2, AK3
- BF200A2, A3, A6, AK1, AK2, AK3
- BF225A2, A3, A6, AK1, AK2, AK3



REF	OEM
REC16221-ZW1-000	16221-ZW1-000

- BF75A1, AT, AV, AX, A2, A3
- BF90A1, AT, AV, AX, A2, A3



REF	OEM
REC17151-ZW5-000	17151-ZW5-000

- BF115A1, A2, A3, AX
- BF130A1, A2, A3, AX

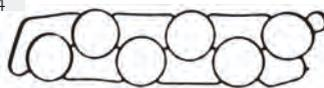

REF	OEM
REC17105-ZY3-004	17105-ZY3-004

- BF250A
- BF175A3, A6, AK1, AK2, AK3
- BF200A2, A3, A6, AK1, AK2, AK3
- BF225A2, A3, A6, AK1, AK2, AK3



# UNIDADES DE TRANSMISIÓN UNIT DRIVES & COMPONENTS

# UNITÀ DI TRASMISSIONE EMBASES ET PIECES

DESPIECE COLAS

GEAR CASE PARTS

PARTI PIEDI

PIECES D'EMBASSES

BF75AT • BF90AT

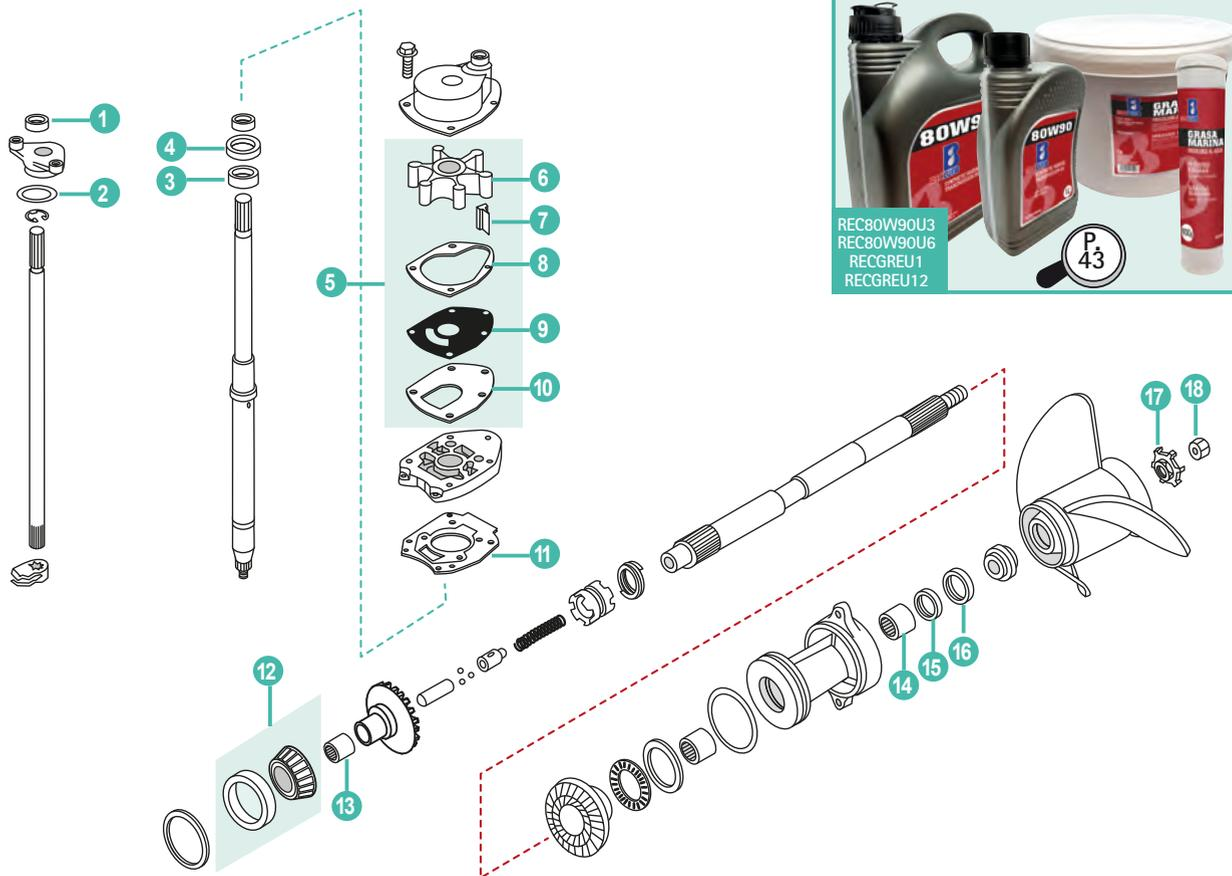

	REF	OEM				
1	REC26-8164641	91253-ZW1-003	RETÉN ACEITE	OIL SEAL	PARAOLIO	JOINT SPI
2	REC25-457101	91353-ZW1-003	TORICA	O-RING	O-RING	JOINT TORIQUE
3	REC26-43036	91254-ZW1-003	RETÉN ACEITE	OIL SEAL	PARAOLIO	JOINT SPI
4	REC26-43035	91251-ZW1-003	RETÉN ACEITE	OIL SEAL	PARAOLIO	JOINT SPI
5	REC47-43026Q06	19021-ZW1-003	KIT BOMBA AGUA	WATER PUMP KIT	KIT POMPA ACQUA	KIT POMPE À EAU
6	REC47-43026Q02	19120-ZW1-303	IMPULSOR	IMPELLER	GIRANTE	TURBINE
7	REC90752-ZW1-B02	90752-ZW1-003	CHAVETA IMPELLER	KEY	CHIUSURA	CLAVETTE TURBINE
8	REC27-8172771	19232-ZW1-003	JUNTA DE LA BOMBA	GASKET PUMPCASE	GUARNIZIONE POMPA	JOINT DE POMPE
9	REC8172761	19231-ZW1-003	BASE INOX	OUTER PLATE	PIASTRA INOX	BASE INOX
10	REC27-430331	19234-ZW1-003	JUNTA DE LA BOMBA	GASKET PUMPCASE	GUARNIZIONE POMPA	JOINT DE POMPE
11	REC27-430472	19242-ZW1-003	JUNTA	GASKET	GUARNIZIONE	JOINT
12	REC31-30894A1	91051-ZW1-003	RODAMIENTO AVAN.	BEARING FORWARD	CUSCINETTO AVANTI	ROULEMENT MARCHE AVANTE
13	REC31-30895T	91057-ZW1-003	RODAMIENTO	BEARING	CUSCINETTO	ROULEMENT
14	REC387247	91053-ZW1-003	RODAMIENTO AGUJAS	NEEDLE BEARING	CUSCINETTO ASSE	ROULEMENT A AIGUILLE
15	REC26-76868	91252-ZW1-003	RETEN	SEAL	TENUTA	JOINT SPI
16	REC26-70081	91351-ZW1-003	RETEN	SEAL	TENUTA	JOINT SPI
17	REC90508-ZW1-003	90508-ZW1-003	ARANDELA SEGURIDAD	WASHER TAB	RONDELLA	RONDELLE FREIN
18	REC90301-ZW1-003	90301-ZW1-003	TUERCA HELICE	NUT PROPELLER	DADO ELICHE	ÉCROU

HONDA

RECAMBIOS  
MARINOS

## COMPONENTES DE COLA

## DRIVE COMPONENTS

## COMPONENTI PIEDI

## PIECES D' EMBASES

### KITS JUNTAS Y RETENES

### SEALS KITS

### KIT GUARNIZIONE E TENUTE

### KITS JOINTS D'EMBASE

REF	OEM
REC18-8362-1	

Series 14ZV50M  
 BF35/45 AM BF40/50 A, AW, AX

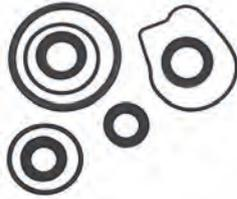

REF	OEM
REC18-8363	

 BF9.9  
BF15



REF	OEM
REC18-8365	

 BF115  
BF130

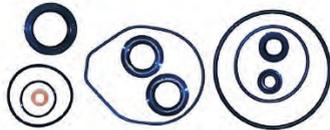

REF	OEM
REC18-8366	

 BF75  
BF90

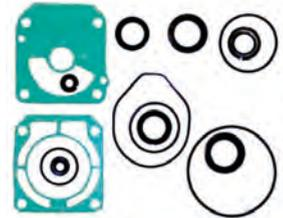

### RETENES EJE DE TRASMISION

### SEALS DRIVE SHAFT

### TENUTE ASSE DI TRASMISSIONE

### JOINTS SPI ARBRE DE TRANSMISSION

REF	OEM
REC26-43036	91254-ZW1-003

 BF75AT  
BF90AT



REF	OEM
REC26-43035	91251-ZW1-003

 BF75AT  
BF90AT



### RETENES EJE DE HÉLICE

### SEALS PROPELLER SHAFT

### TENUTE ASSE ELICA

### JOINTS SPI ARBRE D'HÉLICE

REF	OEM
REC26-76868	91252-ZW1-003

 BF75AT  
BF90AT



REF	OEM
REC26-70081	91255-ZW1-003 91351-ZW1-003

 BF75AT  
BF90AT



### RETENES EJE DE CAMBIO

### SEALS SHIFT SHAFT

### TENUTE ASSE DI CAMBIO

### JOINTS SPI ARBRE DE CHANGEMENT

REF	OEM
REC26-8164641	91253-ZW1-003

 BF75AT  
BF90AT



### JUNTA EJE SELECTOR

### O-RING DRIVE SHAFT

### GUARNIZIONE ASSE TRASMISSIONE

### JOINTS D'ARBRE DE SELECTEUR

REF	OEM
REC25-457101	91353-ZW1-003

 DF75AT  
DF90AT



**TUERCA DIÁBOLO**

**NUT, GEARCASE END**

**DADO DIAVOLO**

**ECROU DE DIABOLO**

REF	OEM
REC41109-ZV5-000	41109-ZV5-000

 BF35AM  
 BF40B, B2, BX, A4, A/ A1, A2, AX, A3, AY  
 BF45AM  
 BF50A4, A/ A1, A2,AX, A3, AY



**EJE HÉLICE**

**PROPELLER SHAFT**

**ASSE ELICA**

**ARBRE D'HELICE**

REF	OEM
REC41161-ZV5-000	41161-ZV5-000

 BF35AM  
 BF40B, B2, BX, A4, A/ A1, A2, AX, A3, AY  
 BF45AM  
 BF50A4, A/ A1, A2,AX, A3, AY



**RODAMIENTO PIÑÓN AVANTE**

**FORWARD GEAR BEARING**

**CUSCINETTO PIGNONE AVANTI**

**ROULEMENT DE PIGNON AVANT**

REF	OEM
REC31-30894A1	91051-ZW1-003

 BF75AT  
 BT90AT



REF	OEM
REC31-30895T	91057-ZW1-003

 BF75AT  
 BT90AT



**RODAMIENTO DIÁBOLO**

**CARRIER BEARING**

**CUSCINETTO DIAVOLO**

**ROULEMENT DE DIABOLO**

REF	OEM
REC387247	91053-ZW1-003

 BF75AT  
 BF90AT



**ARANDELA DE CIERRE**

**TAB WASHER**

**RONDELLA CHIUSURA**

**RONDELLE FREIN**

REF	OEM
REC90508-ZW1-003	90508-ZW1-003

 BF75AT  
 BF90AT



# SISTEMA DE PROPULSIÓN PROPULSION SYSTEM

# SISTEMA DI PROPULSIONE SYSTEME DE PROPULSION

HÉLICES ALUMINIO E INOXIDABLE DE 3 Y 4 PALAS    3 & 4 BLADE ALUMINIUM & SS PROPELLERS    ELICHE ALLUMINIO E INOX DA 3 E 4 PALE    HELICE ALUMINIUM ET INOX 3 ET 4 PALES

CÓDIGO DE REFERENCIAS    PART NO. CODING SYSTEM    SISTEMA DI CODICE    CODAGE DES REFERENCES

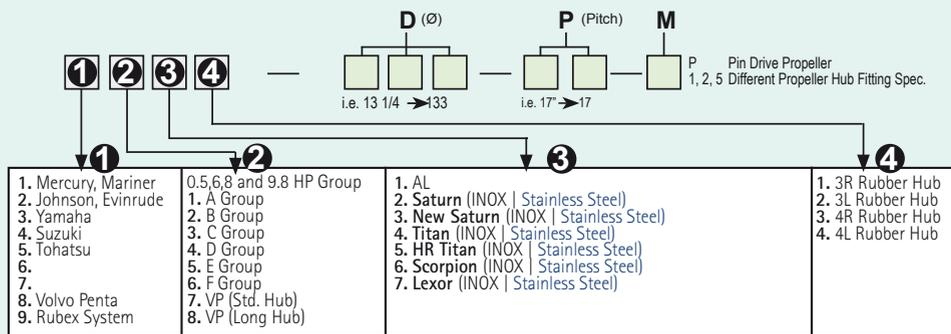

## AMITA 3



Hélice de aluminio con núcleo de goma de gran resistencia.

Aluminum propeller with heavy duty rubber hub.

Eliche di alluminio con mozzi in gomma ad alta resistenza.

Hélice en aluminium avec moyeu en caoutchouc



## AMITA 4



Hélices de aluminio con núcleo de goma de gran resistencia. Van muy suaves a poca velocidad y hace el barco muy manejable con la mar picada.

Aluminum propeller with heavy duty rubber hub. Smoother low speed makes the offshore boating activity much easier.

Eliche di alluminio con mozzo in gomma ad alta resistenza. Molto morbido a bassa velocità e rende la barca molto maneggevole con mare cattivo.

Hélice en aluminium avec moyeu en caoutchouc. Permet d'aller doucement à basse vitesse et rende le bateau très maniable lorsque la mer est agitée



## TITAN



Hélices de acero inox. Diseño de pala grande para un área más grande. Gran capacidad de transporte de carga. Excelente economía de combustible.

Stainless steel propeller. High camber blade and large blade area design. Great load carrying capability. Excellent fuel economy.

Eliche in acciaio inossidabile. Ampia capacità di carico. Eccellente riduzione consumo del carburante.

Hélice en acier inoxydable. Lame à carrossage élevé et conception à grande surface de lame. Grande capacité de charge. Excellente économie de carburant.



## NEW SATURN



Hélices de acero inoxidable. Ofrece buena aceleración y rendimiento. Tamaño más pequeño que ofrece un diámetro extragrande.

Stainless steel propeller. Offers good acceleration & all-round performance. Smaller pitch sizes offered in extra large diameter with increased blade area.

Eliche di acciaio inox. Buona accelerazione. Piccole dimensioni che offre un più grande diametro.

Hélice inox, offrant de bonnes accélérations et performances. Taille de pas réduite pour les modèles de grands diamètres avec une surface de pale plus importante.



## HR TITAN 3 PROP



Hélice de acero inoxidable. Alto rendimiento para cascos de alta velocidad. La inclinación de la hoja proporciona un excelente elevación de proa y aceleración. El diseño de copa grande aumenta la mordida y reduce el deslizamiento.

Stainless steel propeller. Performance prop for high speed planning hulls. High rake blade design provides excellent bow lift and acceleration. Heavy cup design increases bite and reduces slip.

Eliche in acciaio inox. Alte prestazioni per scafi ad alta velocità. Il passo della pala fornisce un'eccellente spinta e accelerazione. Il disegno aumenta le prestazioni.

Hélice en acier inoxydable. Hélice de performance pour les coques de planification à grande vitesse. La conception de la lame à haut râteau offre une excellente portance et accélération de l'arc. La conception lourde de la tasse augmente la morsure et réduit le glissement.



**GUÍA DE HÉLICES  
CON NÚCLEO INTEGRADO**

**PROPELLERS APPLICATION  
WITH RUBBER HUB**

**GUIDA ELICHE  
CON MOZZO**

**GUIDE DES HELICES ET  
MOYEURS**

	R.O. OEM	A	B	D	P	R	AL		INOX STAINLESS STEEL				
							AMITA 3	AMITA 4	NEW SATURN	TITAN	HR TITAN 3		
BF2 Series	58130-ZV0-841ZB			3	7 <sup>1/4</sup>	6	R	Plastic	SOL6001-073-06P				
BF4				3	7 <sup>7/8</sup>	6 <sup>3/4</sup>	R		SOL6011-079-06P				
BF5						7 <sup>1/2</sup>			SOL6011-079-07P				
					9 <sup>1/4</sup>	7			SOL3111-093-07				
8 (2001+)	58130-ZV4-703ZB				9 <sup>1/2</sup>	8 <sup>5/8</sup>			SOL3111-093-08				
9.9 (1988+)	58130-ZV4-030ZB	8	3		9 <sup>1/2</sup>	9 <sup>1/2</sup>	R		SOL3111-093-09				
15 (1988+)					9 <sup>1/4</sup>	10			SOL3111-093-10				
20 (2003+)					9 <sup>1/4</sup>	11			SOL3111-093-11				
	58130-ZV7-850ZA				9 <sup>3/4</sup>	9 <sup>7/8</sup>			SOL5211-099-09				
									SOL5211-099-10				
25	58130-ZV7-000ZA	10	3		9 <sup>1/4</sup>	12	R		SOL5211-099-11				
30									SOL5211-099-12				
									SOL5211-099-13				
	58130-ZV5-860ZA				11 <sup>3/4</sup>	10			SOL3311-121-09				
									SOL3311-116-11				
35 (1991+)	58130-ZV5-850ZA				11 <sup>1/2</sup>	12			SOL3311-114-12				
40 (1995+)	58130-ZV5-000ZA				11 <sup>1/4</sup>	13			SOL3311-111-13				
45 (1991-94)	58130-ZV5-870ZA	13	3		11 <sup>1/2</sup>	14	R		SOL3311-111-14				
BF40EFI									SOL3311-110-15				
BF50EFI									SOL3311-110-16				
BF60EFI					11	16			SOL3311-110-17				
50 (1995+)					11	17			SOL3311-110-17				
	58130-ZW1-W01ZA				14	11	R		SOL6411-140-11		SOL6431-140-11		
	58130-ZW1-W11ZA				13.75-13.25	13	R		SOL6411-138-13	SOL6413-133-13	SOL6431-138-13		
					13.5	14	R		SOL6411-135-14				
					13.5-13	15	R		SOL6411-135-15	SOL6413-130-15	SOL6431-135-15		
	58130-ZW1-W31ZA				13.5	15	L		SOL6412-135-15				
					13.25-12.75	17	R		SOL6411-133-17	SOL6413-128-17	SOL6431-133-17		
75 (1995+)	58130-ZW1-W61ZA				13.25	17	L		SOL6412-133-17				
90 (1995+)	58130-ZW1-W41ZA	15	3		13-12.5	19	R		SOL6411-130-19	SOL6413-125-19	SOL6431-130-19		
115 (1998-09)					13-12.5	21	R		SOL6411-130-21	SOL6413-125-21	SOL6431-130-21		
130 (1998-09)													
BFP60A	08M60-ZW7-A40				14 <sup>1/2</sup>	15	R				SOL1531-145-15		
					14 <sup>1/4</sup>	17	R				SOL1531-143-17		
	08M60-ZW7-A00				14	19	R				SOL1531-140-19		
	08M60-ZW7-A10				14	21	R				SOL1531-140-21		
	08M60-ZW7-A20				14	23	R				SOL1531-140-23		
	08M60-ZW7-A30				14	25	R				SOL1531-140-25		
					15-14.75	15	R		SOL1511-150-15	SOL1513-148-15			
					15	15	L		SOL1512-150-15		SOL1532-145-15		
					14.8-14.5	17	R		SOL1511-148-17	SOL1513-145-17			
					14.8	17	L		SOL1512-148-17		SOL1532-143-17		
					14.5-14.25	19	R		SOL1511-145-19	SOL1513-143-19			
					14.5	19	L		SOL1512-145-19		SOL1532-140-19		
					14	21	R			SOL1513-140-21			
					14	23	R			SOL1513-140-23			
					14.3	21	R		SOL1511-143-21				
115 (2010+)					14.3	21	L		SOL1512-143-21		SOL1532-140-21		
130 (2010+)					14.2	23	R		SOL1511-142-23				
135 (2004+)					14.2	23	R		SOL1511-142-23				
150 (2004+)		15	3		14.2	23	L		SOL1512-142-23		SOL1532-140-23		
200 (2002+)					15 <sup>1/2</sup> -15 <sup>3/4</sup>	15	R				SOL1571-158-15		
225 (2002+)					15 <sup>1/2</sup> -15 <sup>3/4</sup>	15	L				SOL1542-155-15	SOL1572-158-15	
250 (2012+)					15 <sup>1/4</sup> -15 <sup>1/2</sup>	17	R				SOL1571-155-17		
					15 <sup>1/4</sup> -15 <sup>1/2</sup>	17	L				SOL1572-155-17		
					15-15 <sup>1/4</sup>	19	R				SOL1571-153-19		
					15-15 <sup>1/4</sup>	19	L				SOL1572-153-19		
					14 <sup>3/4</sup> -15	21	R				SOL1542-150-19	SOL1572-153-19	
					14 <sup>3/4</sup> -15	21	L				SOL1571-150-21	SOL1572-150-21	
					14 <sup>1/2</sup> -14 <sup>3/4</sup>	23	R				SOL1572-150-21	SOL1571-148-23	
					14 <sup>1/2</sup> -14 <sup>3/4</sup>	23	L				SOL1572-148-23		
					14 <sup>1/2</sup>	25	R				SOL1571-145-25		

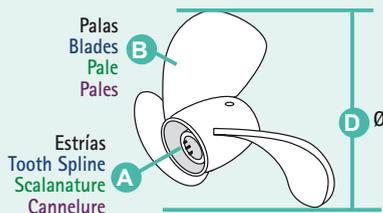

- P** Paso  
Pitch  
Paso  
Pas  
**R** Rotación L (izquierda) R (derecha)  
 Rotation L (left) R (Right)  
 Rotazione L (SX) R (DX)  
 Rotation L (gauche) R (droit)

**NÚCLEO INTERCAMBIABLE INTERCHANGEABLE HUB**

**MOZZO INTERCAMBIABILE MOYEU INTERCHANGEABLE**

	A	REF	
BF 35/45 (1991-94)	13	SOLRBX-113	C
BF 40/50/50A (1995+)	13	SOLRBX-102	D
75-90 HP (1995-98)	13	SOLRBX-107	D
75-90 HP (1999+)	13	SOLRBX-107	D
115-130HP (1998+)	15	SOLRBX-107	D
115-130HP (1998+)	15	SOLRBX-107	E
BF135, 150, 200, 225HP (2003+)	15	SOLRBX-107	E
BF250			



**RUBEX**

**HÉLICES PARA NÚCLEO INTERCAMBIABLE**

**PROPELLERS FOR INTERCHANGEABLE HUB**

**ELICHE PER MOZZO INTERCAMBIABILE**

**HELICES AVEC MOYEU INTERCHANGEABLE**

	B	D	P	R	AL
<b>C</b> 30-75 HP	3	12.1	9	R	SOL9311-121-09
		12	10	R	SOL9311-120-10
		11.6	11	R	SOL9311-116-11
		11.4	12	R	SOL9311-114-12
		11.1	13	R	SOL9311-111-13
		11.1	14	R	SOL9311-111-14
		11	15	R	SOL9311-110-15
<b>D</b> 40-140 HP	3	14	9	R	SOL9411-140-09
		14	11	R	SOL9411-140-11
		13.75	13	R	SOL9411-138-13
		13.50	15	R	SOL9411-135-15
		13.25	17	R	SOL9411-133-17
		13.2	19	R	SOL9411-132-19
		13.2	21	R	SOL9411-132-21
<b>E</b> 135-350 HP	3	15.5	11	R	SOL9511-155-11
		15.3	13	R	SOL9511-153-13
		16	13	R	SOL9511-160-13
		15	15	R	SOL9511-150-15
		15	15	L	SOL9512-150-15
		14.8	17	R	SOL9511-148-17
		14.8	17	L	SOL9512-148-17
		14.5	19	R	SOL9511-145-19
		14.5	19	L	SOL9512-145-19
		14.3	21	R	SOL9511-143-21
14.3	21	L	SOL9512-143-21		

	B	D	P	R	INOX STAINLESS STEEL
<b>C</b> 30-75 HP	3	11 5/8	11	R	SOL9331-116-11
		11 3/8	12	R	SOL9331-114-12
		11 1/8	13	R	SOL9331-111-13
		11 1/8	14	R	SOL9331-111-14
		11	15	R	SOL9331-110-15
				13 3/4	13
<b>D</b> 40-140 HP	3	13 3/4	13	L	SOL9432-138-13
		13 1/2	15	R	SOL9431-135-15
		13 1/2	15	L	SOL9432-135-15
		13 1/4	17	R	SOL9431-133-17
		13 1/4	17	L	SOL9432-133-17
		13	19	R	SOL9431-130-19
<b>E</b> 90-140 HP	3	13	19	L	SOL9432-130-19
		13	21	R	SOL9431-130-21
		14 1/2	15	R	SOL9531-145-15
		14 1/2	15	L	SOL9532-145-15
		14 1/4	17	R	SOL9531-143-17
		14 1/4	17	L	SOL9532-143-17
		14	19	R	SOL9531-140-19
		14	19	L	SOL9532-140-19
		14	21	R	SOL9531-140-21
		14	21	L	SOL9532-140-21
<b>E</b> 135-350 HP	3	14	23	R	SOL9531-140-23
		14	23	L	SOL9532-140-23
		15 3/4	15	R	SOL9571-158-15
		15 3/4	15	L	SOL9572-158-15
		15 1/2	17	R	SOL9571-155-17
		15 1/2	17	L	SOL9572-155-17
		15 1/4	19	R	SOL9571-153-19
		15 1/4	19	L	SOL9572-153-19
		15	21	R	SOL9571-150-21
		15	21	L	SOL9572-150-21
<b>E</b> 135-350 HP	3	14 3/4	23	R	SOL9571-148-23
		14 3/4	23	L	SOL9572-148-23
		14 1/2	25	R	SOL9571-145-25
		14 1/2	25	L	SOL9572-145-25

**RUBEX**



Núcleo intercambiable (no incluido).  
Interchangeable hub (not included).  
Mozzo intercambiabile (non incluso).  
Moyeu interchangeable (non inclus)





# REF--> RO / OEM

REF	R.O. / OEM	
<b>C</b>		
CEF500301	19210-ZW1-303	568
CEF500328	19210-ZV4-013	568
CEF500337	19210-ZW1-B04	568
CEF500338	19210-ZV5-003	568
CEF500339	19210-ZV7-003	568
CEF500343	19210-ZV4-651	568
CEF500347	19210-ZW9-013	568
CEF500348	19210-ZW9-A32	568
CEF500391	19210-ZY3-003	568
CM06411-ZV5-000	06411-ZV5-000	571
CM06411-ZV5-000	06411-ZV5-020	571
CM06411-ZV5-000A	06411-ZV5-000	571
CM06411-ZV5-000A	06411-ZV5-020	571
CM06411-ZW1-000	06411-ZW1-000	571
CM06411-ZW1-000	06411-ZW1-020	571
CM06411-ZW1-000A	06411-ZW1-000	571
CM06411-ZW1-000A	06411-ZW1-020	571
CM31640	06412-ZV1-000	572
CM31640	41107ZV1003	572
CM31640A	06412-ZV1-000	572
CM31640A	41107ZV1003	572
CM41106-ZW9-000A	41106-ZW9-000	572
CM41106-ZW9-000A	41106ZW909000	572
CM41106-ZW9-09000	41106-ZW9-000	572
CM41106-ZW9-09000	41106ZW909000	572
CM41106-ZW9-09000	41106-ZW9-090	545
CM41107-ZV500	06412-ZV5-000	572
CM41107-ZV500	41107ZV500	572
CM41107-ZV500A	06412-ZV5-000	572
CM41107-ZV500A	41107ZV500	572
CM41107-ZV500A	41107-ZV5-000	545
CM41107-ZW1-B01	41107ZV1-B01	572
CM41107-ZW1-B01A	41107ZV1-B01	572
CM41109-ZW1-B00	41109-ZW1-B00	571
CM41109-ZW1-B00A	41109-ZW1-B00	571
CM664-45371-01	06412-ZV5-000	572
CM664-45371-01A	06412-ZV5-000	572
CM6E0-45251-11	2155-ZV5-000	572
CM6E0-45251-11A	2155-ZV5-000	572
CM826134	12155-ZV5-000	571
CM826134	41109-ZW1-003	571
CM826134A	12155-ZV5-000	571
CM826134A	41109-ZW1-003	571
CMHBF35225KITA		546-572
CMHBF35225KITM		572
CMHBF4050KITA		545-546-572
CMHBF4050KITM		572
CMHBF75115KITA		546-572
CMHBF75115KITM		572
CHACJ14		559
CHAP10Y		559
CHAP8Y		559
CHAPROSU		559
CHARA6HC		559
CHARA8HC		559
CHARC9MC4		559
CHARN11YC4		559
<b>G</b>		
GS11290		561
GS11291		561
GS11292		561
GS11294		561
GS30435		552
GS31001		552
GS31002		552
GS31030	17660-ZV5-902	548
GS31031	17660-ZV5-A00	548
GS31031	17660-ZW9-003	548
GS31032	116977-ZV5-900	549
GS31033	116977-ZV5-A00	549
GS31034	17650-921-003ZB	548
GS31064		549
GS31065		552
GS31066		552
GS31067		552
GS31068		548
GS31069		548
GS31090		547
GS31095		547
GS31096		547
GS31097		547
GS31099		547
GS31155		552
GS31156		552
GS31157		552
GS31166		552
GS31183		547
GS31187		547
GS31189		547
GS35031		547
GS35032		547
<b>L</b>		
LENS3213	17670-ZW1-801AH	550-551
LENS3227		550
LENS3240	17670-ZW1-030GH	551
<b>N</b>		
NGKBMR4A		559
NGKBPR5ES	98079-55846	545-559
NGKCR5EH-9	98059-55916	545-559
NGKCR5HSB		559
NGKDR4HS		559

REF	R.O. / OEM	
NGKDR5HS	98066-55716	559
NGKDR6HS		545-559
NGKDR7EA	98069-5771P	545-546-559
NGKDR7EB	98069-5777P	546
NGKIZFR6K-11E	31916-ZY2-003	559
NGKIZFR6K11	31916-ZY3-003	546-559
NGKLMAR6C-9	31908-ZZ3-003	546-559
NGKZFR7F		546-559
<b>P</b>		
PAF15-04000003	90507-921-000	545-546
PAF15-07000031	19300-881-741	566
PAF15-07000031	19300-921-003	566
PAF15-07000031	19300-ZW9-003	566
PAF15-07000031	19300-ZW9-003	545-546-566-567
PAF4-04000030		548
PAF4-05000010		548
PAF40-0701000EI		550
PAGB/T91-2.5X30	90758-ZV1-000	545-546
PH130-0054	31200-ZV5-003	560
PH130-0054	31200-ZV5-013	560
PH130-0064	31200-ZW1-004	560
PH130-0065	31200-ZW5-003	560
PH130-0070	31200-ZY3-003	560
PH130-0070	31200-ZY3A-00304	560
PH200-T021	36120-ZV5-821	562
PH200-T046	36120-ZV5-822	562
PH200-WH01		562
PRE3300C05	24911-ZW7-U01	565
PRE3300C06	24912-ZW7-U01	565
PRE3300C07	24913-ZW7-U01	565
PRE3300C08	24914-ZW7-U01	565
PRE3300C09	24915-ZW7-U01	565
PRE3300C10	24916-ZW7-U01	565
PRE3300C11	24917-ZW7-U01	565
PRE3300C12	24918-ZW7-U01	565
PRE3300C13	24919-ZW7-U01	565
PRE3300C14	24920-ZW7-U01	565
PRE3300C15	24921-ZW7-U01	565
PRE3300C16	24922-ZW7-U01	565
PRE3300C17	24923-ZW7-U01	565
PRE3300C18	24924-ZW7-U01	565
PRE3300C19	24925-ZW7-U01	565
PRE3300C20	24926-ZW7-U01	565
PRE3300C21	24927-ZW7-U01	565
PRE3300C22	24928-ZW7-U01	565
PRE3300C23	24929-ZW7-U01	565
PRE3300C24	24930-ZW7-U01	565
PRE3300C25	24931-ZW7-U01	565
PRE3300C26	24932-ZW7-U01	565
PRE3300C27	24933-ZW7-U01	565
PRE3300C28	24934-ZW7-U01	565
PRE3300C29	24935-ZW7-U01	565
PRE3300C30	24936-ZW7-U01	565
PRE3300C31	24937-ZW7-U01	565
PRE3300C32	24938-ZW7-U01	565
<b>R</b>		
RAC025-RAC-02	06176-ZW3-801AH	553
RAC120R-RAC-01	06178-ZW1-030GH	551
RAC23289-10		550
RAC23299-10		550
RAC320R-INOX-01	06177-ZW1-801AH	551
RAC320R-INOX-02		551
RAC320R-RAC-01		550-551
RAC320R-RAC-02		551
RAC320R-RAC-03	06177-ZW1-801AH	550-551
RAC490R-RAC-01		550
RACPF5510		549
RACRK22628		552
RACS2502	17670-ZW3-801AH	553
RACS3213	17670-ZW1-801AH	550-551
RACS3220UL		551
RACS3227		550
RACS3240	17670-ZW1-030GH	551
REC004		559
REC06160-ZV4-U11	06160-ZV4-U11	556
REC06164-PCA-000	16450-ZY6-003	555
REC06192-881-C00	06192-881-C00	570
REC06192-ZV1-000	06192-ZW1-000	546-571
REC06192-ZV1-000	06192-ZV1-000	571
REC06192-ZV1-305	06192-ZV1-305	546-571
REC06192-ZV1-305	06192-ZW1-305	571
REC06192-ZV1-C00	06192-ZV1-C00	545-570
REC06192-ZV4-000	06192-ZV4-000	545-571
REC06192-ZV4-000	19210-ZV4-651	571
REC06192-ZV5-003	06192-ZV5-003	545-546-571
REC06192-ZV7-000	06192-ZV7-000	545-571
REC06192-ZW9-A30	06192-ZW9-A30	545-570
REC06192-ZY3-000	06192-ZX2-000	571
REC06192-ZY3-000	06192-ZY3-000	571
REC06192-ZY3-000	06192-ZY3-000	546
REC06192-ZY6-000	06192-ZY6-000	546-571
REC06193-ZV5-020	06193-ZV5-000	570
REC06193-ZV5-020	06193-ZV5-010	570
REC06193-ZV5-020	06193-ZV5-020	570
REC06211-ZV1-505	06211-ZV1-505	545
REC06211-ZV4-505	06211-ZV4-505	545
REC06211-ZV5-505	06211-ZV5-505	545
REC06211-ZV7-505	06211-ZV7-505	545
REC06211-ZW0-505	06211-ZW0-505	546
REC06211-ZW5-505	06211-ZW5-505	546
REC06211-ZW9-505	06211-ZW9-505	545

REF	R.O. / OEM	
REC06211-ZY0-505	06211-ZY0-505	545
REC06211-ZY2-506	06211-ZY2-506	546
REC06211-ZY5-505	06211-ZY5-505	546
REC06211-ZY9-505	06211-ZY9-505	546
REC06211-ZZ3-506	06211-ZZ3-506	546
REC06211-ZZ5-505	06211-ZZ5-505	546
REC06240-ZW5-U40	06240-ZW5-U40	564
REC06240-ZW5-U40	06240-ZW5-U001	564
REC06240-ZW5-U60	06240-ZW5-U60	564
REC09401-11425		548
REC09401-11425		548
REC09401-11425BULK		548
REC09401-11425BULK		548
REC10W30U3	08207-10W30MFC-W	553
REC10W30U6	08209-10W30MFC-W	553
REC10W40U3		553
REC10W40U6		553
REC12-191833	12-191833	545-546-575
REC12209-6B4-681	12209-GB4-681	576
REC12251-ZV5-003	12251-ZW4-H01	574
REC12251-ZV5-003	12251-ZV5-000	574
REC12251-ZV5-003	12251-ZV5-003	574
REC12251-ZV7-004	12251-ZV7-004	574
REC12251-ZW1-014	12251-ZW1-004	574
REC12251-ZW1-014	12251-ZW1-014	574
REC12251-ZW5-023	12251-ZW5-003	574
REC12251-ZW5-023	12251-ZW5-013	574
REC12251-ZW5-023	12251-ZW5-023	574
REC14400-ZV5-014	14400-ZV5-004	575
REC14400-ZZ3-004	14400-ZZ3-004	575
REC15112-ZW5-003	15112-ZW5-003	574
REC15400-PLM-A01PE	15400-PH1-F03	554
REC15400-PLM-A01PE	15400-PLM-A01PE	554
REC15400-PLM-A01PE	15400-POH-305	554
REC15400-PLM-A01PE	15400-POH-305PE	554
REC15400-PLM-A01PE	15400-RTA-004	554
REC15400-PLM-A01PE	15400-RTA-004	554
REC15400-PLM-A01PE	15400-ZJ1-004	546-554
REC15400-RBA-F01	15400-RBA-F01	546-554
REC16010-ST5-993	16900-ST5-993	553
REC16010-ZV4-005	06160-ZV4-U11	556
REC16010-ZV4-005	16010-ZV4-005	556
REC16010-ZV4-005	16010-ZV4-005	556
REC16010-ZV4-005	16010-ZV4-005	556
REC16010-ZW9-003	16010-ZW9-003	556
REC16011-881-741	16011-881-741	555
REC16011-ZV4-005	16011-ZV4-005	555
REC16201-881-850	16201-881-850	576
REC16221-ZV4-610	16221-ZV4-610	576
REC16221-ZW1-000	16221-ZW1-000	576
REC16221-ZW9-000	16221-ZW9-000	576
REC16735-ZW5-003	16735-ZW5-003	555
REC16735-ZW5-003	16735-ZY3-004	555
REC16900-SA5-004	16900-SA5-004	545-546-552
REC16900-SR3-004	16900-SR3-004	546-552
REC16901-ZY3-003	16901-ZY3-003	553
REC16901-ZY3-003	16911-ZY3-003	553
REC16910-GB2-005	16900-GB2-005	545-552
REC16910-ZV4-015		

REF	R.O. / OEM	
REC19300-ZV5-043	19300-ZV5-013	566
REC19300-ZV5-043	19300-ZV5-023	566
REC19300-ZV5-043	19300-ZV5-033	566
REC19300-ZV5-043	19300-ZV5-043	566
REC19300-ZV5-043	19300-ZV5-043	546-566-567
REC22-8M0001721		548
REC23172-ZW1-013	23172-ZW1-013	574
REC23172-ZW5-013	23172-ZW5-013	574
REC24800-ZZ5-A02	24800-ZZ5-A01	564
REC24800-ZZ5-A02	24800-ZZ5-A02	564
REC24800-ZZ5-A02	24800-ZZ5-A22	564
REC24942	06177-ZX2-000HE	549
REC24950		549
REC24952	06177-ZX2-000HE	549
REC25-457101	91353-ZW1-003	577
REC25-457101	91353-ZW1-003	578
REC25000		549
REC25010		549
REC25020		549
REC25030		549
REC25W40U3		553
REC26-43035	91251-ZW1-003	577-578
REC26-43036	91254-ZW1-003	577-578
REC26-70081	91255-ZW1-003	578
REC26-70081	91351-ZW1-003	577-578
REC26-76868	91252-ZW1-003	577-578
REC26-8164641	91253-ZW1-003	577-578
REC27-430331	19234-ZW1-003	569-577
REC27-430472	19242-ZW1-003	570-577
REC27-8172771	19232-ZW1-003	570-577
REC2TU3		553
REC2TU6		553
REC30520-PNA-007	30520-PNA-007	559
REC30520-PWC-003	30520-PWC-S01	559
REC30530-P8F-A01	30530-P8F-A01	558
REC30530-PNA-003	30530-PNA-003	558
REC30530-RNA-A01	30530-RNA-A01	558
REC30580-ZV4-013	30580-ZV4-023	559
REC31-30894A1	91051-ZW1-003	577-579
REC31-30895T	91057-ZW1-003	577-579
REC31200-ZW9-802	31200-ZW9-801	560
REC31200-ZW9-802	31200-ZW9-802	560
REC31200-ZY6-003	31200-ZY6-003	560
REC31200-ZY6-003	31200-ZY9-003	560
REC31200-ZY6-003	31200-ZY9A-0031	560
REC31630-ZW5-003	31630-ZW5-003	561
REC31630-ZY3-003	31630-ZY3-003	561
REC31630-ZY6-003	31630-ZY6-003	561
REC31630-ZY6-003	31630-ZY6-013	561
REC31638-ZY3-003	31638-ZY3-003	561-562
REC31638-ZY6-003	31638-ZY6-003	561-562
REC35-802893Q		549
REC35-802893Q01		549
REC35-822626Q03	15400-PFB-004	554
REC35-822626Q03	15400-PFB-014	554
REC35-822626Q03	15400-PFRB-007	554
REC35-822626Q03	15400-PJ7-015	554
REC35-822626Q03	15400-PM3-004	554
REC35-822626Q03	15400-PM3-405	554
REC35-822626Q03	15400-ZW4-003	554
REC35-822626Q03	15400-ZW4-003	545-546-554
REC35100-ZV5-013	35100-ZV5-013	565
REC35655-ZY3-013	35655-ZY3-013	558
REC35655-ZY9-003	35655-ZY9-003	558
REC35668-ZY6-003	35668-ZY6-003	558
REC36120-ZW4-H12	36120-ZW4-H12	562
REC36120-ZY6-013	36120-ZY6-013	563
REC36120-ZY6-013	36120-ZY6-023	563
REC36120-ZY9-003	36120-ZY9-003	563
REC36120-ZY9-003	36120-ZY9-013	563
REC37260-RNA-A01	37260-RNA-A01	558
REC37500-PNB-003	37500-PNB-003	557
REC37510-PNB-003	37510-PNB-003	557
REC37830-PGK-A01	37830-PGK-A01	557
REC37830-PNC-003	37830-PNC-003	557
REC37830-RNA-A01	37830-RNA-A01	557
REC37840-R70-A01	37840-R70-A01	557
REC37880-PLC-004	37880-PLC-004	558
REC387247	91053-ZW1-003	577-579
REC40135		552
REC40145		552
REC40155		552
REC40165		552
REC40970		561
REC40990		561
REC41109-ZV5-000	41109-ZV5-000	579
REC41161-ZV5-000	41161-ZV5-000	579
REC47-43026Q02	19120-ZW1-303	577
REC47-43026Q02	19210-ZW1-303	567
REC47-43026Q02	19210-ZW1-303	568
REC47-43026Q06	19021-ZW1-003	571-577
REC5GH-13440-00	15400-PFB-007	554
REC5W40U3	08207-5W30M2	553
REC5W40U6		553
REC650-24351-51		548
REC67F-12411-01	19300-ZX2-003	566-567
REC6AH-12411-00	19300-ZY3-023	566-567
REC6E5-12411-30	19300-ZY6-003	566-567
REC6E5-24351-51		548
REC70720		552
REC80W90U3	08739-90W	553
REC80W90U6		553

REF	R.O. / OEM	
REC8172761	19231-ZW1-003	569-577
REC855686		549
REC90301-ZW1-003	90301-ZW1-003	577
REC90508-ZW1-003	90508-ZW1-003	577-579
REC90752-ZV4-650	90752-ZV4-650	569
REC90752-ZV5-003	90752-ZV5-003	546-569
REC90752-ZV7-000	90752-ZV7-000	569
REC90752-ZW1-B02	90752-ZW1-003	577
REC90752-ZW1-B02	90752-ZW1-B02	569
REC90752-ZY3-003	90752-ZY3-003	569
REC90794-46866		551
REC90794-46868		551
REC91252-935-004	91252-935-004	570
REC91252-ZV1-003	91252-ZV1-003	570
RECOBRACKET		549
RECOBLEMENT		550
RECOFILALU		550
RECOFILTER		550
RECPIN4		563
RECPIN4.5		563
RECPIN6		563
RECTOOLTRIM1		563
RECTOOLTRIM2		563
RECTOOLTRIM3		563
RECTOOLTRIMKIT		563
RECYL-225-15		551
RM06111-ZW1-020	06111-ZW1-000	575
RM061A1-ZV0-000	061A1-ZV0-000	575
RM14400-921-024	14400-921-010	575
RM14400-921-024	14400-921-024	575
RM14400-ZV4-004	14400-ZV4-004	575
RM14400-ZW1-004	14400-ZW1-004	575
RM19211-ZV0-003	19211-ZV0-003	568
RM35-802893Q		549
RM92-858026QB1U6		553
RM92-858027QB1U3		553
RM92-8M0086220U6		553
RM92-8M0086221U3		553
<b>S</b>		
SIE18-8013		547
SIE18-8015		547
SOL1511-142-23	58233-ZY3-A23H	581
SOL1511-143-21	58233-ZY3-A21H	581
SOL1511-145-19	58233-ZY3-A19H	581
SOL1511-148-17	58233-ZY3-A17H	581
SOL1511-150-15	58233-ZY3-A15H	581
SOL1512-142-23		581
SOL1512-143-21		581
SOL1512-145-19		581
SOL1512-148-17		581
SOL1512-150-15		581
SOL1513-140-21	58233-ZY3-A21H	581
SOL1513-140-23	58233-ZY3-A23H	581
SOL1513-143-19	58233-ZY3-A19H	581
SOL1513-145-17	58233-ZY3-A17H	581
SOL1513-148-15	58233-ZY3-A15H	581
SOL1531-140-19	08M60-ZW7-A00	581
SOL1531-140-21	08M60-ZW7-A10	581
SOL1531-140-23	08M60-ZW7-A20	581
SOL1531-140-25	08M60-ZW7-A30	581
SOL1531-143-17	58233-ZY3-A17H	581
SOL1531-145-15	08M60-ZW7-A40	581
SOL1532-140-19	58233-ZY3-B19H	581
SOL1532-140-21		581
SOL1532-143-17	58233-ZY3-B17H	581
SOL1532-145-15	58233-ZY3-B15H	581
SOL1542-150-19		581
SOL1542-155-15		581
SOL1571-145-25		581
SOL1571-148-23		581
SOL1571-150-21		581
SOL1571-153-19		581
SOL1571-155-17		581
SOL1571-158-15		581
SOL1572-148-23		581
SOL1572-150-21		581
SOL1572-153-19		581
SOL1572-155-17		581
SOL1572-158-15		581
SOL3111-093-07		581
SOL3111-093-08		581
SOL3111-093-09	58130-ZV4-703ZB	581
SOL3111-093-10	58130-ZV4-030ZB	581
SOL3111-093-11		581
SOL3111-110-15		581
SOL3111-110-16		581
SOL3111-110-17		581
SOL3111-111-13	58130-ZV5-000ZA	581
SOL3111-111-14	58130-ZV5-870ZA	581
SOL3111-114-12	58130-ZV5-850ZA	581
SOL3111-116-11		581
SOL3111-121-09	58130-ZV5-860ZA	581
SOL5211-099-09	58130-ZV7-850ZA	581
SOL5211-099-10		581
SOL5211-099-11	58130-ZV7-000ZA	581
SOL5211-099-12		581
SOL5211-099-13		581
SOL6001-073-06P	58130-ZV0-841ZB	581
SOL6011-079-06P		581
SOL6011-079-07P		581
SOL6411-130-19	58130-ZW1-W41ZA	581
SOL6411-130-21	58130-ZW1-W41ZA	581

REF	R.O. / OEM	
SOL6411-133-17	58130-ZW1-W31ZA	581
SOL6411-135-14		581
SOL6411-135-15	58130-ZW1-W21ZA	581
SOL6411-138-13	58130-ZW1-W11ZA	581
SOL6411-140-11	58130-ZW1-W01ZA	581
SOL6412-133-17	58130-ZW1-W61ZA	581
SOL6412-135-15	58130-ZW1-W31ZA	581
SOL6413-125-19	58130-ZW1-W41ZA	581
SOL6413-125-21	58130-ZW1-W41ZA	581
SOL6413-128-17	58130-ZW1-W31ZA	581
SOL6413-130-15	58130-ZW1-W21ZA	581
SOL6413-133-13	58130-ZW1-W11ZA	581
SOL6413-130-19	58130-ZW1-W41ZA	581
SOL6413-133-17	58130-ZW1-W31ZA	581
SOL6413-130-21	58130-ZW1-W41ZA	581
SOL6413-133-17	58130-ZW1-W31ZA	581
SOL6431-135-15	58130-ZW1-W21ZA	581
SOL6431-138-13	58130-ZW1-W11ZA	581
SOL6431-140-11	58130-ZW1-W01ZA	581
SOL9311-110-15		582
SOL9311-111-13		582
SOL9311-111-14		582
SOL9311-114-12		582
SOL9311-116-11		582
SOL9311-120-10		582
SOL9311-121-09		582
SOL9331-110-15		582
SOL9331-111-13		582
SOL9331-111-14		582
SOL9331-114-12		582
SOL9331-116-11		582
SOL9331-114-12		582
SOL9331-116-11		582
SOL9411-132-19		582
SOL9411-132-21		582
SOL9411-133-17		582
SOL9411-135-15		582
SOL9411-138-13		582
SOL9411-140-09		582
SOL9411-140-11		582
SOL9431-130-19		582
SOL9431-130-21		582
SOL9431-133-17		582
SOL9431-135-15		582
SOL9431-138-13		582
SOL9432-130-19		582
SOL9432-133-17		582
SOL9432-135-15		582
SOL9432-138-13		582
SOL9511-143-21		582
SOL9511-145-19		582
SOL9511-148-17		582
SOL9511-150-15		582
SOL9511-153-13		582
SOL9511-155-11		582
SOL9511-160-13		582
SOL9531-140-19		582
SOL9531-140-21		582
SOL9531-140-23		582
SOL9531-143-17		582
SOL9531-145-15		582
SOL9532-140-19		582
SOL9532-140-21		582
SOL9532-140-23		582
SOL9532-143-17		582
SOL9532-145-15		582
SOL9571-145-25		582
SOL9571-148-23		582
SOL9571-150-21		582
SOL9571-153-19		582
SOL9571-155-17		582
SOL9571-158-15		582
SOL9572-145-25		582
SOL9572-148-23		582
SOL9572-150-21		582
SOL9572-153-19		582
SOL9572-155-17		582
SOL9572-158-15		582
SOLRBX-102		582
SOLRBX-107		582
SOLRBX-113		582
TEN01400	41106-ZW-000	573
TEN01401	41106-935-812	573
TEN01402	41106-ZV4-650	545-573
TEN01403	41107-ZV5-000	573
TEN01404	06411-ZV5-000	573
TEN01404	06411-ZV5-020	573
TEN01405	06411-ZV1-000	573
TEN01406	06411-ZV1-000	573
TEN01407	41109-ZW1-B00	573
TEN01408	12155-ZV4-A00	573
TEN01408/1	12155-ZV5-000	545-573
TEN01409	41106-ZW9-000	573
TEN01410	41107-ZW1-B01ZA	573
TEN01411	41107-ZV1-003-ZA	573
TEN01412	06412-ZV5-000	573

# RO / OEM --> REF

R.O. / OEM	REF		R.O. / OEM	REF		R.O. / OEM	REF	
06111-ZW1-000	RM06111-ZW1-020	575	12251-ZW4-H01	REC12251-ZV5-003	574	19210-ZW9-013	CEF500347	568
06111-ZW1-020	RM06111-ZW1-020	575	12251-ZW5-003	REC12251-ZW5-023	574	19210-ZW9-013	REC19210-ZW9-013	545-567-568
06160-ZV4-U11	REC06160-ZV4-U11	556	12251-ZW5-013	REC12251-ZW5-023	574	19210-ZW9-A31	REC19210-ZW9-A32	568
06160-ZV4-U11	REC16010-ZV4-005	556	12251-ZW5-023	REC12251-ZW5-023	574	19210-ZW9-A32	CEF500348	568
06176-ZW3-801AH	RAC025-RAC-02	553	14400-921-010	RM14400-921-024	575	19210-ZW9-A32	REC19210-ZW9-A32	568
06177-ZW1-801AH	RAC320R-INOX-01	551	14400-921-024	RM14400-921-024	575	19210-ZY3-003	CEF500391	568
06177-ZW1-801AH	RAC320R-RAC-03	550-551	14400-ZV4-004	RM14400-ZV4-004	575	19210-ZY3-003	REC19210-ZY3-003	568
06177-ZX2-000HE	REC24942	549	14400-ZV5-004	REC14400-ZV5-014	575	19210-ZY9-H01	REC19233-ZV5-H01	567-568
06177-ZX2-000HE	REC24952	549	14400-ZW1-004	RM14400-ZW1-004	575	19211-ZV0-003	RM19211-ZV0-003	568
06178-ZW1-030GH	RAC120R-RAC-01	551	14400-ZZ3-004	REC14400-ZZ3-004	575	19231-ZW1-003	REC8172761	569-577
06192-881-C00	REC06192-881-C00	570	15112-ZW5-003	REC15112-ZW5-003	574	19232-881-850	REC19232-881-850	569
06192-ZV1-305	REC06192-ZV1-305	546-571	15400-PFB-004	REC35-822626Q03	554	19232-ZV1-A10	REC19232-ZV1-A10	569
06192-ZV1-000	REC06192-ZV1-C00	570	15400-PFB-007	REC5GH-13440-00	554	19232-ZV4-610	REC19232-ZV4-610	570
06192-ZV1-000	REC06192-ZV1-000	571	15400-PFB-014	REC35-822626Q03	554	19232-ZW1-003	REC27-8172771	570-577
06192-ZV1-C00	REC06192-ZV1-C00	545-570	15400-PFRB-007	REC35-822626Q03	554	19233-ZV5-000	REC19233-ZV5-000	570
06192-ZV4-000	REC06192-ZV4-000	545-571	15400-PH1-F03	REC15400-PLM-A01PE	554	19234-881-850	REC19234-881-850	569
06192-ZV5-003	REC06192-ZV5-003	545-546-571	15400-PJ7-015	REC35-822626Q03	554	19234-ZW1-003	REC27-430331	569-577
06192-ZV7-000	REC06192-ZV7-000	545-571	15400-PLM-A01PE	REC15400-PLM-A01PE	554	19234-ZY3-000	REC19234-ZY3-000	570
06192-ZW1-000	REC06192-ZV1-000	546-571	15400-PM3-004	REC35-822626Q03	554	19242-ZV5-000	REC19242-ZV5-000	569
06192-ZW1-305	REC06192-ZV1-305	571	15400-PM3-405	REC35-822626Q03	554	19242-ZW1-003	REC27-430472	570-577
06192-ZW2-000	REC06192-ZV7-000	571	15400-POH-305	REC15400-PLM-A01PE	554	19300-881-741	PAF15-0700031	566
06192-ZW9-A30	REC06192-ZW9-A30	545-570	15400-POH-305PE	REC15400-PLM-A01PE	554	19300-881-761	REC19300-881-761	545-566-567
06192-ZX2-000	REC06192-ZY3-000	571	15400-RBA-F01	REC15400-RBA-F01	546-554	19300-921-003	PAF15-0700031	566
06192-ZY3-000	REC06192-ZY3-000	546-571	15400-RTA-003	REC15400-PLM-A01PE	554	19300-ZV5-003	REC19300-ZV5-043	566
06192-ZY6-000	REC06192-ZY6-000	546-571	15400-RTA-004	REC15400-PLM-A01PE	554	19300-ZV5-013	REC19300-ZV5-043	566
06193-ZV5-000	REC06193-ZV5-020	570	15400-ZJI-004	REC15400-PLM-A01PE	546-554	19300-ZV5-023	REC19300-ZV5-043	566
06193-ZV5-010	REC06193-ZV5-020	570	15400-ZW4-003	REC35-822626Q03	545-546-554	19300-ZV5-033	REC19300-ZV5-043	566
06193-ZV5-020	REC06193-ZV5-020	570	16010-ZV4-005	REC16010-ZV4-005	556	19300-ZV5-043	REC19300-ZV5-043	546-566-567
061A1-ZV0-000	RM061A1-ZV0-000	575	16010-ZW9-003	REC16010-ZW9-003	556	19300-ZW9-003	PAF15-0700031	545-546-566-567
06211-ZV1-505	REC06211-ZV1-505	545	16011-881-741	REC16011-881-741	555			567
06211-ZV4-505	REC06211-ZV4-505	545	16011-ZV4-005	REC16011-ZV4-005	555	19300-ZX2-003	REC67F-12411-01	566-567
06211-ZV5-505	REC06211-ZV5-505	545	16201-881-850	REC16201-881-850	576	19300-ZY3-023	REC6AH-12411-00	566-567
06211-ZV7-505	REC06211-ZV7-505	545	16221-ZV4-610	REC16221-ZV4-610	576	19300-ZY6-003	REC6ES-12411-30	566-567
06211-ZW0-505	REC06211-ZW0-505	546	16221-ZW1-000	REC16221-ZW1-000	576	2155-ZV5-000	CM6E0-45251-11	572
06211-ZW5-505	REC06211-ZW5-505	546	16221-ZW9-000	REC16221-ZW9-000	576	2155-ZV5-000	CM6E0-45251-11A	572
06211-ZW9-505	REC06211-ZW9-505	545	16450-ZY6-003	REC06164-PCA-000	555	23172-ZW1-013	REC23172-ZW1-013	574
06211-ZY0-505	REC06211-ZY0-505	545	16735-ZW5-003	REC16735-ZW5-003	555	23172-ZW5-013	REC23172-ZW5-013	574
06211-ZY2-506	REC06211-ZY2-506	546	16735-ZY3-004	REC16735-ZW5-003	555	24800-ZZ5-A01	REC24800-ZZ5-A02	564
06211-ZY5-505	REC06211-ZY5-505	546	16900-GB2-005	REC16910-GB2-005	545-552	24800-ZZ5-A02	REC24800-ZZ5-A02	564
06211-ZY9-505	REC06211-ZY9-505	546	16900-SA5-004	REC16900-SA5-004	545-546-552	24800-ZZ5-A22	REC24800-ZZ5-A02	564
06211-ZZ3-506	REC06211-ZZ3-506	546	16900-SR3-004	REC16900-SR3-004	546-552	24911-ZW7-U01	PRE3300C05	565
06211-ZZ5-505	REC06211-ZZ5-505	546	16900-ST5-993	REC16910-ST5-993	553	24912-ZW7-U01	PRE3300C06	565
06240-ZW5-U40	REC06240-ZW5-U40	564	16901-ZY3-003	REC16901-ZY3-003	553	24913-ZW7-U01	PRE3300C07	565
06240-ZW5-U001	REC06240-ZW5-U40	564	16910-ZV4-015	REC16910-ZV4-015	545-552	24914-ZW7-U01	PRE3300C08	565
06240-ZW5-U60	REC06240-ZW5-U60	564	16911-ZY3-003	REC16901-ZY3-003	553	24915-ZW7-U01	PRE3300C09	565
06411-ZV1-000	TEN01405	573	16911-ZY3-010	REC16911-ZY3-010	546-553	24916-ZW7-U01	PRE3300C10	565
06411-ZV1-000	TEN01406	573	16911-ZZ5-003	REC16911-ZZ5-003	546-553	24917-ZW7-U01	PRE3300C11	565
06411-ZV5-000	CM06411-ZV5-000	571	17105-ZY3-004	REC17105-ZY3-004	576	24918-ZW7-U01	PRE3300C12	565
06411-ZV5-000	CM06411-ZV5-000A	571	17105-ZY6-000	REC17105-ZY6-000	576	24919-ZW7-U01	PRE3300C13	565
06411-ZV5-000	TEN01404	573	17109-ZY3-004	REC17109-ZY3-004	576	24920-ZW7-U01	PRE3300C14	565
06411-ZV5-020	CM06411-ZV5-000	571	17109-ZY6-000	REC17109-ZY6-000	576	24921-ZW7-U01	PRE3300C15	565
06411-ZV5-020	CM06411-ZV5-000A	571	17151-ZW5-000	REC17151-ZW5-000	576	24922-ZW7-U01	PRE3300C16	565
06411-ZV5-020	TEN01404	573	17384-ZW4-000	REC17384-ZW4-000	574	24923-ZW7-U01	PRE3300C17	565
06411-ZW1-000	CM06411-ZW1-000	571	17650-921-003ZB	GS31034	548	24924-ZW7-U01	PRE3300C18	565
06411-ZW1-000	CM06411-ZW1-000A	571	17660-ZV5-902	GS31030	548	24925-ZW7-U01	PRE3300C19	565
06411-ZW1-020	CM06411-ZW1-000	571	17660-ZV5-A00	GS31031	548	24926-ZW7-U01	PRE3300C20	565
06411-ZW1-020	CM06411-ZW1-000A	571	17660-ZW9-003	GS31031	548	24927-ZW7-U01	PRE3300C21	565
06412-ZV1-000	CM31640	572	17670-ZW1-030GH	LENS3240	551	24928-ZW7-U01	PRE3300C22	565
06412-ZV1-000	CM31640A	572	17670-ZW1-030GH	RAC53240	551	24929-ZW7-U01	PRE3300C23	565
06412-ZV5-000	CM41107-ZV500	572	17670-ZW1-801AH	LENS3213	550-551	24930-ZW7-U01	PRE3300C24	565
06412-ZV5-000	CM41107-ZV500A	572	17670-ZW1-801AH	RAC53213	550-551	24931-ZW7-U01	PRE3300C25	565
06412-ZV5-000	TEN01412	573	17670-ZW3-801AH	RAC52502	553	24932-ZW7-U01	PRE3300C26	565
06412-ZV5-000	CM664-45371-01	572	17710-ZW9-023	REC17710-ZW9-033	548	24933-ZW7-U01	PRE3300C27	565
06412-ZV5-000	CM664-45371-01A	572	17710-ZW9-033	REC17710-ZW9-033	548	24934-ZW7-U01	PRE3300C28	565
08207-10W30MFC-W	REC10W30U3	553	17822-90J00	REC09401-11425	548	24935-ZW7-U01	PRE3300C29	565
08207-5W30M2	REC5W40U3	553	17822-90J00	REC09401-11425BULK	548	24936-ZW7-U01	PRE3300C30	565
08209-10W30MFC-W	REC10W30U6	553	19021-ZW1-003	REC47-43026Q06	571-577	24937-ZW7-U01	PRE3300C31	565
08739-90W	REC80W90U3	553	19120-ZW1-303	REC47-43026Q02	577	24938-ZW7-U01	PRE3300C32	565
08M60-ZW7-A00	SOL1531-140-19	581	19210-881-003	REC19210-881-003	568	30520-PNA-007	REC30520-PNA-007	559
08M60-ZW7-A10	SOL1531-140-21	581	19210-881-A01	REC19210-881-003	568	30520-PWC-501	REC30520-PWC-003	559
08M60-ZW7-A20	SOL1531-140-23	581	19210-881-A02	REC19210-881-003	568	30530-P8F-A01	REC30530-P8F-A01	558
08M60-ZW7-A30	SOL1531-140-25	581	19210-ZV4-013	CEF500328	568	30530-PNA-003	REC30530-PNA-003	558
08M60-ZW7-A40	SOL1531-145-15	581	19210-ZV4-013	REC19210-ZV4-013	567-568	30530-RNA-A01	REC30530-RNA-A01	558
116977-ZV5-900	GS31032	549	19210-ZV4-651	CEF500343	568	30580-ZV4-023	REC30580-ZV4-013	559
116977-ZV5-A00	GS31033	549	19210-ZV4-651	REC06192-ZV4-000	571	31200-ZV5-003	PH130-0054	560
12-191833	REC12-191833	545-546-575	19210-ZV4-651	REC19210-ZV4-651	567-568	31200-ZV5-013	PH130-0054	560
12155-ZV4-A00	TEN01408	573	19210-ZV5-003	CEF500338	568	31200-ZW1-004	PH130-0064	560
12155-ZV5-000	CM826134	571	19210-ZV5-003	REC19210-ZV5-003	546-568	31200-ZW5-003	PH130-0065	560
12155-ZV5-000	CM826134A	571	19210-ZV7-003	CEF500339	568	31200-ZW9-801	REC31200-ZW9-802	560
12155-ZV5-000	TEN01408/1	545-573	19210-ZV7-003	REC19210-ZV7-003	567-568	31200-ZW9-802	REC31200-ZW9-802	560
12209-GB4-681	REC12209-GB4-681	576	19210-ZW1-303	CEF500301	568	31200-ZY3-003	PH130-0070	560
12251-ZV5-000	REC12251-ZV5-003	574	19210-ZW1-303	REC47-43026Q02	567-568	31200-ZY3A-0034	PH130-0070	560
12251-ZV5-003	REC12251-ZV5-003	574	19210-ZW1-B02	REC19210-ZW1-B02	568	31200-ZY6-003	REC31200-ZY6-003	560
12251-ZV7-004	REC12251-ZV7-004	574	19210-ZW1-B04	CEF500337	568	31200-ZY9-003	REC31200-ZY6-003	560
12251-ZW1-004	REC12251-ZW1-014	574	19210-ZW1-B04	REC19210-ZW1-B02	568	31200-ZY9A-0031	REC31200-ZY6-003	560
12251-ZW1-014	REC12251-ZW1-014	574	19210-ZW9-003	REC19210-ZW9-013	567	31630-ZW5-003	REC31630-ZW5-003	561

R.O. / OEM	REF		R.O. / OEM	REF	
31630-ZY3-003	REC31630-ZY3-003	561	58233-ZY3-A19H	SOL1513-143-19	581
31630-ZY6-003	REC31630-ZY6-003	561	58233-ZY3-A21H	SOL1511-143-21	581
31630-ZY6-013	REC31630-ZY6-003	561	58233-ZY3-A21H	SOL1513-140-21	581
31638-ZY3-003	REC31638-ZY3-003	561-562	58233-ZY3-A23H	SOL1511-142-23	581
31638-ZY6-003	REC31638-ZY6-003	561-562	58233-ZY3-A23H	SOL1513-140-23	581
31908-ZZ3-003	NGKLMAR6C-9	546-559	58233-ZY3-B15H	SOL1532-145-15	581
31916-ZX2-003	NGKIZFR6K-11E	559	58233-ZY3-B17H	SOL1532-143-17	581
31916-ZY3-003	NGKIZFR6K11	546-559	58233-ZY3-B19H	SOL1532-140-19	581
35100-ZV5-013	REC35100-ZV5-013	565	90301-ZW1-003	REC90301-ZW1-003	577
35655-ZY3-013	REC35655-ZY3-013	558	90507-921-000	PAF15-04000003	545-546
35655-ZY9-003	REC35655-ZY9-003	558	90508-ZW1-003	REC90508-ZW1-003	577-579
35668-ZY6-003	REC35668-ZY6-003	558	90752-ZV4-650	REC90752-ZV4-650	569
36120-ZV5-821	PH200-T021	562	90752-ZV5-003	REC90752-ZV5-003	546-569
36120-ZV5-822	PH200-T046	562	90752-ZV7-000	REC90752-ZV7-000	569
36120-ZW4-H12	REC36120-ZW4-H12	562	90752-ZW1-003	REC90752-ZW1-B02	577
36120-ZY6-013	REC36120-ZY6-013	563	90752-ZW1-B02	REC90752-ZW1-B02	569
36120-ZY6-023	REC36120-ZY6-013	563	90752-ZY3-003	REC90752-ZY3-003	569
36120-ZY9-003	REC36120-ZY9-003	563	90758-ZV1-000	PAGB/T91-2.5X30	545-546
37260-RNA-A01	REC37260-RNA-A01	558	91051-ZW1-003	REC31-30894A1	577-579
37500-PNB-003	REC37500-PNB-003	557	91053-ZW1-003	REC387247	577-579
37510-PNB-003	REC37510-PNB-003	557	91057-ZW1-003	REC31-30895T	577-579
37830-PGK-A01	REC37830-PGK-A01	557	91251-ZW1-003	REC26-43035	577-578
37830-PNC-003	REC37830-PNC-003	557	91252-935-004	REC91252-935-004	570
37830-RNA-A01	REC37830-RNA-A01	557	91252-ZV1-003	REC91252-ZV1-003	570
37840-R70-A01	REC37840-R70-A01	557	91252-ZW1-003	REC26-76868	577-578
37880-PLC-004	REC37880-PLC-004	558	91253-ZW1-003	REC26-8164641	577-578
41106-935-812	TEN01401	573	91254-ZW1-003	REC26-43036	577-578
41106-ZV4-650	TEN01402	545-573	91255-ZW1-003	REC26-70081	578
41106-ZW-000	TEN01400	573	91351-ZW1-003	REC26-70081	577-578
41106-ZW9-000	CM41106-ZW9-000A	572	91353-ZW1-003	REC25-457101	5779578
41106-ZW9-000	CM41106-ZW9-09000	572	98059-55916	NGKCR5EH-9	545-559
41106-ZW9-000	TEN01409	573	98066-55716	NGKDR5HS	559
41106-ZW9-090	CM41106-ZW9-09000	545	98069-5771P	NGKDR7EA	545-546-559
41106ZW909000	CM41106-ZW9-000A	572	98069-5777P	NGKDR7EB	546
41106ZW909000	CM41106-ZW9-09000	572	98079-55846	NGKBPR5ES	545-559
41107-ZV1-003-ZA	TEN01411	573			
41107-ZV5-000	CM41107-ZV500A	545			
41107-ZV5-000	TEN01403	573			
41107-ZW1-B01ZA	TEN01410	573			
411072ZW1003	CM31640	572			
411072ZW1003	CM31640A	572			
41107ZV500	CM41107-ZV500	572			
41107ZV500	CM41107-ZV500A	572			
41107ZW1-B01	CM41107-ZW1-B01	572			
41107ZW1-B01	CM41107-ZW1-B01A	572			
41109-ZV5-000	REC41109-ZV5-000	579			
41109-ZW1-003	CM826134	571			
41109-ZW1-003	CM826134A	571			
41109-ZW1-B00	CM41109-ZW1-B00	571			
41109-ZW1-B00	CM41109-ZW1-B00A	571			
41109-ZW1-B00	TEN01407	573			
41161-ZV5-000	REC41161-ZV5-000	579			
58130-ZV0-841ZB	SOL6001-073-06P	581			
58130-ZV4-030ZB	SOL3111-093-09	581			
58130-ZV4-703ZB	SOL3111-093-08	581			
58130-ZV5-000ZA	SOL3311-111-13	581			
58130-ZV5-850ZA	SOL3311-114-12	581			
58130-ZV5-860ZA	SOL3311-121-09	581			
58130-ZV5-870ZA	SOL3311-111-14	581			
58130-ZV7-000ZA	SOL5211-099-11	581			
58130-ZV7-850ZA	SOL5211-099-09	581			
58130-ZW1-W01ZA	SOL6411-140-11	581			
58130-ZW1-W01ZA	SOL6431-140-11	581			
58130-ZW1-W11ZA	SOL6411-138-13	581			
58130-ZW1-W11ZA	SOL6413-133-13	581			
58130-ZW1-W11ZA	SOL6431-138-13	581			
58130-ZW1-W21ZA	SOL6411-135-15	581			
58130-ZW1-W21ZA	SOL6413-130-15	581			
58130-ZW1-W21ZA	SOL6431-135-15	581			
58130-ZW1-W31ZA	SOL6411-133-17	581			
58130-ZW1-W31ZA	SOL6412-135-15	581			
58130-ZW1-W31ZA	SOL6431-133-17	581			
58130-ZW1-W41ZA	SOL6411-130-19	581			
58130-ZW1-W41ZA	SOL6411-130-21	581			
58130-ZW1-W41ZA	SOL6413-125-19	581			
58130-ZW1-W41ZA	SOL6413-125-21	581			
58130-ZW1-W41ZA	SOL6431-130-19	581			
58130-ZW1-W41ZA	SOL6431-130-21	581			
58130-ZW1-W61ZA	SOL6412-133-17	581			
58233-ZY3-A15H	SOL1511-150-15	581			
58233-ZY3-A15H	SOL1513-148-15	581			
58233-ZY3-A17H	SOL1511-148-17	581			
58233-ZY3-A17H	SOL1513-145-17	581			
58233-ZY3-A17H	SOL1531-143-17	581			
58233-ZY3-A19H	SOL1511-145-19	581			

# TOHATSU

**ES**

GUÍA MANTENIMIENTO	589	IGNICIÓN	599	DESPIECE MOTOR DE 4 TIEMPOS	613
<b>SISTEMA DE ALIMENTACIÓN Y FILTRACIÓN</b>	590	CARGA	599	MFS8 • MFS9.9	613
ACEITE	595	BUJÍAS	600	DESPIECE MOTOR DE 2 TIEMPOS	608
BOMBA DE COMBUSTIBLE EN LÍNEA	590	CDI Y CAJAS NEGRAS	601	M4C • M5B • M5BS	608
ABRAZADERA PARA MANGUERA	591	MOTORES DE ARRANQUE	600	M6B • M8B • M9.8B	609
ADAPTADOR LÍNEA DE COMBUSTIBLE	591	SENSORES	598	M9.9D • M15D2 • M18E2	610
BOMBA DE COMBUSTIBLE	590	SENSOR PRESIÓN ACEITE	598	M25C3 • M30A4	611
LÍNEA DE COMBUSTIBLE	590	SENSOR DE OXÍGENO	598	M40D2 • M50D2	612
MANGUERA DE COMBUSTIBLE	590	SENSOR ÁRBOL DE LEVAS	598	<b>JUNTAS DE MOTOR 4 TIEMPOS</b>	617
MUELLE TUBO COMBUSTIBLE	591	TRIM, TILT & POWER TRIM	602	JUNTAS BASE DE MOTOR	618
BOMBA DE COMBUSTIBLE	596	INSTALACIÓN ELÉCTRICA	602	JUNTAS CULATÍN	617
KITS MEMBRANAS Y JUNTAS	596	POWER TRIM COMPLETO	602	JUNTAS DE CULATA	617
CARBURADOR	596	TRIM COMPLETO	602	KIT JUNTAS DE CULATA	617
BOYAS	597	<b>SISTEMA DE GOBIERNO</b>	603	PISTONES	619
CARBURADOR COMPLETO	596	COMPONENTES	603	KIT DE PISTONES	619
KITS CARBURADORES	597	CABLES DE ACELERADOR	603	RETENES DE ACEITE	618
<b>COMPONENTES TANQUE Y CONECTORES</b>	591	<b>SISTEMA DE REFRIGERACIÓN</b>	603	<b>SISTEMA DE ESCAPE Y ADMISIÓN</b>	621
CONECTOR DE DEPÓSITO	591	ÁNODOS	606	SISTEMA DE ADMISIÓN	621
PASAMAMPAROS	592	ÁNODO CANADA METAL	606	JUNTAS DE ADMISIÓN	621
FILTRO DE ACEITE	596	ÁNODO TECNOSEAL	607	<b>SISTEMA DE ESCAPE</b>	621
FILTRO DE COMBUSTIBLE Y ELEMENTOS	592	BOMBA DE AGUA	605	JUNTAS DE ESCAPE	621
BRACKET	592	CASQUILLO INOX	605	<b>UNIDADES DE TRANSMISIÓN</b>	622
FILTRO DECANTADOR DE COMBUSTIBLE COMPLETO CON VASO TRASPARENTE	593	JUNTAS BOMBA	605	DESPIECE COLAS 4 TIEMPOS	622
FILTRO DECANTADOR DE GASOLINA	593	JUNTAS BASE DE BOMBA	605	MFS8 • MFS9.8	622
FILTRO COMBUSTIBLE MONTAJE EN LÍNEA	594	KITS DE REPARACIÓN BOMBA DE AGUA	605	GUÍA PIEZA DE COLA	626
FILTRO COMBUSTIBLE SEPARADOR AGUA	592	IMPULSORES	604	<b>SISTEMA DE PROPULSIÓN</b>	627
LLAVES PARA FILTRO	594	TERMOSTATO	603	HÉLICES ALUMINIO E INOXIDABLE DE 3 Y 4 PALAS	627
RACOR DE LATÓN	594	JUNTAS TAPA DE REFRIGERACIÓN	604	GUÍA HÉLICES CON NÚCLEO INTEGRADO	628
<b>SISTEMA ELÉCTRICO</b>	598	JUNTA TERMOSTATO	604	HÉLICES PARA NÚCLEO INTERCAMBIABLE	629
BOBINAS	598	<b>PARTES DEL MOTOR</b>	608	NÚCLEO INTERCAMBIABLE	629
ALTA PRESIÓN	599	CIGÜEÑAL	619	REF --> RO	630
PULSACIÓN	599	RODAMIENTOS	619	RO --> REF	

**EN**

DRIVES MAINTENANCE GUIDE & KITS	589	IGNITION COIL	599	ENGINE GASKETS 4 STROKES	617
<b>FUEL &amp; FILTRATION SYSTEM</b>	590	CHARGER COIL	599	GASKET, CYLINDER COVER	617
CARBURATOR	596	SENSORS	598	GASKET, CYLINDER HEAD	617
CARBURETOR KITS	597	SENSOR, OIL PRESURE	598	GASKET KIT, CYLINDER HEAD	617
FLOATS	597	SENSOR, OXYGEN	598	<b>ENGINE PARTS 2 STROKES</b>	608
FULL CARBURATOR	596	SENSOR, CAMSHAFT	598	M4C • M5B • M5BS	608
<b>FUEL FILTERS AND ELEMENTS</b>	592	SPARK	600	M6B • M8B • M9.8B	609
BRACKET	592	STARTERS	600	M9.9D • M15D2 • M18E2	610
COMPLET FUEL FILTER	594	TRIM, TILT & POWER TRIM	602	M25C3 • M30A4	611
COMPLET FUEL FILTER WITH TRANSPARENT BOWL	593	COMPLETE POWER TRIM ASSEMBLY	602	M40D2 • M50D2	612
FILTER KEY	594	COMPLETE TRIM ASSEMBLY	602	<b>ENGINE PARTS 4 STROKES</b>	613
IN-LINE FUEL FILTER	594	WIRING HARNESS	602	MFS8 • MFS9.9	613
RACORS	594	<b>STEERING SYSTEM</b>	603	PISTONS	619
WATER SEPARATING FUEL FILTER	592	COMPONENTS	603	PISTON KITS	619
<b>FUEL PUMP</b>	596	CONTROL CABLES	603	<b>OIL SEALS</b>	618
DIAPHRAGMS & GASKETS	596	<b>COOLING SYSTEM</b>	603	<b>EXHAUST &amp; INTAKE SYSTEM</b>	621
<b>FUEL PUMP IN LINE</b>	590	ANODES	606	EXHAUST SYSTEM	621
CLAMP SMALL	591	ANODES CANADA METAL	606	GASKETS	621
COUPLER	591	ANODES TECNOSEAL	607	<b>INTAKE SYSTEM</b>	621
FUEL HOSE	590	IMPELLERS	604	GASKETS	621
FUEL LINE ASSEMBLY	590	TERMOSTAT	603	<b>UNIT DRIVES &amp; COMPONENTS</b>	622
SPRING, FUEL PIPE	591	GASKET BASE	603	DRIVE COMPONENTS GUIDE	626
<b>FUEL TANK COMPONENTS &amp; CONNECTORS</b>	591	EXHAUST INNER COVER	604	GEAR CASE PARTS 4 STROKES	622
TANK CONNECTOR	591	<b>WATER PUMP</b>	605	MFS8 • MFS9.8	622
THRU HULL	592	GASKET	605	<b>PROPULSION SYSTEM</b>	627
<b>OIL</b>	595	GASKET BASE	605	3 & 4 BLADE ALUMINIUM & SS PROPELLERS	627
<b>OIL FILTER</b>	596	INSERT CUP	605	INTERCHANGEABLE HUB	629
<b>ELECTRIC SYSTEM</b>	598	SERVICE KIT	605	PROPELLERS APPLICATION WITH RUBBER HUB	629
CDI & POWER PACK	601	<b>ENGINE PARTS</b>	608	PROPELLERS FOR INTERCHANGEABLE HUB	629
<b>COILS</b>	598	CRANKSHAFT	619	REF --> OEM	630
COIL HIGH PRESSURE	599	CRANKSHAFT BEARINGS	619	OEM --> REF	632
PULSER COIL	599				

TOHATSU

RECAMBIOS MARINOS

# IT

<b>GUIDA MANUTENZIONE E KIT</b>	589	<b>CDI E CENTRALINA</b>	601	<b>GUARNIZIONE BASE MOTORE</b>	618
<b>SISTEMA DI ALIMENTAZIONE E FILTRAZIONE</b>	590	<b>MOTORINI AVVIAMENTO</b>	600	<b>GUARNIZIONE TESTATA</b>	617
<b>CARBURATORE</b>	596	<b>SENSORE</b>	598	<b>GUARNIZIONE COPERCHIO TESTA</b>	617
CARBURATORE COMPLETO	596	SENSORE PRESIONE OLIO	598	<b>KIT GUARNIZIONE TESTATA</b>	617
GALLEGGIANTE	597	SENSORE OSSIGENO	598	<b>PARAOILIO</b>	618
KIT CARBURATORI	597	SENSORE ALBERO A CAMME	598	<b>PARTI MOTORE 4 TEMPI</b>	613
<b>COMPONENTI SERBATOIO E CONNETTORI</b>	591	<b>TRIM, TILT &amp; POWER TRIM</b>	602	MFS8 • MFS9.9	613
ATTACCO SERBATOIO	591	INSTALLAZIONE ELETTRICA	602	<b>PARTI MOTORE 2 TEMPI</b>	608
PASSASCAFO	592	MOTORINO POWER TRIM COMPLETO	602	M4C • M5B • M5BS	608
<b>FILTRI BENZINA E RACCORDI</b>	592	MOTORINO TRIM COMPLETO	602	M6B • M8B • M9.8B	609
CHIAVE DA FILTRO	594	<b>SISTEMA DI GUIDA</b>	603	M9.9D • M15D2 • M18E2	610
FILTRO BENZINA PER MONTARE IN LINEA	594	<b>COMPONENTI</b>	603	M25C3 • M30A4	611
FILTRO DECATATORE BENZINA	593	CAVO ACCELERATORE	603	M40D2 • M50D2	612
FILTRO DI DECANTAZIONE BENZINA	593	<b>SISTEMA DI RAFFREDDAMENTO</b>	603	<b>PISTONE</b>	619
COMPLETO CON VASCHETTA TRASPARENTE	593	<b>ANODI</b>	606	<b>KIT PISTONE</b>	619
FILTRO SEPARATORE ACQUA-BENZINA	592	ANODI CANADA METAL	606	<b>SISTEMA DI SCARICO E ASPIRAZIONE</b>	621
RACCORDI	594	ANODI TECNOSEAL	607	<b>SISTEMA ASPIRAZIONE</b>	621
SUPPORTO	592	<b>GIRANTE</b>	604	GUARNIZIONE	621
<b>FILTRO OLIO</b>	596	GUIDA GIRANTE	604	<b>SISTEMA SCARICO</b>	621
<b>OLIO</b>	595	<b>POMPA ACQUA</b>	605	GUARNIZIONE	621
<b>POMPA BENZINA</b>	596	GHIERA INOX	605	<b>UNITÀ DI TRASMISSIONE</b>	622
MEMBRANA E GUARNIZIONI	596	GUARNIZIONE BASE POMPA	605	<b>GUIDA COMPONENTI PIEDI</b>	626
<b>POMPA BENZINA IN LINEA</b>	590	GUARNIZIONE POMPA	605	<b>PARTI PIEDI 4 TEMPI</b>	622
ADATTATORE	591	KIT RICAMBI POMPA ACQUA	605	MDF8 • MSF9.8	622
FASCETTE	591	<b>TERMOSTATO</b>	603	<b>SISTEMA DI PROPULSIONE</b>	627
MOLLA TUBO COMBUSTIBILE	591	GUARNIZIONE TERMOSTATO	604	<b>ELICHE ALLUMINIO E INOX DA 2 E 4 PALE</b>	627
POMPA BENZINA	590	GUARNIZIONE COPERCHIO	604	ELICHE PER MOZZO INTERCAMBIABILE	629
TUBO BENZINA	590	REFRIGERAZIONE	604	GUIDA ELICHE CON MOZZO	628
<b>SISTEMA ELETTRICO</b>	598	<b>PARTI MOTORE</b>	608	MOZZO INTERCAMBIABILE	629
<b>BOBINE</b>	598	<b>ALBERO MOTORE</b>	619	REF --> RO	630
BOBINA ALTA PRESSIONE	599	CUSCINETTI ALBERO MOTORE	619	RO --> REF	632
BOBINA ACCENSIONE	599	<b>GUARNIZIONI MOTORE 4 TEMPI</b>	617		
BOBINA AVVIAMENTO	599				
BOBINA DI CARICA	599				
<b>CANDELE</b>	600				

# FR

<b>GUIDE MAINTENANCE KITS</b>	589	<b>BOBINE D'ALLUMAGE</b>	599	<b>JOINTS DE TÊTE MOTRICE</b>	618
<b>SYSTÈME D'ALIMENTATION ET DE FILTRATION</b>	590	<b>BOBINE DE CHARGE</b>	599	<b>KIT JOINTS DE MOTEUR</b>	617
<b>CARBURATEUR</b>	596	<b>BOUGIES</b>	600	<b>PIÈCES MOTEURS DE 4 TEMPS</b>	613
CARBURATEUR COMPLET	596	<b>CAPTEURS</b>	598	MFS8 • MFS9.9	613
FLOTTEUR DE CARBURATEUR	597	CAPTEUR PRESION HUILE	598	<b>PIÈCES MOTEUR 2 TEMPS</b>	608
KIT CARBURATEUR	597	CAPTEUR À OXYGENE	598	M4C • M5B • M5BS	608
<b>COMPOSANTS ET CONNECTEURS DU RÉSERVOIR</b>	591	CAPTEUR DE POSITION D'ARBRE À CAMES	598	M6B • M8B • M9.8B	609
PASSE-CLOISON	592	<b>CDI ET BOITIER ELECTRONIQUE</b>	601	M9.9D • M15D2 • M18E2	610
RACCORDS DE RESERVOIR	551	DEMARREUR	600	M25C3 • M30A4	611
<b>FILTRE À ESSENCE ET CARTOUCHE DE RECHANGE</b>	592	<b>TRIM, TILT &amp; POWER TRIM</b>	602	M40D2 • M50D2	612
CLÉ À FILTRE	594	INSTALLATION ELECTRIQUE	602	<b>PISTONS</b>	619
FILTRE DÉCANTEUR ESSENCE	593	MOTEUR DE TRIM	602	<b>KIT PISTON</b>	619
FILTRE DÉCANTEUR ESSENCE AVEC BOL TRANSPARENT	593	POWER TRIM COMPLET	602	<b>VILEBREQUIN</b>	619
FILTRE À ESSENCE EN LIGNE	594	<b>SYSTÈME DE COMMANDE</b>	603	ROULEMENTS VILEBREQUIN	619
FILTRE SÉPARATEUR EAU-ESSENCE	592	<b>COMPOSANT</b>	603	<b>SYSTÈME D'ÉCHAPPEMENT ET SYSTÈME D'ADMISSION</b>	621
RACCORDS	594	CÂBLE D'ACCELERATEUR	603	<b>SYSTÈME D'ADMISSION</b>	621
TÊTE DE FILTRE À ESSENCE	592	<b>SYSTÈME DE REFROIDISSEMENT</b>	603	JOINTS	621
<b>FILTRE À HUILE</b>	596	<b>ANODES</b>	606	<b>SYSTÈME D'ÉCHAPPEMENT</b>	621
<b>HUILES</b>	595	ANODE CANADA METAL	606	JOINTS	621
<b>POIRE À CARBURANT</b>	590	ANODE TECNOSEAL	606	<b>EMBASES ET PIÈCES</b>	622
COLLIER	591	<b>TURBINES</b>	604	<b>PIÈCES D'EMBASES DE 4 TEMPS</b>	622
POIRE À CARBURANT	591	<b>POMPE D'EAU</b>	605	MFS8 • MFS9.9	622
RACCORD COUPLEUR	591	INSERT INOX	605	<b>GUIDE PIÈCES D'EMBASES</b>	626
RESSORT, TUYAU DE CARBURANT	591	JOINTS, BASE DE POMPE À EAU	605	<b>SYSTEME DE PROPULSION</b>	627
TUYAU CARBURANT	590	JOINTS POMPE	605	<b>HÉLICE ALUMINIUM ET INOX 3 ET 4 PALES</b>	627
<b>POMPE À ESSENCE</b>	596	KIT REPARATION DE POMPE À EAU	605	GUIDE DES HÉLICES ET MOYEUR	628
MEMBRANES ET JOINTS	596	<b>THERMOSTAT</b>	603	HELICES AVEC MOYEU INTERCHANGEABLE	628
<b>SYSTÈME ÉLECTRIQUE</b>	598	JOINT THERMOSTAT	604	MOYEU INTERCHANGEABLE	629
<b>BOBINES</b>	598	JOINT COUVERCLE THERMOSTAT	604	REF --> RO	630
BOBINE HAUTE PRESION	599	<b>PIÈCES MOTEUR</b>	608	RO --> REF	632
BOBINE PULSEUR	599	<b>JOINTS DE MOTEUR 4 TEMPS</b>	617		
		JOINTS COUVRE CULASSE	617		
		JOINTS DE CULASSE	617		

MAINTENANCE  
GUIDE

GUIDA  
MANUTENZIONE

GUIDE  
MAINTENANCE

	REF					
MFS4 MFS5 MFS6	NGKDCPR6E	BUJÍA	SPARK PLUG	CANDELE	BOUGIE	1
	TEN01259	ÁNODO	ANODE DRIVE	ANODO	ANODE	1
	CEF500377	IMPULSOR	IMPELLER	GIRANTE	TURBINE	1
	PAF4-05000300	FILTRO COMBUSTIBLE	FUEL FILTER	FILTRO BENZINA	FILTRE À ESSENCE	1
MFS8 MFS9.8	NGKDCPR6E	BUJÍA	SPARK PLUG	CANDELE	BOUGIE	2
	TEN01258	ÁNODO BLOQUE	ANODE ENGINE	ANODO MOTORE	ANODE MOTEUR	1
	CEF500344	IMPULSOR	IMPELLER	GIRANTE	TURBINE	1
	PAF4-05000300	FILTRO COMBUSTIBLE	FUEL FILTER	FILTRO BENZINA	FILTRE À ESSENCE	1
	REC855676002	TERMOSTATO	THERMOSTAT	TERMOSTATO	TERMOSTAT	1
	PAF8-05000004	CORREA DISTRIBUCIÓN	TIMING BELT	CINGHIE DISTRIBUZIONE	COURROIE DE DISTRIBUTION	1
	TEN01260	ÁNODO COLA	ANODE DRIVE	ANODO PIEDE	ANODE EMBASSE	1
MFS9.9 MFS15 MFS18	NGKDCPR6E	BUJÍA	SPARK PLUG	CANDELE	BOUGIE	2
	TEN01258	ÁNODO BLOQUE	ANODE ENGINE	ANODO MOTORE	ANODE MOTEUR	1
	CEF500383	IMPULSOR	IMPELLER	GIRANTE	TURBINE	1
	PAF4-05000300	FILTRO COMBUSTIBLE	FUEL FILTER	FILTRO BENZINA	FILTRE À ESSENCE	1
	REC5GH-13440-00	FILTRO ACEITE	OIL FILTER	FILTRO OLIO	FILTRE À HUILE	1
	REC855676002	TERMOSTATO	THERMOSTAT	TERMOSTATO	TERMOSTAT	1
	TEN01250	ÁNODO TRANSOM	TRANSOM ANODE	ANODO TRANSOM	ANODE TRANSOM	1
MFS25 MFS30	NGKDCPR6E	BUJÍA	SPARK PLUG	CANDELE	BOUGIE	2
	TEN01258	ÁNODO BLOQUE	ANODE ENGINE	ANODO MOTORE	ANODE MOTEUR	1
	CEF500382	IMPULSOR	IMPELLER	GIRANTE	TURBINE	1
	PAF4-05000300	FILTRO COMBUSTIBLE	FUEL FILTER	FILTRO BENZINA	FILTRE À ESSENCE	1
	REC855676002	TERMOSTATO	THERMOSTAT	TERMOSTATO	TERMOSTAT	1
	REC5GH-13440-00	FILTRO ACEITE	OIL FILTER	FILTRO OLIO	FILTRE À HUILE	1
	TEN01256	ÁNODO TRANSOM	TRANSOM ANODE	ANODO TRANSOM	ANODE TRANSOM	1
	TEN01253	ÁNODO COLA	ANODE DRIVE	ANODO PIEDE	ANODE EMBASE	1

# SISTEMA DE ALIMENTACIÓN Y FILTRACIÓN FUEL & FILTRATION SYSTEM

# SISTEMA DI ALIMENTAZIONE E FILTRAZIONE SYSTÈME D'ALIMENTATION ET DE FILTRATION

## BOMBA DE COMBUSTIBLE

## FUEL PUMP

## POMPA BENZINA

## POIRE À CARBURANT

### BOMBA DE COMBUSTIBLE

### FUEL PUMP

### POMPA BENZINA

### POIRE À CARBURANT

Fabricada con elastómeros termoplásticos inyectados, resistentes al alcohol y rayos UV.s

Premium quality bulb resistance to alcohol as well as UV and ozone.

Fabbricata con elastomero termoplastico, resistente ai solventi e raggi UV.

Fabriqué avec des élastomères thermoplastiques injectés, résistant à l'alcool et aux rayons UV.

REF		
GS31187	1/4" = 6 mm	1
GS31090	5/16" = 8 mm	1
GS31095	3/8" = 9.5 mm	1
GS31090	5/16" = 8 mm	1

 GOLDENSHIP



### LÍNEA DE COMBUSTIBLE

### FUEL LINE ASSEMBLY

### TUBO CARBURANTE

### TUYAU CARBURANT

Universal. Manguera resistente al alcohol.

Universal. Alcohol resistant hose.

Universale. Tubo resistente ai solventi.

Universel. Tuyau résistant à l'alcool.

REF		
GS31096	5/16" x 2 m	1
GS31097	3/8" x 2 m	1
GS31099	8 mm x 2 m	1
SIE18-8013	5/16" x 2 m	1
SIE18-8015	3/8" x 2 m	1



REF		
GS31189	3/8" x 2 m	1

  GOLDENSHIP



REF		
GS31183	6 mm x 2 m	1

 GOLDENSHIP

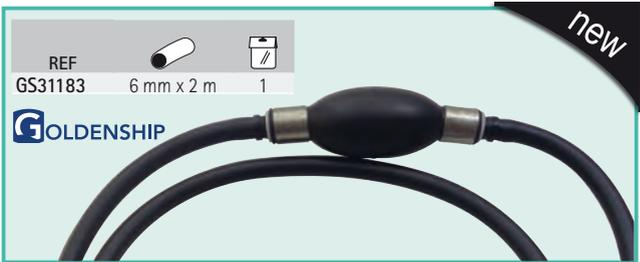

### MANGUERA DE COMBUSTIBLE

### FUEL HOSE

### TUBO BENZINA

### TUYAU CARBURANT

Manguera «Trident» para líneas de combustible. Con refuerzo termoplástico que le permite excelente flexibilidad y resistencia a los rayos UV. Color gris. Resistente al alcohol. Especialmente indicado para motores fueraborda. Garantía: 3 años

Marine fuel hose (distribution and vent) for outboards. Fuel resistant thermo-plastic formulation with 2 spiral reinforcement provides excellent bendability and resistance to UV, aging and permeation by all marine fuels (gasoline/petrol and diesel) including alcohol blends. Warranty: 3 years

Tubo «Trident» per linea combustibile. Con rinforzo termoplastico che gli permette un'eccellente flessibilità e resistenza ai raggi UV. Colore grigio. Resistente ai solventi. Indicato per i motori fuoribordo. Garanzia: 3 anni

Tuyau «Trident» pour carburant. Avec renfort thermoplastique qui permet une excellente flexibilité et résistance aux rayons UV. Gris. Résistant à l'alcool. Convient particulièrement aux moteurs hors-bord. Garantie: 3 ans

REF				
TRI305-0566	5/16" = 7,92 mm	15 m	1	SAEJ1527
TRI305-0386	3/8" = 9,53 mm	15 m	1	ISO-8469 B1 CE



 TRIDENT  
  CE CERTIFIED

De goma para diesel y gasolina sin plomo. Ideal para fueraborda. Refuerzos textiles internos. Muy flexible. Contenido aromático 50%

Rubber Hose suitable for loading mineral oils, diesel and unloaded fuel

In gomma per diesel e benzina senza piombo. Ideale per motori fuoribordo. Tessuto interno rinforzato. Molto flessibile.

Caoutchouc pour diesel et essence sans plomb. Idéal pour le hors-bord. Renforts textiles internes. Très flexible

### CARBUPOMP/10NL

REF						
GS35031	6x12	10 bar	50 mm	-25°C → 80°C	50 m	ISO R1307
GS35032	8x15	10 bar	65 mm		50 m	

H.T. - CARBUPOMP/10NL - WP 10 BAR - R-1M Q/m - ISO R1307

 ht  
hoses technology



<b>MUELLE TUBO COMBUSTIBLE</b>	<b>SPRING, FUEL PIPE</b>	<b>MOLLA TUBO COMBUSTIBLE</b>	<b>RESSORT, TUYAU DE CARBURANT</b>	<b>new</b>
REF PAF4-04000030 PAF4-05000010				

<b>ABRAZADERA</b>	<b>CLAMP SMALL</b>	<b>FASCETTE</b>	<b>COLLIER</b>	<b>new</b>
REF REC650-24351-51 6 mm REC6E5-24351-51 8 mm		REF REC09401-11425 6-8 mm 1 REC09401-11425BULK 6-8 mm 25		

<b>ADPATADOR LÍNEA DE COMBUSTIBLE</b>	<b>COUPLER</b>	<b>ADATTATORE</b>	<b>RACCORD COUPLEUR</b>
REF REC22-8M0001721 Ø 11 mm --> Ø 9 mm			

<b>COMPONENTES TANQUE Y CONECTORES</b>	<b>FUEL TANK COMPONENTS &amp; CONNECTORS</b>	<b>COMPONENTI SERBATOIO E CONETTORI</b>	<b>COMPOSANTS ET CONNECTEURS DU RESERVOIR</b>
<b>CONECTOR DE DEPÓSITO LATÓN</b>	<b>TANK CONNECTOR BRASS</b>	<b>ATTACCO SERBATOIO OTTONE</b>	<b>RACCORDS DE RESERVOIR LAITON</b>
REF GS31068 1/4" NPT 1			



Para conectar dos motores a un sólo depósito, o viceversa. To connect two motors to a single tank, or vice versa. Per collegare due motori a un singolo serbatoio o viceversa. Pour connecter deux moteurs à un même réservoir, ou inversement.

REF GS31069 1/4" NPT 1			
---------------------------	-------------------------------------------------------------------------------------	--	-------------------------------------------------------------------------------------

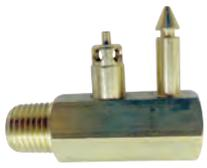

REF GS31073 1/4" NPT			REF GS31020 1/4" NPT		
-------------------------	-------------------------------------------------------------------------------------	-------------------------------------------------------------------------------------	-------------------------	---------------------------------------------------------------------------------------	-------------------------------------------------------------------------------------



<b>CONECTOR DE DEPÓSITO</b>	<b>TANK CONNECTOR</b>	<b>ATTACCO SERBATOIO</b>	<b>RACCORDS DE RESERVOIR</b>
REF GS31088 3B2-702501M 3/8"	COMPATIBLE CON CONECTOR COMPATIBLE WITH CONNECTOR COMPATIBLE CON CONNETTORE COMPATIBLE AVEC CONECTEUR 2T STROKES 4T STROKES 5 ---> 90 HP	REF GS31019 99998-OMA2 1/4" NPT	COMPATIBLE CON CONECTOR COMPATIBLE WITH CONNECTOR COMPATIBLE CON CONNETTORE COMPATIBLE AVEC CONECTEUR 2T STROKES 4T STROKES GS31088
			



REF	OEM	2T STROKES	4T STROKES	COMPATIBLE CON CONECTOR COMPATIBLE WITH CONNECTOR COMPATIBILE CON CONNETTORE COMPATIBLE AVEC CONECTEUR
GS31016	3B2-702801M	3/8"	✓	GS31017

5 --> 90 HP

REF	OEM	2T STROKES	4T STROKES	COMPATIBLE CON CONECTOR COMPATIBLE WITH CONNECTOR COMPATIBILE CON CONNETTORE COMPATIBLE AVEC CONECTEUR
GS31017		1/4" NPT	✓	GS31016

5 --> 90 HP

REF	OEM	2T STROKES	4T STROKES	GOLDENSHIP
GS31018	3B2-702601M	Metrica	✓	

5 --> 90 HP

REF	OEM	2T STROKES	4T STROKES	GOLDENSHIP
GS31015	394-702500M	3/8"	✓	

PASAMAMPAROS	THRU HULL	PASSASCAFO	PASSE-CLOISON
Para atravesar mamparos de hasta 12 mm. Fabricado en latón.	For bulkhead up to 12 mm. Made in machined brass.	Per attraversare paratie fino a 12 mm. Fabricato in ottone.	Pour traverser des cloisons jusqu'à 12 mm. Fait en laiton.

REF	2T STROKES	4T STROKES
GS31064	3/8"	1

FILTRO DE COMBUSTIBLE Y ELEMENTOS	FUEL FILTERS AND ELEMENTS	FILTRI BENZINA E RACCORDI	FILTRE A ESSENCE ET CARTOUCHE DE RECHANGE
BRACKET	BRACKET	SUPPORTO	TÊTE DE FILTRE À ESSENCE
Con 2 tapones de bronce y 2 tubos de extensión. (2 entradas y 2 salidas).	With 2 brass plugs and 2 extension tubes. (2 inputs & 2 outputs).	Con 2 tappi di bronzo e 2 tubi di estensione. (2 ingressi entrata carburante e 2 uscite carburante).	Avec 2 bouchons en bronze et 2 tubes d'extension. (2 entrées et 2 sorties).

REF	2T STROKES	4T STROKES
REC25000	1/4"	AL
REC25010	1/4"	INOX /SS AISI316
REC25020	3/8"	AL
REC25030	3/8"	INOX /SS AISI316
RECOBBRACKET	1/4"	Plástico   Plastic Plastica   Plastique

REC25000 - REC25020      REC25010 - REC25030      RECOBBRACKET

FILTRO COMBUSTIBLE SEPARADOR DE AGUA	WATER SEPARATING FUEL FILTER	FILTRO SEPARATORE ACQUA-BENZINA	FILTRE SEPARATEUR EAU-ESSENCE
REC24942	10 MICRON		
REC35-802893Q01	3Y7-02234-0		
REC855686	28 MICRON		
REC35-802893Q	25 MICRON		
RACPF5510	10 MICRON		

RACPF5510      REC24942      REC35-802893Q01      REC855686      REC35-802893Q

Filtro original.	OEM filter.	Filtro benzina originale.	Filtre à essence d'origine
REF	MICRON		
RM35-802893Q	10		

**FILTRO CON BRACKET**  
Con 2 tapones de bronce y 1 tubo de extensión.

**OEM FILTER WITH BRACKET**  
With 2 brass plugs & 1 extension tube.

**FILTRO BENZINA CON SUPPORTO**  
Con 2 tappi di bronzo e 1 tubo di estensione.

**FILTRE A ESSENCE AVEC SUPPORT**  
avec 2 bouchons en bronze et 1 tube d'extension

REF	MICRON			
REC24950	25	1/4"	50 GPH	AL
REC24952	10	1/4"	50 GPH	AL



**FILTRO DECANTADOR DE COMBUSTIBLE COMPLETO CON VASO TRASPARENTE**

**COMPLET FUEL FILTER WITH TRANSPARENT BOWL**

**FILTRO DI DECANTAZIONE BENZINA COMPLETO CON VASCHETTA TRASPARENTE**

**FILTRE DÉCANTEUR ESSENCE AVEC BOL TRANSPARENT**

REF		
RAC320R-RAC-01		AL
RAC320R-RAC-03	RACS3213 LENS3213	Plástico Plastic Plastica Plastique



REF			
RECOFILALU			AL
RECOFILTER	RECOBELEMENT LENS3213	150 l/h	Plástico Plastic Plastica Plastique



**FILTRO CON BOMBA CEBADORA**

**FILTER WITH PRIMMING PUMP**

**FILTRO CON POMPETA PER RIEMPIRE**

**FILTRE A ESSENCE AVEC POMPE D'AMORCAGE**

REF		MICRON			
RAC490R-RAC-01	RACS3227 LENS3227	10	340 l/h	3/8" NPTF	150 hp



**FILTRO DECANTADOR GASOLINA**

**COMPLETE FUEL FILTER**

**FILTRO DECANTATORE BENZINA**

**FILTRE DÉCANTEUR ESSENCE**

Filtro de combustible con braket.

Complete fuel filter with braket.

Filtro combustibile con supporto.

Filtre à carburant avec support.

REF	
RAC23299-10	RAC23289-10

130 HP (4 T/ Strokes)



REF	MICRON	Flow	HP
REC90794-46866	10	117 l/h	175 hp



**LLAVE PARA FILTRO**  
**FILTER KEY**  
**CHIAVE DA FILTRO**  
**CLÉ A FILTRE**

REF
RECYS-225-15



REF	MICRON	Flow
PAF40-0701000EI	10	70 hp



new

**RÁCORES**      **RACORS**      **RACCORDI**      **RACCORDS**

REF	Thread	Size	Qty
GS31065	1/4" NPT	3/8" = 9.5 mm	1
GS31166	1/4" NPT	5/16" = 7.9 mm	2
GS31155	3/8" NPT	3/8" = 9.5 mm	2
GS31156	3/8" NPT	5/16" = 7.9 mm	2
GS31157	3/8" NPT	1/4" = 6.4 mm	2



REF	Thread	Size	Qty
GS31066	1/4" NPT	5/16" = 7.9 mm	2
GS31067	1/4" NPT	3/8" = 9.5 mm	2



**GOLDENSHIP**

**LLAVES PARA FILTRO**      **FILTER KEY**      **CHIAVE DA FILTRO**      **CLÉ À FILTRE**

REF  
RACRK22628  
**RACOR**



REF  
REC70720      65 - 110 mm  
**RECMAR**



**FILTRO COMBUSTIBLE PARA MONTAJE EN LINEA**      **IN-LINE FUEL FILTER**      **FILTRO BENZINA PER MONTARE IN LINEA**      **FILTRE A ESSENCE EN LIGNE**

REF	Flow	Size	Material	Qty
GS31001	50 l/h	6-8 mm	plástico / plastic / plastica / plastique	1
GS31002	150 l/h	8-10 mm	plástico / plastic / plastica / plastique	1



**GOLDENSHIP**

REF	OEM
PAF15-07080000	3AC-02230-0 3AD-02230-0 3B7-02230-0

MFS25  
MFS25B  
MFS30



new

REF			
GS30435	6, 8, 10 mm	metal + cristal metal + crystal metallo + cristallo métal + verre	1



**GOLDENSHIP**

REF	OEM
REC35-80365M	
	6 (1989, 1992-99) 8 (1989-99, 2001-02) F4 (1999-02) F9.9 (1989-95, 1997-99, 2001-02) FT 9.9 (1988-90)



REF	OEM			
REC40145	40145	1/4"	1/4"	plástico
REC40155	40155	5/16"	5/16"	plastic
REC40165	40165	3/8"	3/8"	plastica
REC40135	40135	5/16"	3/8"	plastique



REF	OEM
PAF4-05000300	346-02230-0 366-02230-0
	M5 MFS4 M9.8 MFS5 M9.9 MFS6 M15 MFS8 M18 MFS9.9 M40 MFS15 MFS20 MFS30



REF	OEM
REC16911-ZZ5-003	HZZ5-16911-003
	BFTW60A BFT60A



**new**

REF	OEM
REC16911-ZY3-010	HZY3-16911-010
	BFT75AK1 BFT90AK1 BFT115A BFT250A BFT225A BFT200A BFT150A



**new**

**ACEITE OIL OLIO HUILES**

REF			
REC2TU6	1 L	6	2 STROKES
REC2TU3	5 L	3	TC-W3
REC5W40U6	1 L	6	SAE 5W40
REC5W40U3	5 L	3	
REC10W30U6	1 L	6	SAE 10W30
REC10W30U3	5 L	3	
REC10W40U6	1 L	6	SAE 10W40
REC10W40U3	5 L	3	
REC25W40U3	5 L	3	SAE 25W40
REC80W90U3	5 L	3	SAE 80W90
REC80W90U6	1 L	6	



REF			
RM92-858026QB1U6	1 L	6	2 STROKES
RM92-858027QB1U3	3,8 L	3	
RM92-8M0086220U6	1 L	6	SAE 10W30
RM92-8M0086221U3	4 L	3	



RM92-858026QB1U6 RM92-858027QB1U3 RM92-8M0086220U6 RM92-8M0086221U3

**TOHATSU**

**RECAMBIOS MARINOS**

FILTRO DE ACEITE

OIL FILTER

FILTRO OLIO

FILTRE À HUILE

REF	OEM	4T STROKES
REC5GH-13440-00	3R3R76150M 3RO-07615-0 5GH-13440-00	✓

 MFS15  
 MFS20  
 MFS20  
 MFS30  
 MFS40  
 MFS50  
 MFS60



REF	OEM
REC15400-PLM-A01PE	HPLM-15400-A0 HPLM-15400-PE

 BFT75AK1  
 BFT90AK1  
 BFT225A  
 BFT250A  
 BFT200A  
 BFT150A  
 BFT115A

**new**



BOMBA DE COMBUSTIBLE

FUEL PUMP

POMPA BENZINA

POMPE À ESSENCE

MEMBRANAS Y JUNTAS

DIAPHRAGMS & GASKETS

MEMBRANA E GUARNIZIONI

MEMBRANES ET JOINTS

REF	OEM
REC8537312	350-04005-0

 M9.9D2  
 M15D2  
 M18E2  
 M40D2  
 M50D2

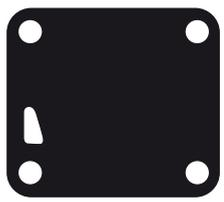

REF	OEM
REC27-8555691	3C8-04028-0

 M9.9D2  
 M15D2  
 M18E2  
 M40D2  
 M50D2

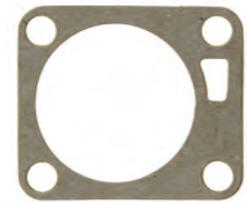

REF A	OEM
REC16275	369-03303-0

 M4C  
 M5B  
 M5BS  
 M6B  
 M8B  
 M9.8B



REF	OEM
REC27-16274	369-03302-0

 M4C  
 M5B  
 M5BS  
 M6B  
 M8B  
 M9.8B

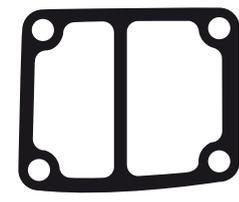

REF B	OEM
REC16325	369-03306-0

 M4C  
 M5B  
 M5BS  
 M6B  
 M8B  
 M9.8B



REF	OEM
REC27-16326	369-03307-0

 M4C  
 M5B  
 M5BS  
 M6B  
 M8B  
 M9.8B

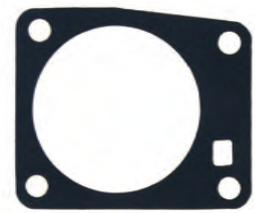

CARBURADOR

CARBURATOR

CARBURATORE

CARBURATEUR

CARBURADOR COMPLETO

FULL CARBURATOR

CARBURATORE COMPLETO

CARBURATEUR COMPLET

REF	OEM	4T STROKES
PAF8-05040000	3F5-03100-0 3V2-03100-2	✓

 MFS8  
 MFS9.8HP



TOHATSU

RECAMBIOS MARINOS

**KITS CARBURADORES**

**CARBURETOR KITS**

**KIT CARBURATORI**

**KIT CARBURATEUR**

REF	OEM
REC6H3-W0093-02	346-87122-0
 45A2	
 50C	
 60C	
 70A2	
 M25C3	
 M30A4	



REF	OEM
REC6G1-W0093-00	369-87122-1 3B2-87122-0
 5B	M5
 8B	M6
 9.8	M8
 M4	M9.8



REF	OEM
REC6H4-W0093-03	3F3-87122-1
 M70	



**new**

REF	OEM
REC66M-W0093-01	3V1-87122-0
 MFS8	
 MFS9	



**new**

REF	OEM
REC6H1-W0093-01-00	346-87122-0
 M25	
 M30	



**new**

REF	OEM
REC696-W0093-00	345-87122-4
 C2	
 M40	



**new**

REF	OEM
REC6A1-W0093-01	3F0-87122-2
 M2.5	
 M3.5	



**new**

**KITS 2 CARBURADORES**

**KITS FOR 2 CARBURETORS**

**KIT 2 CARBURATORI**

**KIT 2 CARBURATEURS**

REF	OEM
REC84419M	345-87122-0
 M35C	
 M40C	



REF	OEM
REC6L2-W0093-00	3C8-87122-2 3G2-87122-2
 M50	
 M15	
 M18	



**new**

**BOYAS**

**FLOATS**

**GALLEGGIANTE**

**FLOTTEUR DE CARBURATEUR**

REF	OEM
REC162532	3C8-03125-0
 M9.9D2	M50D2
 M15D2	MF8, 9.8A-A2-A3
 M18W2	MFS15C
 M40D2	MFS20C



REF	OEM
REC16253	369-03231-0
 M4B	M8B
 M5B	M9.8B
 M5BS	
 M6B	



# SISTEMA ELÉCTRICO ELECTRIC SYSTEM

# SISTEMA ELETTRICO SYSTEME ÉLECTRIQUE

## SENSORES

## SENSORS

## SENSORE

## CAPTEURS

### SENSOR PRESIÓN DE ACEITE

### OIL PRESURE SENSOR

### SENSORE PRESIONE OLIO

### CAPTEUR PRESION HUILE

REF	OEM
PAF15-07010100	3H6-07611-0
 MFS4 --> MFS40 HP	



### SENSOR DE OXÍGENO

### OXYGEN SENSOR

### SENSORE OSSIGENO

### SONDE À OXYGENE

REF	OEM
REC35668-ZY6-003	HZY6-35668-003
 BFT150A BFT115A	



### SENSOR POSICIÓN ÁRBOL DE LEVAS

### CAMSHAFT SENSOR

### SENSORE ALBERO A CAME

### CAPTEUR DE POSITION D'ARBRE A CAMES

REF	OEM
REC37510-PNB-003	HPNB-37510-003
 BFT150A BFT115A	



## BOBINAS

## COILS

## BOBINE

## BOBINES

### BOBINA

### COIL

### BOBINA

### BOBINE

REF	OEM
PAF8-05000300	3AA-06021-0
 MFS8 MFS9.8	



REF	OEM
REC3G3-06021-1	3G3-06021-1
 M9.9D2 M15D2 M18E2 M25C3 M30A4	



REF	OEM
REC369-06021-0	369-06021-0
 M4C M5B-BS	



TOHATSU

RECAMBIOS MARINOS



**BOBINA ENCENDIDO****STARTER COIL****BOBINA AVVIAMENTO****BOBINE DEMARREUR**

REF	OEM
PAF8-05000500	3V1-06040-0 3V1060400 3V1060400M

**BOBINA DE PULSACIÓN****PULSER COIL****BOBINA ACCENSIONE****BOBINE PULSEUR**

REF	OEM
PAF8-05000200	3V1-06071-0

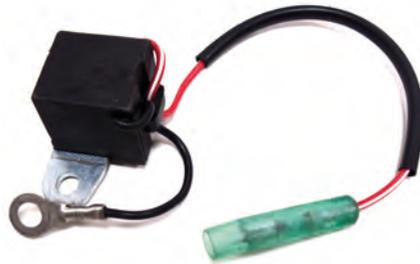
**BOBINA DE IGNICIÓN****COIL IGNITION****BOBINA AVVIAMENTO****BOBINE D'ALLUMAGE**

REF	OEM
REC3A0-06040-1	3A0-06040-1



REF	OEM
REC3G2-06040-2	3G2-06040-2



REF	OEM
REC30580-ZV4-013	HZV4-30580-013

BFT75AKI  
BFT90AKI

*new*

**BOBINA DE CARGA****CHARGER COIL****BOBINA DI CARICA****BOBINE DE CHARGE**

REF	OEM
PAF8-05090000W	3V1-06023-0



# BUJÍAS

# SPARK

# CANDELE

# BOUGIES

2T STROKES	REF NGK	RO / OEM
M2.5/ M3.5/ 3/ 5B2	NGKBPR6HS-10	9701-1-1013
M4/ M5/ M6/ M8/ M9.8	NGKBPR7HS-10	9701-1-1014
M9.9/ M25/ M30/ 40D2	NGKBR7HS-10	9701-1-1015
MX40/ 50D3	NGKB8HS-10	9701-1-1006
MC4 through 9.8B, MX15/ 18E2	NGKBP7HS-10	9701-1-1010
M25/ 30H/ MX25	NGKB7HS-10	9701-1-1005
M50D2 Through 140A2	NGKBR8HS-10	9701-1-1110

4T STROKES	REF NGK	RO / OEM
MFS2.5 Through 30C	NGKDCPR6E	9701-1-1103
MD30/ MD40/ MD50/ MD75/ MD90	NGKIZFR6	9701-1-1111
MFS40/ 50A (Serial 046502AE +)	NGKIKR6G8	9701-1-1121
MD115A2 (TLDI)	NGKIZFR5J	9791-1-1109
BFT60A	NGKLMAR6C-9	HZZ3-31909-003



2T STROKES	REF CHAMPION
M3.5A / B	CHAL87YCC
M5B / BS	CHAL82YC
M6B	CHAL82YC
M8A / B 2Cil.	CHAL82YC
M9.9B2 / C 2Cil.	CHAL82C
B18C / D	CHAL86C
M12B	CHAL82C
M15A / B2 2Cil.	CHAL82C
M15C / D	CHAL82C
M16	CHAL82C
M18A / C2 2Cil.	CHAL82C
M18D / E	CHAL82C
M20	CHAL82C

2T STROKES	REF CHAMPION
B40A	CHAL86C
B30C	CHAL86C
M25C / C2 2Cil.	CHAL82C
M30A / A3 2Cil.	CHAL82C
M35A	CHAL82YC
M40C 2Cil.	CHAL82YC
M40D 3Cil.	CHAL82YC
M50C / D 3Cil.	CHAL78C
M70A / A2 3Cil.	CHAL78C
M70B	CHAL78C
M90A 3Cil.	CHAL78C
M115A 4Cil.	CHAL78C
M140A 4Cil.	CHAL78C

4T STROKES	REF CHAMPION
MFS4	OHV CHARA8HC
MFS5A	OHV CHARA8HC
MFS5C	OHV CHARA8HC
MFS9.9A	OHV CHARA8HC
MFS15A	OHV CHARA8HC



# MOTORES DE ARRANQUE

# STARTERS

# MOTORINI AVVIAMENTO

# DÉMARREURS

## MOTORES DE ARRANQUE STARTERS

REF	OEM	⚡	☀️	2T STROKES	4T STROKES
PH130-0006	3C8-76010-1 3C8760101 3C8760101M	12V	0.6 kw	9 CCW	✓ ✓

- M40D2/B2
- M50D2/B2
- M70C
- MFS9.9B2-C
- MFS15B2-C
- MFS18B2
- MFS20C
- MFS25A-B
- MFS30B



## MOTORINI AVVIAMENTO DÉMARREURS

REF	OEM	⚡	☀️	2T STROKES	4T STROKES
PH130-0061	350-76010-0 3AA760100			✓	✓

- M15D2
- M18E2
- M8B
- M9.8B
- M9.9D2
- MFS8A2
- MFS9.8A2



REF	OEM	⚡	☀️	2T STROKES	4T STROKES
PH130-0048	353-76010-4		9	✓	

- MD70B
- MD90B
- MD115A-A2
- MD120A2
- MD140A2



REF	OEM	⚡	☀️	2T STROKES	4T STROKES
PH130-0080	346-76010-0, 346-76010-0A0 346-76010-0M			✓	

- M25C3
- M30A4
- M40C



TOHATSU

RECAMBIOS MARINOS

**new**

REF	OEM	⚡	☀️	2T	4T
				STROKES	STROKES
REC31200-ZY6-003	HZY6-31200-003				✓

 BFT150A  
 BFT115A



**new**

REF	OEM	⚡	☀️	2T	4T
				STROKES	STROKES
PH130-0070	HZY3-31200-003				✓

 BFT250A  
 BFT225A  
 BFT200A



**CDI Y CAJAS NEGRAS**

**CDI & POWER PACK**

**CDI E CENTRALINA**

**CDI ET BOITIER ELECTRONIQUE**

REF	OEM
REC3F0-06060-0	3F0-06060-0

 M2.5A2  
 B3.5A2-B2



REF	OEM
REC353-06260-0	353-06260-2 353-06260-0

 45A2  
 55B  
 60A  
 75A2



REF	OEM
REC3G2-06060-2	3G2-06060-2

 M9.9D2  
 B15D2  
 M18E2



REF	OEM
REC3A106-2602M	3A106-2402M 3A106-2601M 3A106-2602M

 25C2  
 30A3  
 40C



REF	OEM
PAF8-05000400	3AA-06060-00 3AA060600M

 MFS8  
 BFS9.8



# TRIM, TILT & POWER TRIM

## INSTALACIÓN ELÉCTRICA

## WIRING HARNESS

## INSTALLAZIONE ELETTRICA

## INSTALLATION ELECTRIQUE

### KIT CONVERSIÓN

Sustituye de 2 a 3 cables.

### CONVERSION KIT

Converts 3-wire Tilt and Trim motors to 2-Wire design

### KIT CONVERSIONE

Sustituisce da 2 a 3 cavi.

### KIT DE CONVERSION.

Passa un faisceau de 2 à 3 fils



REF

PH200-WH01

## TRIM COMPLETO

## COMPLETE TRIM ASSEMBLY

## MOTORINO TRIM COMPLETO

## MOTEUR DE TRIM

REF	OEM	⚡	🔩	🔧	2T STROKES	4T STROKES
PH200-T024		12V	3	2	✓	

V4, V6 (1990-03)



## POWER TRIM COMPLETO

## COMPLETE POWER TRIM ASSEMBLY

## MOTORINO POWER TRIM COMPLETO

## POWER TRIM COMPLET

REF	2T STROKES	4T STROKES
REC18-6865	✓	✓

3 RAM  
115-225HP  
SHOWA SYSTEM



# SISTEMA DE GOBIERNO STEERING SYSTEM

# SISTEMA DI GUIDA SYSTÈME DE COMMANDE

COMPONENTES	COMPONENTS	COMPONENTI	COMPOSANT				
CABLE DE ACELERADOR	THROTTLE CABLE	CAVO ACCELERATORE	CÂBLE D'ACCELERATEUR				
<table border="1"> <thead> <tr> <th>REF</th> <th>OEM</th> </tr> </thead> <tbody> <tr> <td>REC804898</td> <td>3B2-63600-1</td> </tr> </tbody> </table>  <p>M6B M8B M9.8B</p>	REF	OEM	REC804898	3B2-63600-1			
REF	OEM						
REC804898	3B2-63600-1						

# SISTEMA DE REFRIGERACIÓN COOLING SYSTEM

# SISTEMA DI RAFFREDDAMENTO SYSTÈME DE REFRROIDISSEMENT

TERMOSTATO	THERMOSTAT	TERMOSTATO	THERMOSTAT												
TERMOSTATO	THERMOSTAT	TERMOSTATO	THERMOSTAT												
<table border="1"> <thead> <tr> <th>REF</th> <th>OEM</th> <th>°C</th> </tr> </thead> <tbody> <tr> <td>REC855676002</td> <td>3R3-01030-0</td> <td>60°</td> </tr> </tbody> </table>  <p>MFS8 MFS30</p>	REF	OEM	°C	REC855676002	3R3-01030-0	60°		<table border="1"> <thead> <tr> <th>REF</th> <th>OEM</th> <th>°C</th> </tr> </thead> <tbody> <tr> <td>REC19300-ZV5-043</td> <td>HZV5-19300-043</td> <td></td> </tr> </tbody> </table>  <p>BFT115A BFT130A BFT150A</p>	REF	OEM	°C	REC19300-ZV5-043	HZV5-19300-043		
REF	OEM	°C													
REC855676002	3R3-01030-0	60°													
REF	OEM	°C													
REC19300-ZV5-043	HZV5-19300-043														
<table border="1"> <thead> <tr> <th>REF</th> <th>OEM</th> <th>°C</th> </tr> </thead> <tbody> <tr> <td>PAF15-07000031</td> <td>HZW9-19300-003</td> <td></td> </tr> </tbody> </table>  <p>BFT90AK1 BFT75AK1 BFT60A BFTW60A</p>	REF	OEM	°C	PAF15-07000031	HZW9-19300-003										
REF	OEM	°C													
PAF15-07000031	HZW9-19300-003														

**JUNTA TERMOSTATO**

**THERMOSTAT, GASKET BASE**

**GUARNIZIONE TERMOSTATO**

**JOINT DE THERMOSTAT**

REF	OEM
REC3T9-01032-0	3T9-01032-0

MD75C2  
MD70B / C2  
MD90D / C2



**JUNTAS TAPA DE REFRIGERACIÓN**

**GASKETS EXHAUST INNER COVER**

**GUARNIZIONE COPERCHIO REFRIGERAZIONE**

**JOINT DE COUVERCLE DE REFRIGERANT**

REF	OEM
REC3F3-02305-1	3F3-02305-1

M60C  
M70C

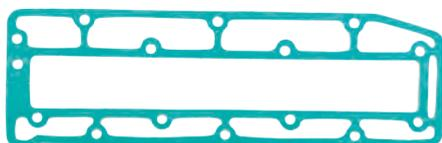

REF	OEM
REC3B7-02305-1	3B7-02305-1

MD70B  
MD90D



**IMPULSORES**

**IMPELLERS**

**GIRANTE**

**TURBINES**

**GUÍA DE IMPULSORES**

**IMPELLER GUIDE**

**GUIDA GIRANTE**

**GUIDE DES TURBINES**

2T STROKES	REF	OEM	CEF	A (mm)	B (mm)	C (mm)
2 / 2.5HP		369-65021-1	CEF500377	10,25	33,6	14,3
2.5A/3.5A/3.5B		309-65021-1	CEF500396	12	41	14
3.5 / 4 / 5 HP		369-65021-1	CEF500377	10,25	33,6	14,3
6 / 8 / 9.8 HP	REC3B2-65021-1	3B2-65021-1	CEF500344	12,1	40	18
9.9 / 15 / 18 HP		334-65021-0	CEF500383	13,96	40,7	23,35
25 / 30 / 35 HP	REC345-65021-0	345-65021-0	CEF500382	17,12	44,1	20,25
40 / 50 HP		345-65021-1	CEF500379	17,2	50,4	20,15
60 / 70 / 90 HP	REC3B7-65021-2	3B7-65021-2	CEF500388	20,15	67,4	35,1
115 / 120 / 140 HP		3C7-65021-1	CEF500388	20,15	-67,4	35,1

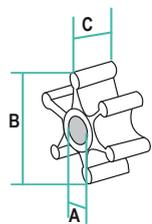

4T STROKES	REF	OEM	CEF	A (mm)	B (mm)	C (mm)
MFS4, 5, 6HP		369-65021-1	CEF500377	10,25	33,6	14,3
MFS8, 9.8 HP	REC3B2-65021-1	3B2-65021-1	CEF500344	12,1	40	18
MFS9.9, 15, 18HP		334-65021-0	CEF500383	13,96	40,7	23,35
20HP		334-65021-0	CEF500383	13,96	40,7	23,35
MFS25, 30HP	REC345-65021-0	345-65021-0	CEF500382	17,12	44,1	20,25
BFTW60A BT60A	REC19210-ZV5-003	HZV5-19210-003	CEF500338	17,20	55,90	20,20
BFT115A / 150A	REC19210-ZW1-B02	HZW1-19210-B04	CEF500337	23,35	87,80	31,00
BFT200A / 225A BFT250A	REC19210-ZY3-003	HZY3-19210-003	CEF500391	26	89,75	31,30



REC345-65021-0



REC3B2-65021-1



REC19210-ZY3-003



REC19210-ZV5-003



REC19210-ZW1-B02



REC3B7-65021-2

**BOMBA DE AGUA**

**WATER PUMP**

**POMPA ACQUA**

**POMPE À EAU**

**JUNTA BASE DE BOMBA**

**WATER PUMP, GASKET BASE**

**GUARNIZIONE BASE POMPA**

**JOINT, BASE DE POMPE À EAU**

REF	OEM
PAF8-04000007	3B2-65025-0
 MD9.9D2 MD15D2 MD18E2	MFS9.9B2-C MFS15C MFS18B2 MFS20C



REF	OEM
REC16159	369-65025-0
 MFS4A2-B-C MFS5A2-B-C MFSA2-B-C	



**JUNTAS BOMBA**

**WATER PUMP GASKET**

**GUARNIZIONE POMPA**

**JOINTS DE POMPE**

REF	OEM
REC3F0-65029-0	3F0-65029-6
 M3.2B2 MFS2.5B MFS3.5B MFS2A	



**CASQUILLO INOX**

**INSERT CUP**

**GHIERA INOX**

**INSERT INOX**

REF	OEM
REC803751	350-65011-1
 M9.9D2 M15D2 M18E2 MFS9.9C, B2 MSF15C, B2 MSF20C MSF18B2	



REF	OEM
PAF8-04000010	3B2-65011-0
 M6 M8 M9.8B MFS8, A - A2 -A3 MFS9.8A - A2 -A3	



REF	OEM
REC16157	369-65011-0
 M4B M5B M5B5 MFS4, 5, 6 -A2	



**KITS DE REPARACIÓN BOMBA DE AGUA**

**WATER PUMP SERVICE KITS**

**KIT RICAMBI POMPA ACQUA**

**KIT POMPE À EAU**

**new**

REF	OEM
REC06192-ZY6-000	HZY6-06192-000
 BFT150 BFT115A	

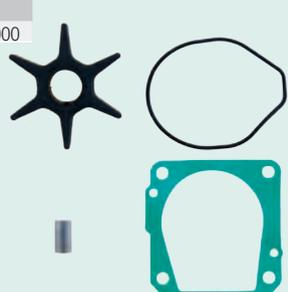

**new**

REF	OEM
REC06192-ZY3-000	HZY3-06192-000
 BFT200A BFT225A	

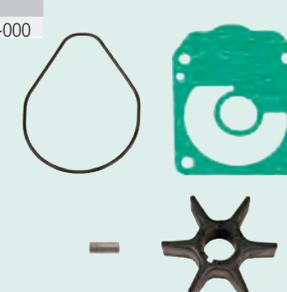



# ÁNODO

# ANODE

# ANODI

# ANODE

ZN	KG (KG)	AL	KG (KG)	OEM
CM3C760-2181	0,51	CM3C760-2181A	0,21	3C7760-2181

60, 70, 90, 120, 140 HP

ZN	KG (KG)	OEM
CM3B7-60218-0	0,51	3B7-60218-1

Serie MEGA

ZN	KG (KG)	AL	KG (KG)	OEM
CM5338602182A0	0,21	CM5338602182A0A	0,08	5338602182A0

ZN	KG (KG)	AL	KG (KG)	OEM
CM3H6-60218-000	0,03	CM3H6-60218-000A	0,01	3H6-60218-0

ZN	KG (KG)	OEM
CM3M2-60218-1	0,05	3M2-60218-0

40, 140 HP

ZN	KG (KG)	OEM
CM33860-2181	0,10	338-60218-2

2,5, 3,5, 5, 6, 8 HP  
15, 18, -S MAXI 25, 40  
CORSA

ZN	KG (KG)	AL	KG (KG)	OEM
CM3V1-60217-0	0,10	CM3V1-60217-0A	0,04	3V1602170

ZN	KG (KG)	OEM
CM348-60217-0M	0,12	348-60217-0

Serie MAXI CORSA  
25-40 HP

ZN	KG (KG)	OEM
CM3C8-60217-0	0,15	3C8-60217-1

Serie MEGA  
25-50 HP

ZN	KG (KG)	OEM
CM3B7-602170	0,15	3B7-60217-0

60, 70, 90, 120, 140 HP



ÁNODO

ANODE

ANODI

ANODE

ZN	KG (KG)	OEM
TEN01254	0,51	3C7-60218-2

☛ Serie 60 - 70 - 90 - 120 - 140 - 150 HP



ZN	KG (KG)	OEM
TEN01253	0,150	3C8-60217-1

☛ Serie MEGA 25 - 50 HP



ZN	KG (KG)	OEM
TEN01256	0,040	3B7-60218-1

☛ Serie MEGA



ZN	KG (KG)	OEM
TEN01252	0,120	348-60217-0

☛ Serie MAXI CORSA 25 - 40 HP



ZN	KG (KG)	OEM	Ø
TEN01250	0,010	338-60218-2	20 mm
TEN01251	0,020	369-60218-1	24 mm

☛ Serie 2.5, 3.5, 5, 6, 8 HP  
15 - 18-S MAXI-25 - 40 CORSA



ZN	KG (KG)	OEM
TEN01255	0,320	3B7-60217-0

☛ Serie 60 - 70 - 90 - 120 - 140 HP



ZN	KG (KG)	OEM
TEN01257	0,050	3M2-60218-0

☛ Serie 40 - 140 HP



ZN	KG (KG)	OEM
TEN01408	0,320	HZV4-12155-A00

☛ BFTW60A  
BFT60A  
BFT200A  
BFT250A  
BFT225A



new

ZN	KG (KG)	OEM
TEN01258	0,020	5338602182A0

☛ Serie 40 - 140 HP



ZN	KG (KG)	OEM
TEN01259	0,030	3H6-60218-0



ZN	KG (KG)	OEM
TEN01408/1	0,320	HZV5-12155-000

☛ BFT60A  
BFT75AK1  
BFT90AK1  
BFT150A  
BFT200A  
BFT250A  
BFT225A  
BFT115A



new

ZN	KG (KG)	OEM
TEN01260	0,150	3B7-60217-0

☛ Serie 140 HP



# PARTES DEL MOTOR ENGINE PARTS

# PARTI MOTORE PIECES MOTEUR

DESPIECE MOTOR  
DE 2 TIEMPOS

ENGINE PARTS  
2 STROKES

PARTI MOTORI  
2 TEMPI

PIECES DE MOTEURS  
2 TEMPS

2T M4C • M5B • M5BS  
STROKES

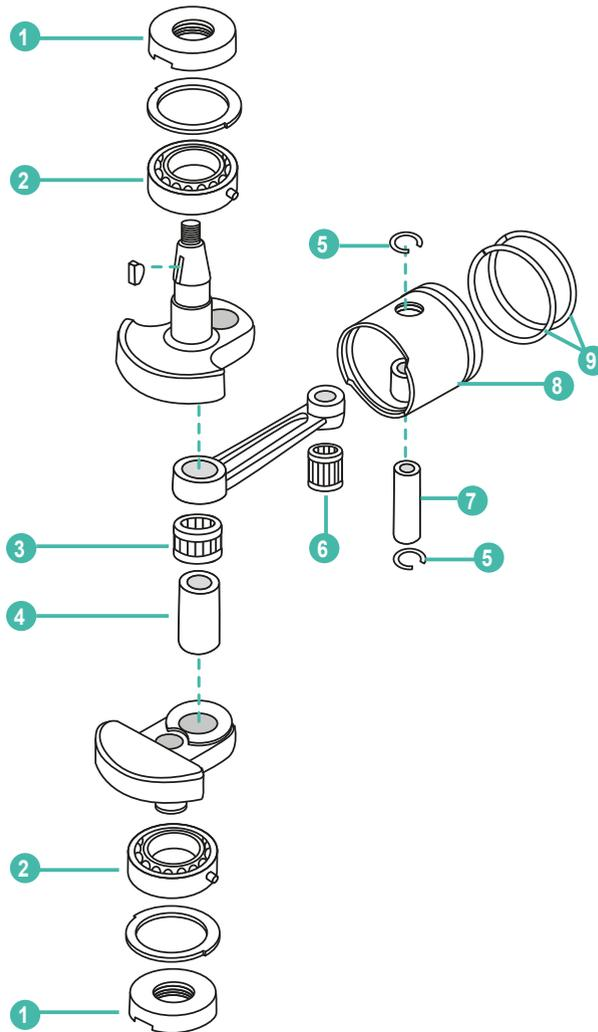

	REF	OEM					UN.
1	REC26-16051	369-00122-0	RETÉN ACEITE	OIL SEAL	PARALIO	JOINT SPI	2
2	REC30-16049	9603-3-6204	RODAMIENTO	BALL BEARING	CUSCINETTO	ROULEMENT	2
3	REC31-813048	369-00043-0	COJINETE DE AGUJA	NEEDLE BEARING	CUSCINETTO	ROULEMENT	1
4	REC813046002	369-00061-0	PIN	CRANK PIN	SPINOTTO	PIN	1
5	REC53-16057	350-00024-1	CLIP	CLIP	CLIP	CLIP	2
6	REC31-16052	350-00042-0	COJINETE DE AGUJA	NEEDLE BEARING	CUSCINETTO	ROULEMENT	1
7	REC41-16056	369-00021-0	PIN	PISTON PIN	SPINOTTO	AXE DE PISTON	1
8	REC779-9615T	369-00001-0	PISTÓN STD	PISTON STD	PISTONE STD	PISTON STD	1
9	REC8M0080357	351-00011-0	KIT SEGMENTOS	PISTON RING KIT	KIT FASCIA	KIT DE SEGMENTS	2

TOHATSU

RECAMBIOS  
MARINOS

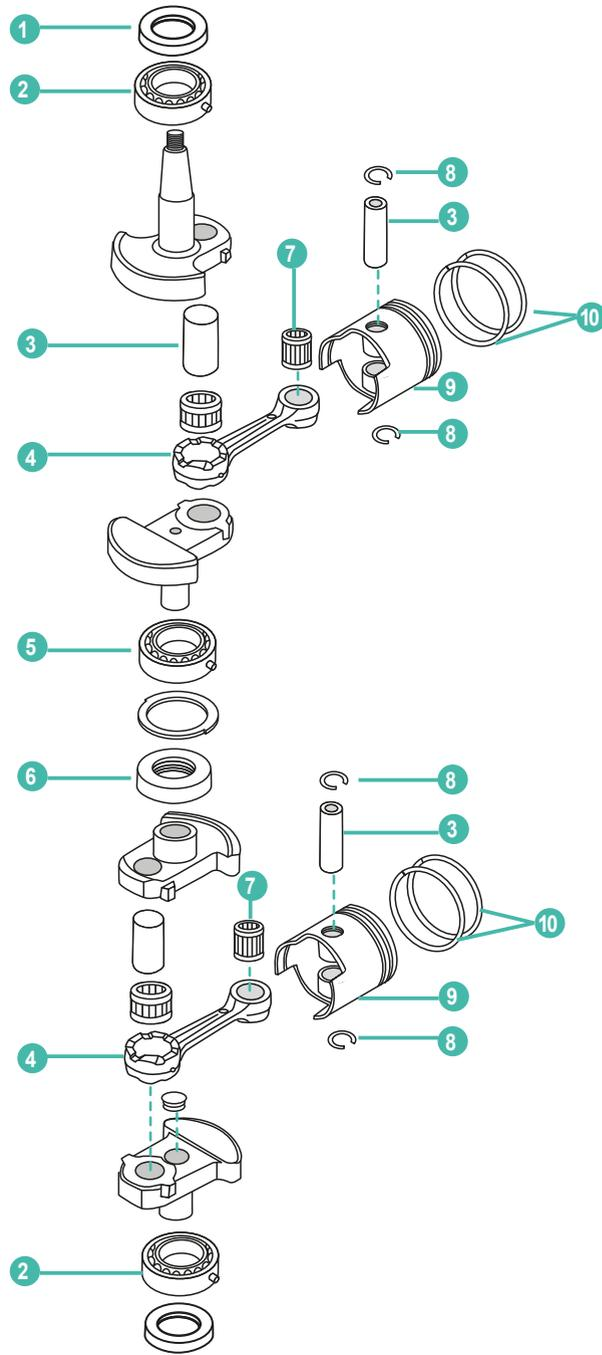

	REF	OEM					UN.
1	REC26-803514	101-00121-0	RETÉN ACEITE	OIL SEAL	PARALIO	JOINT SPI	1
2	REC30-16049	9603-3-6204	RODAMIENTO	BALL BEARING	CUSCINETTO	ROULEMENT	2
3	REC41-8036801	3B2-00021-0	PIN	PISTON PIN	SPINOTTO	AXE DE PISTON	2
4	REC629-8036741	3B2-00040-0	BIELA	CONNECTING ROD	BIELLA	BIELLE	2
5	REC30-16049	9603-3-6204	RODAMIENTO	BALL BEARING	CUSCINETTO	ROULEMENT	1
6	REC26-85370711	3B2-00051-0	RETÉN ACEITE	OIL SEAL	PARALIO	JOINT SPI	1
7	REC31-8036752	338-00042-0	COJINETE DE AGUJA	NEEDLE BEARING	CUSCINETTO	ROULEMENT	2
8	REC53-16057	350-00024-1	CLIP	CLIP	CLIP	CLIP	2
9	REC779-804886	3B2-00001-0	PISTÓN STD	PISTON STD	PISTONE STD	PISTON STD	2
10	REC39-803678A3	3B2-00011-0	KIT SEGMENTOS	PISTON RING KIT	KIT FASCIA	KIT DE SEGMENTS	4

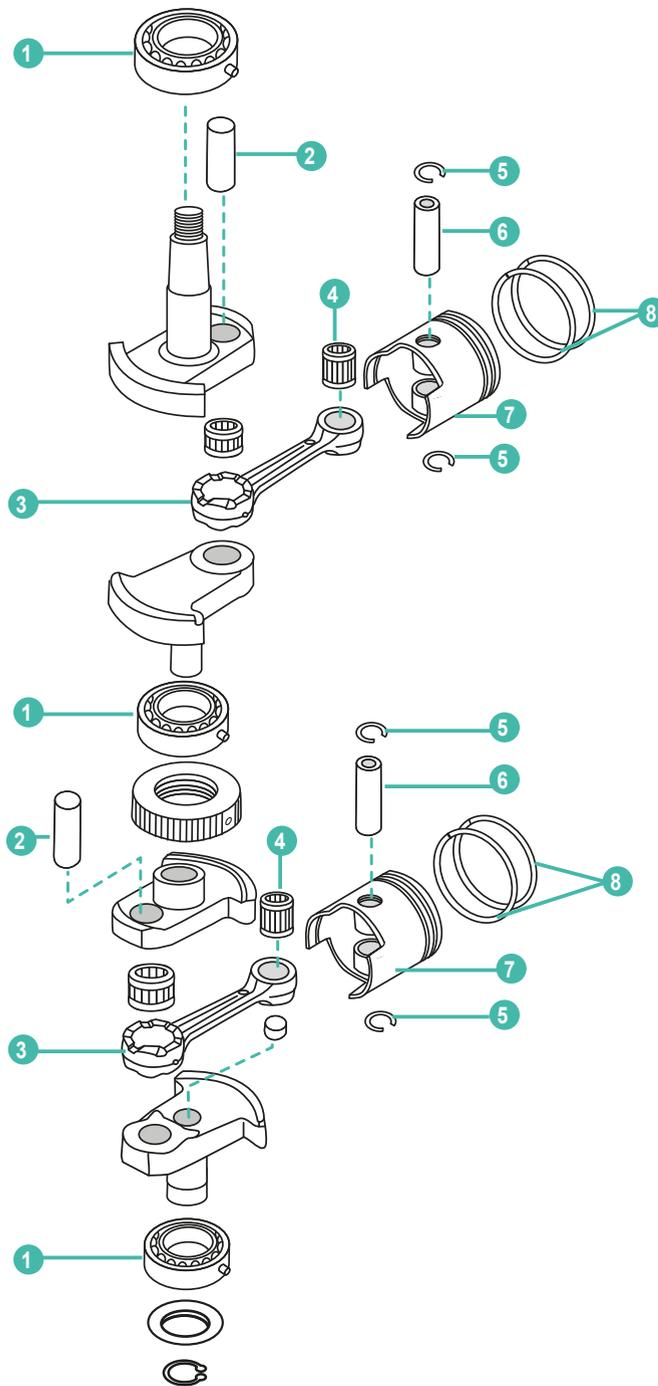

	REF	OEM				UN.	
1	REC30-160494	96603-3-6305	RODAMIENTO	BALL BEARING	CUSCINETTO	ROULEMENT	3
2	REC803673	350-00061-0	PIN	CRANK PIN	SPINOTTO	PIN	2
3	REC629-803674	350-00040-0	BIELA	CONNECTING ROD	BIELLA	BIELLE	2
4	REC31-16052	350-00042-0	COJINETE DE AGUJA	NEEDLE BEARING	CUSCINETTO	ROULEMENT	2
5	REC53-16057	350-00024-1	CLIP	CLIP	CLIP	CLIP	4
6	REC41-803680002	350-00021-0	PIN 18 HP	PISTON PIN 18 HP	SPINOTTO 18 HP	AXE DE PISTON 18 HP	2
	REC41-825713002	332-00021-0	PIN 9.9 / 15 HP	PISTON PIN 9.9 / 15 HP	SPINOTTO 9.9 / 15 HP	AXE DE PISTON 9.9 / 15 HP	2
7	REC779-803677T02	351-00001-1	PISTÓN STD, 9.9 / 15 HP	PISTON STD 9.9 / 15 HP	PISTONE STD 9.9 / 15 HP	PISTON STD 9.9 / 15 HP	1
	REC779-803677	350-00001-1	PISTÓN STD 18 HPP	PISTON STD HP	PISTONE STD 18 HP	PISTON STD 18 HP	1
8	REC39-803678A1	350-00011-0	KIT SEGMENTOS 18 HP	PISTON RING KIT 18 HP	KIT FASCIA 18 HP	KIT DE SEGMENTS 18 HP	2
	REC8M0080357	351-00011-0	KIT SEGMENTOS 9.9 / 15 HP	PISTON RING KIT 9.9 / 15 HP	KIT FASCIA 9.9 / 15 HP	KIT DE SEGMENTS 9.9 / 15 HP	2

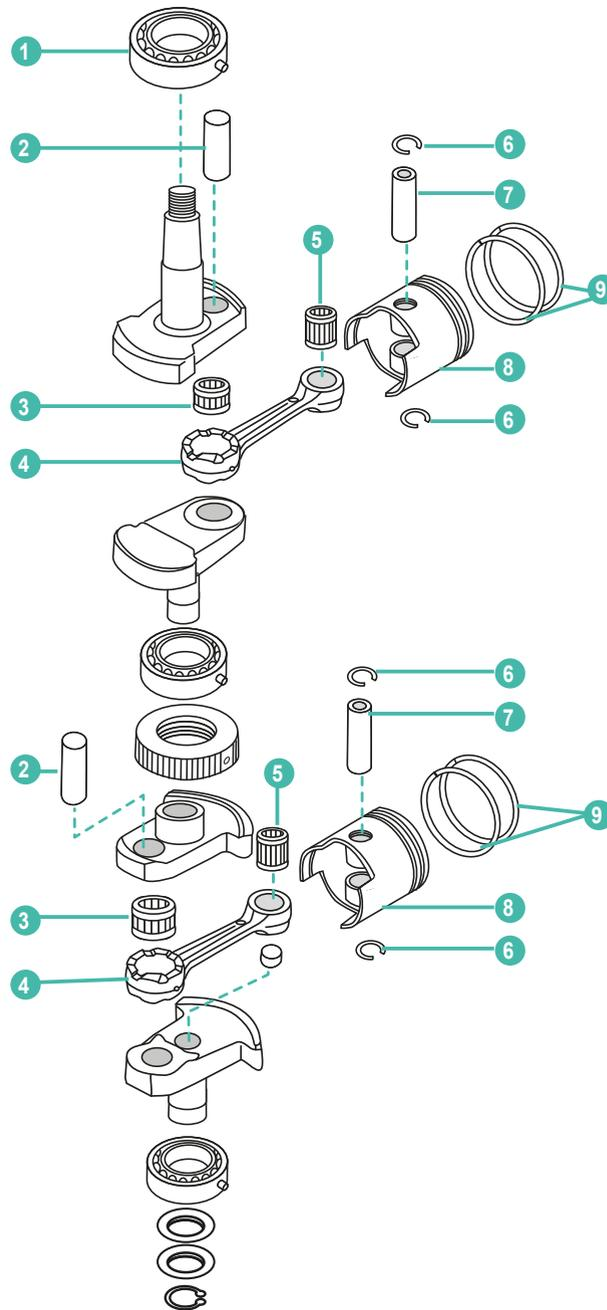

	REF	OEM					UN.
1	REC30-16049T01	345-00113-0	RODAMIENTO	BALL BEARING	CUSCINETTO	ROULEMENT	1
2	REC8130461	334-00061-0	PIN	CRANK PIN	SPINOTTO	PIN	2
3	REC31-8130482	356-00043-0	COJINETE DE AGUJA	NEEDLE BEARING	CUSCINETTO	ROULEMENT	2
4	REC629-813047T01	336-00040-1	BIELA	CONNECTING ROD	BIELLA	BIELLE	2
5	REC345-00042-0	345-00042-0	COJINETE DE AGUJA	NEEDLE BEARING	CUSCINETTO	ROULEMENT	1
6	REC53-16057	334-00024-1	CLIP	CLIP	CLIP	CLIP	4
7	REC41-803680003	3C8-00021-0	PIN	PISTON PIN	SPINOTTO	AXE DE PISTON	2
8	REC779-879194T01	346-00001-1	PISTÓN STD	PISTON STD	PISTONE STD	PISTON STD	2
9	REC39-16054A5	346-00011-0	KIT SEGMENTOS	PISTON RING KIT	KIT FASCIA	KIT DE SEGMENTS	4

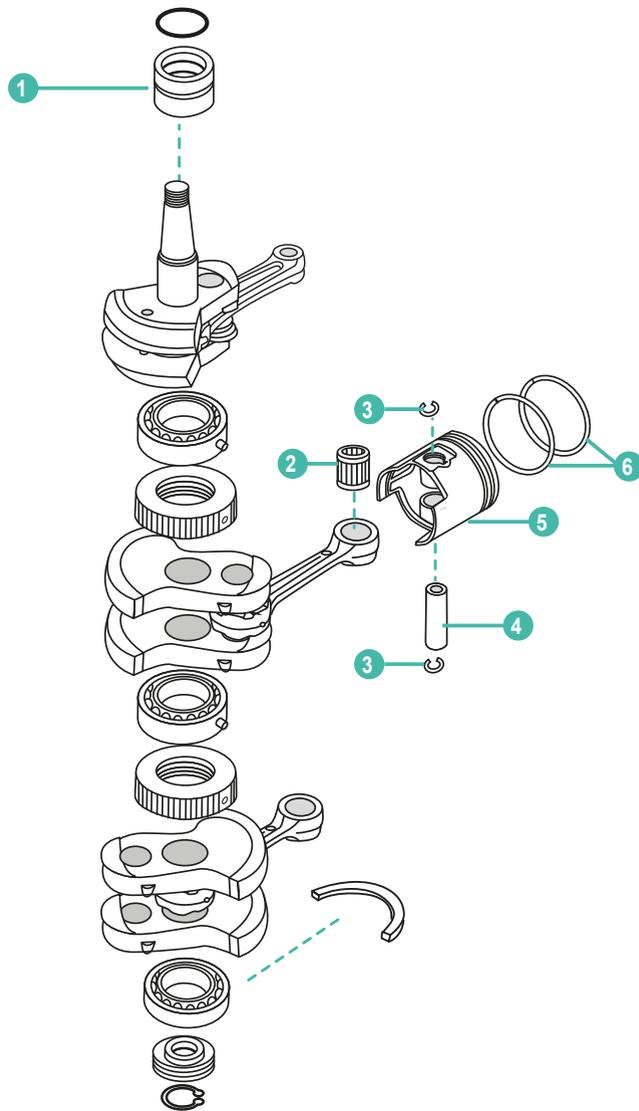

	REF	OEM					UN.
1	REC31-855553	3C8-00113-0	RODAMIENTO SUP.	MAIN BEARING UPPER	CUSCINETTO SUPERIORE	ROULEMENT SUPERIEUR	1
2	REC345-00042-0	345-00042-0	COJINETE DE AGUJA	NEEDLE BEARING	CUSCINETTO	ROULEMENT	3
3	REC53-16057	334-00024-1	CLIP	CLIP	CLIP	CLIP	6
4	REC41-16056	3C8-00021-0	PIN	PISTON PIN	SPINOTTO	AXE DE PISTON	3
5	REC779-9615T	3C8-00001-3	PISTÓN STD	PISTON STD	PISTONE STD	PISTON STD	3
6	REC8M0080349	346-00011-0	KIT SEGMENTOS	PISTON RING KIT	KIT FASCIA	KIT DE SEGMENTS	6

4T MFS8 • MFS9.9  
STROKES

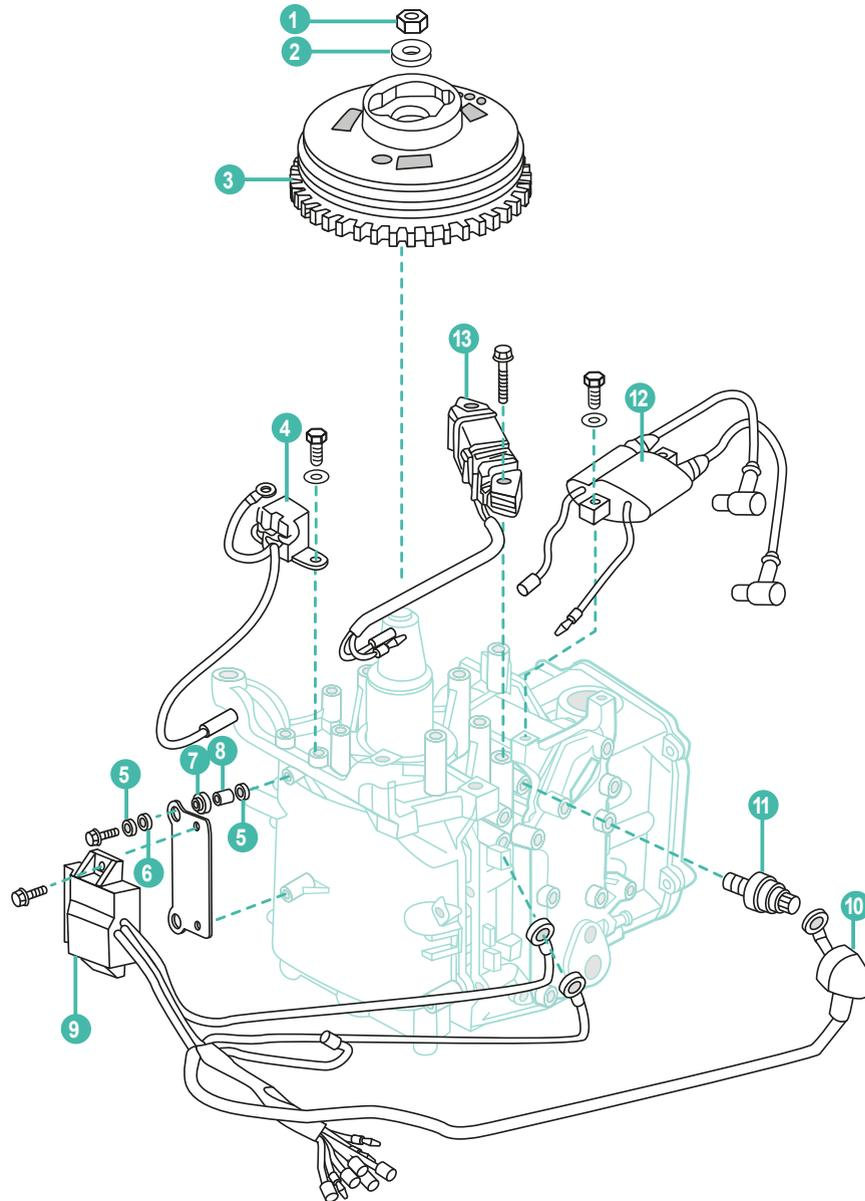

REF	OEM					
1	PAF8-05000024	369-00132-0	TUERCA	NUT, FLYWHEEL	DADO	ÉCROIU
2	PAT15-04000011	940121-1200	ARANDELA	WASHER, FLYWHEEL NUT	RONDELLA	RONDELLE
3	PAF8-050000600	3AA-06091-0	EJE DE VOLANTE	FLYWHEEL ASSY	ASSE VOLANTE	VOLANT MOTEUR
4	PAF8-050000200	3V1-06071-0	BOBINA PULSACIÓN	COIL PULSER	BOBINE ACCENSIONE	BOBINE PULSEUR
5	PAF8-050000021	3R0-66308-0	ARANDELA	WASHER	RONDELLA	RONDELLE
6	PAF8-050000007	3B7-06305-0	AMORTIGUADOR (A)	ABSORBER (A) CDI	CUSCINO (A)	SILENT BLOC (A)
7	PAF8-050000011	3T5-06920-0	AMORTIGUADOR (B)	ABSORBER (B) CDI	CUSCINO (B)	SILENT BLOC (B)
8	PAF8-050000006	3A0-76079-0	MANGUERA	TUBE	TUBO	DURITE
9	PAF8-050000400	3AA-06060-0	CDI	CDI	CDI	CDI
10	PAF15-07010101	3H6-07612-0	AISLANTE	JACKET INSULATION	ISOLANTE	ISOLANT
11	PAF15-07010100	3H6-07611-0	SENSOR PRESIÓN ACEITE	OIL PRESSURE SENSOR	SENSORE PRESSIONE OLIO	SONDE DE PRESSION D'HUILE
12	PAF8-050000500	3V1-06040-0	BOBINA ENCENDIDO	STARTER COIL ASSY	BOBINA AVVIAMENTO	BOBINE DÉMARREUR
13	PAF8-050000300	3AA-06021-0	BOBINA	COIL	BOBINE	COIL

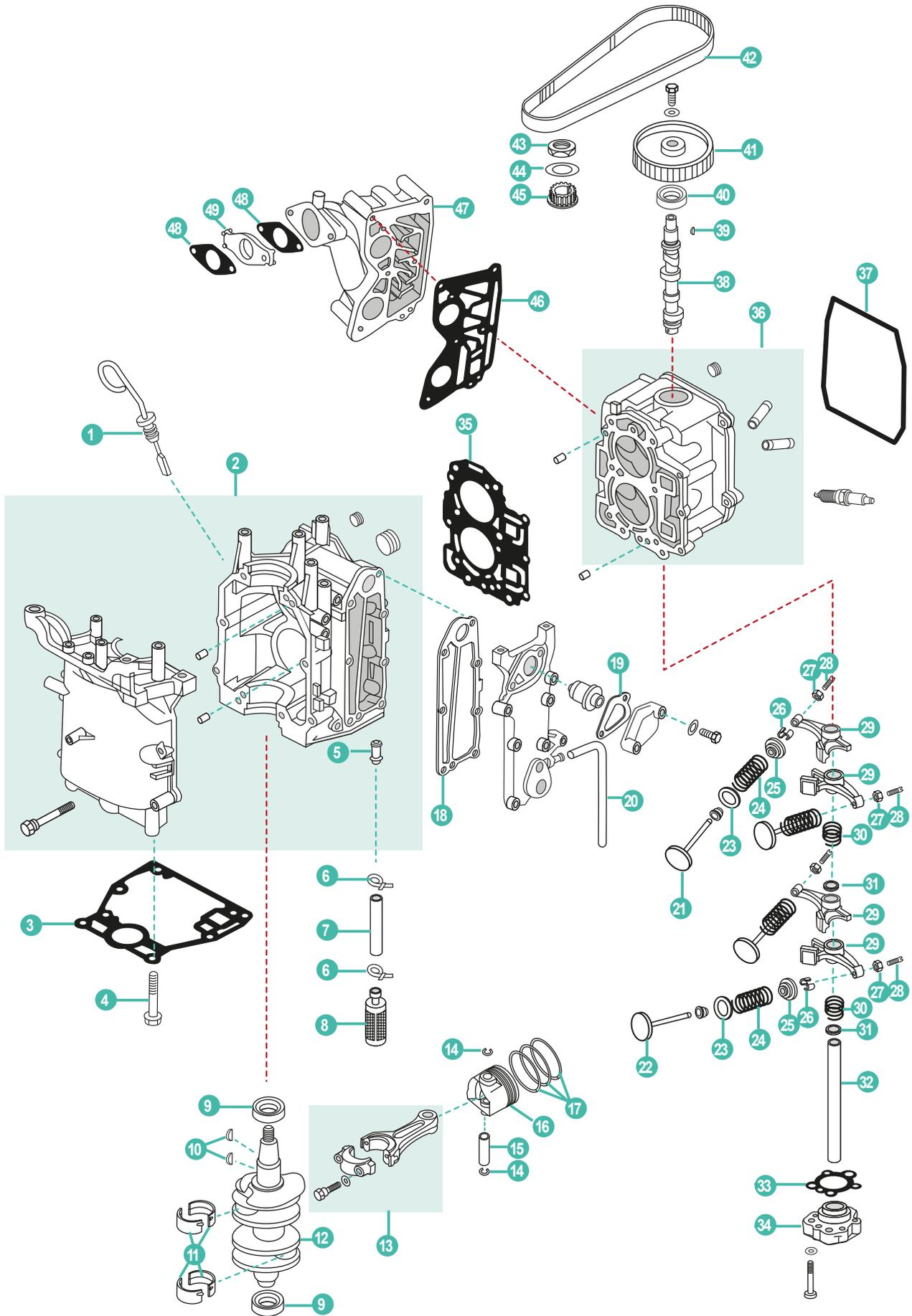



	REF	OEM				
1	PAF8-0000200	3V1-07421-0	MEDIDOR NIVEL ACEITE	OIL LEVEL GAUGE	MISURATORE LIVELLO OLIO	JAUGE D'HUILE
2	PAF8-05010000	3V1B01100-0	BLOQUE COMPLETO	CRANKCASSE ASSY	BLOCCO MOTORE	MOTEUR COMPLET
3	PAF8-00000004	3V1-01303-0	JUNTA BASE MOTOR	GASKET, ENGINE BASEMENT	GUARNIZIONE BASE MOTORE	JOINT, BASE DE MOTEUR
4	PAF8-00000003	3R3-61017-0	TORNILLO M8x35	BOLT M8x35	VITE M8x35	VIS M8x35
5	PAF8-05010002	3H8-02093-0	RACORD	NIPPLE	RACCORDO	RACORD
6	PAF8-05000025	369-84398-0	CLIP	HOOP	CLIP	CLIP
7	PAF8-05000017	98AH10-0120	MANGUERA	HOSE	TUBO	DURITE
8	PAF8-05000800	3V1-07410-0	FILTRO ACEITE	OIL STRAINER	FILTRO OLIO	FILTRE A HUILE
9	PAF8-05010012	3V1-00121-0	RETÉN ACEITE	OIL SEAL	PARAOLIO	JOINT SPI
10	PAF4-04000019	3T5-10131-0	CHAVETA	KEY	CHIAVETTA	CLAVETTE
11	PAF8-05010009	3V1-07407-0	COJINETE	BUSH	BRONZINA	ROULEMENT
12	PAF8-05020001	3V1-00030-1	CIGÜEÑAL	CRANK	ALBERO MOTORE	VILEBREQUIN
13	PAF8-05020200	3V1-00040-0	BIELA	CONNENCTING ROD	BIELLA	BIELLE
14	PAF15-07020005	350-00024-1	CLIP	CIRCLIP	CLIP	CLIP
15	PAF8-05020105	332-00021-0	PIN	PIN, PISTON	SPINNOTO	AXE DE PISTON
16	PAF8-05020101	3V1-00001-0	PISTON	PISTON	PISTONE	PISTON
17	REC39-8M0055809	3V1-00011-0	KIT SEGMENTOS	PISTON RING KIT	KIT FASCIA	KIT DE SEGMENTS
18	PAF8-05010004	3V1-02305-0	JUNTA ESCAPE	GASKET, EXHAUST COVER	GUARNIZIONE SCARICCO	JOINT D'ECHAPPEMENT
19	PAF8-05010005	346-01032-0	JUNTA TERMOSTATO	GASKET, THERMOSTAT COVER	GUARNIZIONE TERMOSTATO	JOINT DE THERMOSTAT
20	PAF8-05000024	98AB-5-0330	TUBO	WATER PIPE	TUBO	DURITE
21	PAF8-05030001	3V1-07201-0	VÁLVULA ADMISIÓN	VALVE INTAKE	VALVOLA ASPIRAZIONE	SOUPAPE D'ADMISSION
22	PAF8-05030002	3V1-07202-0	VÁLVULA ESCAPE	VALVE EXHAUST	VALVOLA SCARICO	SOUPAPE D'ECHAPPEMENT
23	PAF8-05030004	3V1-07205-0	ASIENTO MUELLE	SEAL, VALVE SPRING	SIGILLO MOLLA	SIEGE RESSORT DE SOUPAPE
24	PAF8-05030005	3AA-07203-0	MUELLE VÁLVULA	SPRING VALVE	VALVOLA MOLLA	RESSORT DE SOUPAPE
25	PAF8-05030006	3V1-07221-0	RETEN RESORTE	RETAINER, VALVE SPRINGER	VALVOLA DI RITEGNO	JOINT DE RESSORT
26	PAF8-05030007	3H6-07223-0	SEGURO DE VÁLVULA	CLAMP, VALVE	BLOCCAGGIO DI VALVOLA	CLAVETTE DE SOUPAPE
27	PAF15-07040304	3H8-07237-0	TUERCA	LOCK NUT	GHIERA	ÉCROU
28	PAF15-07040303	3R0-07238-0	TORNILLO AJUSTE	SCREW, VALVE ADJUSTING	VITE	VIS
29	PAF8-05030200	3V1-07235-0	BALANCÍN	ROCKER	BILANCERE	CULBUTEUR
30	PAF8-05030009	3AA-07225-0	MUELLE	SPRING ROCKER	MOLLA	RESSORT
31	PAF8-05030015	3R3-07227-0	ARANDELA	BUSHER, ROCKER SPRING	RONDELLA	RONDELLE
32	PAF8-005030010	3H8-07226-0	EJE	SHAFT ROCKER	ASSE	AXE DE CULBUTEUR
33	PAF8-05030012	3V1-07653-0	JUNTA BOMBA ACEITE	OIL PUMP GASKET	GUARNIZIONE POMPA OLIO	JOINT POMPE
34	PAF8-05030300	3V1-07600-0	BOMBA ACEITE	OIL PUMP	POMPA OLIO	POMPE À HUILE
35	PAF8-05000100	3V1-02305-0	JUNTA CULATA	CYLINDER HEAD GASKET	GUARNIZIONE TESTATA	JOINT DE CULASSE
36	PAF8-05030100	3V1B01001-0	CULATA	CYLINDER HEAD ASSY	TESTATA	CULASSE
37	PAF8-05000002	3V1-01024-0	JUNTA TAPA CULATA	CYLINDER HEAD COVER GASKET	GUARNIZIONE COPERCHIO TESTATA	JOINT COUVERCLE
38	PAF8-05030008	3V1-07010-0	ÁRBOL DE LEVAS	CRAMSHAFT	ALBERO MOTORE	ARBRE À CAMES
39	PAT3.6-04000006	309-00131-0	CHAVETA	KEY	CHIAVETTA	CLAVETTE
40	PAF8-05030011	3H8-07025-0	RETÉN ACEITE	OIL SEAL 18x35x7.8 mm	PARAOLIO	JOINT SPI
41	PAF8-05030400	3H8-10062-2	POLEA	DRIVER PULLEY	PULEGGIA	POULIE
42	PAF8-05000004	3V1-10045-0	CORREA	TIMING BELT	CINGHIA DI DISTRIBUZIONE	COURROIR DISTRIBUTION
43	PAF8-05010016	3V1-10068-0	TUERCA	NUT	DADO	ÉCROU
44	PAF8-05010015	3V1-10063-0	ARANDELA	BELT GUIDER	RONDELLA	RONDELLE
45	PAF8-05010014	3V1-10060-0	POLEA	DRIVER PULLEY	PULEGGIA	POULIE
46	PAF8-05000009	3V1-02104-0	JUNTA COLECTOR	GASKET MANIFOLD	GUARNIZIONE COLLETTORE	JOINT DE COLLECTEUR
47	PAF8-05000008	3V1-02010-1	COLECTOR ADMISIÓN	INTAKE MANIFOLD	COLLETTORE ASPIRAZIONE	COLLECTEUR D'ADMISSION
48	PAF15-07000017	3V1-02011-0	JUNTA CARBURADOR	GASKET CARBURETOR	GUARNIZIONE CARBURATORE	JOINT CARBURATEUR
49	PAF15-07000018	3V1-03952-0	SEPARADOR, CARBURADOR	INSULATOR, CARBURETOR	ISOLANTE, CARBURATORE	ISOLANT CARBURATEUR

4T MFS8 • MFS9.9  
STROKES

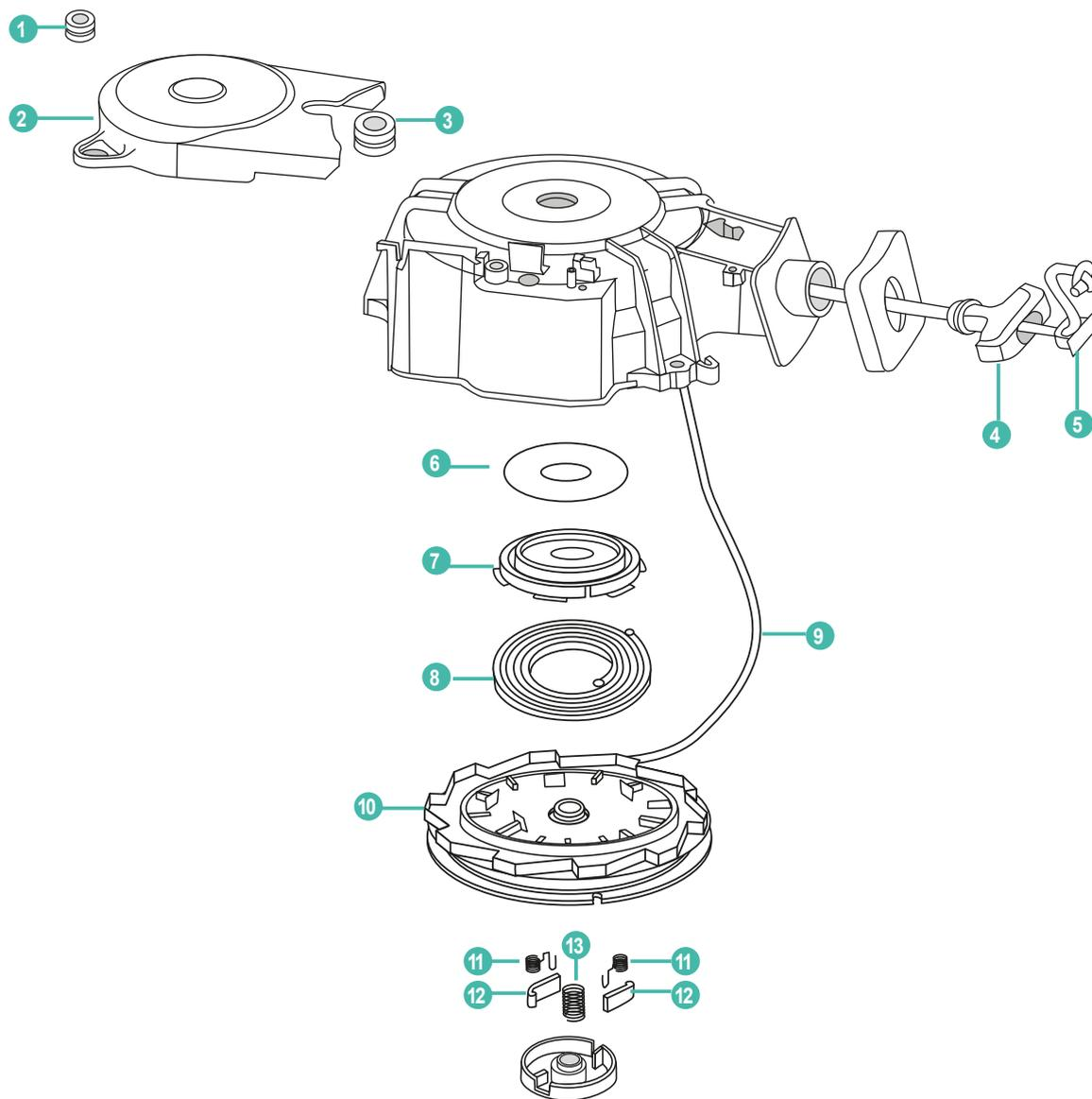

	REF	OEM				
1	PAF8-05000003	172-36008-0	RETÉN	RUBBER GROMMET A	TENUTA	JOINT
2	PAF8-05000012	3V1-06308-0	TAPA	COVER, STRAP	COPERCHIO	COUVERCLE
3	PAF8-05000013	3V1-06302-0	RETÉN	RUBBER GROMMET B	TENUTA	JOINT
4	PAF4-04130101	3AA-05019-0	TIRADOR	HANDLE, STARTER	MANIGLIA AVVIAMENTO	POIGNEE DE LANCEUR
5	PAF4-04130102	3R1-05131-0	TAPA	COVER, HANDLE	COPERCHIO	COUVERCLE
6	PAF8-05050002	3V1-05259-0	ARANDELA	WASHER, THRUST	RONDELLA	RONDELLE
7	PAF8-05050003	3R1-05125-0	MUELLE	SPRING CASE	MOLLA	RESSORT
8	PAF8-05050004	3AA-05004-0	MUELLE	VOLUTE SPRING	MOLLA	RESSORT
9	PAF8-05050018	3AA-05013-0	CUERDA	START LINE	CORDA DI AVVIAMENTO	CORDE DE LANCEUR
10	PAF8-05050005	3V1-05104-1	VOLANTE	WHELL, START-UP	VOLANTE	VOLANT
11	PAF8-05050007	3R1-05012-0	MUELLE	SPRING, TENSIÓN	MOLLA	RESSORT
12	PAF8-05050006	3R1-05003-1	UÑA PLÁSTICA	PAWL, DRIVE	NOTTOLINO	CLIQUET
13	PAF8-05050009	3R1-05007-0	MUELLE	SPRING PLATE	MOLLA	RESSORT

**JUNTAS DE MOTOR  
4 TIEMPOS**

**ENGINE GASKET  
4 STROKES**

**GUARNIZIONI  
MOTORE 4 TEMPI**

**JOINTS DE MOTEUR  
4 TEMPS**

**JUNTAS DE CULATA**

**CYLINDER HEAD GASKET**

**GUARNIZIONE DE TESTATA**

**JOINT DE CULASSE**

REF	OEM
REC309-01005-2	309-01005-2

 M2.5  
 M2.5A  
 M2.5A2  
 M3.5A  
 M3.5A2



REF	OEM
REC346-01005-0	346-01005-0

 M25C3  
 M30A4



REF	OEM
REC3B2-01005-0	3B2-01005-0

 M6B  
 M8B  
 M9.8B



REF	OEM
REC3C8-01005-4	3C8-01005-4

 M40D2  
 M50D2



REF	OEM
REC351-01005-0	351-01005-0

 M9.9D  
 M15D  
 M9.9D2  
 M15D2



REF	OEM
REC3F3-01005-0	3F3-01005-0

 M60C  
 M70C



REF	OEM
REC350-01005-0	350-01005-0

 M18E2



REF	OEM
REC3T9-01005-0	3T9-01005-0

 MD70  
 MD90



**KITS  
JUNTAS DE CULATA**

**CYLINDER HEAD GASKET  
KIT**

**KIT  
GUARNIZIONE TESTATA**

**KITS  
JOINTS MOTEUR**

REF	OEM
REC3T5-87121-6	3T5-87121-6

 MD40B2  
 MD50B2

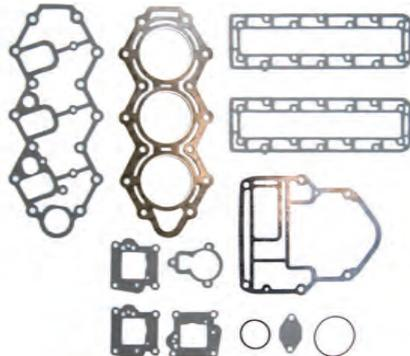

REF	OEM
REC3B7-87121-1	3B7-87121-7

 M80A  
 M90A

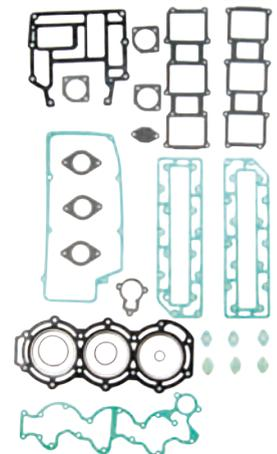

**JUNTAS DE CULATÍN**

**GASKET, HEAD COVER**

**GUARNIZIONE COPERCHIO  
TESTA**

**JOINTS DE COUVRE  
CULASSE**

REF	OEM
REC3C8-01024-0	3C8-01024-0

 M40D2  
 M50D2



REF	OEM
REC3F3-01024-0	3F3-01024-0

 M60C  
 M70C



**JUNTAS BASE DE MOTOR**

**CYLINDER GASKET**

**GUARNIZIONE  
BASE MOTORE**

**JOINTS DE TÊTE MOTRICE**

REF	OEM
REC350-01303-0	350-01303-0

-  M9.9D2
- M15D2
- M18E2

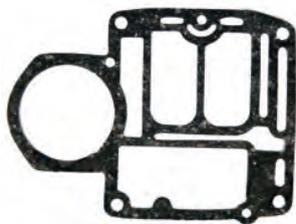

REF	OEM
REC3C8-01303-4	3C8-01303-4

-  MD40B
- MD50B

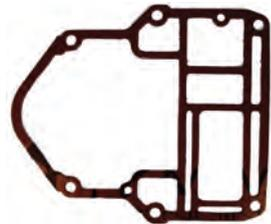

REF	OEM
REC350-61012-1	350-61012-1

-  M9.9D2
- M15D2
- M18E2



REF	OEM
REC3F3-01303-1	3F3-01303-1

-  M60C
- M70C



REF	OEM
REC346-01303-0	350-01303-0

-  M25C3
- M30A4

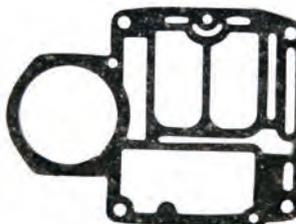

REF	OEM
REC3B2-01303-0	3B2-01303-0

-  M6B
- M8B
- M9.8B

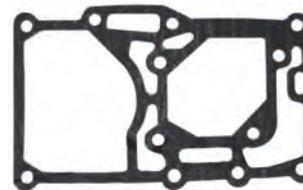

**RETENES DE ACEITE OIL SEALS**

**PARAOLIO**

**JOINT SPI**

**RETÉN DE ACEITE**

**OIL SEAL**

**PARAOLIO**

**JOINT SPI**

REF	OEM	
REC26-8537072	346-01215-0	18 x 28 x 6 mm

-  M25C3
- M30A4
- MFS25A-B
- MFS30A-B
- MFS40A
- MFS50A



REF	OEM	
REC26-161301	346-60111-0	18 x 28 x 8 mm

-  M25C3
- M30A4
- MFS30A - B
- MFS25A - B



REF	OEM	
REC26-161622	346-65013-0	17 x 30 x 9 mm

-  M15D2
- M18E2
- M25C3
- M30A4
- M9.9D2
- MFS20C
- MFS18B2
- MFS15C-B2
- MFS30B-A
- MFS25A-B
- MFS20C
- MFS9.9B2-C



REF	OEM	
REC26-803667	350-00121-0	25 x 45 x 8 mm

-  M9.9D2
- M15D2
- M18E2



REF	OEM	
REC8M0065585	350-01215-5	25 x 69 x 9,5 mm

-  M9.9D2
- M15D2
- M18E2



REF	OEM	
REC26-16703	369-01215-0	10 x 62 x 7 mm

-  M4C
- M5B
- M5BS
- MFS4A-B / 5A-B-C / 6A-B-C



REF	OEM	
REC26-16162	369-60223-0	10 x 24 x 8 mm

-  M4C
- M5B
- M5BS
- MFS4A-B / 5A-B-C / 6A-B-C



# CIGÜEÑAL

# CRANKSHAFT

# ALBERO MOTORE

# VILEBREQUIN

## RODAMIENTOS DE CIGÜEÑAL

## CRANKSHAFT BEARINGS

## CUSCINETTI ALBERO MOTORE ROULEMENTS VILEBREQUIN

SUPERIOR | UPPER | SUPERIORE | SUPERIEUR

REF	OEM
REC30-898101936	9643-3-6004

M2.5A  
M3.5A-B



INFERIOR | UNDER | INFERIORE | INFERIEUR

REF	OEM
REC30-95307	9643-3-6202

M2.5A  
M3.5A-B



# PISTONES

# PISTONS

# PISTONI

# PISTONS

## KITS DE PISTONES

## PISTON KITS

## KIT PISTONE

## KIT PISTON

	REF	STD	OEM
	REC779-803677		350-00001-0
	REC8M0080357		351-00011-0
	REC629-803674		350-00040-0
	REC41-825713002		332-00021-0
	REC53-16057		350-00024-1
	REC31-16052		350-00042-0

M9.9D2  
M15D2 (2 Cyl)



	REF	STD	OEM
	REC779-9615T		369-00001-0
	REC8M0080357		351-00011-0
	REC41-16056		369-00021-0
	REC53-16057		350-00024-1
	REC31-16052		350-00042-0

M4C  
M5B  
M5BS (1 Cyl)



	REF	STD	OEM
	REC779-803677T02		351-00001-1
	REC629-803674		350-00040-0
	REC41-803680002		350-00021-0
	REC53-16057		350-00024-1
	REC31-16052		350-00042-0

M18E2 (2 Cyl)



	REF	STD	OEM
	REC779-804886		3B2-00001-0
	REC39-803678A3		3B2-00011-0
	REC629-8036741		3B2-00040-0
	REC41-8036801		3B2-00021-0
	REC53-16057		350-00024-1
	REC31-8036752		338-00042-0

M6B  
M8B  
M9.8B (2 Cyl)



	STD	
	REF	OEM
	REC779-879194T01	346-00001-1
	REC39-16054A5	346-00011-0
	REC629-813047T01	336-00040-1
	REC41-803680003	3C8-00021-0
	REC53-16057	350-00024-1
	REC345-00042-0	345-00042-0

 M25C3  
M30A4 (2 Cyl)



	STD	
	REF	OEM
	REC779-96152	3C8-00001-3
	REC8M0080349	356-00011-0 346-00011-0
	REC629-8036741	3B2-00040-0
	REC41-803680003	3C8-00021-0
	REC53-16057	334-00024-1
	REC345-00042-0	345-00042-0

 M40D2  
M50D2 (3 Cyl)



	STD	
	REF	OEM
	PAF8-05020101	3V1-00001-0
	PAF8-05020200	3V1-00040-0
	PAF8-05020105	332-00024-0
	PAF15-07020005	350-00024-1

 MFS8  
MFS9.8A-A2-A3 (2 Cyl)





**P 51**

REF  
CRA904633  
CRA946331



REF  
SSP4213

**P 51**

# SISTEMA DE ESCAPE Y ADMISIÓN EXHAUST & INTAKE SYSTEM

# SISTEMA DI SCARICO E ASPIRAZIONE SYSTÈME D'ÉCHAPPEMENT ET D'ADMISSION

SISTEMA DE ESCAPE	EXHAUST SYSTEM	SISTEMA SCARICO	SYSTÈME D'ÉCHAPPEMENT
-------------------	----------------	-----------------	-----------------------

JUNTAS DE ESCAPE	GASKET, EXHAUST	GUARNIZIONE SCARICO	JOINTS D'ÉCHAPPEMENT
------------------	-----------------	---------------------	----------------------

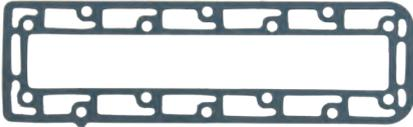
<table border="1"> <tr> <th>REF</th> <th>OEM</th> </tr> <tr> <td>REC3C8-02305-0</td> <td>3C8-02305-0</td> </tr> </table> <p>M40D2 / B M50D2 / B</p>	REF	OEM	REC3C8-02305-0	3C8-02305-0	
REF	OEM				
REC3C8-02305-0	3C8-02305-0				

SISTEMA DE ADMISIÓN	INTAKE SYSTEM	SISTEMA ASPIRAZIONE	SYSTÈME D'ADMISSION
---------------------	---------------	---------------------	---------------------

JUNTAS DE ADMISIÓN	GASKET, INTAKE	GUARNIZIONE ASPIRAZIONE	JOINTS D'ADMISSION
--------------------	----------------	-------------------------	--------------------

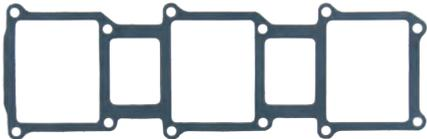
<table border="1"> <tr> <th>REF</th> <th>OEM</th> </tr> <tr> <td>REC17109-ZY6-000</td> <td>HZY6-17109-000</td> </tr> </table> <p>BFT90AK1 BFT75AK1 BFT115A BFT150A</p>	REF	OEM	REC17109-ZY6-000	HZY6-17109-000		<table border="1"> <tr> <th>REF</th> <th>OEM</th> </tr> <tr> <td>REC3T9-02104-0</td> <td>3T9-02104-0</td> </tr> </table> <p>MD70B MD90B</p>	REF	OEM	REC3T9-02104-0	3T9-02104-0	
REF	OEM										
REC17109-ZY6-000	HZY6-17109-000										
REF	OEM										
REC3T9-02104-0	3T9-02104-0										

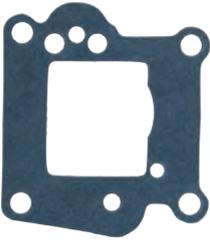
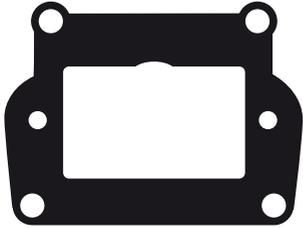
<table border="1"> <tr> <th>REF</th> <th>OEM</th> </tr> <tr> <td>REC3C8-02104-0</td> <td>3C8-02104-0</td> </tr> </table> <p>M40D2 M50D2</p>	REF	OEM	REC3C8-02104-0	3C8-02104-0		<table border="1"> <tr> <th>REF</th> <th>OEM</th> </tr> <tr> <td>REC3F3-02104-0</td> <td>3F3-02104-0</td> </tr> </table> <p>M60C M70C</p>	REF	OEM	REC3F3-02104-0	3F3-02104-0	
REF	OEM										
REC3C8-02104-0	3C8-02104-0										
REF	OEM										
REC3F3-02104-0	3F3-02104-0										

# UNIDADES DE TRANSMISIÓN UNIT DRIVES & COMPONENTS

# UNITÀ DI TRASMISSIONE EMBASES ET PIÈCES

DESPIECE COLAS

GEAR CASE PARTS

PARTI PIEDI

PIÈCES D'EMBASES

4T MFS8 • MFS9.8  
STROKES

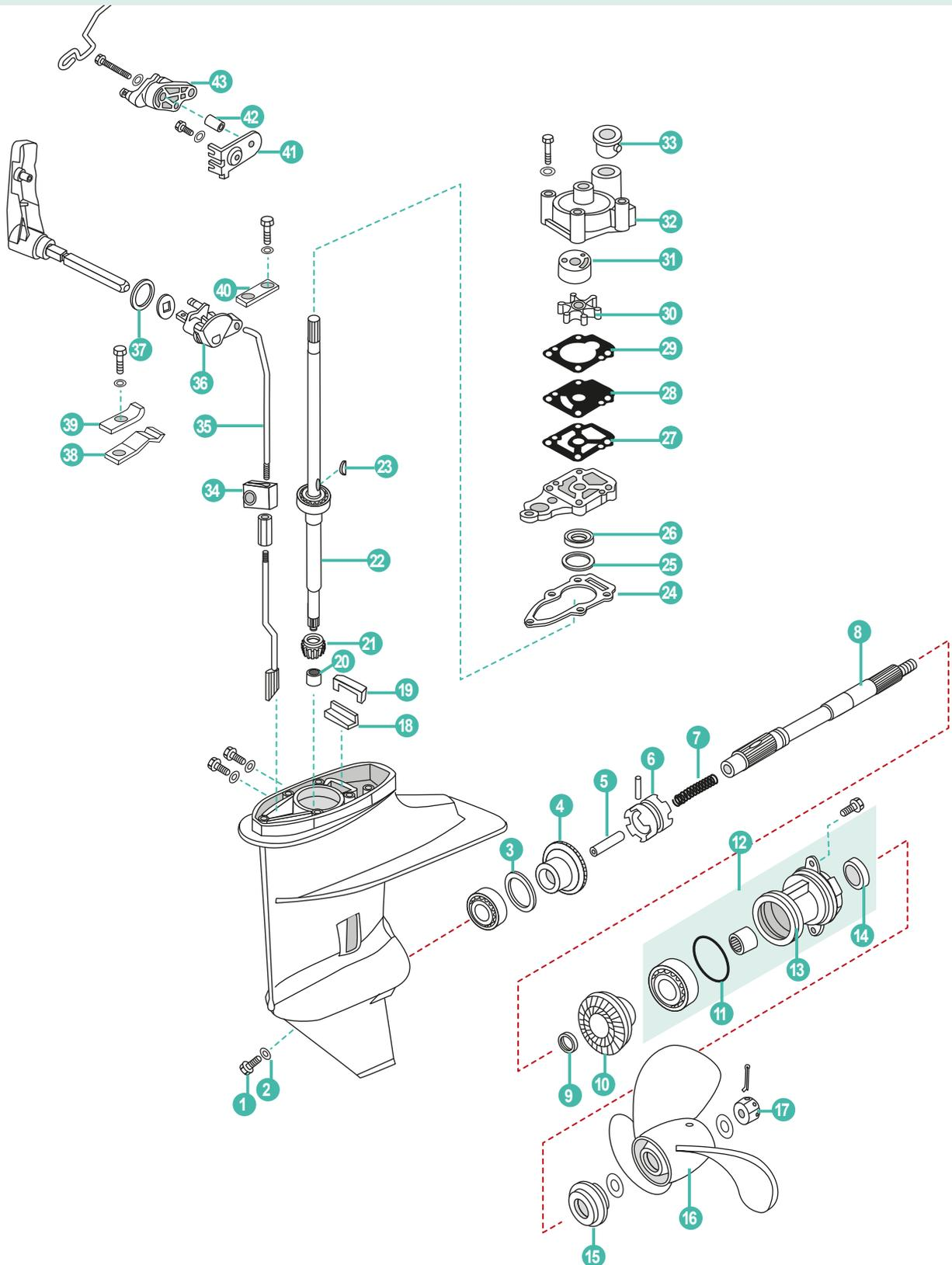

TOHATSU

RECAMBIOS  
MARINOS



	REF	OEM				
1	REC90340-08002	332-60005-2	TAPÓN DRENAJE	PLUG, OIL HOSE	CONNETTORE	BOUCHON DE VIDANGE
2	REC90430-08020	332-60006-0	JUNTA	GASKET	GUARNIZIONE	JOINT
3	PAF8-04000012-1	369-64014-0	GRUESO 0.10mm	SHIM 0.10mm	SPESSORE 0.10mm	CALE 0.10 mm
	PAF8-04000012-2	369-64015-0	GRUESO 0.15mm	SHIM 0.15mm	SPESSORE 0.15mm	CALE 0.15mm
4	PAF8-04010000	3B2-64010-0	PIÑÓN ADELANTE	GEARM FORWARD	PIGNONE AVANTI	PIGNON DE MARCHE AVANT
5	PAF8-04000305	369-64223-0	PIN	PIN CLUTCH	SPINOTTO	PIN
6	PAF8-04000303	3B2-64215-0	SELECTOR	CLUTCH, DOG	SELETTORE	CRABOT
7	PAF8-04000302	3V1-64221-0	MUELLE	SPRING, CLUTCH	MOLLA	RESSORT
8	PAF8-04000301	3V1-64211-0	EJE HÉLICE	SHAFT, PROPELLER	ASSE ELICHE	ARBRE D'HELICE
9	PAF8-04000012	369-64032-0	ARANDELA	WASHER	RONDELLA	RONDELLE
10	PAF8-04000014	3B2-64030-0	PIÑÓN ATRÁS	GEAR REVERSE	PIGNONE MARCIA INDIETRO	PIGNON DE MARCHE ARRIÈRE
11	PAF8-04040002	345-65015-0	TÓRICA	O-RING	ANELLO	JOINT TORIQUE
12	PAF8-04040000	3B2S60100-0	DIÁBOLO	COVER ASSY	DIABOLO	DIABOLO COMPLET
13	PAF8-04040001	3B2S60101-0	DIÁBOLO	COVER, LOWE CASING	DIABOLO	DIABOLO
14	PAF8-04040004	369-60111-0	RETÉN	OIL SEAL	PARAOLIO	JOINT SPI
15	PAF8-04000019	3B2-64230-1	GRUESO	CUSHION, PROPELLER	SPESSORE	CALE
16	PAF8-04050000	3B2W64517-0	HÉLICE	PROPELLER ASSY	ELICHE	HELICE
17	PAF15-06000016	369-64121-0	TUERCA	NUT, HEXAGON	DADO	ÉCROU
18	PAF8-04000015	3V1-60042-0	GUÍA SELLO DE GOMA	GUIDE RUBBER SEAL	GUIDA PARAOLIO	GUIDE EN CAOUTCHOUC
19	PAF8-04000016	3V1-60041-0	SELLO DE GOMA	WATER ENVELOP	PARAOLIO	SUPPORT EN CAOUTCHOUC
20	PANSKFJ-1516	3V1-60211-0	RODAMIENTO	BEARING	CUSCINETTO	ROULEMENT
21	PAF8-04000003	3B2-64020-0	PIÑÓN DE ATAQUE	INITIATIVE GEAR	PIGNONE ATTACCO	PIGNON D'ATAQUE
22	PAF8-04020001L	3V1-64307-1	EJE VERTICAL L	DRIVE SHAFT L	ASSE VERTICALE L	ARBRE DE COMMANDE L
	PAF8-04020001S	3V1-64306-1	EJE VERTICAL S	DRIVE SHAFT S	ASSE VERTICALE S	ARBRE DE COMMANDE S
23	PAF8-04000021	3B2-65022-0	PIN	PIN, DOWER	SPINOTTO	PIN
24	PAF8-04000005	3B2-65020-0	JUNTA	GASKET, WATER PUMP SEAT	GUARNIZIONE	JOINT
25	PAF8-04000004-1	3B2-64023-0	GRUESO 0.10 mm	SHIM 0.10mm	SPESSORE 0.10 mm	CALE 0.10 mm
26	PAF8-04000101	309-60111-0	RETÉN	OIL SEAL	PARAOLIO	JOINT SPI
27	PAF8-04000006	3B2-65029-0	JUNTA	GASKET, OUTER PLATE	GUARNIZIONE	JOINT
28	PAF8-04000007	3B2-65025-0	PLACA	OUTER PLATE	PIASTRA	PLAQUE
29	PAF8-04000008	3B2-65018-0	JUNTA	GASKET, OUTER PLATE	GUARNIZIONE	JOINT
30	PAF8-04000200	3B2-65021-1	IMPULSOR	IMPELLER	GIRANTE	TURBINE
31	PAF8-04000010	3B2-65011-0	CASQUILLO	INNER SHELL, WATER PUMP	BOCCOLA	COUVERCLE, POMPA À EAU
32	PAF8-04000009	3B2-65016-0	BOMBA DE AGUA	WATER PUMP	POMPA D'ACQUA	POMPA À EAU
33	PAF8-04000013	3B2-65016-0	RETÉN	SEAL	TENUTA	JOINT DE TUBE D'EAU
34	PAF8-03000011	3V1-66302-0	SEGURO	LOCK BLOCK	BLOCCAGGIO	SUPPORT TIGE DE CHANGEMENT DE VITESSE
35	PAF8-03000010	3V1-66211-0	EJE DEL CAMBIO	SHIFT ROD	ASSE CAMBIO	TIGE CHANGEMENT DE VITESSE
36	PAF8-03010003	3V1-66225-0	SEGURO DEL EJE	BLOCK SHIFT ROD	BLOCCAGGIO ASSE	TIGE DE BLOCAGE
37	PAF8-03010001	3V1-66187-0	ARANDELA	WASHER, HANDLE	RONDELLA	RONDELLE
38	PAF8-03010005	3B2-66113-0	TOPE	STOPPER, SHIFT LEVER	TAPPO	LEVIER
39	PAF8-03010006	3C8-66116-0	PLACA	PLATE, SHIFTLIVER STOPPER	PIASTRA	CONTRE PLAQUE LEVIER CAHNGEMENT VITESSE
40	PAF8-03010007	3B1-66145-0	PLACA	PLATE	PIASTRA	PLAQUE
41	PAF8-05000020	3V1-63508-0	PLACA	PALTE	PIASTRA	PLAQUE
42	PAF8-05000018	346-67114-0	CASQUILLO	PLATE ACCELEROGRAPH ENFOPCE	BOCCOLA	PLAQUE SUPPORT LEVIER PRINCIPAL
43	PAF8-05000019	3V1-63622-0	POLEA	MAIN PULLEY	PULEGGIA	POULIE

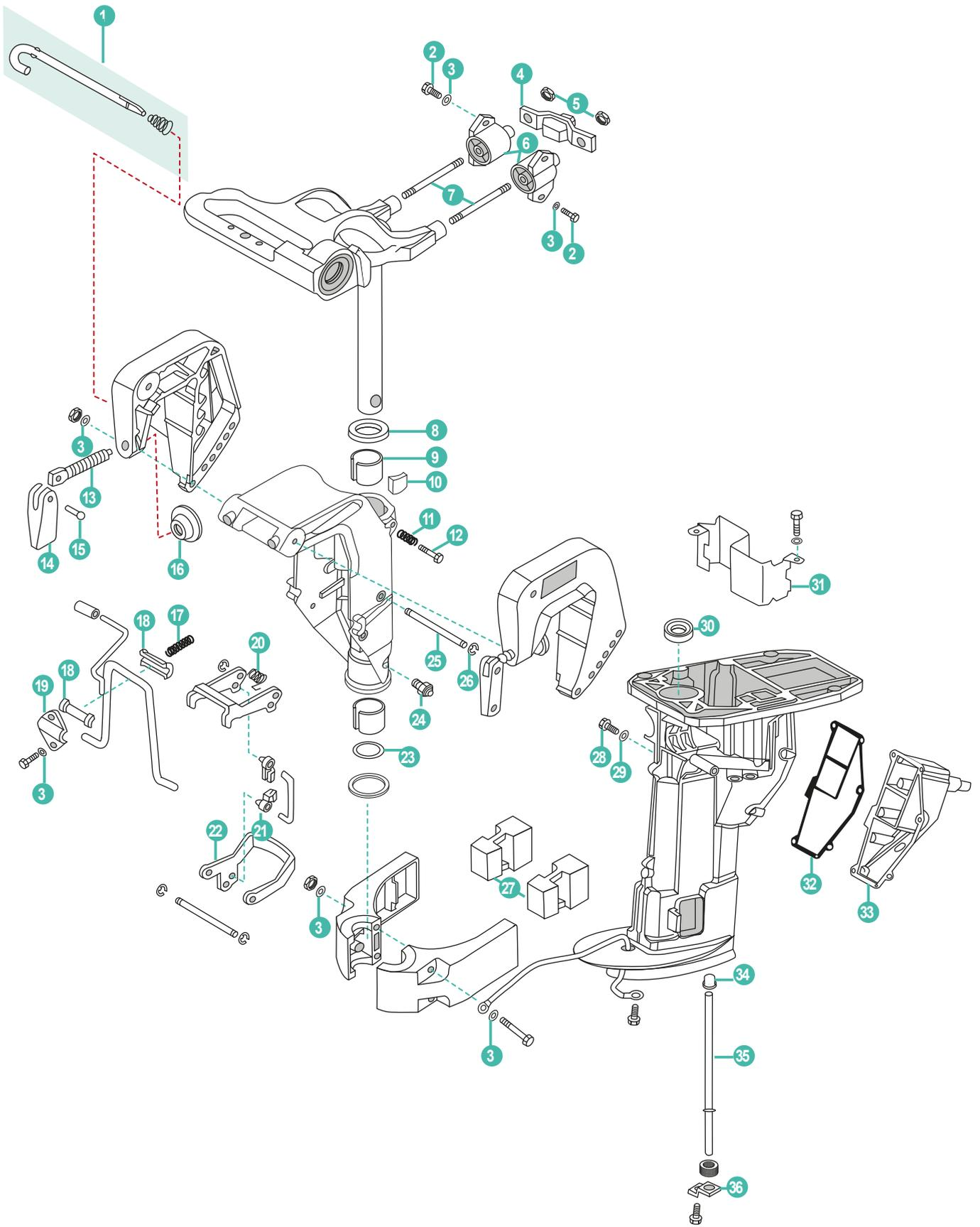

	REF	OEM				
1	PAF8-01010200	350-62121-1 369-62122-2	GANCHO DE CIERRE	THRUST ROD ASSY	ASSE DE CHIUSSURA	CROCHET DE FERMETURE
2	PAGB/T5783-M6X20	910184-5620	TORNILLO	BOLT M6x20	VITE	VIS
3	PAGB/T97.1-6	910184-5620	ARANDELA	WASHER	RONDELLA	RANDELLE
4	PAF8-00000100	3V1-61333-1	SILENBLOCK	ABSORBER (FRONT)	SILENBLOCK	SILENBLOCK
5	PAGB/T889.1-M8	3V1-61324-0	TUERCA M8	NUT M8	DADO M8	ÉCROU M8
6	PAF8-02000100	3V1-61301-1 940113-0800	SILENBLOCK	ABSORBER ASSY	SILENBLOCK	SILENBLOCK
7	PAF8-01000003	3V1-61313-0	TORNILLO M8x65	DICEPHALOUS BOLT M8x65	VITE M8x65	VIS M8x65
8	PAF8-01000001	350-62423-0	ARANDELA	WASHER, ROTARY BRACKET	RONDELLA	RONDELLE
9	PAF8-01000002	350-62417-0	CASQUILLO	BUSHING	BOCCOLA	ENTRETOISE
10	PAF8-01000100	345-62441-0	SEGURO DE CIERRE	LOCKING BLOCK ASSY	CHIUSURA SICUREZA	BLOC DE VERROUILLAGE
11	PAF8-01010102	346-62421-1	MUELLE	SPRING, LOCKING	MOLLA	RESSORT
12	PAGB/T5783-M8X30	910113-0830	TORNILLO M8X30	BOLT M8x30	VITE M8X30	VIS M8X30
13	PAF4-01010002	398-62103-0	TORNILLO	CLAMP SCREW	VITE	VIS
14	REC6L8-G3118-01	332S62102-1	MANETA	CLAMP HANDLE, STERN	MANIGLIA	POIGNEE DE BLOCAGE
15	PAF4-01010005	3C8-62104-1	RIBETE	RIVET, CLAMP HANDLE	RIVETTO	RIVET
16	PAF4-01010003	332-62101-0	ARANDELA	CLAMP PAD	RONDELLA	RONDELLE
17	PAF8-01010104	369-66112-1	MUELLE	SPRING, SUPPORT	MOLLA	RESSORT
18	PAF8-01010103	393-62437-0	PASADOR	PIN	PIN	PIN
19	PAF8-01010105	369-62439-1	PLACA	PRESS PLATE	PIASTRA	PLAQUE
20	PAF8-01010109	3B2-66315-0	MUELLE	SPRING, WREST	MOLLA	RESSORT
21	PAF8-01010112	3K9-05223-0	ADAPTADOR	TIE-IN, CONNECTING ROD	ADATTATORE	EMBOUT DE CABLE
22	PAF8-01010106	3V1-66313-0	UÑA	OUTER FRAME, ROTARY BRACKET	CORNICE ESTERNA	CADRE EXTERIEUR POUR SUPPORT ROTATIF
23	PAJASOF40435-022	350-62415-0	RETÉN	O-RING Ø22.4xØ3.5	TENUTA ANELLO	JOINT
24	PAGB/T7940.1-M6	344-67177-0	ENGRASADOR M6	OILER M6	INGRASSATORE M6	GRAISSEUR M6
25	PAF8-01010108	3B2-66321-1	EJE	SHAFT, ROTARY BRACKET	ASSE	AXE
26	PAGB/T896-5	945303-0500	CLIP	CIRCLIP	CLIP	CLIP
27	PAF8-00000002	3V1-61302-0	AMORTIGUADOR	ABSORBER	AMMORTIZZATORE	SILENT BLOC
28	PAF15-04000002	3R3-07405-1	TAPÓN	BOLT, OIL DRAIN	TAPPO	BOUCHON
29	PAF15-04000003	3R3-07406-0	JUNTA	GASKET	GUARNIZIONE	JOINT
30	PAF8-02000002	3B2-01215-0	RETÉN	OIL SEAL	PARAOILIO	JOINT SPI
31	PAF8-02000003	3V1-07440-0	SEPARADOR CARTER	CLAPBOARD, OIL SUMP	ASSICELLA, COPPA OLIO	PLAQUE GUIDE
32	PAF8-02000004	3V1-61220-0	JUNTA TAPA DE ESCAPE	GASKET, EXHAUST OUTER COVER	GUARNIZIONE COPERCHIO SCARICO	JOINT DE COUVERCLE EXT ECHAPPEMENT
33	PAF8-02000005	3V1-61208-0	TAPA ESCAPE	EXHAUST OUTER COVER	COPERCHIO SCARICO	COUVERCLE EXT ECHAPPEMENT
34	PAF8-02000007	3V1-65206-0	RETÉN TUBO DE AGUA	UPPER SEAL, WATER PIPE	TENUTA, TUBO ACQUA	JOINT SUPERIEUR TUBE D'EAU
35	PAF8-02000006(L)	3V1-65110-0	TUBO L	WATER PIPE L	TUBO L	TUYAU D'EAU L
	PAF8-02000006(S)	3V1-65100-0	TUBO S	WATER PIPE S	TUBO S	TUYAU D'EAU S
36	PAF8-02000009	3V1-65203-0	PLACA TUBO DE AGUA	PLATE, WATER PIPE	PIASTRA, TUBO ACQUA	PLAQUE PIPE D'EAU

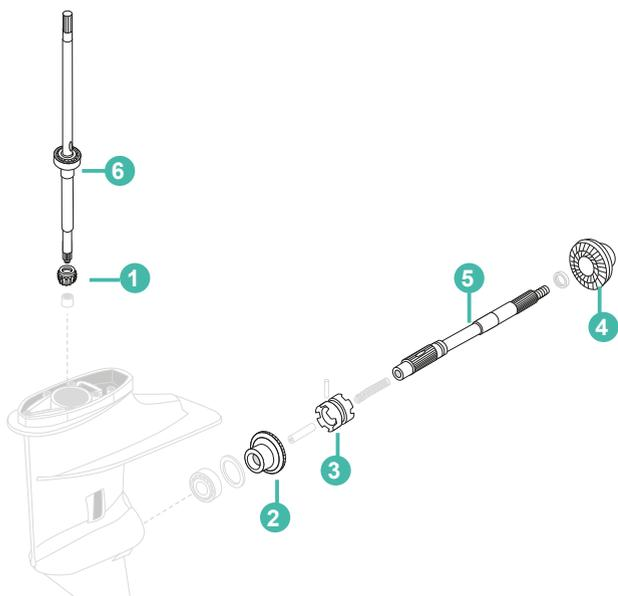

GUÍA PIEZAS COLA

STERN DRIVE  
COMPONENTS GUIDE

GUIDA RICAMBI  
PIEDI

GUIDE PIECES  
D'EMBASE

	1	2	3	4	5	6 S	6 L
M2.5A, B, A2	REC43-16138	REC43-812944					
M3.5A, B, A2, B2	REC43-16138	REC43-812944					
M4C M5B, BS	REC43-16138	REC43-812944		REC43-8129451	REC44-195133	REC45-161351	REC8M0076368
MFS4, 5, 6A2, B, C	REC43-16138	REC43-812944		REC43-8129451	REC44-195133	REC45-161351	REC8M0076368
MFS8, 9.8B	PAF8-04000003	PAF8-04010000		PAF8-04000014	PAF8-04000301		
MFS8A2-3 MFS9.8A2-3 M9.9	PAF8-04000003	PAF8-04010000	PAF8-04000303	PAF8-04000014	PAF8-04000301	PAF8-04020001S	PAF8-04020001L
M15D2 M18E2 MFS9.9B2	REC43-803740	REC43-803739		REC43-803741	REC879147T96	REC45-803738	REC45-8037381
MFS15B2 MFS18B2	REC43-803740T02	REC43-803739T03		REC43-803741T03	REC879147T96		

# SISTEMA DE PROPULSIÓN PROPULSION SYSTEM

# SISTEMA DI PROPULSIONE SYSTEME DE PROPULSION

HÉLICES ALUMINIO E INOXIDABLE DE 3 Y 4 PALAS	3 & 4 BLADE ALUMINIUM & SS PROPELLERS	ELICHE ALLUMINIO E INOX DA 3 E 4 PALE	HELICE ALUMINIUM ET INOX 3 ET 4 PALES
CÓDIGO DE REFERENCIAS	PART NO. CODING SYSTEM	SISTEMA DI CODICE	CODAGE DES REFERENCES
<p>1. Mercury, Mariner 2. Johnson, Evinrude 3. Yamaha 4. Suzuki 5. Tohatsu 6. 7. 8. Volvo Penta 9. Rubex System</p>	<p>0.5, 6, 8 and 9.8 HP Group 1. A Group 2. B Group 3. C Group 4. D Group 5. E Group 6. F Group 7. VP (Std. Hub) 8. VP (Long Hub)</p>	<p>1. AL 2. Saturn (INOX   Stainless Steel) 3. New Saturn (INOX   Stainless Steel) 4. Titan (INOX   Stainless Steel) 5. HR Titan (INOX   Stainless Steel) 6. Scorpion (INOX   Stainless Steel) 7. Lector (INOX   Stainless Steel)</p>	<p>1. 3R Rubber Hub 2. 3L Rubber Hub 3. 4R Rubber Hub 4. 4L Rubber Hub</p>

SOLAS

## AMITA 3

SOLAS

Hélice de aluminio con núcleo de goma de gran resistencia.

Aluminum propeller with heavy duty rubber hub.

Eliche di alluminio con mozzi in gomma ad alta resistenza.

Hélice en aluminium avec moyeu en caoutchouc



## AMITA 4

SOLAS

Hélices de aluminio con núcleo de goma de gran resistencia. Van muy suaves a poca velocidad y hace el barco muy manejable con la mar picada.

Aluminum propeller with heavy duty rubber hub. Smoother low speed makes the offshore boating activity much easier.

Eliche di alluminio con mozzo in gomma ad alta resistenza. Molto morbido a bassa velocità e rende la barca molto maneggevole con mare cattivo.

Hélice en aluminium avec moyeu en caoutchouc. Permet d'aller doucement à basse vitesse et rende le bateau très maniable lorsque la mer est agitée



## NEW SATURN

SOLAS

Hélices de acero inoxidable. Ofrece buena aceleración y rendimiento. Tamaño más pequeño que ofrece un diámetro extragrande.

Stainless steel propeller. Offers good acceleration & all-round performance. Smaller pitch sizes offered in extra large diameter with increased blade area.

Eliche di acciaio inox. Buona accelerazione. Piccole dimensioni che offre un più grande diametro.

Hélice inox, offrant de bonnes accélérations et performances. Taille de pas réduite pour les modèles de grands diamètres avec une surface de pale plus importante.

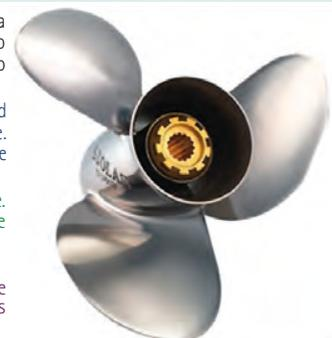

GUÍA DE HÉLICES  
CON NÚCLEO INTEGRADO

PROPELLERS APPLICATION  
WITH RUBBER HUB

GUIDA ELICHE  
CON MOZZO

GUIDE DES HELICES  
ET MOYEUX

Strokes	R.O. OEM	A B D P R					AL		INOX STAINLESS STEEL
		AMITA 3		AMITA 4		NEW SATURN			
5	✓				7				
4, 5, 6	✓		3	7,8	8	R	SOL5011-078-07 SOL5011-078-08		
		3B2-64513-0			6,5		SOL5011-085-07		
8, 9'8	✓	3B2-64515-0	12	3	8,5	7,5	R	SOL5011-085-08	
		3B2-64517-0			8,5		SOL5011-085-09		
		362-64105-0			6,9		SOL5111-093-07		
9'9, 12, 15, 18	✓	362-64103-0			7,8		SOL5111-093-08		
		362-64101-0			8,8		SOL5111-093-09		
			14	3	9,2	9,1	R	SOL5111-093-09	
9'9, 15, 18, 20	✓	362-64108-0			9,8		SOL5111-093-10		
					11		SOL5111-093-11		
		346-64101-5			9,8	9,3		SOL5211-099-09	
		346-64102-5			9,8	10,2		SOL5211-099-10	
25, 30	✓	346-64103-5			9,8	11,3	R	SOL5211-099-11	
					9,9	12		SOL5211-099-12	
		346-64104-5			9,8	13,1		SOL5211-099-13	
					12,2	7		SOL5311-122-07	
		361-64113-0			12,2	8		SOL5311-122-08	
		361-64114-0			12,1	9		SOL5311-121-09	SOL5313-118-09
		348-64102-0			11,6	11		SOL5311-116-11	SOL5313-111-11
35, 40, 50, 55	✓	348-64103-0			11,4	12		SOL5311-114-12	SOL5313-108-12
		3E3-64528-0	13	3	11,1	13	R	SOL5311-111-13	SOL5313-105-13
		3E3-64536-0			11,1	14		SOL5311-111-14	SOL5313-105-14
					11	15		SOL5311-110-15	
					11	16		SOL5311-110-16	
					11	17		SOL5311-110-17	
		3B7-64523-1			14	11		SOL3411-140-11	
		3B7-64527-1			13,75	13		SOL3411-138-13	SOL3413-133-13
60, 70, 90, 115, 120, 140	✓	3C7-64536-0			13,5	15		SOL3411-135-15	SOL3413-130-15
		3C7-64541-0	15	3	13,25	17	R	SOL3411-133-17	SOL3413-128-17
		3C7-64554-0			13	19		SOL3411-130-19	SOL3413-125-19
					13	21		SOL3411-130-21	SOL3413-125-21

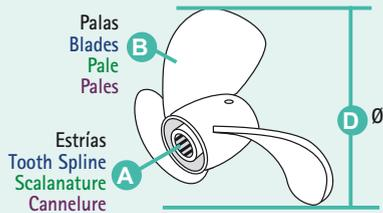

- P** Paso  
Pitch  
Passo  
Pas
- R** Rotación L (izquierda) R (derecha)  
Rotation L (left) R (Right)  
Rotazione L (SX) R (DX)  
Rotation L (gauche) R (droit)

**NÚCLEO INTERCAMBIABLE INTERCHANGEABLE HUB**

**MOZZO INTERCAMBIABILE MOYEU INTERCHANGEABLE**

	A	REF	
35HP (35B only) (1984+) 40HP (1984+), 50HP (All except 50C) (1992+) 50HP (50C only) (1987-91)	13	SOLRBX-116	C
55HP (1981-88) 60A (1986+) 70A/70B (1981+)	13	SOLRBX-112	C
90-140HP, (1987+)	13	SOLRBX-109	D



**RUBEX**

**HÉLICES PARA NÚCLEO INTERCAMBIABLE**

**PROPELLERS FOR INTERCHANGEABLE HUB**

**ELICHE PER MOZZO INTERCAMBIABILE**

**HELICES AVEC MOYEU INTERCHANGEABLE**

	B	D	P	R	AL
<b>C</b> 30-75 HP	3	11.4	12	R	SOL9311-114-12
		11.1	13	R	SOL9311-111-13
		14	9	R	SOL9411-140-09
		14	11	R	SOL9411-140-11
<b>D</b> 40-140 HP	3	13.75	13	R	SOL9411-138-13
		13.50	15	R	SOL9411-135-15
		13.25	17	R	SOL9411-133-17
		13.2	19	R	SOL9411-132-19
		13.2	21	R	SOL9411-132-21
		15.5	11	R	SOL9511-155-11
<b>E</b> 135-350 HP	3	15.3	13	R	SOL9511-153-13
		16	13	R	SOL9511-160-13
		15	15	R	SOL9511-150-15
		15	15	L	SOL9512-150-15
		14.8	17	R	SOL9511-148-17
		14.8	17	L	SOL9512-148-17
		14.5	19	R	SOL9511-145-19
		14.5	19	L	SOL9512-145-19
		14.3	21	R	SOL9511-143-21
		14.3	21	L	SOL9512-143-21

	B	D	P	R	INOX STAINLESS STEEL
<b>D</b> 40-140 HP	3	13 <sup>3/4</sup>	13	R	SOL9431-138-13
		13 <sup>3/4</sup>	13	L	SOL9432-138-13
		13 <sup>1/2</sup>	15	R	SOL9431-135-15
		13 <sup>1/2</sup>	15	L	SOL9432-135-15
		13 <sup>1/4</sup>	17	R	SOL9431-133-17
		13 <sup>1/4</sup>	17	L	SOL9432-133-17
		13	19	R	SOL9431-130-19
		13	19	L	SOL9432-130-19
		13	21	R	SOL9431-130-21
		<b>E</b> 90-140 HP	3	14 <sup>1/2</sup>	15
14 <sup>1/2</sup>	15			L	SOL9532-145-15
14 <sup>1/4</sup>	17			R	SOL9531-143-17
14 <sup>1/4</sup>	17			L	SOL9532-143-17
14	19			R	SOL9531-140-19
14	19			L	SOL9532-140-19
14	21			R	SOL9531-140-21
14	21			L	SOL9532-140-21
14	23			R	SOL9531-140-23
14	23			L	SOL9532-140-23
<b>E</b> 135-350 HP	3	15 <sup>3/4</sup>	15	R	SOL9571-158-15
		15 <sup>3/4</sup>	15	L	SOL9572-158-15
		15 <sup>1/2</sup>	17	R	SOL9571-155-17
		15 <sup>1/2</sup>	17	L	SOL9572-155-17
		15 <sup>1/4</sup>	19	R	SOL9571-153-19
		15 <sup>1/4</sup>	19	L	SOL9572-153-19
		15	21	R	SOL9571-150-21
		15	21	L	SOL9572-150-21
		14 <sup>3/4</sup>	23	R	SOL9571-148-23
		14 <sup>3/4</sup>	23	L	SOL9572-148-23

**RUBEX**



Núcleo intercambiable (no incluido).  
Interchangeable hub (not included).  
Mozzo intercambiabile (non incluso).  
Moyeu interchangeable (non inclus)

# REF--> RO / OEM

REF	R.O. / OEM	
<b>C</b>		
CEF500337	HZW1-19210-B04	604
CEF500338	HZV5-19210-003	604
CEF500344	3B2-65021-1	589-604
CEF500377	369-65021-1	589-604
CEF500379	345-65021-1	604
CEF500382	345-65021-0	589-604
CEF500383	334-65021-0	589-604
CEF500388	3B7-65021-2	604
CEF500388	3C7-65021-1	604
CEF500391	HZY3-19210-003	604
CEF500396	309-65021-1	604
CM33860-2181	338-60218-2	606
CM348-60217-0M	348-60217-0	606
CM3B7-602170	3B7-60217-0	606
CM3B7-60218-0	3B7-60218-1	606
CM3C760-2181	3C7760-2181	606
CM3C760-2181A	3C7760-2181	606
CM3C8-60217-0	3C8-60217-1	606
CM3H6-60218-000	3H6-60218-0	606
CM3H6-60218-000A	3H6-60218-0	606
CM3M2-60218-1	3M2-60218-0	606
CM3V1-60217-0	3V1602170	606
CM3V1-60217-0A	3V1602170	606
CM5338602182A0	5338602182A0	606
CM5338602182A0A	5338602182A0	606
CHAL78C		600
CHAL82C		600
CHAL82YC		600
CHAL86C		600
CHAL87YCC		600
CHARA8HC		600

REF	R.O. / OEM	
<b>G</b>		
GS30435		595
GS31001		594
GS31002		594
GS31015	394-702500M	592
GS31016	3B2-702801M	592
GS31017		592
GS31018	3B2-702601M	592
GS31019	99998-0MA2	591
GS31020		591
GS31064		592
GS31065		594
GS31066		594
GS31067		594
GS31068		591
GS31069		591
GS31073		591
GS31088		591
GS31090		590
GS31090		590
GS31095		590
GS31096		590
GS31097		590
GS31099		590
GS31155		594
GS31156		594
GS31157		594
GS31166		594
GS31183		590
GS31187	65770-95541	590
GS31189		590
GS35031		590
GS35032		590
GS31183		442
GS31187		442
GS31189		442
GS35031		442
GS35032		442

REF	R.O. / OEM	
<b>L</b>		
LENS3213		593
LENS3227	99105-20005	593

REF	R.O. / OEM	
<b>N</b>		
NGKB7HS-10	9701-1-1005	600
NGKB8HS-10	9701-1-1006	600
NGKBP7HS-10	9701-1-1010	600
NGKBP7HS-10	9701-1-1013	600
NGKBP7HS-10	9701-1-1014	600
NGKBR7HS-10	9701-1-1015	600
NGKBR8HS-10	9701-1-1110	600
NGKDCPR6E	9701-1-1103	589-600
NGKIKR6G8	9701-1-1121	600
NGKIZFR5J	9791-1-1109	600
NGKIZFR6	9701-1-1111	600
NGKLMAR6C-9	HZZ3-31909-003	600

REF	R.O. / OEM	
<b>P</b>		
PAF15-04000002	3R3-07405-1	625
PAF15-04000003	3R3-07406-0	625
PAF15-06000016	369-64121-0	623
PAF15-07000017	3V1-02011-0	615
PAF15-07000018	3V1-03952-0	615
PAF15-07000031	HZW9-19300-003	603
PAF15-07010100	3H6-07611-0	598-613
PAF15-07010101	3H6-07612-0	613
PAF15-07020005	350-00024-1	615-620
PAF15-07040303	3R0-07238-0	615
PAF15-07040304	3H8-07237-0	615
PAF15-07080000	3AC-02230-0	594
PAF15-07080000	3AD-02230-0	594
PAF15-07080000	3B7-02230-0	594
PAF4-01010002	398-62103-0	625
PAF4-01010003	332-62101-0	625
PAF4-01010005	3C8-62104-1	625
PAF4-04000019	3T5-10131-0	615
PAF4-04000030		591
PAF4-04130101	3AA-05019-0	616
PAF4-04130102	3R1-05131-0	616
PAF4-05000010		591
PAF4-05000300	369-02230-0	595
PAF4-05000300	396-02230-0	595
PAF4-05000300		589
PAF40-0701000E1		594
PAF8-00000002	3V1-61302-0	625
PAF8-00000003	3R3-61017-0	615
PAF8-00000004	3V1-01303-0	615
PAF8-00000100	3V1-61333-1	625
PAF8-00000200	3V1-07421-0	615
PAF8-005030010	3H8-07226-0	615
PAF8-01000001	350-62423-0	625
PAF8-01000002	350-62417-0	625
PAF8-01000003	3V1-61313-0	625
PAF8-01000100	345-62441-0	625
PAF8-01010102	346-62421-1	625
PAF8-01010103	393-62437-0	625
PAF8-01010104	369-66112-1	625
PAF8-01010105	369-62439-1	625
PAF8-01010106	3V1-66313-0	625
PAF8-01010108	3B2-66321-1	625
PAF8-01010109	3B2-66315-0	625
PAF8-01010112	3K9-05223-0	625
PAF8-01010200	350-62121-1	625
PAF8-01010200	369-62122-2	625
PAF8-02000002	3B2-01215-0	625
PAF8-02000003	3V1-07440-0	625
PAF8-02000004	3V1-61220-0	625
PAF8-02000005	3V1-61208-0	625
PAF8-02000006(L)	3V1-65110-0	625
PAF8-02000006(S)	3V1-65100-0	625
PAF8-02000007	3V1-65206-0	625
PAF8-02000009	3V1-65203-0	625
PAF8-02000100	3V1-61301-1	625
PAF8-02000100	940113-0800	625
PAF8-03000010	3V1-66211-0	623
PAF8-03000011	3V1-66302-0	623
PAF8-03010001	3V1-66187-0	623
PAF8-03010003	3V1-66225-0	623
PAF8-03010005	3B2-66113-0	623
PAF8-03010006	3C8-66116-0	623
PAF8-03010007	3B1-66145-0	623
PAF8-04000003	3B2-64020-0	623-626
PAF8-04000004-1	3B2-64023-0	623
PAF8-04000005	3B2-65020-0	623
PAF8-04000006	3B2-65029-0	623
PAF8-04000007	3B2-65025-0	605-623
PAF8-04000008	3B2-65018-0	623
PAF8-04000009	3B2-65016-0	623
PAF8-04000010	3B2-65011-0	605-623
PAF8-04000012	369-64032-0	623
PAF8-04000012-1	369-64014-0	623
PAF8-04000012-2	369-64015-0	623
PAF8-04000013	3B2-65016-0	623
PAF8-04000014	3B2-64030-0	623-626
PAF8-04000015	3V1-60042-0	623
PAF8-04000016	3V1-60041-0	623
PAF8-04000019	3B2-64230-1	623
PAF8-04000021	3B2-65022-0	623
PAF8-04000101	309-60111-0	623
PAF8-04000200	3B2-65021-1	623
PAF8-04000301	3V1-64211-0	623-626
PAF8-04000302	3V1-64221-0	623
PAF8-04000303	3B2-64215-0	623-626
PAF8-04000305	369-64223-0	623
PAF8-04010000	3B2-64010-0	623-626
PAF8-04020001L	3V1-64307-1	623-626
PAF8-04020001S	3V1-64306-1	623-626
PAF8-04040000	3B2S60100-0	623
PAF8-04040001	3B2S60101-0	623

REF	R.O. / OEM	
PAF8-04040002	345-65015-0	623
PAF8-04040004	369-60111-0	623
PAF8-04050000	3B2W64517-0	623
PAF8-05000002	3V1-01024-0	615
PAF8-05000003	172-36008-0	616
PAF8-05000004	3V1-10045-0	589-615
PAF8-05000006	3A0-76079-0	613
PAF8-05000007	3B7-06305-0	613
PAF8-05000008	3V1-02010-1	615
PAF8-05000009	3V1-02104-0	615
PAF8-05000011	3T5-06920-0	613
PAF8-05000012	3V1-06308-0	616
PAF8-05000013	3V1-06302-0	616
PAF8-05000017	98AH10-0120	615
PAF8-05000018	346-67114-0	623
PAF8-05000019	3V1-63622-0	623
PAF8-05000020	3V1-63508-0	623
PAF8-05000021	3R0-66308-0	613
PAF8-05000024	369-00132-0	613
PAF8-05000024	98AB-5-0330	615
PAF8-05000025	369-84398-0	615
PAF8-05000100	3V1-02305-0	615
PAF8-05000200	3V1-06071-0	599-613
PAF8-05000300	3AA-06021-0	598-613
PAF8-05000400	3AA-06060-0	613
PAF8-05000400	3AA-06060-00	601
PAF8-05000400	3AA060600M	601
PAF8-05000500	3V1-06040-0	599-613
PAF8-05000500	3V1060400	599
PAF8-05000500	3V1060400M	599
PAF8-05000600	3AA-06091-0	613
PAF8-05000800	3V1-07410-0	615
PAF8-05010000	3V1B01100-0	615
PAF8-05010002	3H8-02093-0	615
PAF8-05010004	3V1-02305-0	615
PAF8-05010005	346-01032-0	615
PAF8-05010009	3V1-07407-0	615
PAF8-05010012	3V1-00121-0	615
PAF8-05010014	3V1-10060-0	615
PAF8-05010015	3V1-10063-0	615
PAF8-05010016	3V1-10068-0	615
PAF8-05020001	3V1-00030-1	615
PAF8-05020101	3V1-00001-0	615-620
PAF8-05020105	332-00021-0	615
PAF8-05020105	332-00024-0	620
PAF8-05020200	3V1-00040-0	615-620
PAF8-05030001	3V1-07201-0	615
PAF8-05030002	3V1-07202-0	615
PAF8-05030004	3V1-07205-0	615
PAF8-05030005	3AA-07203-0	615
PAF8-05030006	3V1-07221-0	615
PAF8-05030007	3H6-07223-0	615
PAF8-05030008	3V1-07010-0	615
PAF8-05030009	3AA-07225-0	615
PAF8-05030011	3H8-07025-0	615
PAF8-05030012	3V1-07653-0	615
PAF8-05030015	3R3-07227-0	615
PAF8-05030100	3V1B01001-0	615
PAF8-05030200	3V1-07235-0	615
PAF8-05030300	3V1-07600-0	615
PAF8-05030400	3H8-10062-2	615
PAF8-05040000	3V2-03100-2	596
PAF8-05050002	3V1-05259-0	616
PAF8-05050003	3R1-05125-0	616
PAF8-05050004	3AA-05004-0	616
PAF8-05050005	3V1-05104-1	616
PAF8-05050006	3R1-05003-1	616
PAF8-05050007	3R1-05012-0	616
PAF8-05050009	3R1-05007-0	616
PAF8-05050018	3AA-05013-0	616
PAF8-05090000W	3V1-06023-0	599
PAGB/T5783-M6X20	910184-5620	625
PAGB/T5783-M8X30	910113-0830	625
PAGB/T940.1-M6	344-67177-0	625
PAGB/T889.1-M8	3V1-61324-0	625
PAGB/T896-5	945303-0500	625
PAGB/T97.1-6	910184-5620	625
PAJASOF40435-022	350-62415-0	625
PANSKFJ-1516	3V1-60211-0	623
PAT15-04000011	940121-1200	613
PAT3.6-04000006	309-00131-0	615
PH130-0006	3C8-76010-1	600
PH130-0006	3C8760101	600
PH130-0006	3C8760101M	600
PH130-0048	353-76010-4	600
PH130-0061	350-76010-0	600
PH130-0061	3AA760100	600
PH130-0070	HZY3-31200-003	601
PH130-0080	346-76010-0M	600
PH200-T024		602
PH200-WH01		602

TOHATSU

RECAMBIOS MARINOS



REF	R.O. / OEM	
<b>RAC23289-10</b>		593
<b>RAC23299-10</b>		593
<b>RAC320R-RAC-01</b>		593
<b>RAC320R-RAC-03</b>		593
<b>RAC490R-RAC-01</b>	99105-20005-ASY	593
<b>RACPF5510</b>		592
<b>RACRK22628</b>		594
<b>RACS3213</b>		593
<b>RACS3227</b>	99105-20005	593
<b>REC06192-ZY3-000</b>	HZY3-06192-000	605
<b>REC06192-ZY6-000</b>	HZY6-06192-000	605
<b>REC09401-11425</b>		591
<b>REC09401-11425BULK</b>		591
<b>REC10W30U3</b>		595
<b>REC10W30U6</b>		595
<b>REC10W40U3</b>	990C0-10W40-GLN	595
<b>REC10W40U6</b>	990C0-10W40-GLN	595
<b>REC15400-PLM-A01PE</b>	HPLM-15400-PE	596
<b>REC16157</b>	369-65011-0	605
<b>REC16159</b>	369-65025-0	605
<b>REC16253</b>	369-03231-0	597
<b>REC162532</b>	3C8-03125-0	597
<b>REC16275</b>	369-03303-0	596
<b>REC16325</b>	369-03306-0	596
<b>REC16911-ZY3-010</b>	HZY3-16911-010	595
<b>REC16911-ZZ5-003</b>	HZZ5-16911-003	595
<b>REC17109-ZY6-000</b>	HZY6-17109-000	621
<b>REC18-6865</b>		602
<b>REC19210-ZV5-003</b>	HZV5-19210-003	604
<b>REC19210-ZW1-B02</b>	HZW1-19210-B04	604
<b>REC19210-ZY3-003</b>	HZY3-19210-003	604
<b>REC19300-ZV5-043</b>	HZV5-19300-043	603
<b>REC22-8M0001721</b>		591
<b>REC24942</b>		592
<b>REC24950</b>		593
<b>REC24952</b>		593
<b>REC25000</b>		592
<b>REC25010</b>		592
<b>REC25020</b>		592
<b>REC25030</b>		592
<b>REC25W40U3</b>		595
<b>REC26-16051</b>	369-00122-0	608
<b>REC26-161301</b>	346-60111-0	618
<b>REC26-16162</b>	369-60223-0	618
<b>REC26-161622</b>	346-65013-0	618
<b>REC26-16703</b>	369-01215-0	618
<b>REC26-803514</b>	101-00121-0	609
<b>REC26-803667</b>	350-00121-0	618
<b>REC26-85370711</b>	3B2-00051-0	609
<b>REC26-8537072</b>	346-01215-0	618
<b>REC27-16274</b>	369-03302-0	596
<b>REC27-16326</b>	369-03307-0	596
<b>REC27-8555691</b>	3C8-04028-0	596
<b>REC2TU3</b>		595
<b>REC2TU6</b>		595
<b>REC30-16049</b>	9603-3-6204	608-609
<b>REC30-160494</b>	96603-3-6305	610
<b>REC30-16049T01</b>	345-00113-0	611
<b>REC30-898101936</b>	9643-3-6004	619
<b>REC30580-ZV4-013</b>	HZV4-30580-013	599
<b>REC309-01005-2</b>	309-01005-2	617
<b>REC31-16052</b>	350-00042-0	608-610-619
<b>REC31-8036752</b>	338-00042-0	609-619
<b>REC31-813048</b>	369-00043-0	608
<b>REC31-8130482</b>	356-00043-0	611
<b>REC31-855553</b>	3C8-00113-0	612
<b>REC31200-ZY6-003</b>	HZY6-31200-003	601
<b>REC345-00042-0</b>	345-00042-0	611-612-620
<b>REC345-65021-0</b>	345-65021-0	604
<b>REC346-01005-0</b>	346-01005-0	617
<b>REC346-01303-0</b>	350-01303-0	618
<b>REC35-802893Q</b>		592
<b>REC35-802893Q01</b>	3Y7-02234-0	592
<b>REC35-80365M</b>	646-24251-02	595
<b>REC350-01005-0</b>	350-01005-0	617
<b>REC350-01303-0</b>	350-01303-0	618
<b>REC350-61012-1</b>	350-61012-1	618
<b>REC351-01005-0</b>	351-01005-0	617
<b>REC353-06260-0</b>	353-06260-0	601
<b>REC353-06260-0</b>	353-06260-2	601
<b>REC35668-ZY6-003</b>	HZY6-35668-003	598
<b>REC369-06021-0</b>	369-06021-0	598
<b>REC37510-PNB-003</b>	HPNB-37510-003	598
<b>REC39-16054A5</b>	346-00011-0	611-620
<b>REC39-803678A1</b>	350-00011-0	610

REF	R.O. / OEM	
<b>REC39-803678A3</b>	3B2-00011-0	609-619
<b>REC39-8M0055809</b>	3V1-00011-0	615
<b>REC3A0-06040-1</b>	3A0-06040-1	599
<b>REC3A106-2602M</b>	3A106-2402M	601
<b>REC3A106-2602M</b>	3A106-2601M	601
<b>REC3A106-2602M</b>	3A106-2602M	601
<b>REC3B2-01005-0</b>	3B2-01005-0	617
<b>REC3B2-01303-0</b>	3B2-01303-0	618
<b>REC3B2-65021-1</b>	3B2-65021-1	604
<b>REC3B7-65021-2</b>	3B7-65021-2	604
<b>REC3B7-87121-1</b>	3B7-87121-7	617
<b>REC3C8-01005-4</b>	3C8-01005-4	617
<b>REC3C8-01024-0</b>	3C8-01024-0	617
<b>REC3C8-01303-4</b>	3C8-01303-4	618
<b>REC3C8-02104-0</b>	3C8-02104-0	621
<b>REC3C8-02305-0</b>	3C8-02305-0	621
<b>REC3F0-06060-0</b>	3F0-06060-0	601
<b>REC3F0-65029-6</b>	3F0-65029-6	605
<b>REC3F3-01005-0</b>	3F3-01005-0	617
<b>REC3F3-01024-0</b>	3F3-01024-0	617
<b>REC3F3-01303-1</b>	3F3-01303-1	618
<b>REC3F3-02104-0</b>	3F3-02104-0	621
<b>REC3F3-02305-1</b>	3F3-02305-1	604
<b>REC3G2-06040-2</b>	3G2-06040-2	599
<b>REC3G2-06060-2</b>	3G2-06060-2	601
<b>REC3G3-06021-1</b>	3G3-06021-1	598
<b>REC3T5-87121-6</b>	3T5-87121-6	617
<b>REC3T9-01005-0</b>	3T9-01005-0	617
<b>REC3T9-01032-0</b>	3T9-01032-0	604
<b>REC3T9-02104-0</b>	3T9-02104-0	621
<b>REC40135</b>		595
<b>REC40145</b>		595
<b>REC40155</b>		595
<b>REC40165</b>		595
<b>REC41-16056</b>	369-00021-0	608-619
<b>REC41-16056</b>	3C8-00021-0	612
<b>REC41-803680002</b>	350-00021-0	610-619
<b>REC41-803680003</b>	3C8-00021-0	611-620
<b>REC41-8036801</b>	3B2-00021-0	609-619
<b>REC41-825713002</b>	332-00021-0	610-619
<b>REC43-16138</b>	309-64020-0	626
<b>REC43-803739</b>	350-06401-0	626
<b>REC43-803739T03</b>	3H8-640100	626
<b>REC43-803740</b>	350-06401-0	626
<b>REC43-803740T02</b>	3H8-64020-0	626
<b>REC43-803741</b>	362-64215-0	626
<b>REC43-803741T03</b>	3H8-64030-0	626
<b>REC43-812944</b>	369-64010-2	626
<b>REC43-8129451</b>	369-64030-2	626
<b>REC44-195133</b>	369-64211-1	626
<b>REC45-161351</b>	369-64301-0	626
<b>REC45-803738</b>	350-64301-0	626
<b>REC45-8037381</b>	350-64302-0	626
<b>REC53-16057</b>	334-00024-1	611-612-620
<b>REC53-16057</b>	350-00024-1	608-609-610-619-620
<b>REC5GH-13440-00</b>	3R3R76150M	589-596
<b>REC5GH-13440-00</b>	3R0-07615-0	596
<b>REC5GH-13440-00</b>	5GH-13440-00	596
<b>REC5W40U3</b>		595
<b>REC5W40U6</b>		595
<b>REC629-803674</b>	350-00040-0	610-619
<b>REC629-8036741</b>	3B2-00040-0	609-619
<b>REC629-813047T01</b>	336-00040-1	611-620
<b>REC650-24351-51</b>		591
<b>REC66M-W0093-01</b>	3V1-87122-0	597
<b>REC696-W0093-00</b>	345-87122-4	597
<b>REC6A1-W0093-01</b>	3F0-87122-2	597
<b>REC6E5-24351-51</b>		591
<b>REC6G1-W0093-00</b>	369-87122-1	597
<b>REC6G1-W0093-00</b>	3B2-87122-0	597
<b>REC6H1-W0093-01-00</b>	346-87122-0	597
<b>REC6H3-W0093-02</b>	346-87122-0	597
<b>REC6H4-W0093-03</b>	3F3-87122-1	597
<b>REC6L2-W0093-00</b>	3G2-87122-2	597
<b>REC6L8-G3118-01</b>	332S62102-1	625
<b>REC70720</b>		594
<b>REC779-803677</b>	350-00001-0	619
<b>REC779-803677</b>	350-00001-1	610
<b>REC779-803677T02</b>	351-00001-1	610-619
<b>REC779-804886</b>	3B2-00001-0	609-619
<b>REC779-879194T01</b>	346-00001-1	611-620
<b>REC779-96152</b>	3C8-00001-3	620
<b>REC779-9615T</b>	369-00001-0	608-619
<b>REC779-9615T</b>	3C8-00001-3	612
<b>REC803673</b>	350-00061-0	610

REF	R.O. / OEM	
<b>REC803751</b>	350-65011-1	605
<b>REC804898</b>	3B2-63600-1	603
<b>REC80W90U3</b>	990A0-01E81-01Q	595
<b>REC80W90U6</b>	990A0-01E81-01Q	595
<b>REC813046002</b>	369-00061-0	608
<b>REC8130461</b>	334-00061-0	611
<b>REC84419M</b>	345-87122-0	597
<b>REC8537312</b>	350-04005-0	596
<b>REC855676002</b>	3R3-01030-0	589-603
<b>REC855686</b>		592
<b>REC879147796</b>	362-64211-0	626
<b>REC8M0065585</b>	350-01215-5	618
<b>REC8M0076368</b>	369-64301-0	626
<b>REC8M0080349</b>	346-00011-0	612-620
<b>REC8M0080357</b>	351-00011-0	608-610-619
<b>REC90340-08002</b>	332-60005-2	623
<b>REC90340-08020</b>	332-60006-0	623
<b>REC90794-46866</b>		594
<b>REC90794-46868</b>		594
<b>RECOBRACKET</b>		592
<b>RECOBELEMENT</b>		593
<b>RECOFILALU</b>		593
<b>RECOFILTER</b>		593
<b>RECYS-225-15</b>		594
<b>RM35-802893Q</b>		592
<b>RM92-858026QB1U6</b>		595
<b>RM92-858027QB1U3</b>		595
<b>RM92-8M0086220U6</b>		595
<b>RM92-8M0086221U3</b>		595
<b>S</b>		
<b>SIE18-8013</b>		590
<b>SIE18-8015</b>		590
<b>SOL3411-130-19</b>	3C7-64554-0	628
<b>SOL3411-130-21</b>		628
<b>SOL3411-133-17</b>	3C7-64541-0	628
<b>SOL3411-135-15</b>	3C7-64536-0	628
<b>SOL3411-138-13</b>	3B7-64527-1	628
<b>SOL3411-140-11</b>	3B7-64523-1	628
<b>SOL3413-125-19</b>	3C7-64554-0	628
<b>SOL3413-125-21</b>		628
<b>SOL3413-128-17</b>	3C7-64541-0	628
<b>SOL3413-130-15</b>	3C7-64536-0	628
<b>SOL3413-133-13</b>	3B7-64527-1	628
<b>SOL3431-130-19</b>	3C7-64554-0	628
<b>SOL3431-130-21</b>		628
<b>SOL3431-133-17</b>	3C7-64541-0	628
<b>SOL3431-135-15</b>	3C7-64536-0	628
<b>SOL5011-078-07</b>		628
<b>SOL5011-078-08</b>		628
<b>SOL5011-085-07</b>	3B2-64513-0	628
<b>SOL5011-085-08</b>	3B2-64515-0	628
<b>SOL5011-085-09</b>	3B2-64517-0	628
<b>SOL5111-093-07</b>	362-64105-0	628
<b>SOL5111-093-08</b>	362-64103-0	628
<b>SOL5111-093-09</b>	362-64101-0	628
<b>SOL5111-093-10</b>	362-64108-0	628
<b>SOL5111-093-11</b>		628
<b>SOL5211-099-09</b>	346-64101-5	628
<b>SOL5211-099-10</b>	346-64102-5	628
<b>SOL5211-099-11</b>	346-64103-5	628
<b>SOL5211-099-12</b>		628
<b>SOL5211-099-13</b>	346-64104-5	628
<b>SOL5311-110-15</b>	3E3-64536-0	628
<b>SOL5311-110-16</b>		628
<b>SOL5311-110-17</b>		628
<b>SOL5311-111-13</b>	3E3-64528-0	628
<b>SOL5311-111-14</b>	3E3-64536-0	628
<b>SOL5311-114-12</b>	348-64103-0	628
<b>SOL5311-116-11</b>	348-64102-0	628
<b>SOL5311-121-09</b>	361-64114-0	628
<b>SOL5311-122-07</b>		628
<b>SOL5313-105-13</b>	361-64113-0	628
<b>SOL5313-105-14</b>	3E3-64528-0	628
<b>SOL5313-108-12</b>	348-64103-0	628
<b>SOL5313-111-11</b>	348-64102-0	628
<b>SOL5313-118-09</b>	361-64114-0	628
<b>SOL9311-111-13</b>		629
<b>SOL9311-114-12</b>		629
<b>SOL9411-132-19</b>		629
<b>SOL9411-132-21</b>		629
<b>SOL9411-133-17</b>		629
<b>SOL9411-135-15</b>		629
<b>SOL9411-138-13</b>		629
<b>SOL9411-140-09</b>		629
<b>SOL9411-140-11</b>		629

REF	R.O. / OEM	REF	R.O. / OEM
SOL9431-130-19	629	SOL9571-148-23	629
SOL9431-130-21	629	SOL9571-150-21	629
SOL9431-133-17	629	SOL9571-153-19	629
SOL9431-135-15	629	SOL9571-155-17	629
SOL9431-138-13	629	SOL9571-158-15	629
SOL9432-130-19	629	SOL9572-148-23	629
SOL9432-133-17	629	SOL9572-150-21	629
SOL9432-135-15	629	SOL9572-153-19	629
SOL9432-138-13	629	SOL9572-155-17	629
SOL9511-143-21	629	SOL9572-158-15	629
SOL9511-145-19	629	SOLRBX-109	629
SOL9511-148-17	629	SOLRBX-112	629
SOL9511-150-15	629	SOLRBX-116	629
SOL9511-153-13	629		
SOL9511-155-11	629	TEN01250	338-60218-2 589-607
SOL9511-160-13	629	TEN01251	369-60218-1 607
SOL9531-140-19	629	TEN01252	348-60217-0 607
SOL9512-143-21	629	TEN01253	3C8-60217-1 589-607
SOL9512-145-19	629	TEN01254	3C7-60218-2 607
SOL9512-148-17	629	TEN01255	3B7-60217-0 607
SOL9512-150-15	629	TEN01256	3B7-60218-1 589-607
SOL9531-140-21	629	TEN01257	3M2-60218-0 607
SOL9531-140-23	629	TEN01258	5338602182A0 589-607
SOL9531-143-17	629	TEN01259	3H6-60218-0 589-607
SOL9531-145-15	629	TEN01260	3B7-60217-0 589-607
SOL9532-140-19	629	TEN01408	HZV4-12155-A00 607
SOL9532-140-21	629	TEN01408/1	HZV5-12155-000 607
SOL9532-140-23	629	TRI305-0386	590
SOL9532-143-17	629	TRI305-0566	590
SOL9532-145-15	629		

**RO / OEM --> REF**

R.O. / OEM	REF	R.O. / OEM	REF	R.O. / OEM	REF
101-00121-0	REC26-803514	346-64102-5	SOL5211-099-10	351-00011-0	REC8M0080357 608-610-619
172-36008-0	PAF8-05000003	346-64103-5	SOL5211-099-11	351-01005-0	REC351-01005-0 617
309-00131-0	PAT3.6-04000006	346-64104-5	SOL5211-099-13	353-06260-0	REC353-06260-0 601
309-01005-2	REC309-01005-2	346-65013-0	REC26-161622	353-06260-2	REC353-06260-0 601
309-60111-0	PAF8-04000101	346-67114-0	PAF8-05000018	353-76010-4	PH130-0048 600
309-64020-0	REC43-16138	346-76010-0M	PH130-0080	356-00043-0	REC31-8130482 611
309-65021-1	CEF500396	346-87122-0	REC6H1-W0093-01-00	361-64113-0	SOL5311-122-08 628
332-00021-0	PAF8-05020105	346-87122-0	REC6H3-W0093-02	361-64114-0	SOL5311-121-09 628
332-00021-0	REC41-825713002	348-60217-0	CM348-60217-0M	361-64114-0	SOL5313-118-09 628
332-00024-0	PAF8-05020105	348-60217-0	TEN01252	362-64101-0	SOL5111-093-09 628
332-60005-2	REC90340-08002	348-64102-0	SOL5311-116-11	362-64103-0	SOL5111-093-08 628
332-60006-0	REC90430-08020	348-64102-0	SOL5313-111-11	362-64105-0	SOL5111-093-07 628
332-62101-0	PAF4-01010003	348-64103-0	SOL5311-114-12	362-64108-0	SOL5111-093-10 628
332S62102-1	REC6L8-G3118-01	348-64103-0	SOL5313-108-12	362-64211-0	REC879147T96 626
334-00024-1	REC53-16057	350-00001-0	REC779-803677	362-64215-0	REC43-803741 626
334-00061-0	REC8130461	350-00001-1	REC779-803677	369-00001-0	REC779-9615T 608-619
334-65021-0	CEF500383	350-00011-0	REC39-803678A1	369-00021-0	REC41-16056 608-619
336-00040-1	REC629-813047T01	350-00021-0	REC41-803680002	369-00043-0	REC31-813048 608
338-00042-0	REC31-8036752	350-00024-1	PAF15-07020005	369-00061-0	REC813046002 608
338-60218-2	CM33860-2181	350-00024-1	REC53-16057	608-609-610-619-620	REC26-16051 608
338-60218-2	TEN01250	350-00040-0	REC629-803674	369-00132-0	PAF8-05000024 613
344-67177-0	PAGB/T7940.1-M6	350-00042-0	REC31-16052	369-01215-0	REC26-16703 618
345-00042-0	REC345-00042-0	350-00061-0	REC803673	369-02230-0	PAF4-05000300 595
345-00113-0	REC30-16049T01	350-00121-0	REC26-803667	369-03231-0	REC16253 597
345-62441-0	PAF8-01000100	350-01005-0	REC350-01005-0	369-03302-0	REC27-16274 596
345-65015-0	PAF8-04040002	350-01215-5	REC8M0065585	369-03303-0	REC16275 596
345-65021-0	CEF500382	350-01303-0	REC346-01303-0	369-03306-0	REC16325 596
345-65021-0	REC345-65021-0	350-01303-0	REC350-01303-0	369-03307-0	REC27-16326 596
345-65021-1	CEF500379	350-04005-0	REC8537312	369-06021-0	REC369-06021-0 598
345-87122-0	REC84419M	350-06401-0	REC43-803739	369-60111-0	PAF8-04040004 623
345-87122-4	REC696-W0093-00	350-06401-0	REC43-803740	369-60218-1	TEN01251 607
346-00001-1	REC779-879194T01	350-61012-1	REC350-61012-1	369-60223-0	REC26-16162 618
346-00011-0	REC39-16054A5	350-62121-1	PAF8-01010200	369-62122-2	PAF8-01010200 625
346-00011-0	REC8M0080349	350-62415-0	PAJASOF40435-022	369-62439-1	PAF8-01010105 625
346-01005-0	REC346-01005-0	350-62417-0	PAF8-01000002	369-64010-2	REC43-812944 626
346-01032-0	PAF8-05010005	350-62423-0	PAF8-01000001	369-64014-0	PAF8-04000012-1 623
346-01215-0	REC26-8537072	350-64301-0	REC45-803738	369-64015-0	PAF8-04000012-2 623
346-02230-0	PAF4-05000300	350-64302-0	REC45-8037381	369-64030-2	REC43-8129451 626
346-60111-0	REC26-161301	350-65011-1	REC803751	369-64032-0	PAF8-04000012 623
346-62421-1	PAF8-01010102	350-76010-0	PH130-0061	369-64121-0	PAF15-06000016 623
346-64101-5	SOL5211-099-09	351-00001-1	REC779-803677T02	369-64211-1	REC44-195133 626

R.O. / OEM	REF		R.O. / OEM	REF		R.O. / OEM	REF	
369-64223-0	PAF8-04000305	623	3B7-65021-2	REC3B7-65021-2	604	3R3R76150M	REC5GH-13440-00	589-596
369-64301-0	REC45-161351	626	3B7-87121-7	REC3B7-87121-1	617	3T5-06920-0	PAF8-05000011	613
369-64301-0	REC8M0076368	626	3C7-60218-2	TEN01254	607	3T5-10131-0	PAF4-04000019	615
369-65011-0	REC16157	605	3C7-64536-0	SOL3411-135-15	628	3T5-87121-6	REC3T5-87121-6	617
369-65021-1	CEF500377	589-604	3C7-64536-0	SOL3413-130-15	628	3T9-01005-0	REC3T9-01005-0	617
369-65025-0	REC16159	605	3C7-64536-0	SOL3431-135-15	628	3T9-01032-0	REC3T9-01032-0	604
369-66112-1	PAF8-01010104	625	3C7-64541-0	SOL3411-133-17	628	3T9-02104-0	REC3T9-02104-0	621
369-84398-0	PAF8-05000025	615	3C7-64541-0	SOL3413-128-17	628	3V1-00001-0	PAF8-05020101	615-620
369-87122-1	REC6G1-W0093-00	597	3C7-64541-0	SOL3431-133-17	628	3V1-00011-0	REC39-8M0055809	615
393-62437-0	PAF8-01010103	625	3C7-64554-0	SOL3411-130-19	628	3V1-00030-1	PAF8-05020001	615
394-702500M	GS31015	592	3C7-64554-0	SOL3413-125-19	628	3V1-00040-0	PAF8-05020200	615-620
398-62103-0	PAF4-01010002	625	3C7-64554-0	SOL3431-130-19	628	3V1-00121-0	PAF8-05010012	615
3A0-06040-1	REC3A0-06040-1	599	3C7-65021-1	CEF500388	604	3V1-01024-0	PAF8-05000002	615
3A0-76079-0	PAF8-05000006	613	3C7760-2181	CM3C760-2181	606	3V1-01303-0	PAF8-00000004	615
3A106-2402M	REC3A106-2602M	601	3C7760-2181	CM3C760-2181A	606	3V1-02010-1	PAF8-05000008	615
3A106-2601M	REC3A106-2602M	601	3C8-00001-3	REC779-96152	620	3V1-02011-0	PAF15-07000017	615
3A106-2602M	REC3A106-2602M	601	3C8-00001-3	REC779-9615T	612	3V1-02104-0	PAF8-05000009	615
3AA-05004-0	PAF8-05050004	616	3C8-00021-0	REC41-16056	612	3V1-02305-0	PAF8-05000100	615
3AA-05013-0	PAF8-05050018	616	3C8-00021-0	REC41-803680003	611-620	3V1-02305-0	PAF8-05010004	615
3AA-05019-0	PAF4-04130101	616	3C8-00113-0	REC31-855553	612	3V1-03952-0	PAF15-07000018	615
3AA-06021-0	PAF8-05000300	598-613	3C8-01005-4	REC3C8-01005-4	617	3V1-05104-1	PAF8-05050005	616
3AA-06060-0	PAF8-05000400	613	3C8-01024-0	REC3C8-01024-0	617	3V1-05259-0	PAF8-05050002	616
3AA-06060-00	PAF8-05000400	601	3C8-01303-4	REC3C8-01303-4	618	3V1-06023-0	PAF8-05090000W	599
3AA060600M	PAF8-05000400	601	3C8-02104-0	REC3C8-02104-0	621	3V1-06040-0	PAF8-05000500	599-613
3AA-06091-0	PAF8-05000600	613	3C8-02305-0	REC3C8-02305-0	621	3V1060400	PAF8-05000500	599
3AA-07203-0	PAF8-05030005	615	3C8-03125-0	REC162532	597	3V1060400M	PAF8-05000500	599
3AA-07225-0	PAF8-05030009	615	3C8-04028-0	REC27-8555691	596	3V1-06071-0	PAF8-05000200	599-613
3AA760100	PH130-0061	600	3C8-60217-1	CM3C8-60217-0	606	3V1-06302-0	PAF8-05000013	616
3AC-02230-0	PAF15-07080000	594	3C8-60217-1	TEN01253	589-607	3V1-06308-0	PAF8-05000012	616
3AD-02230-0	PAF15-07080000	594	3C8-62104-1	PAF4-01010005	625	3V1-07010-0	PAF8-05030008	615
3B1-66145-0	PAF8-03010007	623	3C8-66116-0	PAF8-03010006	623	3V1-07201-0	PAF8-05030001	615
3B2-00001-0	REC779-804886	609-619	3C8-76010-1	PH130-0006	600	3V1-07202-0	PAF8-05030002	615
3B2-00011-0	REC39-803678A3	609-619	3C8760101	PH130-0006	600	3V1-07205-0	PAF8-05030004	615
3B2-00021-0	REC41-8036801	609-619	3C8760101M	PH130-0006	600	3V1-07221-0	PAF8-05030006	615
3B2-00040-0	REC629-8036741	609-619	3E3-64528-0	SOL5311-111-13	628	3V1-07235-0	PAF8-05030200	615
3B2-00051-0	REC26-85370711	609	3E3-64528-0	SOL5313-105-13	628	3V1-07407-0	PAF8-05010009	615
3B2-01005-0	REC3B2-01005-0	617	3E3-64536-0	SOL5311-110-15	628	3V1-07410-0	PAF8-05000800	615
3B2-01215-0	PAF8-02000002	625	3E3-64536-0	SOL5311-111-14	628	3V1-07421-0	PAF8-00000200	615
3B2-01303-0	REC3B2-01303-0	618	3E3-64536-0	SOL5313-105-14	628	3V1-07440-0	PAF8-02000003	625
3B2-63600-1	REC804898	603	3F0-06060-0	REC3F0-06060-0	601	3V1-07600-0	PAF8-05030300	615
3B2-64010-0	PAF8-04010000	623-626	3F0-65029-6	REC3F0-65029-6	605	3V1-07653-0	PAF8-05030012	615
3B2-64020-0	PAF8-04000003	623-626	3F0-87122-2	REC6A1-W0093-01	597	3V1-10045-0	PAF8-05000014	589-615
3B2-64023-0	PAF8-04000004-1	623	3F3-01005-0	REC3F3-01005-0	617	3V1-10060-0	PAF8-05010014	615
3B2-64030-0	PAF8-04000014	623-626	3F3-01024-0	REC3F3-01024-0	617	3V1-10063-0	PAF8-05010015	615
3B2-64215-0	PAF8-04000303	623-626	3F3-01303-1	REC3F3-01303-1	618	3V1-10068-0	PAF8-05010016	615
3B2-64230-1	PAF8-04000019	623	3F3-02104-0	REC3F3-02104-0	621	3V1-60041-0	PAF8-04000016	623
3B2-64513-0	SOL5011-085-07	628	3F3-02305-1	REC3F3-02305-1	604	3V1-60042-0	PAF8-04000015	623
3B2-64515-0	SOL5011-085-08	628	3F3-87122-1	REC6H4-W0093-03	597	3V1-60211-0	PANSKFJ-1516	623
3B2-64517-0	SOL5011-085-09	628	3G2-06040-2	REC3G2-06040-2	599	3V1-61208-0	PAF8-02000005	625
3B2-65011-0	PAF8-04000010	605-623	3G2-06060-2	REC3G2-06060-2	601	3V1-61220-0	PAF8-02000004	625
3B2-65016-0	PAF8-04000009	623	3G2-87122-2	REC6L2-W0093-00	597	3V1-61301-1	PAF8-02000100	625
3B2-65016-0	PAF8-04000013	623	3G3-06021-1	REC3G3-06021-1	598	3V1-61302-0	PAF8-00000002	625
3B2-65018-0	PAF8-04000008	623	3H6-07223-0	PAF8-05030007	615	3V1-61313-0	PAF8-01000003	625
3B2-65020-0	PAF8-04000005	623	3H6-07611-0	PAF15-07010100	598-613	3V1-61324-0	PAGB/T889.1-M8	625
3B2-65021-1	CEF500344	589-604	3H6-07612-0	PAF15-07010101	613	3V1-61333-1	PAF8-00000100	625
3B2-65021-1	PAF8-04000200	623	3H6-60218-0	CM3H6-60218-000	606	3V1-63508-0	PAF8-05000020	623
3B2-65021-1	REC3B2-65021-1	604	3H6-60218-0	CM3H6-60218-000A	606	3V1-63622-0	PAF8-05000019	623
3B2-65022-0	PAF8-04000021	623	3H6-60218-0	TEN01259	589-607	3V1-64211-0	PAF8-04000301	623-626
3B2-65025-0	PAF8-04000007	605-623	3H8-02093-0	PAF8-05010002	615	3V1-64221-0	PAF8-04000302	623
3B2-65029-0	PAF8-04000006	623	3H8-07025-0	PAF8-05030011	615	3V1-64306-1	PAF8-04020001S	623-626
3B2-66113-0	PAF8-03010005	623	3H8-07226-0	PAF8-005030010	615	3V1-64307-1	PAF8-04020001L	623-626
3B2-66315-0	PAF8-01010109	625	3H8-07237-0	PAF15-07040304	615	3V1-65100-0	PAF8-02000006(S)	625
3B2-66321-1	PAF8-01010108	625	3H8-10062-2	PAF8-05030400	615	3V1-65110-0	PAF8-02000006(L)	625
3B2-702501M	GS31088	591	3H8-640100	REC43-803739T03	626	3V1-65203-0	PAF8-02000009	625
3B2-702601M	GS31018	592	3H8-64020-0	REC43-803740T02	626	3V1-65206-0	PAF8-02000007	625
3B2-702801M	GS31016	592	3H8-64030-0	REC43-803741T03	626	3V1-66187-0	PAF8-03010001	623
3B2-87122-0	REC6G1-W0093-00	597	3K9-05223-0	PAF8-01010112	625	3V1-66211-0	PAF8-03000010	623
3B2S60100-0	PAF8-04040000	623	3M2-60218-0	CM3M2-60218-1	606	3V1-66225-0	PAF8-03010003	623
3B2S60101-0	PAF8-04040001	623	3M2-60218-0	TEN01257	607	3V1-66302-0	PAF8-03000011	623
3B2W64517-0	PAF8-04050000	623	3R0-07238-0	PAF15-07040303	615	3V1-66313-0	PAF8-01010106	625
3B7-02230-0	PAF15-07080000	594	3R0-66308-0	PAF8-05000021	613	3V1-87122-0	REC66M-W0093-01	597
3B7-06305-0	PAF8-05000007	613	3R1-05003-1	PAF8-05050006	616	3V1602170	CM3V1-60217-0A	606
3B7-60217-0	CM3B7-602170	606	3R1-05007-0	PAF8-05050009	616	3V1602170	CM3V1-60217-0A	606
3B7-60217-0	TEN01255	607	3R1-05012-0	PAF8-05050007	616	3V1B01001-0	PAF8-05030100	615
3B7-60217-0	TEN01260	589-607	3R1-05125-0	PAF8-05050003	616	3V1B01100-0	PAF8-05010000	615
3B7-60218-1	CM3B7-60218-0	606	3R1-05131-0	PAF4-04130102	616	3V2-03100-2	PAF8-05040000	596
3B7-60218-1	TEN01256	589-607	3R3-01030-0	REC855676002	589-603	3Y7-02234-0	REC35-802893Q01	592
3B7-64523-1	SOL3411-140-11	628	3R3-07227-0	PAF8-05030015	615	5GH-13440-00	REC5GH-13440-00	596
3B7-64527-1	SOL3411-138-13	628	3R3-07405-1	PAF15-04000002	625	5338602182A0	CM5338602182A0	606
3B7-64527-1	SOL3413-133-13	628	3R3-07406-0	PAF15-04000003	625	5338602182A0	CM5338602182A0A	606
3B7-65021-2	CEF500388	604	3R3-61017-0	PAF8-00000003	615	5338602182A0	TEN01258	589-607

R.O. / OEM	REF	
646-24251-02	REC35-80365M	595
910113-0830	PAGB/T5783-M8X30	625
910184-5620	PAGB/T5783-M6X20	625
910184-5620	PAGB/T97.1-6	625
940113-0800	PAF8-02000100	625
940121-1200	PAT15-04000011	613
945303-0500	PAGB/T896-5	625
9603-3-6204	REC30-16049	608-609
9643-3-6004	REC30-898101936	619
96603-3-6305	REC30-160494	610
9701-1-1005	NGKB7HS-10	600
9701-1-1006	NGKB8HS-10	600
9701-1-1010	NGKBP7HS-10	600
9701-1-1013	NGKBPR6HS-10	600
9701-1-1014	NGKBPR7HS-10	600
9701-1-1015	NGKBR7HS-10	600
9701-1-1103	NGKDCPR6E	589-600
9701-1-1110	NGKBR8HS-10	600
9701-1-1111	NGKIZFR6	600
9701-1-1121	NGKIKR6G8	600
9791-1-1109	NGKIZFR5J	600
98AB-5-0330	PAF8-05000024	615
98AH10-0120	PAF8-05000017	615
990A0-01E81-01Q	REC80W90U3	595
990A0-01E81-01Q	REC80W90U6	595
990C0-10W40-GLN	REC10W40U3	595
990C0-10W40-GLN	REC10W40U6	595
99998-OMA2	GS31019	591
HPLM-15400-PE	REC15400-PLM-A01PE	596
HPNB-37510-003	REC37510-PNB-003	598
HZV4-12155-A00	TEN01408	607
HZV4-30580-013	REC30580-ZV4-013	599
HZV5-12155-000	TEN01408/1	607
HZV5-19210-003	CEF500338	604
HZV5-19210-003	REC19210-ZV5-003	604
HZV5-19300-043	REC19300-ZV5-043	603
HZW1-19210-B04	CEF500337	604
HZW1-19210-B04	REC19210-ZW1-B02	604
HZW9-19300-003	PAF15-07000031	603
HZY3-06192-000	REC06192-ZY3-000	605
HZY3-16911-010	REC16911-ZY3-010	595
HZY3-19210-003	CEF500391	604
HZY3-19210-003	REC19210-ZY3-003	604
HZY3-31200-003	PH130-0070	601
HZY6-06192-000	REC06192-ZY6-000	605
HZY6-17109-000	REC17109-ZY6-000	621
HZY6-31200-003	REC31200-ZY6-003	601
HZY6-35668-003	REC35668-ZY6-003	598
HZZ3-31909-003	NGKLMAR6C-9	600
HZZ5-16911-003	REC16911-ZZ5-003	595

# SELVA

## ES

GUÍA MANTENIMIENTO	636
<b>SISTEMA DE REFRIGERACIÓN</b>	638
<b>ÁNODOS</b>	638
ÁNODO CANADA METAL	638
ÁNODO TECNOSEAL	639
<b>IMPULSORES</b>	640
GUÍA IMPULSORES	640
<b>SISTEMA DE PROPULSIÓN</b>	641
<b>HÉLICES ALUMINIO E INOXIDABLE DE 3 Y 4 PALAS</b>	641
GUÍA HÉLICES CON NÚCLEO INTEGRADO	642
REF --> RO	643
RO --> REF	643

## IT

GUIDA MANUTENZIONE	636
<b>SISTEMA DI RAFFREDDAMENTO</b>	638
<b>ANODI</b>	638
ANODI CANADA METAL	638
ANODI TECNOSEAL	639
<b>GIRANTE</b>	640
GUIDA GIRANTE	640
<b>SISTEMA DI PROPULSIONE</b>	641
<b>ELICHE ALLUMINIO E INOX DA 2 E 4 PALE</b>	641
GUIDA ELICHE CON MOZZO	642
REF --> RO	643
RO --> REF	643

## EN

MAINTENANCE GUIDE	636
<b>COOLING SYSTEM</b>	638
<b>ANODES</b>	638
ANODES CANADA METAL	638
ANODES TECNOSEAL	639
<b>IMPELLERS</b>	640
IMPELLERS GUIDE	640
<b>PROPULSION SYSTEM</b>	641
<b>3 &amp; 4 BLADE ALUMINIUM &amp; SS PROPELLERS</b>	641
PROPELLERS APPLICATION WITH RUBBER HUB	642
REF --> OEM	643
OEM --> REF	643

## FR

GUIDE MAINTENANCE KITS	636
<b>SYSTÈME DE REFROIDISSEMENT</b>	638
<b>ANODES</b>	638
ANODE CANADA METAL	638
ANODE TECNOSEAL	639
<b>TURBINES</b>	640
GUIDE DE TURBINES	640
<b>SYSTEME DE PROPULSION</b>	641
<b>HÉLICE ALUMINIUM ET INOX 3 ET 4 PALES</b>	641
GUIDE DES HÉLICES ET MOYEURS	642
REF --> RO	643
RO --> REF	643

GUÍA  
MANTENIMIENTO

MAINTENANCE  
GUIDE

GUIDA  
MANUTENZIONE

GUIDE  
MAINTENANCE



REF

RAY8	NGKBR6HS-10	BUJÍA	SPARK PLUG	CANDELE	BOUGIE	2	
	CM6G8-11325-00	ÁNODO	ANODE	ANODO	ANODE	1	
	CM68T-45251-00	ÁNODO	ANODE	ANODO	ANODE	1	
	REC68T-44352-00	TURBINA	IMPELLER	GIRANTE	TURBINE	1	
	REC68T-24251-00	FILTRO COMBUSTIBLE	FUEL FILTER	FILTRO COMBUSTIBILE	FILTRE À ESSENCE	1	
	PAF15-07000031	TERMOSTATO	THERMOSTAT	TERMOSTATO	TERMOSTAT	1	
	REC68T-46241-00	CORREA DISTRIBIBUCIÓN	TIMING BELT	CINGHIE DISTRIBUZIONE	COURROIE DE DISTRIBUTION	1	
PIKE 9.9	NGKBR6HS-10	BUJÍA	SPARK PLUG	CANDELE	BOUGIE	2	
	CM6G8-11325-00	ÁNODO	ANODE	ANODO	ANODE	1	
	CM68T-45251-00	ÁNODO	ANODE	ANODO	ANODE	1	
	REC68T-44352-00	TURBINA	IMPELLER	GIRANTE	TURBINE	1	
	REC68T-24251-00	FILTRO COMBUSTIBLE	FUEL FILTER	FILTRO COMBUSTIBILE	FILTRE À ESSENCE	1	
	PAF15-07000031	TERMOSTATO	THERMOSTAT	TERMOSTATO	TERMOSTAT	1	
	REC68T-46241-00	CORREA DISTRIBIBUCIÓN	TIMING BELT	CINGHIE DISTRIBUZIONE	COURROIE DE DISTRIBUTION	1	
WAHOO 15/20	NGKDPR6EB-9	BUJÍA	SPARK PLUG	CANDELE	BOUGIE	2	
	CM6G8-11325-00	ÁNODO	ANODE	ANODO	ANODE	4	
	CM15026	ÁNODO	ANODE	ANODO	ANODE	1	
	TEN01123	ÁNODO	ANODE	ANODO	ANODE	1	
	TEN01154AL	ÁNODO	ANODE	ANODO	ANODE	1	
	REC63V-44352-01	TURBINA	IMPELLER	GIRANTE	TURBINE	1	
	REC61N-24563-10	FILTRO COMBUSTIBLE	FUEL FILTER	FILTRO COMBUSTIBILE	FILTRE À ESSENCE	1	
	REC5GH-13440-60	FILTRO DE ACEITE	OIL FILTER	FILTRO OLIO	FILTRE A HUILE	1	
	REC6AH-12411-00	TERMOSTATO	THERMOSTAT	TERMOSTATO	TERMOSTAT	1	
	PAF20-05000003	CORREA DISTRIBIBUCIÓN	TIMING BELT	CINGHIE DISTRIBUZIONE	COURROIE DE DISTRIBUTION	1	
KINGFISH 25	NGKDPR6EB-9	BUJÍA	SPARK PLUG	CANDELE	BOUGIE	2	
	CM6G8-11325-00	ÁNODO	ANODE	ANODO	ANODE	1	
	CM6BL-11325-00	ÁNODO	ANODE	ANODO	ANODE	2	
	CM6E0-45251-11A	ÁNODO	ANODE	ANODO	ANODE	1	
	CM62Y-11325-00	ÁNODO	ANODE	ANODO	ANODE	1	
	CM61N-45251-01	ÁNODO	ANODE	ANODO	ANODE	1	
	PAF25-04000021	ANODO TAB,TRIM	ANODE TAB,TRIM	ANODO TAB,TRIM	ANODE TAB,TRIM	1	
	REC6H4-44352-02	TURBINA	IMPELLER	GIRANTE	TURBINE	1	
	REC61N-24563-10	FILTRO COMBUSTIBLE	FUEL FILTER	FILTRO COMBUSTIBILE	FILTRE À ESSENCE	1	
	REC5GH-13440-60	FILTRO DE ACEITE	OIL FILTER	FILTRO OLIO	FILTRE A HUILE	1	
	PAF15-07000031	TERMOSTATO	THERMOSTAT	TERMOSTATO	TERMOSTAT	1	
	REC6C5-46241-00	CORREA DISTRIBIBUCIÓN	TIMING BELT	CINGHIE DISTRIBUZIONE	COURROIE DE DISTRIBUTION	1	
	ARUANA EFI 40	NGKDPR6EB-9	BUJÍA	SPARK PLUG	CANDELE	BOUGIE	3
		CM6G8-11325-00	ÁNODO	ANODE	ANODO	ANODE	4
CM688-45251-01		ANODO (Modelos S)	ANODE (S Models)	ANODO (Modelli S)	ANODE (Modèles S)	1	
CM6E0-45251-11A		ÁNODO	ANODE	ANODO	ANODE	1	
CM67C-45371-00		ÁNODO	ANODE	ANODO	ANODE	1	
CM67C-45251-00		ÁNODO	ANODE	ANODO	ANODE	1	
CM62Y-11325-00		ÁNODO	ANODE	ANODO	ANODE	1	
REC6H4-44352-02		TURBINA	IMPELLER	GIRANTE	TURBINE	1	
REC6D8-WS24A-00		FILTRO COMBUSTIBLE	FUEL FILTER	FILTRO COMBUSTIBILE	FILTRE À ESSENCE	1	
REC5GH-13440-60		FILTRO DE ACEITE	OIL FILTER	FILTRO OLIO	FILTRE A HUILE	1	
PAF15-07000031		TERMOSTATO	THERMOSTAT	TERMOSTATO	TERMOSTAT	1	
REC6C5-46241-00		CORREA DISTRIBIBUCIÓN	TIMING BELT	CINGHIE DISTRIBUZIONE	COURROIE DE DISTRIBUTION	1	
DORADO EFI 40XS-XRS, 50 /60 XS&XSR		NGKDPR6EB-9	BUJÍA	SPARK PLUG	CANDELE	BOUGIE	4
	PAF15-07000031	ÁNODO	ANODE	ANODO	ANODE	1	
	CM62Y-11325-00	ÁNODO	ANODE	ANODO	ANODE	1	
	CM6G8-11325-00	ÁNODO	ANODE	ANODO	ANODE	4	
	CM6E0-45251-11A	ÁNODO	ANODE	ANODO	ANODE	3	
	CM67C-45371-00	ÁNODO	ANODE	ANODO	ANODE	1	
	CM67C-45251-00	ÁNODO	ANODE	ANODO	ANODE	1	
	REC6H3-44352-00	TURBINA	IMPELLER	GIRANTE	TURBINE	1	
	REC6D8-WS24A-00	FILTRO COMBUSTIBLE	FUEL FILTER	FILTRO COMBUSTIBILE	FILTRE À ESSENCE	1	
	REC5GH-13440-60	FILTRO DE ACEITE	OIL FILTER	FILTRO OLIO	FILTRE A HUILE	1	
	PAF15-07000031	TERMOSTATO	THERMOSTAT	TERMOSTATO	TERMOSTAT	1	
	REC6C5-46241-00	CORREA DISTRIBIBUCIÓN	TIMING BELT	CINGHIE DISTRIBUZIONE	COURROIE DE DISTRIBUTION	1	



REF

MURENA EFI 40XSR/ 70	NGKLR7E	BUJÍA	SPARK PLUG	CANDELE	BOUGIE	4
	CM62Y-11325-00	ÁNODO	ANODE	ANODO	ANODE	1
	CM6G8-11325-00	ÁNODO	ANODE	ANODO	ANODE	3
	CM6E0-45251-11A	ÁNODO	ANODE	ANODO	ANODE	3
	CM67F-45371-00	ANODO TAB,TRIM	ANODE TAB,TRIM	ANODO TAB,TRIM	ANODE TAB,TRIM	1
	REC6H3-44352-00	TURBINA	IMPELLER	GIRANTE	TURBINE	1
	REC6D8-WS24A-00	FILTRO COMBUSTIBLE	FUEL FILTER	FILTRO COMBUSTIBILE	FILTRE À ESSENCE	1
	REC5GH-13440-60	FILTRO DE ACEITE	OIL FILTER	FILTRO OLIO	FILTRE A HUILE	1
	PAF15-07000031	TERMOSTATO	THERMOSTAT	TERMOSTATO	TERMOSTAT	1
REC6C5-46241-00	CORREA DISTRIBIBUCIÓN	TIMING BELT	CINGHIE DISTRIBUZIONE	COURROIE DE DISTRIBUTION	1	
MARLIN EFI 100/ 100XSR	NGKLR5A-11	BUJÍA	SPARK PLUG	CANDELE	BOUGIE	4
	CM15026	ÁNODO	ANODE	ANODO	ANODE	3
	CM67F-11325-01	ÁNODO	ANODE	ANODO	ANODE	2
	CM6H1-45251-02	ÁNODO	ANODE	ANODO	ANODE	1
	CM67F-45371-00	ANODO TAB,TRIM	ANODE TAB,TRIM	ANODO TAB,TRIM	ANODE TAB,TRIM	1
	REC67F-44352-00	TURBINA	IMPELLER	GIRANTE	TURBINE	1
	REC6D8-WS24A-00	FILTRO COMBUSTIBLE	FUEL FILTER	FILTRO COMBUSTIBILE	FILTRE À ESSENCE	1
	REC5GH-13440-00	FILTRO DE ACEITE	OIL FILTER	FILTRO OLIO	FILTRE A HUILE	1
	REC6D9-12411-00	TERMOSTATO	THERMOSTAT	TERMOSTATO	TERMOSTAT	1
REC67F-46241-00	CORREA DISTRIBIBUCIÓN	TIMING BELT	CINGHIE DISTRIBUZIONE	COURROIE DE DISTRIBUTION	1	
TARPON EFI 115/ 115XSR	NGKLR6A-11	BUJÍA	SPARK PLUG	CANDELE	BOUGIE	4
	CM15026	ÁNODO	ANODE	ANODO	ANODE	3
	CM67F-11325-01	ÁNODO	ANODE	ANODO	ANODE	2
	CM6G5-45251-01A	ÁNODO	ANODE	ANODO	ANODE	1
	CM6E5-45371-01A	ANODO TAB,TRIM	ANODE TAB,TRIM	ANODO TAB,TRIM	ANODE TAB,TRIM	1
	REC6E5-44352-01	TURBINA	IMPELLER	GIRANTE	TURBINE	1
	REC6D8-WS24A-00	FILTRO COMBUSTIBLE	FUEL FILTER	FILTRO COMBUSTIBILE	FILTRE À ESSENCE	1
	REC5GH-13440-00	FILTRO DE ACEITE	OIL FILTER	FILTRO OLIO	FILTRE A HUILE	1
	REC60V-12411-00	TERMOSTATO	THERMOSTAT	TERMOSTATO	TERMOSTAT	1
REC67F-46241-00	CORREA DISTRIBIBUCIÓN	TIMING BELT	CINGHIE DISTRIBUZIONE	COURROIE DE DISTRIBUTION	1	
KILLER WHALE EFI 150/ 150XSR	NGKLR5A-11	BUJÍA	SPARK PLUG	CANDELE	BOUGIE	4
	TEN01165	ÁNODO	ANODE	ANODO	ANODE	1
	CM63P-11325-01	ÁNODO	ANODE	ANODO	ANODE	1
	CM68T-11325-00	ÁNODO	ANODE	ANODO	ANODE	8
	CM63P-11325-11	ÁNODO	ANODE	ANODO	ANODE	4
	CM6G5-45251-01A	ÁNODO	ANODE	ANODO	ANODE	1
	CM67F-11325-01	ÁNODO	ANODE	ANODO	ANODE	2
	CM6J9-45371-01	ANODO TAB,TRIM R	ANODE TAB,TRIM R	ANODO TAB,TRIM R	ANODE TAB, TRIM R	1
	CM6K1-45371-02	ANODO TAB,TRIM L	ANODE TAB,TRIM L	ANODO TAB,TRIM L	ANODE TAB, TRIM L	1
	REC6E5-44352-01	TURBINA	IMPELLER	GIRANTE	TURBINE	1
	REC6P3-WS24A-00	FILTRO COMBUSTIBLE	FUEL FILTER	FILTRO COMBUSTIBILE	FILTRE À ESSENCE	1
	REC35-822626Q15	FILTRO DE ACEITE	OIL FILTER	FILTRO OLIO	FILTRE A HUILE	1
	REC67F-12411-01	TERMOSTATO	THERMOSTAT	TERMOSTATO	TERMOSTAT	1
REC63P-46241-00	CORREA DISTRIBIBUCIÓN	TIMING BELT	CINGHIE DISTRIBUZIONE	COURROIE DE DISTRIBUTION	1	

SELVA

RECAMBIOS  
MARINOS

# SISTEMA DE REFRIGERACIÓN COOLING SYSTEM

# SISTEMA DI RAFFREDDAMENTO SYSTÈME DE REFROIDISSEMENT



## ÁNODO

## ANODE

## ANODI

## ANODE

ZN	KG	AL	KG	OEM
CM55321-94900	0,51	CM55321-94900A	0,11	55320-94900

70, 90, 115, 140, 150 HP

ZN	KG	OEM
CM55320-98400	0,05	41811-98400

9.9 - 15 HP

ZN	KG	OEM
CM2504015	0,39	2504015

40 - 100 HP

ZN	KG	OEM
CM41811-98500	0,05	41811-98500

2.2 - 4 HP

ZN	KG	OEM
CM9005665	0,11	9005665

40 - 100 HP

ZN	KG	OEM
CM67C-45251-00	0,12	58.67C4525100

ZN	KG	OEM
CM2500010	0,10	2500010

6 - 8 - 9.9 - 15 HP

ZN	KG	OEM
CM2500065	0,10	2500065

25 - 40 HP

ZN	KG	OEM
CM9005655	0,03	9005655

ZN	KG	OEM
CM2500050	0,17	2500050

BEST 800 - S1000

ZN	KG	OEM
CM9005660	0,03	90056660

ZN	KG	OEM
CM55300-95500	0,08	55300-95500

2 - 8 HP



ZN	KG (kg)	OEM
CM82795M	0,20	25040151

25 - 30 HP



ZN	KG (kg)	OEM
CM2504020	0,21	405 - 700
CM2504025	0,31	100 hp
CM2504035	0,10	80 HP IZMIR 15 HP NAXOS



**ÁNODO ANODE ANODI ANODE**

ZN	KG (kg)	OEM
TEN01914	0,07	

80 - 100 HP



ZN	KG (kg)	OEM
TEN01902	0,10	2500010

Serie 6 8 - 9.9 - 15 HP



ZN	KG (kg)	OEM
TEN01915	0,10	



ZN	KG (kg)	OEM
TEN01903	0,20	2500050

Serie BEST 800 - S1000



ZN	KG (kg)	OEM
TEN01916	0,12	3C8-60217-1



ZN	KG (kg)	OEM
TEN01904	0,10	2504030

Serie 6 HP



ZN	KG (kg)	OEM
TEN01900	0,03	9005655

Serie PIATTA FB



ZN	KG (kg)	OEM
TEN01905	0,14	9005665



ZN	KG (kg)	OEM
TEN01901	0,03	9005660

Serie CURVA FB



ZN	KG (kg)	OEM
TEN01909	0,40	2504015



ZN	KG (kg)	OEM
TEN01906	0,07	2500065

Serie 25 - 40 HP



ZN	(KG)	OEM
TEN01907	0,14	2504025

Serie 100 HP



ZN	(KG)	OEM
TEN01912	0,10	2504035

Serie IZMIR 8 CV - NAXOS 15 CV



ZN	(KG)	OEM
TEN01908	0,21	2504020

Serie S405 - S700



ZN	(KG)
TEN01913	0,22

Serie MANTA BARRACUDA



IMPULSORES	IMPELLERS	GIRANTE	TURBINES
GUÍA DE IMPULSORES	IMPELLER GUIDE	GUIDA GIRANTE	GUIDE DES TURBINES

	2T STROKES	4T STROKES	REF	CEF	A (mm)	B (mm)	C (mm)
2.5		✓		CEF500376	12,2	48,5	15
3.5, 4	✓			CEF500376	12,2	48,5	15
5/6 OYSTER		✓		CEF500375	12	43	12
7.5 BLACK BASS		✓		CEF500375	12,2	43	12
8 RAY		✓	REC68T-44352-00	CEF500368	11,6	53	14
6, 8/9.9		✓		CEF500387	13,2	48	15
9.9 PIKE		✓	REC63V-44352-01	CEF500363	12,85	53	14
9.9, 15	✓			CEF500387	13,2	48	15
15, 20 WAHOO		✓	REC63V-44352-01	CEF500363	12,85	53	14
25 KINGFISH		✓	REC6H4-44352-02	CEF500385G	16,1	51,2	19,05
25, 30, 35	✓			CEF500386	15,2	53	20,5
40 ARUANA EFI		✓	REC6H4-44352-02	CEF500385G	16,1	51,2	19,05
40, 500 60 DORADO XS-R-EFI		✓	REC6H3-44352-00	CEF500316	18,05	51,8	19
40, 50, 60, 70, 80	✓			CEF500304	18,2	58,62	22,5
80, 100 MARLIN EFI		✓	REC67F-44352-00	CEF500364	20	58,2	34,7
115, 150, 200, 225, 250 EFI		✓	REC6E5-44352-01	CEF500371	22,4	89,3	31

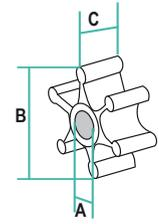

REC6E5-44352-01



REC68T-44352-00

REC63V-44352-01

REC6H4-44352-02

REC6H3-44352-00

REC67F-44352-00

# SISTEMA DE PROPULSIÓN PROPULSION SYSTEM

# SISTEMA DI PROPULSIONE SYSTEME DE PROPULSION

HÉLICES ALUMINIO E INOXIDABLE DE 3 Y 4 PALAS	3 & 4 BLADE ALUMINIUM & SS PROPELLERS	ELICHE ALLUMINIO E INOX DA 3 E 4 PALE	HELICE ALUMINIUM ET INOX 3 ET 4 PALES
CÓDIGO DE REFERENCIAS	PART NO. CODING SYSTEM	SISTEMA DI CODICE	CODAGE DES REFERENCES
<b>1</b> 1. Mercury, Mariner 2. Johnson, Evinrude 3. Yamaha 4. Suzuki 5. Tohatsu 6. 7. 8. Volvo Penta 9. Rubex System	<b>2</b> 0.5, 6, 8 and 9.8 HP Group 1. A Group 2. B Group 3. C Group 4. D Group 5. E Group 6. F Group 7. VP (Std. Hub) 8. VP (Long Hub)	<b>3</b> 1. AL 2. Saturn (INOX   Stainless Steel) 3. New Saturn (INOX   Stainless Steel) 4. Titan (INOX   Stainless Steel) 5. HR Titan (INOX   Stainless Steel) 6. Scorpion (INOX   Stainless Steel) 7. Lexor (INOX   Stainless Steel)	<b>4</b> 1. 3R Rubber Hub 2. 3L Rubber Hub 3. 4R Rubber Hub 4. 4L Rubber Hub



## AMITA 3



Hélice de aluminio con núcleo de goma de gran resistencia.

Aluminum propeller with heavy duty rubber hub.

Eliche di alluminio con mozzi in gomma ad alta resistenza.

Hélice en aluminium avec moyeu en caoutchouc



## AMITA 4



Hélices de aluminio con núcleo de goma de gran resistencia. Van muy suaves a poca velocidad y hace el barco muy manejable con la mar picada.

Aluminum propeller with heavy duty rubber hub. Smoother low speed makes the offshore boating activity much easier.

Eliche di alluminio con mozzo in gomma ad alta resistenza. Molto morbido a bassa velocità e rende la barca molto maneggevole con mare cattivo.

Hélice en aluminium avec moyeu en caoutchouc. Permet d'aller doucement à basse vitesse et rende le bateau très maniable lorsque la mer est agitée



## NEW SATURN



Hélices de acero inoxidable. Ofrece buena aceleración y rendimiento. Tamaño más pequeño que ofrece un diámetro extragrande.

Stainless steel propeller. Offers good acceleration & all-round performance. Smaller pitch sizes offered in extra large diameter with increased blade area.

Eliche di acciaio inox. Buona accelerazione. Piccole dimensioni che offre un più grande diametro.

Hélice inox, offrant de bonnes accélérations et performances. Taille de pas réduite pour les modèles de grands diamètres avec une surface de pale plus importante.

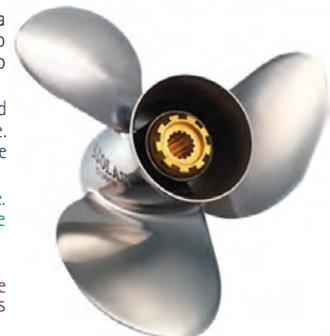

**GUÍA DE HÉLICES  
CON NÚCLEO INTEGRADO**

**PROPELLERS APPLICATION  
WITH RUBBER HUB**

**GUIDA ELICHE  
CON MOZZO**

**GUIDE DES HELICES ET  
MOYEURS**

	2T STROKES	4T STROKES	R.O. OEM	A	B	D	P	R	AL		INOX STAINLESS STEEL
									AMITA 3	AMITA 4	NEW SATURN
RAY 8	✓		6G1-45947-00-EL 6G1-45943-00-EL 6G1-45941-00-EL	3		8 <sup>1/2</sup>	6 <sup>1/2</sup> 7 <sup>1/2</sup> 8 <sup>1/2</sup>	R	SOL3011-085-07 SOL3011-085-08 SOL3011-085-09		
SELVA 9.9 / 15 HP	✓		2501300	3		10 9 <sup>1/4</sup>	7 8 9	R	SOL2111-093-07 SOL2111-093-08 SOL2111-093-09 SOL2111-093-10 SOL2111-093-11		
DOLPHIN 9.9 (S) DOLPHIN 9.9 (L) DOLPHIN 15	✓		683-45947-00-EL 683-45945-00-EL 683-45952-00-EL	3		9 <sup>1/4</sup>	8 9 9 <sup>3/4</sup>	R	SOL3111-093-08 SOL3111-093-09 SOL3111-093-10		
ANTIBES 20xs ANTIBES 25 ANTIBES 30 MAIORCA 35	✓		2505500 2505520 2505570			10 <sup>1/2</sup>	11 12 12.5	R	SOL2211-105-11 SOL2211-103-12 SOL2211-101-13		
MORAY 25	✓		664-45945-00-EL	3		9 <sup>7/8</sup>	10 <sup>1/2</sup> 9 <sup>7/8</sup> 11 <sup>1/4</sup> 12 13 10 <sup>1/2</sup> 10 <sup>1/4</sup> 10 <sup>1/8</sup>	R	SOL3211-099-10 SOL3211-099-11 SOL3211-099-12 SOL3211-099-13		SOL3231-105-11 SOL3231-103-12 SOL3231-101-13
MADEIRA 40 MADEIRA 40/50 ST. TROPEZ 40 ST. TROPEZ 40/60	✓		2505895 2506050 2506060	3		12 <sup>1/2</sup> 12 <sup>1/4</sup> 11 <sup>3/4</sup>	14 15 17	R	SOL2311-125-14 SOL2311-123-15 SOL2311-120-17		
MANTA 40 BARRACUDA 50/40 DORADO 60/40	✓		663-45956-01-EL 663-45947-02-EL 663-45952-02-EL 663-45945-02-EL 663-45958-01-EL 663-45943-02-EL 663-45949-01-EL 663-45941-01-EL	3		12 <sup>1/4</sup> 11 <sup>5/8</sup> 11 <sup>3/4</sup> 11 <sup>1/8</sup> 11 <sup>1/4</sup> 11 10 <sup>3/4</sup> 11 11 <sup>3/8</sup> 11 <sup>1/8</sup> 11 <sup>1/8</sup>	9 11 12 13 14 15 16 17 10 11 12 13 14	R	SOL3311-121-09 SOL3311-116-11 SOL3311-114-12 SOL3311-111-13 SOL3311-111-14 SOL3311-110-15 SOL3311-110-16 SOL3311-110-17		SOL3331-119-10 SOL3331-116-11 SOL3331-114-12 SOL3331-111-13 SOL3331-111-14
TENERIFE 70 BEST 800 PORTOFIN 70 PORTOFINO 75xs PORTOFINO 80 SUPERBEST 1000 MONTECARLO 90 MONTECARLO 100	✓		2505860 2505860 2506020 2506020 2506020 2505840 2506030 2506030	3		14 14 13 <sup>3/4</sup> 14 14 14 13 <sup>3/4</sup> 13 <sup>3/8</sup> 13 12 <sup>3/4</sup>	11 13 15 17 19 21 15 17 19 21	R	SOL2411-140-11 SOL2411-138-13 SOL2411-135-15 SOL2411-133-17 SOL2411-130-19 SOL2411-130-21	SOL2413-133-13 SOL2413-130-15 SOL2413-128-17 SOL2413-125-19 SOL2413-125-21	SOL2431-135-15 SOL2431-133-17 SOL2431-130-19 SOL2431-130-21 SOL2431-135-15 SOL2431-133-17 SOL2431-130-19 SOL2431-130-21
MARLIN 100 NARWHAL 115	✓		6E5-45954-00-EL 6E5-45949-00-EL 6E5-45947-00-EL 6E5-45945-00-EL 6E5-45941-00-EL 6E5-45943-00-EL 688-45978-90-98 688-45930-02-98 688-45970-03-98 688-45972-02-98	3		14 13 <sup>5/8</sup> 13 <sup>1/8</sup> 13 <sup>1/2</sup> 13 <sup>1/2</sup> 13 <sup>1/4</sup> 13 13 <sup>1/2</sup> 13 13 13	11 13 13 15 15 17 19 21 15 17 19 21	R R L R R L R R R R R	SOL3411-140-11 SOL3411-138-13 SOL3412-138-13 SOL3411-135-15 SOL3412-135-15 SOL3411-133-17 SOL3412-133-17 SOL3413-125-19 SOL3411-130-21 SOL3413-125-21	SOL3413-133-13 SOL3413-130-15 SOL3413-128-17	SOL3431-135-15 SOL3431-133-17 SOL3431-130-19 SOL3431-130-21
WHITE SHARK 150 HPDFI	✓		6G5-45941-00-98 6G5-45952-00-98 6G5-45947-01-98 6K1-45947-00-98 6G5-45945-01-98 6K1-45945-01-98 6G5-45949-00-98 6G5-45949-00-98	3		15 15 14,8 14,8 14,5 14,5 14,3 14,3 14,2	15 15 17 17 19 19 21 21 23 23	R L R L R L R L R L	SOL3511-150-15 SOL3512-150-15 SOL3511-148-17 SOL3512-148-17 SOL3511-145-19 SOL3512-145-19 SOL3511-143-21 SOL3512-143-21 SOL3511-142-23 SOL3512-142-23	SOL3513-148-15 SOL3514-148-15 SOL3513-145-17 SOL3514-145-17 SOL3513-143-19 SOL3514-143-19 SOL3513-140-21 SOL3514-140-21	

# REF--> RO / OEM

REF	R.O. / OEM	REF	R.O. / OEM	
<b>C</b>		SOL2413-125-21	2505840	642
CEF500304		SOL2413-128-17	2506020	642
CEF500316		SOL2413-130-15	2506020	642
CEF500363		SOL2413-133-13	2505860	642
CEF500364		SOL2431-130-19	2506020	642
CEF500368		SOL2431-130-21	2505840	642
CEF500371		SOL2431-133-17	2506020	642
CEF500375		SOL2431-133-17	2506030	642
CEF500376		SOL2431-135-15	2506020	642
CEF500385G		SOL2431-135-15	2506030	642
CEF500386		SOL3011-085-07	6G1-45947-00-EL	642
CEF500387		SOL3011-085-08	6G1-45943-00-EL	642
CM15026		SOL3011-085-09	6G1-45941-00-EL	642
CM2500010	2500010	SOL3111-093-08	683-45947-00-EL	642
CM2500050	2500050	SOL3111-093-09	683-45945-00-EL	642
CM2500065	2500065	SOL3111-093-10	683-45952-00-EL	642
CM2504015	2504015	SOL3211-099-10	664-45945-00-EL	642
CM2504020		SOL3211-099-11		642
CM2504025		SOL3211-099-12		642
CM2504035		SOL3211-099-13		642
CM41811-98500	41811-98500	SOL3231-101-13		642
CM55300-95500	55300-95500	SOL3231-103-12		642
CM55320-98400	41811-98400	SOL3231-105-11		642
CM55321-94900	55320-94900	SOL3311-110-15	663-45943-02-EL	642
CM55321-94900A	55320-94900	SOL3311-110-16	663-45949-01-EL	642
CM61N-45251-01		SOL3311-110-17	663-45941-01-EL	642
CM62Y-11325-00		SOL3311-111-13	663-45945-02-EL	642
CM63P-11325-01		SOL3311-111-14	663-45958-01-EL	642
CM63P-11325-11		SOL3311-114-12	663-45952-02-EL	642
CM67C-45251-00	58.67C4525100	SOL3311-116-11	663-45947-02-EL	642
CM67C-45371-00		SOL3311-121-09	663-45956-01-EL	642
CM67F-11325-01		SOL3331-111-13		642
CM67F-45371-00		SOL3331-111-14		642
CM688-45251-01		SOL3331-114-12		642
CM68T-11325-00		SOL3331-116-11		642
CM68T-45251-00		SOL3331-119-10		642
CM6BL-11325-00		SOL3411-130-19	6E5-45941-00-EL	642
CM6E0-45251-11A		SOL3411-130-21	6E5-45943-00-EL	642
CM6E5-45371-01A		SOL3411-133-17	6E5-45945-00-EL	642
CM6G5-45251-01A		SOL3411-135-15	6E5-45947-00-EL	642
CM6G8-11325-00		SOL3411-138-13	6E5-45949-00-EL	642
CM6H1-45251-02		SOL3411-140-11	6E5-45954-00-EL	642
CM6J9-45371-01		SOL3412-133-17		642
CM6K1-45371-02		SOL3412-135-15		642
CM82795M	25040151	SOL3412-138-13		642
CM9005655	9005655	SOL3413-125-19	6E5-45941-00-EL	642
CM9005660	9005660	SOL3413-125-21	6E5-45943-00-EL	642
CM9005665	9005665	SOL3413-128-17	6E5-45945-00-EL	642
<b>N</b>		SOL3413-130-15	6E5-45947-00-EL	642
NGKBR6HS-10	636	SOL3413-133-13	6E5-45949-00-EL	642
NGKDR6EB-9	636	SOL3431-130-19	688-45970-03-98	642
NGKLF6A-11	637	SOL3431-130-21	688-45972-02-98	642
NGKLF6A-11	637	SOL3431-133-17	688-45930-02-98	642
NGKLF6A-11	637	SOL3431-135-15	688-45978-90-98	642
NGKLF6A-11	637	SOL3511-142-23	6G5-45949-00-98	642
<b>P</b>		SOL3511-143-21	6G5-45949-00-98	642
PAF15-07000031	636-637	SOL3511-145-19	6G5-45945-01-98	642
PAF20-05000003	636	SOL3511-148-17	6G5-45947-01-98	642
PAF25-04000021	636	SOL3511-150-15	6G5-45941-00-98	642
<b>R</b>		SOL3512-142-23		642
REC35-822626Q15	637	SOL3512-143-21		642
REC5GH-13440-00	637	SOL3512-145-19	6K1-45945-01-98	642
REC5GH-13440-60	636-637	SOL3512-148-17	6K1-45947-00-98	642
REC60V-12411-00	637	SOL3512-150-15	6G5-45952-00-98	642
REC61N-24563-10	636	SOL3513-140-21	6G5-45949-00-98	642
REC63P-46241-00	637	SOL3513-143-19	6G5-45945-01-98	642
REC63V-44352-01	636-640	SOL3513-145-17	6G5-45947-01-98	642
REC67F-12411-01	637	SOL3513-148-15	6G5-45941-00-98	642
REC67F-44352-00	637-640	SOL3514-140-21		642
REC67F-46241-00	637	SOL3514-143-19	6K1-45945-01-98	642
REC68T-24251-00	636	SOL3514-145-17	6K1-45947-00-98	642
REC68T-44352-00	636-640	SOL3514-148-15	6G5-45952-00-98	642
REC68T-46241-00	636	<b>I</b>		
REC6AH-12411-00	636	TEN01123		636
REC6C5-46241-00	636-637	TEN01154AL		636
REC6D8-WS24A-00	636-637	TEN01165		637
REC6D9-12411-00	637	TEN01900	9005655	639
REC6E5-44352-01	637-640	TEN01901	9005660	639
REC6H3-44352-00	636-637-640	TEN01902	2500010	639
REC6H4-44352-02	636-640	TEN01903	2500050	639
REC6P3-WS24A-00	637	TEN01904	2504030	639
<b>S</b>		TEN01905	9005665	639
SOL2111-093-07	2501300	TEN01906	2500065	639
SOL2111-093-08		TEN01907	2504025	640
SOL2111-093-09		TEN01908	2504020	640
SOL2111-093-10		TEN01909	2504015	639
SOL2111-093-11		TEN01912	2504035	640
SOL2211-101-13	2505570	TEN01913		640
SOL2211-103-12	2505520	TEN01914		639
SOL2211-105-11	2505500	TEN01915		639
SOL2311-120-17	2506060	TEN01916	3C8-60217-1	639
SOL2311-123-15	2506050	TX6400K		467
SOL2311-125-14	2505895			
SOL2411-130-19	2506020			
SOL2411-130-21	2505840			
SOL2411-133-17	2506020			
SOL2411-135-15	2506020			
SOL2411-138-13	2505860			
SOL2411-140-11	2505860			
SOL2413-125-19	2506020			

## RO / OEM --> REF

R.O. / OEM	REF		R.O. / OEM	REF		R.O. / OEM	REF	
2500010	CM2500010	638	2506020	SOL2431-135-15	642	688-45970-03-98	SOL3431-130-19	642
2500010	TEN01902	639	2506030	SOL2431-133-17	642	688-45972-02-98	SOL3431-130-21	642
2500050	CM2500050	638	2506030	SOL2431-135-15	642	688-45978-90-98	SOL3431-135-15	642
2500050	TEN01903	639	2506050	SOL2311-123-15	642	6E5-45941-00-EL	SOL3411-130-19	642
2500065	CM2500065	638	2506060	SOL2311-120-17	642	6E5-45941-00-EL	SOL3413-125-19	642
2500065	CM67C-45251-00	636-638	9005655	CM9005655	638	6E5-45943-00-EL	SOL3411-130-21	642
2500065	TEN01906	639	9005655	TEN01900	639	6E5-45943-00-EL	SOL3413-125-21	642
2501300	SOL2111-093-07	642	9005660	TEN01901	639	6E5-45945-00-EL	SOL3411-133-17	642
2504015	CM2504015	638	9005665	CM9005665	638	6E5-45945-00-EL	SOL3413-128-17	642
2504015	TEN01909	639	9005665	TEN01905	639	6E5-45947-00-EL	SOL3411-135-15	642
2504020	TEN01908	640	25040151	CM82795M	639	6E5-45947-00-EL	SOL3413-130-15	642
2504025	TEN01907	640	90056660	CM9005660	638	6E5-45949-00-EL	SOL3411-138-13	642
2504030	TEN01904	639	3C8-60217-1	TEN01916	639	6E5-45949-00-EL	SOL3413-133-13	642
2504035	TEN01912	640	41811-98400	CM55320-98400	638	6E5-45954-00-EL	SOL3411-140-11	642
2505500	SOL2211-105-11	642	41811-98500	CM41811-98500	638	6G1-45941-00-EL	SOL3011-085-09	642
2505520	SOL2211-103-12	642	55300-95500	CM55300-95500	638	6G1-45943-00-EL	SOL3011-085-08	642
2505570	SOL2211-101-13	642	55320-94900	CM55321-94900	638	6G1-45947-00-EL	SOL3011-085-07	642
2505840	SOL2411-130-21	642	55320-94900	CM55321-94900A	638	6G5-45941-00-98	SOL3511-150-15	642
2505840	SOL2413-125-21	642	58.67V4525100	CM67C-45251-00	638	6G5-45941-00-98	SOL3513-148-15	642
2505840	SOL2431-130-21	642	663-45941-01-EL	SOL3311-110-17	642	6G5-45945-01-98	SOL3511-145-19	642
2505860	SOL2411-138-13	642	663-45943-02-EL	SOL3311-110-15	642	6G5-45945-01-98	SOL3513-143-19	642
2505860	SOL2411-140-11	642	663-45945-02-EL	SOL3311-111-13	642	6G5-45947-01-98	SOL3511-148-17	642
2505860	SOL2413-133-13	642	663-45947-02-EL	SOL3311-116-11	642	6G5-45947-01-98	SOL3513-145-17	642
2505895	SOL2311-125-14	642	663-45949-01-EL	SOL3311-110-16	642	6G5-45949-00-98	SOL3511-142-23	642
2506020	SOL2411-130-19	642	663-45952-02-EL	SOL3311-114-12	642	6G5-45949-00-98	SOL3511-143-21	642
2506020	SOL2411-133-17	642	663-45956-01-EL	SOL3311-121-09	642	6G5-45949-00-98	SOL3513-140-21	642
2506020	SOL2411-135-15	642	663-45958-01-EL	SOL3311-111-14	642	6G5-45952-00-98	SOL3512-150-15	642
2506020	SOL2413-125-19	642	664-45945-00-EL	SOL3211-099-10	642	6G5-45952-00-98	SOL3514-148-15	642
2506020	SOL2413-128-17	642	683-45945-00-EL	SOL3111-093-09	642	6K1-45945-01-98	SOL3512-145-19	642
2506020	SOL2413-130-15	642	683-45947-00-EL	SOL3111-093-08	642	6K1-45945-01-98	SOL3514-143-19	642
2506020	SOL2431-130-19	642	683-45952-00-EL	SOL3111-093-10	642	6K1-45947-00-98	SOL3512-148-17	642
2506020	SOL2431-133-17	642	688-45930-02-98	SOL3431-133-17	642	6K1-45947-00-98	SOL3514-145-17	642

# POLÍTICA DE GARANTÍAS RECMAR

Todos los productos comercializados por **Recambios Marinos S.L.U.** deben ser instalados y utilizados por personal competente bajo su exclusiva responsabilidad. **Recambios Marinos S.L.U.** no se responsabiliza de las consecuencias producidas por una instalación defectuosa o inapropiada de ningún artículo que no incluya soluciones de instalación.

El instalador será el responsable de verificar la correcta aplicación de las recomendaciones del fabricante en cuanto a compatibilidades de uso.

Los artículos comercializados por **Recambios Marinos S.L.U.** están amparados por la garantía legal de conformidad, conforme a las condiciones expuestas en el real decreto legislativo 1/2007 de 16 de Noviembre, aprobación del texto refundido de la ley general para la defensa de los consumidores y usuarios.

**Recambios Marinos S.L.U.** distribuye los artículos presentes en sus catálogos únicamente a profesionales, nunca a particulares o cliente final, el importe de la instalación jamás estará incluido en el precio por lo que no será responsable de ésta.

Los artículos comercializados por **Recambios Marinos S.L.U.** disponen de una garantía limitada por defectos de fabricación, los periodos pueden variar entre los 2 años y los 3 meses

## SOLICITUD DE GARANTÍA

La garantía siempre estará sujeta a la valoración final del departamento técnico de **Recambios Marinos S.L.U.** Esta valoración se llevará a cabo en nuestras instalaciones o en caso necesario por el fabricante del artículo, en ambas opciones el artículo tiene que estar físicamente en nuestras instalaciones centrales de Viladecans. El tiempo para la resolución será un máximo de 30 días naturales desde su recepción.

## EXCLUSIONES DE GARANTÍA

**Recambios Marinos S.L.U.** no podrá ser acusado como responsable del defecto ante:

- Desgaste normal del producto.
- Defectos de instalación o uso inadecuado.
- Instalación de un artículo no destinado a ese modelo.
- Daños por causa externa (accidente, rayo, fluctuación de corriente...)
- Defectos y consecuencias relacionadas con el transporte.
- Alteraciones en instalaciones o barcos destinados a la competición.

## GARANTÍA LIMITADA EMBARCACIONES Y PADDLE SURF GOLDENSHIP

**Recambios Marinos S.L.U.** garantiza toda su gama de embarcaciones neumáticas y paddle surf ante cualquier defecto de fabricación durante un periodo de 24 meses (sólo en Europa) únicamente uso particular. Para uso profesional 6 meses.

La garantía limitada será aplicable a defectos en el tejido y sellado, no se aplicará en los siguientes casos:

- Modificación de piezas y partes.
- Falta de mantenimiento, negligencia, accidentes o instalación incorrecta.
- Desgaste y rasgaduras de uso.

Esta garantía limitada no cubrirá costos incidentales originados por: gastos de remolque, almacenaje, botaduras, alquileres de cualquier tipo, pérdidas de tiempo o ingreso, ni otros daños emergentes.

### COMO PROCEDER ANTE UN DEFECTO EN NUESTRA NEUMÁTICA O PADDLE

El primer paso a realizar es la identificación del motivo de la avería. En casos de pérdida de presión es importante localizar el punto o puntos de la pérdida de aire.

El trámite se realizará a través de la página web [www.recambiosmarinos.es](http://www.recambiosmarinos.es) dentro del Área privada, seleccionando

dependiendo del producto, aplicación y tipo de embarcación (lista 7º/ 6º/ 5º), descartando los artículos considerados como consumibles: bombillas, productos eléctricos, baterías y otros que carecen de periodo alguno, si necesita conocer el plazo exacto del producto contacte con el departamento comercial.

Por daños ocasionados en el transporte, se aplicará lo indicado en el artículo 366 de Código de Comercio, que dice : "Dentro de las veinticuatro horas siguientes al recibo de las mercancías, podrá hacerse reclamación contra la empresa de transporte asignada. Transcurridos los términos expresados o pagados los portes, no se admitirá reclamación alguna contra el transportista sobre el estado en que se entregó la mercancía." El material que enviamos diariamente desde **Recambios Marinos S.L.U.** a nuestros clientes es examinado antes de empaquetarse para su perfecta integridad y evitar daños en el transporte. Recuerde que es muy importante inspeccionar las cargas en presencia del transportista. Cuando se observen daños en la caja, deberá incluirse en el albarán de entrega del transportista una mención del tipo (CONFORME MERCANCÍA, SALVO INSPECCIÓN), y deberá ser firmada por usted y el transportista. En caso de recibir material defectuoso por estas causas debe hacerlo constar tanto al transportista como a **Recambios Marinos S.L.U.** para poder reclamar a la empresa de transporte correspondiente.

Para enviar el artículo defectuoso, debe ir a la pagina web [www.recambiosmarinos.es](http://www.recambiosmarinos.es), ir a su cuenta y seleccionar TRAMITAR GARANTÍA dentro del área privada, desde aquí podrá descargar el archivo para la solicitud de garantías de motores y piezas, y seguir las instrucciones.

**Recambios Marinos S.L.U.** no asumirá ningún préstamo de reemplazo durante el proceso de garantía.

En caso de rechazo de la garantía, el cliente tiene la posibilidad de recuperar su artículo defectuoso poniéndose en contacto con nosotros vía e-mail solicitando la devolución del mismo dentro de los 7 días naturales siguientes a la fecha en que se le informó del rechazo de garantía.

**Recambios Marinos S.L.U.** no forma parte de las garantías comerciales anunciadas en ocasiones por los fabricantes.

"**expediente garantía neumáticas GoldenShip**". Es obligatorio adjuntar imágenes del defecto en cuestión y placa del número de serie, copia del albarán de compra y descripción detallada de la avería para iniciar el trámite.

Revisaremos la información y valoraremos el defecto para determinar la aceptación de garantía, en caso de iniciación de trámite les facilitaremos un número de seguimiento o autorización de devolución así como el método de envío. **Recambios Marinos S.L.U.** no aceptará devoluciones de artículos que no hayan sido previamente autorizados.

Nuestras obligaciones quedan limitadas a la reparación o reemplazo de las partes defectuosas resultantes de un defecto de fabricación. Nos reservamos el derecho de modificación de partes fabricadas con anterioridad.

Únicamente el servicio de postventa de Recambios Marinos está autorizado para gestionar las incidencias, no se podrán enviar a reparar artículos sin autorización, en caso de realizarse, el cliente asumirá el 100% los gastos y no podrán ser reclamados.

## RECMAR WARRANTY POLICY

All products sold by **Recambios Marinos S.L.U.** must be installed and used by competent personnel under their exclusive responsibility. **Recambios Marinos S.L.U.** shall not be responsible for the consequences of the faulty or improper installation of any item that does not include installation solutions.

The fitter will be responsible for checking that the manufacturer recommendations have been followed correctly in terms of compatible uses.

Articles sold by **Recambios Marinos S.L.U.** are covered by legal warranty of conformity, in accordance with Royal Legislative Decree 1/2007, of 16 November, approving the recast text of the general law on consumer and user protection.

**Recambios Marinos S.L.U.** distribute the products only to professionals and never to privates of final clients. The cost of installing the part would never be included in the price for which reason, **Recambios Marinos S.L.U.** would never be responsible for its installation.

Articles sold by **Recambios Marinos S.L.U.** are covered by warranty for manufacturing defects for a limited period of time that may vary between 2 years and 3 months, depending on the

product, application and type of boat it is installed on (7th/6th/5th list), except for the articles considered consumable, light bulbs, electrical products, batteries and others that are not covered at all. For information on the exact warranty period of an article, please contact the Sales Department.

In the case of damage caused during shipping, article 366 of the Code of Commerce will apply. The article says: "Claims to the delivery company may be made within 24 hours from receiving the goods. Once this term has elapsed, or the freight costs have been paid, claims to the delivery company with regard to the condition of the goods can no longer be made." The goods that **Recambios Marinos S.L.U.** sends every day to its customers are examined before being packed to ensure their perfect integrity and avoid damage during shipping. Remember that it is essential to check the goods in the presence of the dispatcher. If the package is damaged, the dispatcher's delivery note must mention what type (CONFORMING GOODS, UNLESS INSPECTED), and must be signed by you and by the dispatcher. If you receive damaged goods for these reasons you must notify both the dispatcher and **Recambios Marinos S.L.U.** to be able to make the claim to the relevant delivery company.

## WARRANTY CLAIMS

Warranties are always subject to **Recambios Marinos S.L.U.** Technical Department's assessment. The assessment will be carried out on **Recambios Marinos S.L.U.**'s premises or, if necessary, by the article's manufacturer. In both cases, the article must be physically on **Recambios Marinos S.L.U.**'s premises in Viladecans. Assessment time will not exceed 30 calendar days from receiving the article.

To return the faulty item, visit [www.recambiosmarinos.es](http://www.recambiosmarinos.es), go to your account and select PROCESS WARRANTY in the private section. From there you will be able to download the file to claim the warranty of engines and parts and follow the instructions.

**Recambios Marinos S.L.U.** will not charge for the loan of the replacement during the warranty process.

## WARRANTY EXCLUSIONS

**Recambios Marinos S.L.U.** shall not be responsible for product faults in the following cases:

- Normal wear and tear of a product. Installation faults or improper use.
- Installation of an article not designed for the model in question.
- Damage due to external causes (accidents, lightning, power surges...)
- Defects and consequences of transport.
- Alterations to installations or to boats intended for competitions.

If the warranty is refused, the customer may retrieve the faulty article by contacting **Recambios Marinos S.L.U.** via email and requesting that the article is returned to them within 7 calendar days from the day the warranty was refused.

**Recambios Marinos S.L.U.** does not apply the warranties offered from time to time by manufacturers.

## GOLDENSHIP BOATS AND PADDLE SURF LIMITED WARRANTY

**Recambios Marinos S.L.U.** guarantees its full range of inflatable/rib boats and paddle surf of any manufacturing defect for a period of 24 months (only in Europe) for private use only. Commercial use 6 months.

The limited warranty will be applicable to defects in the fabric and sealing, but will not apply in the following situations:

- Modification of parts and components.
- Lack of maintenance, negligence, accidents or improper installation.
- Wear and tear of use.

This limited warranty will not cover incidental costs arising from: towing expenses, storage, launching, rents of any kind, loss of time or income, or other damages emerging.

### HOW TO PROCEED IF YOU FIND A DEFECT IN ONE OF OUR BOATS / PADDLE SURF

Identify the reason for the breakdown, in cases of pressure loss. It is important to locate the point or points of air loss.

The claim must be done through the private area of the the **Recambios Marinos** website, [www.recambiosmarinos.es](http://www.recambiosmarinos.es) by selecting the file "**Goldenship boats warranty**".

It is mandatory to attach images when you send the claim to **Recambios Marinos S.L.U.** by e-mail, and a detailed explanation of the problem as well as copy of the plate with the model and serial number and copy of the purchase invoice.

Our obligations are limited to the repair or replacement of defective parts resulting from a manufacturing defect. We reserve the right to modify parts previously manufactured.

Only the **Recambios Marinos S.L.U.** service department is authorized to handle the warranty claims and authorize any repair. Items cannot be sent to repair without authorization of **Recambios Marinos S.L.U.**, Otherwise the client would have to assume 100% of the expenses and would be automatically out of warranty.



## POLITICA DI GARANZIE RECMAR

Tutti i prodotti commercializzati da **Recmar S.R.L.** devono essere installati e utilizzati da personale competente sotto la sua esclusiva responsabilità. **Recmar S.R.L.** non è responsabile per le conseguenze di un'installazione difettosa o inadeguata di qualsiasi articolo che non includa soluzioni di installazione.

L'installatore è responsabile della verifica della corretta applicazione delle raccomandazioni del fabbricante in materia di compatibilità d'uso.

Gli articoli commercializzati dalla **Recmar S.R.L.** sono coperti dalla garanzia legale di conformità, conforme alle condizioni enunciate nel regio decreto legislativo 1/2007 del 16 novembre, approvazione del testo consolidato della legge generale per la difesa dei consumatori e degli utenti.

**Recmar S.R.L.** distribuisce gli articoli presenti nei suoi cataloghi solo a professionisti, mai a privati o cliente finale, l'importo dell'impianto non sarà mai incluso nel prezzo e quindi non sarà responsabile di quest'ultimo.

Gli articoli commercializzati dalla **Recmar S.R.L.** dispongono di una garanzia limitata per difetti di fabbricazione, i periodi possono variare da 2 anni a 3 mesi a seconda del prodotto applicazione

e tipo di imbarcazione (elenco 7<sup>a</sup>/ 6<sup>a</sup>/ 5<sup>a</sup>), scartando gli articoli considerati come consumabili lampadine, prodotti elettrici, batterie e altri che non hanno alcun periodo di tempo, se avete bisogno di conoscere il tempo esatto del prodotto contattare il reparto commerciale.

Per i danni causati al trasporto si applica l'articolo 366 del codice di commercio che recita: "Entro 24 ore dal ricevimento delle merci, può essere presentato un reclamo nei confronti della società di trasporto designata. Alla scadenza dei termini espressi o pagati, non sono ricevibili reclami contro il trasportatore in merito allo stato in cui la merce è stata consegnata." Il materiale che inviamo quotidianamente da **Recmar S.R.L.** ai nostri clienti viene esaminato prima di essere confezionato per la sua perfetta integrità ed evitare danni al trasporto. Si ricorda che è molto importante ispezionare i colli alla presenza del vettore. In caso di danneggiamento della cassa, sul bollettino di consegna del trasportatore deve figurare un'indicazione del tipo (CONFORME MERCE, SALVO ISPEZIONE) e deve essere firmato dall'utente e dal trasportatore, in caso di ricezione di materiale difettoso per questi motivi deve essere messo a verbale sia al trasportatore che alla **Recmar S.R.L.** per poter reclamare all'impresa di trasporto interessata.

## RICHIESTA DI GARANZIA

La garanzia sarà sempre soggetta alla valutazione finale del Dipartimento Tecnico della **Recmar S.R.L.** Questa valutazione sarà effettuata presso la nostra sede o, se necessario, dal fabbricante dell'articolo, in entrambe le opzioni l'articolo deve essere fisicamente nella nostra sede centrale di Viladecans, il tempo per la risoluzione è un massimo di 30 giorni di calendario dalla ricezione.

Per inviare l'articolo difettoso, è necessario andare al sito [www.recmar.it](http://www.recmar.it), andare al tuo account e selezionare la GARANZIA all'interno del settore privato, da qui è possibile scaricare il file per la richiesta di garanzie di motori e parti e seguire le istruzioni.

**Recmar S.R.L.** non assumerà alcun prestito di sostituzione durante il processo di garanzia.

## ESCLUSIONI DI GARANTÍA

**Recmar S.R.L.** non può essere accusato come responsabile del difetto di fronte a:

- Normale usura di un prodotto.
- Difetti di installazione o uso improprio.
- Installazione di un articolo non destinato a quel modello.
- Danni dovuti a cause esterne (incidente, fulmine, fluttuazione di corrente...)
- Difetti e conseguenze connesse al trasporto.
- Modifiche in impianti o barche destinati alla competizione.

In caso di rifiuto della garanzia, il cliente ha la possibilità di recuperare il suo articolo difettoso contattandoci via e-mail e richiesta di rimborso entro 7 giorni di calendario dalla data in cui viene informato del rifiuto della garanzia.

**Recmar S.R.L.** non fa parte delle garanzie commerciali annunciate a volte dai produttori.

## GARANZIA LIMITATA BARCHE E PADDLE SURF GOLDENSHIP

**Recmar S.R.L.** garantisce l'intera gamma di imbarcazioni pneumatiche e paddle surf contro qualsiasi difetto di fabbricazione per un periodo di 24 mesi (solo in Europa) esclusivamente per uso privato. Per uso professionale 6 mesi.

La garanzia limitata si applica ai difetti di tessuto e di tenuta, non si applica nei seguenti casi:

- Modifica di parti e pezzi.
- Mancanza di manutenzione, negligenza, incidenti o installazione errata.
- Usura e strappi di utilizzo

Questa garanzia limitata non copre i costi incidentali derivanti da: costi di rimorchio, deposito, varo, noleggio di qualsiasi tipo, perdite di tempo o entrate, o altri danni emergenti.

### COME PROCEDERE A UN DIFETTO NELLA NOSTRA PNEUMATICA/ PADDLE

Il primo passo da fare è identificare il motivo dell'avaria, in caso di perdita di pressione è importante individuare il punto o i punti della perdita d'aria.

Il tramite sarà effettuato attraverso il sito Web di Recambios Marinos [www.recmar.it](http://www.recmar.it) all'interno dell'area privata, selezionando il "dossier garanzia pneumatiche GoldenShip". È obbligatorio allegare immagini del difetto in questione e targhetta del numero di serie, copia della bolla di acquisto e descrizione dettagliata del guasto per avviare la procedura, se necessario.

**Recmar S.R.L.** non accetterà restituzioni di articoli che non sono stati precedentemente autorizzati.

I nostri obblighi sono limitati alla riparazione o sostituzione delle parti difettose derivanti da un difetto di fabbricazione. Ci riserviamo il diritto di modificare parti prodotte in precedenza.

Solo il servizio di post-vendita della **Recmar S.R.L.** è autorizzato a gestire gli eventi, non possono essere inviati a riparare articoli senza autorizzazione, in caso di realizzazione il cliente assumerà il 100% delle spese e non potranno essere reclamati.

## POLITIQUE DE GARANTIE RECMAR

Tous les produits vendus par **Recambios Marinos S.L.U.** doivent être installés et utilisés par du personnel compétent sous sa seule responsabilité.

**Recambios Marinos S.L.U.** n'est pas responsable des conséquences d'une installation défectueuse ou inappropriée de tout élément n'incluant pas les solutions d'installation.

L'installateur sera responsable de la vérification de l'application correcte des recommandations du fabricant concernant la compatibilité d'utilisation.

Les articles vendus par **Recambios Marinos S.L.U.** bénéficient de la garantie légale de conformité, conformément aux conditions énoncées dans le décret législatif royal 1/2007 du 16 novembre, portant approbation du texte consolidé de la loi générale de la défense des consommateurs et des utilisateurs.

Les articles vendus par **Recambios Marinos S.L.U.** ont une garantie limitée pour les défauts de fabrication, les périodes peuvent varier de 2 ans à 3 mois en fonction de l'application du produit et du type de navire où ils ont été installés (7ème / 6ème / 5ème liste), excluant les articles considérés comme des consommables, ampoules, produits électriques, batteries et autres.

Si vous ne connaissez pas la durée de garantie exacte du produit, contactez le service commercial.

Pour les dommages causés au cours du transport, les dispositions de l'article 366 du code de commerce seront appliquées, ce qui stipule:

Vingt-quatre heures maximum après la réception de la marchandise, une réclamation doit être adressée à la société de transport.

Après que les conditions aient été exprimées ou que le fret eu été payé, aucune réclamation ne sera acceptée contre le transporteur auprès de l'État.

Lorsque la marchandise a été livrée. Le matériel que nous envoyons quotidiennement de **Recambios Marinos S.L.U.** à nos clients est examiné avant l'emballage pour une intégrité parfaite et éviter les dommages de transport. N'oubliez pas qu'il est très important d'inspecter le chargement en présence du transporteur.

Lorsque des dommages sont constatés sur le colis, ils doivent figurer sur le bon de livraison du transporteur.

Une mention du type (EN FONCTION DE LA MARCHANDISE, SAUF INSPECTION), et doit être signé par vous et le transporteur, s'il est reçu défectueux le matériel doit être enregistré pour ces raisons à la fois par le transporteur et par **Recambios Marinos S.L.U.** pour qu'une réclamation soit faite la compagnie de transport correspondante.

## DEMANDE DE GARANTIE

La garantie sera toujours soumise à l'évaluation finale du service technique de **Recambios Marinos S.L.U.** Cette évaluation sera effectuée dans nos installations ou, si nécessaire, par le fabricant de l'article, dans les deux cas, l'article doit être physiquement dans nos locaux de Viladecans, le délai de résolution sera de 30 jours maximum à partir de sa réception.

Pour envoyer l'article défectueux, vous devez vous rendre sur le site [www.recambiosmarinos.es](http://www.recambiosmarinos.es), accéder à votre compte et sélectionner

### PIECES DE RETOUR.

Dans l'espace privé, vous pouvez télécharger le fichier pour demander des garanties de moteurs et de pièces et suivre les instructions.

Si tel est votre souhait, **Recambios Marinos S.L.U.** n'assumera aucun prêt de remplacement pendant le processus de garantie.

## EXCLUSIONS DE GARANTIE

**Recambios Marinos S.L.U.** ne sera pas responsable des défauts suivants:

- Usure normale d'un produit.
- Défauts d'installation ou d'utilisation inadéquate.
- Installation d'un article non destiné à ce modèle.
- Dommages dus à une cause externe (accident, foudre, fluctuation de courant...)
- Défauts et conséquences liés au transport.
- Modifications d'installations ou de bateaux destinés à la compétition.

En cas de refus de la garantie, le client a la possibilité de récupérer son article défectueux en nous contactant par courrier électronique pour demander le retour à ses frais de celui-ci dans les 7 jours calendaires suivant la date à laquelle vous avez été informé du rejet de la garantie.

**Recambios Marinos S.L.U.** ne participe pas à des garanties commerciales parfois annoncées par les fabricants.

## LIMITE DE GARANTIE EMBARCATIONS ET PADDLE GOLDENSHIP

**Recambios Marinos S.L.U.** garantie sa gamme complète de bateaux gonflables et de paddle surf contre tout défaut de fabrication pendant une durée de 24 mois (uniquement en Europe) exclusivement pour usage particulière. Pour usage professionnel 6 mois.

La limite de garantie sera applicable aux défauts du tissu et de l'étanchéité, et elle ne s'appliquera pas dans les cas suivants :

- Modification de pièces ou partie.
- Manque d'entretien, négligence, accidents ou mauvaise installation.
- Usure d'usage.

Cette garantie limitée ne couvrira pas les frais accessoires résultant : Frais de stockage, remplacement, loyer de toute nature perte de temps ou de revenu, ou d'autre dommage émergent.

La procédure se fera via notre site internet [www.recambiosmarinos.es](http://www.recambiosmarinos.es), dans votre espace privé en sélectionnant le dossier "**garantie pneumatique Goldenship**". Il est obligatoire de joindre des photos du défaut en question et de la plaque du numéro de série. Il faut joindre également la copie du bon de livraison ou de la facture d'achat et faire une description détaillée de la panne pour démarrer le processus si nécessaire.

**Recambios Marinos S.L.U.** n'acceptera pas les retours des articles qui n'ont pas été préalablement autorisés. Notre obligation se limite à la réparation ou le remplacement des pièces défectueuses résultant d'un défaut de fabrication. Nous nous réservons le droit de modifier les pièces fabriquées précédemment.

Seul le service après-vente de **Recambios Marinos S.L.U.** est autorisé à gérer les incidents. Les articles ne peuvent pas être envoyés en réparation sans autorisation. Dans le cas contraire, le client assumera 100% des dépenses et ne pourra rien réclamer.

### COMMENT PROCEDER AVEC UN DEFAUT SUR NOS PNEUMATIQUES ET PADDLE

La première étape consiste à identifier le motif de la panne. En cas de perte de pression, il est important de localiser le ou les points par lesquels l'air s'échappe.



## BARCELONA

Jocelyn Bell, 26  
Pol. Ca n'Alemanya  
08840 Viladecans (Barcelona)  
Tel. 902 10 85 85 - 93 633 34 80  
Fax 93 662 66 59

International  
phone: (+34) 93 662 66 55  
Fax (+34) 93 662 66 59

info@recambiosmarinos.es  
www.recambiosmarinos.es

## GIRONA

C/ Gironés, 5  
Pol. Ind. El Plà  
17486 Castelló d'Empúries (Girona)  
Tel. (+34) 972 158 809

girona@recmar.es

## CANARIAS

Laura Grote de la Puerta, 3, Nave 5  
Pol. Industrial El Mayorazgo  
38110 Santa Cruz de Tenerife  
Tel. (+34) 922 621 499

canarias@recmar.es

## ITALIA

RECMAR SRL  
Via Israele 10 H  
Zona Industriale Settore 7  
07026 Olbia (OT)

Tel. (+39) 0789 51962  
Fax (+39) 0789 600177  
sales@recmar.it